

## Shelves (Fixed) - Panel Mount (Single Pair of Panel Rails)



**Vented**  
(7" Deep - 1U Shown)















**Unvented**  
(7" Deep - 1U Shown)

### Panel Rail Mounted - *Light Duty (Maximum 40 - 80 pound loads)* Fixed Chassis/Shelf (Vented or Unvented)

- Allows easy rack mounting of narrow equipment or items that do not have rack mounting capabilities.
- Shelves feature formed 16-gauge steel construction
- Choice of four heights - 1.75"(1U), 3.5"(2U) or 5.25"(3U) of panel space
- Front & back edge folded - acting as both stiffeners and equipment retainers..
- Weight load tested: (1U-40 pounds, 2U-65 pounds, 3U-80 pounds)
- Mounts to rack rails either as an internal shelf or external shelf/work area
- Choice of two depths - 7" or 14.5"
- Available in either vented or unvented versions
- Shelves include tie down slots on each side & four tie down holes.
- Perfect for our smaller desk top racks (ex: [RCBS](#), [RCHS](#), [RCHV](#), [RRTT](#), [1459](#) series)
- Rugged textured - black powder paint finish
- Requires mounting [hardware](#)

### UNVENTED

Part Number	Panel Height		PDF Reader File	AutoCAD .dxf File (zipped)	3D Solid Model .stp files (zipped)	Shelf Depth	Weight Load Rating (Pounds)	Stiffener Lip(s) Folded
	Inches	Units						
<b>19" Rack Mount</b>								
<a href="#">RASU190107UBK1</a>	1.75	1	 77K	 50K	 49K	7"	40	Up (front & back)
<a href="#">RASU190107DBK1</a>	1.75	1	 74K	 43K	 38K	7"	40	Down (front & back)
<a href="#">RASUL190314BK1</a>	3.50	2	 80K	 46K	 42K	14.5"	65	Up (back only)
<a href="#">RASUL190514BK1</a>	5.25	3	 84K	 46K	 42K	14.5"	80	Up (back only)

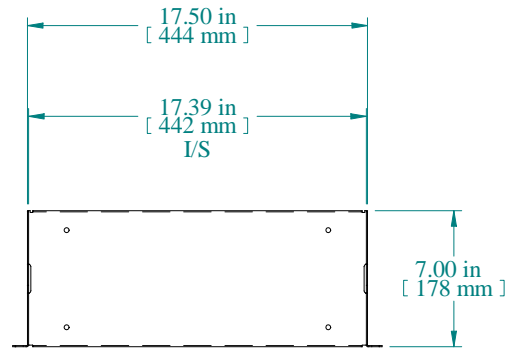

TOP VIEW

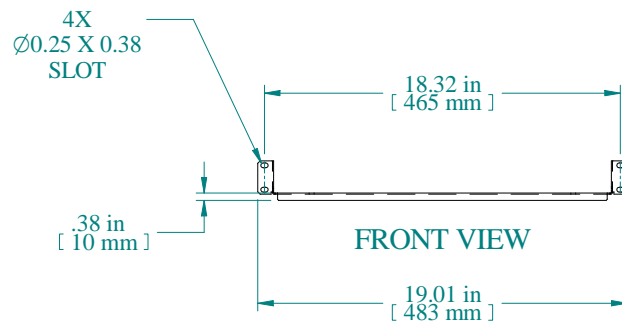
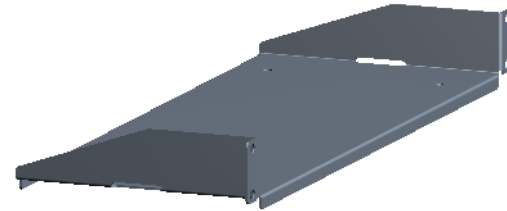

FRONT VIEW

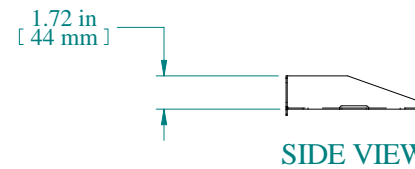

SIDE VIEW

PART NUMBERS	
RASU190107DBK1	PAINTED BLACK TEXTURED

NOTES
Maximum Weight 40 lb Mounting Hardware not Supplied with Shelf

Data subject to change without notice. Isometric drawing not to scale.

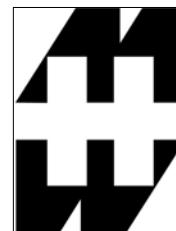

**HAMMOND  
MANUFACTURING™**

[www.hammondmfg.com](http://www.hammondmfg.com)

PART NO. RASU190107D