

[Home](#)

[Products](#)

[Distributors](#)

[Technical](#)

[Contact Us](#)

[Other Options](#)

Path: [Home](#) > [Enclosure Index](#) > [ROLEC-HAMMOND Aluminum Product Index](#) > [EMI/RFI Watertight](#)



[click to enlarge](#)



[Working example - click to enlarge](#)



















Key Features:











- Material - Aluminum die-cast: G AI SI 12 / DIN 1775
- Shallow lid, deep body
- Captive stainless steel lid screws
- Neoprene oil and petrol resistant gasket standard. (-40°C up to +80°C)
- EMI/RFI gasket is **NOT** required as lid to box connection is **INSIDE** the gasket seal. A patented system with **special designed "teeth"** in the enclosure bottom provide a lasting and corrosion

secure shield.

- Degree of protection NEMA 4X, IP66, DIN 40050
- Temperature Range (-40°C up to +80°C)
- Separate channel system (outside the seal)
- Special developed external mounting feet made from zinc-die-cast. Can be turned through 90°. The fastening holes have engagement lugs for this purpose. **(See accessories)**
- All sizes have inner blind holes. A mounting plate made of zinc-plated steel is available
- Textured polyester powder coat, light beige/grey RAL 7032. (Special paint finishes in a variety of colors are available)
- CSA certified, Type 4, for use with industrial control equipment



Part No.	Reader File	 Drawing File Size	AutoCAD .dxf File	.dxf or .zip File Size	Units	Width	Length	Depth (Including Lid)
						A	B	C
R111-081-000		62K		53K	mm	84	79	44
					inches	3.3	3.1	1.8
R110-081-000		62K		54K	mm	84	79	67
					inches	3.3	3.1	2.7
R111-082-000		33K		144K	mm	84	129	44
					inches	3.3	5.2	1.8
R110-082-000		33K		145K	mm	84	129	67
					inches	3.3	5.2	2.7
R111-083-000		32K		137K	mm	84	179	44
					inches	3.3	7.2	1.8
R110-083-000		33K		148K	mm	84	179	67
					inches	3.3	7.2	2.7
R111-121-000		64K		52K	mm	125.5	127.5	60
					inches	5	5	2.4
R110-121-000		64K		54K	mm	125.5	127.5	90
					inches	5	5	3.6
R111-123-000		34K		156K	mm	125.5	225.5	60
					inches	5	9	2.4
R110-123-000		34K		156K	mm	125.5	225.5	90

					inches	5	9	3.6
R111-161-000		64K		53K	mm	166	166	60
					inches	6.5	6.5	2.4
R110-161-000		64K		54K	mm	166	166	100
					inches	6.5	6.5	4
R111-162-000		33K		147K	mm	166	266	66
					inches	6.5	10.5	2.6
R110-162-000		33K		147K	mm	166	266	100
					inches	6.5	10.5	4

EMC tested by the University of Hanover

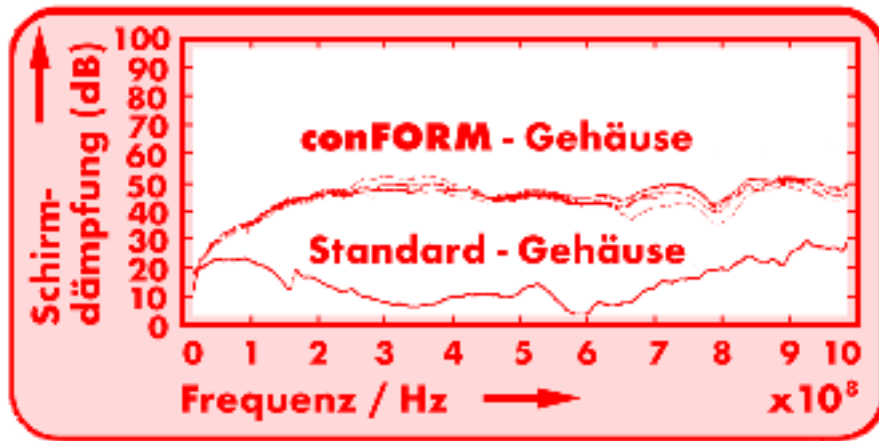

Features (by photo):

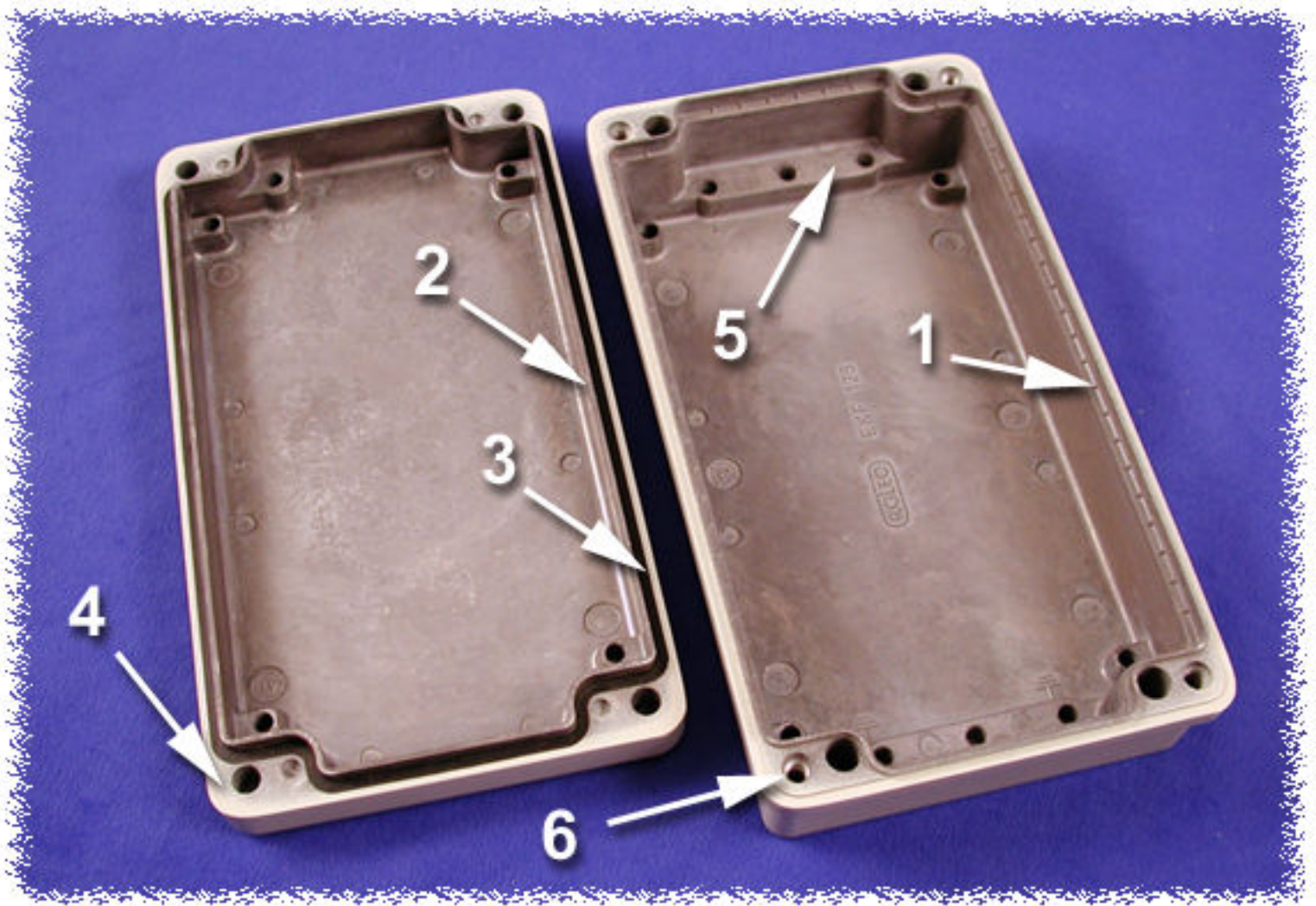

1 - EMI/RFI enclosure body connection --to lid (see #2 above) is made **INSIDE** the gasket seal (see #3). This eliminates expensive conducting gaskets and the corrosion problems that can appear later...

2 - Lid EMI/RFI edge (link here to [lid close up](#)) extends into enclosure and contacts "**teeth**" (see #1 above) in enclosure body for a positive contact...

3 - Gasket (thermoplastic, forprene, silicon free material) outside of EMI/RFI contact points and inside of lid & mounting holes. No need for expensive conducting gasket (see #1 above)...

4 - Screws and mounting holes outside of gasket seal...

5 - Internal mounting shelves placed along both sides of enclosure include blind holes and grounding screws. There are many mounting holes for self tapping screws in both the enclosure & the lid. Can also be used for mounting P.C. boards or plates..

6 - Enclosure holes threaded for easy installation and repetitive assembly & disassembly...

Exactly what you are looking for???

Link to our stocking distributors - most have "on-line" pricing, stock check and ordering!!!

Our Distributors

Order from your favorite distributor



HOME PAGE 

NOTES

MATERIAL - DIECAST ALUMINUM ALLOY
 - FOUR M6 CAPTIVE SCREWS

POWDER COATED - Col. RAL 7032
 POLYURETHANE GASKET
 -40°C TO +80°C TEMP. RANGE

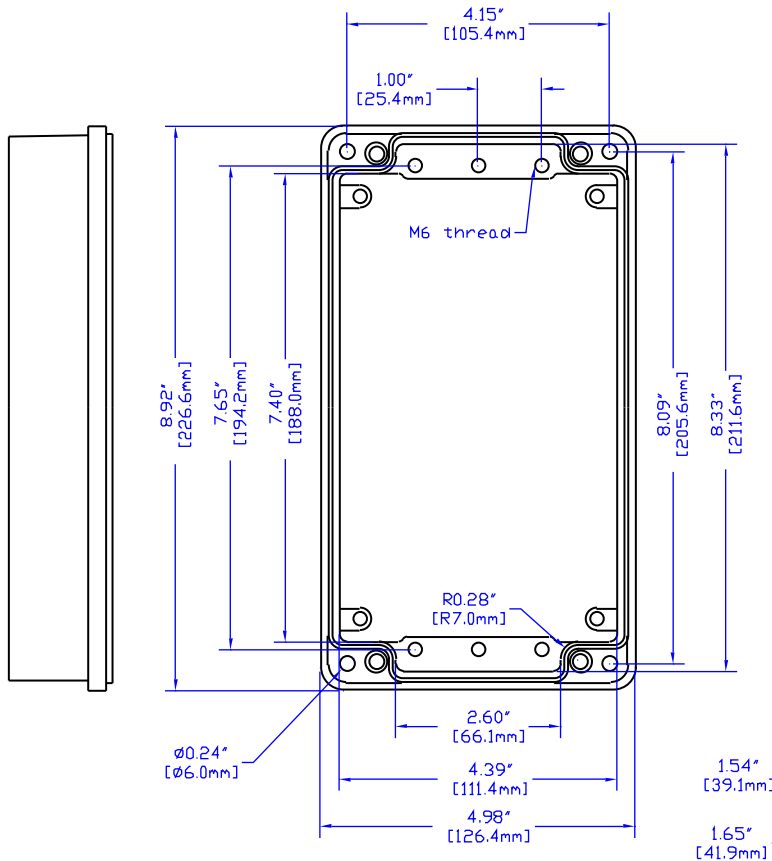
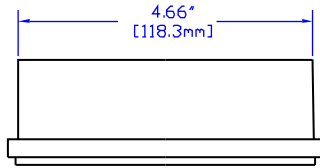

VIEW OF BOX (LID REMOVED)

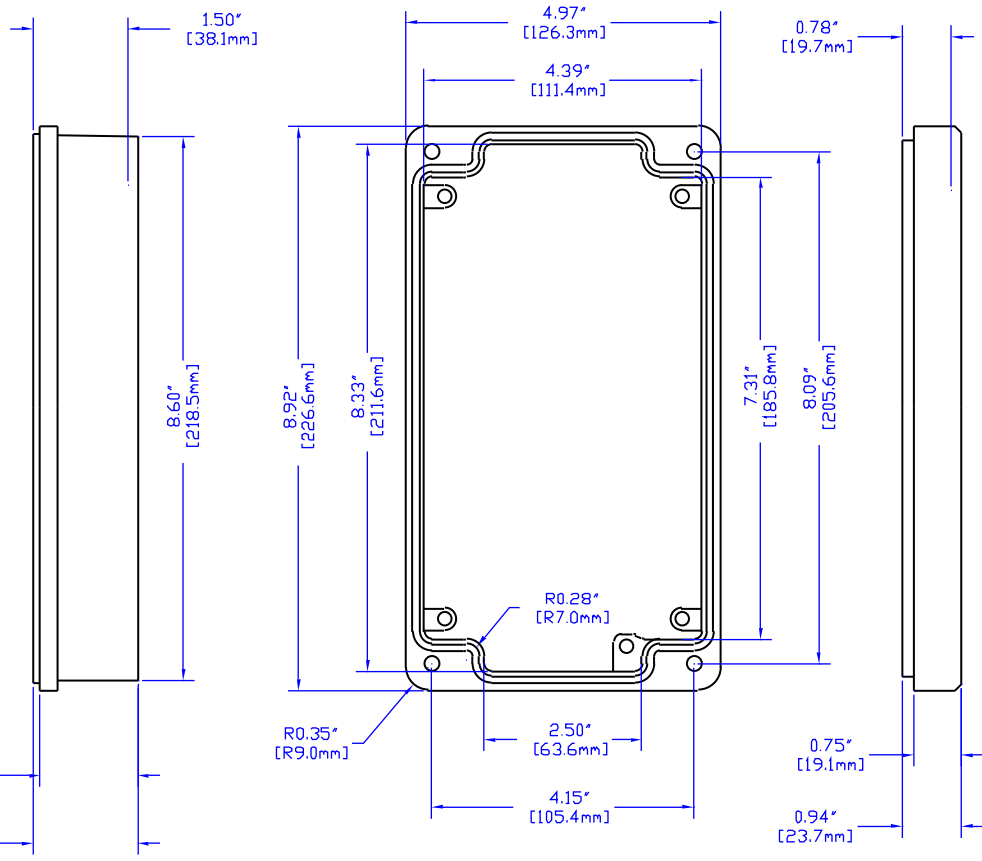
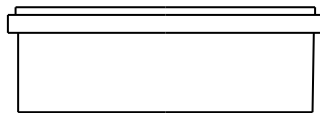

VIEW OF LID (INSIDE)



HAMMOND MANUFACTURING

R111-123-000

CANADA - PH (519) 886 7170 - FAX (519) 886 8311
 U.S.A. - PH (716) 631 5700 - FAX (716) 631 1156