

# OKA/KU Door Mounting Kit for KU Switches

Designed for fast and easy assembly.

Environmental ratings: NEMA Type 4X, IP66; 3 padlock locations.



Shown with switch and display plate.  
(sold separately)



Lockable with up to 3 padlocks.



Drill  
Template &  
Instructions  
Included

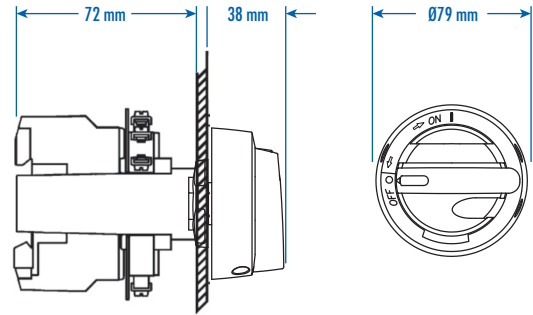
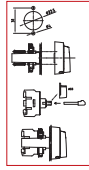

Cat. No. (Black Handle)	Cat. No. (Yellow/Red Handle)	No. of aux. switches	For use with
OKA/KU LK10	OKA/KU LK10 Y/R	0	3 Pole KU switch
OKA/KU LK10 1.V	OKA/KU LK10 1.V Y/R	1	3 Pole KU switch
OKA/KU LK10 2.V	OKA/KU LK10 2.V Y/R	2	3 Pole KU switch
OKA/KU4P LK10	OKA/KU4P LK10 Y/R	0	4 Pole KU switch
OKA/KU4P LK10 1.V	OKA/KU4P LK10 1.V Y/R	1	4 Pole KU switch
OKA/KU4P LK10 2.V	OKA/KU4P LK10 2.V Y/R	2	4 Pole KU switch

## Assembly Instructions

Use the enclosed drill template to prepare the door for door mounting kit assembly.  
Discard the switch handle on the disconnect switch and follow photo-illustration below.

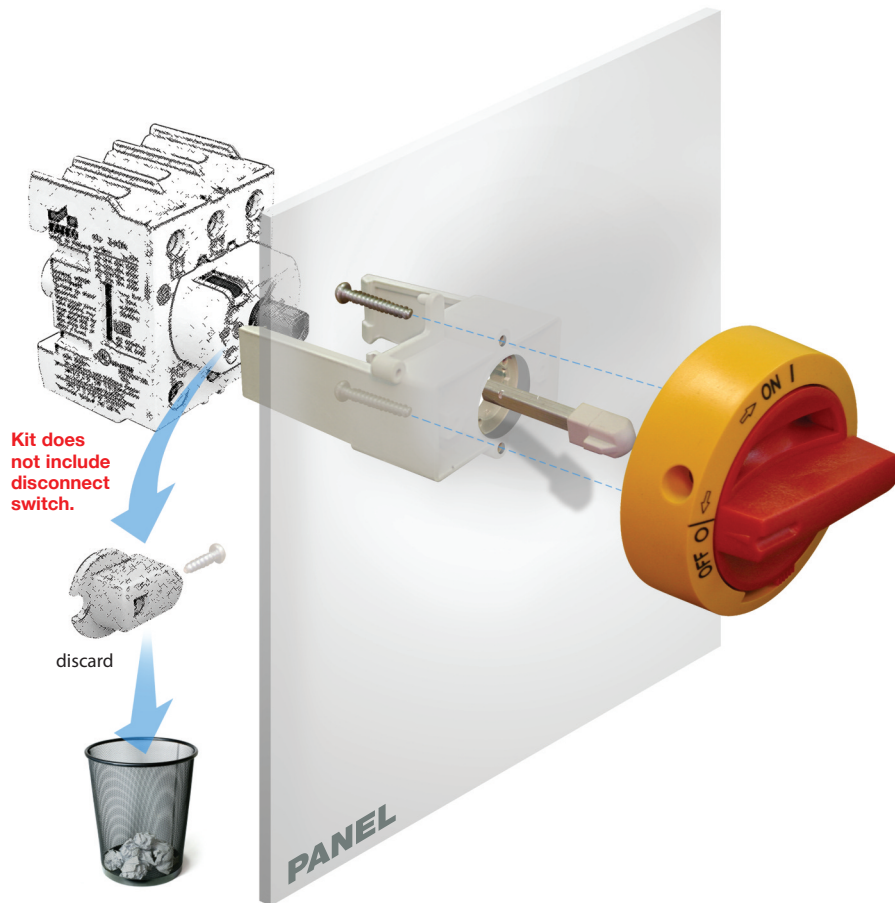

1. Drill the required holes in the door.

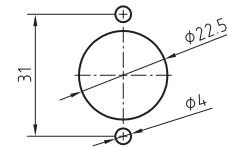

2. Fix the handle and the OKA door mounting kit to the door.

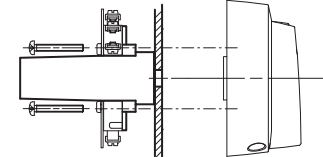

3. Remove position indicator from the switch if applicable. Press the shaft (L=52AD11 mm) into the switch. Connect the wires to the terminals.

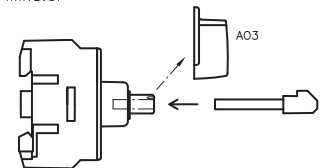

4. Turn the switch to OFF-position (0). Push the switch in place until the snap-on grips are firmly clipped on both sides of the switch.

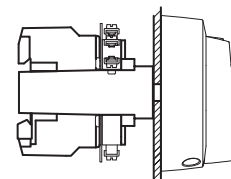

**WARNING:**  
Auxiliary contact may be broken if pushed on switch in ON-position (1).

**Dimensions** (to convert to inches multiply by 0.03937)

# OKA Door Mounting Kit for KU Switches

Designed for fast and easy assembly.

Environmental ratings: IP65; 3 padlock locations.



Shown with switch and display plate.  
(sold separately)



Lockable with up to 3 padlocks.



Drill  
Template &  
Instructions  
Included

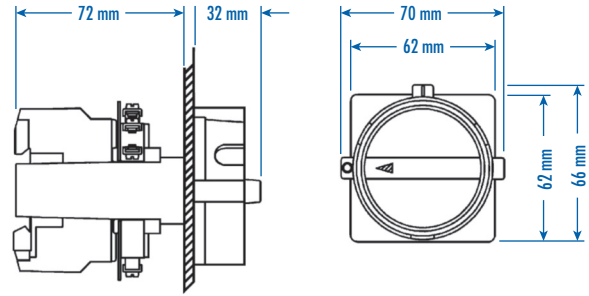
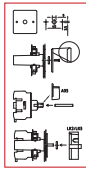

Cat. No. (Black Handle)	Cat. No. (Yellow/Red Handle)	No. of aux. switches	For use with
OKA 0.V	OKA 0.V.Y/R	0	3 Pole KU switch
OKA 1.V	OKA 1.V.Y/R	1	3 Pole KU switch
OKA 2.V	OKA 2.V.Y/R	2	3 Pole KU switch

## Assembly Instructions

Use the enclosed drill template to prepare the door for door mounting kit assembly.  
Discard the switch handle on the disconnect switch and follow photo-illustration below.

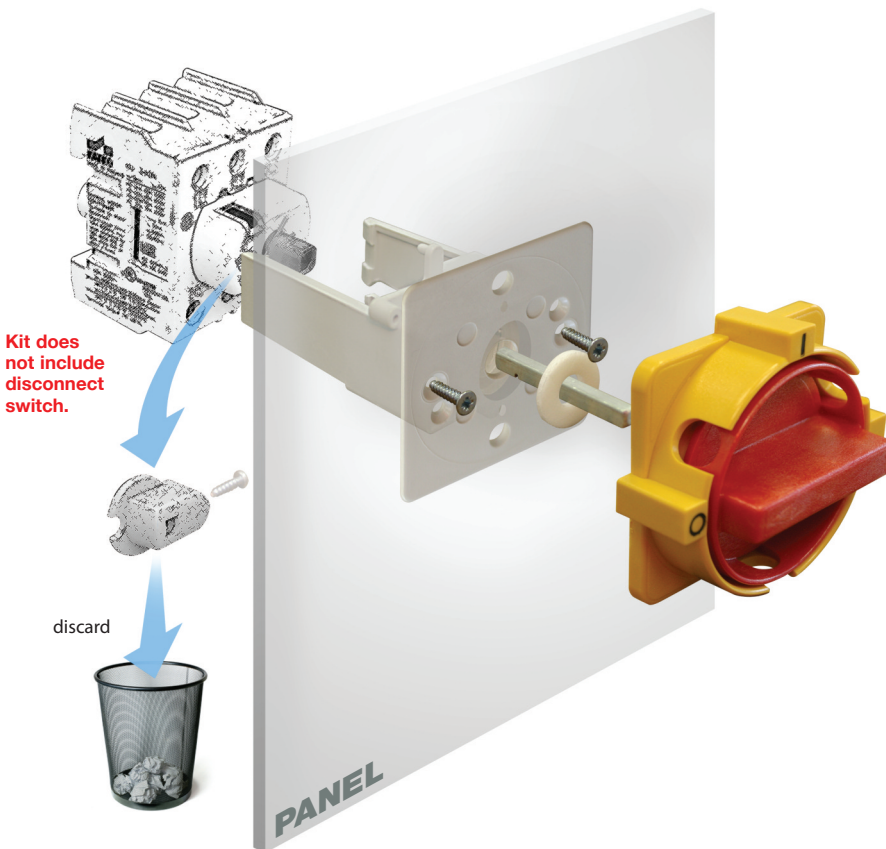

1. Drill required holes in the door/side of panel.

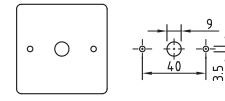

2. Fix the base plate and the OKA door mounting kit to the door. Please observe, that washer have been properly placed between door and base plate.

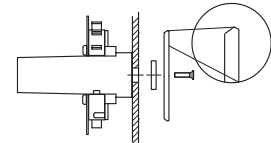

3. Remove position indicator from the switch if applicable. Press the shaft (L=43 mm) into the switch. Connect the wires to the terminals.

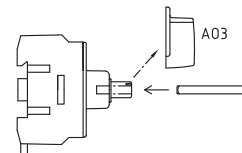

4. Turn the switch to off-position (0). Push the switch in place until the snap-on grips are firmly clipped on both sides of the switch.

5. Install the handle on top of the base plate. Please observe, that washer have been properly placed between plate and handle.

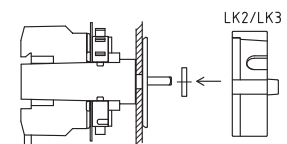

WARNING:  
Auxiliary contact may be broken if pushed on switch in on-position (1).

**Dimensions** (to convert to inches multiply by 0.03937)

# OKA/VKA Door Mounting Kit for VKA Switches

Designed for fast and easy assembly.

Environmental ratings: NEMA Type 4X, IP66; 3 padlock locations.

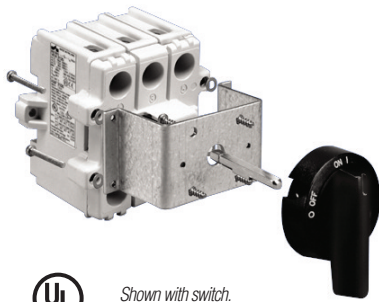

Lockable with up to 3 padlocks.



Drill Template & Instructions Included

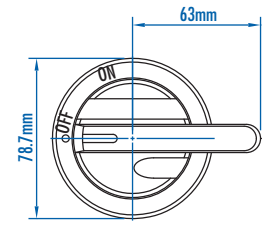
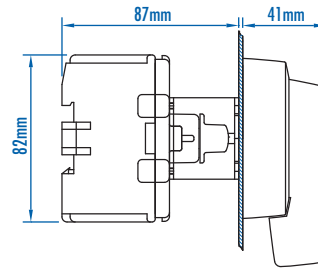
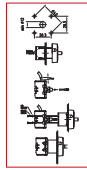

Shown with switch. (sold separately)

Cat. No. (Black Handle)	Cat. No. (Yellow/Red Handle)	No. of aux. switches	For use with
OKA/VKA 0.V	OKA/VKA 0.VY/R	0	3 Pole VKA switch
OKA/VKA 1.V	OKA/VKA 1.VY/R	1	3 Pole VKA switch
OKA/VKA 2.V	OKA/VKA 2.VY/R	2	3 Pole VKA switch
OKA/VKA4P 0.V	OKA/VKA4P 0.VY/R	0	4 Pole VKA switch
OKA/VKA4P 1.V	OKA/VKA4P 1.VY/R	1	4 Pole VKA switch
OKA/VKA4P 2.V	OKA/VKA4P 2.VY/R	2	4 Pole VKA switch

## Assembly Instructions

Use the enclosed drill template to prepare the door for door mounting kit assembly. Discard the switch handle on the disconnect switch and follow illustration below.

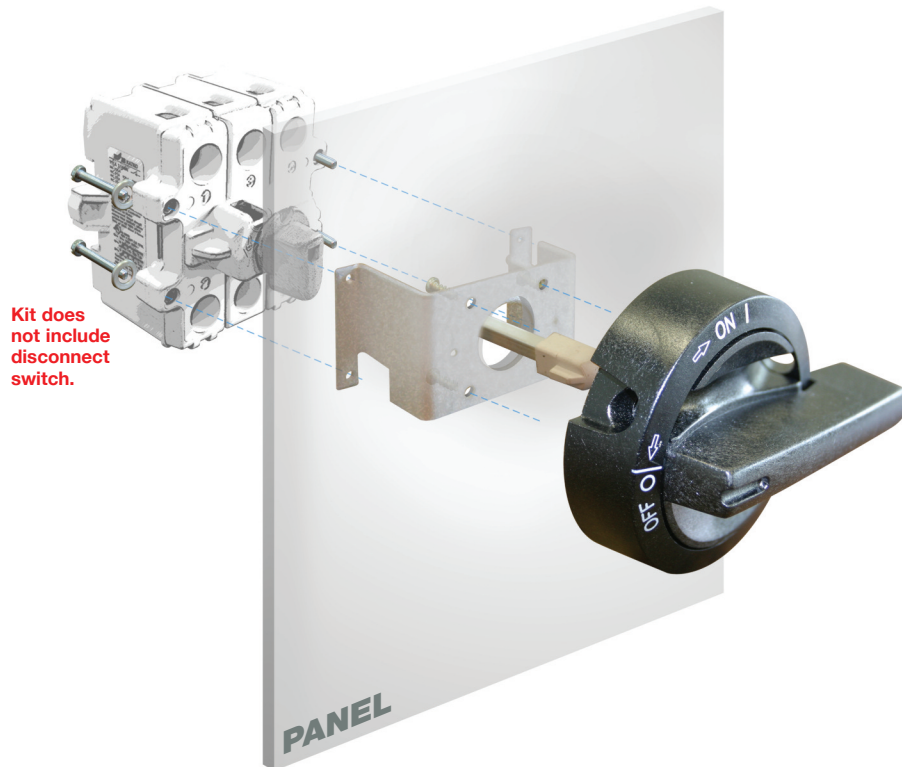

1. Drill the required holes in the door.
2. Fix the handle LK11 and the OKA door mounting kit to the door.
3. Press the shaft (L=52AD11) into the switch. Connect the wires to the terminals.
4. Fix the VKA-switch to the OKA plate.

**Dimensions** (to convert to inches multiply by 0.03937)