MULTI-FUNCTION MODULE FILTERS



Primary Power Components Division

[EMI Filter Cross Reference](#)

[EMI Filter Inquiry Form](#)

RoHS
Compliant

Part Number		Electrical Schematic	Amp Rating	Size L x W x H	IEC Conn	Fuse Holder	Power Switch	Voltage Selector
864-03/001		A	3	3.61 x 1.99 x 2.37	Yes	Double*	D P	Yes
864-03/003		B	3	3.61 x 1.99 x 2.37	Yes	Single*	D P	Yes
864-06/005		A	6	3.61 x 1.99 x 2.37	Yes	Double*	D P	Yes
864-06/007		B	6	3.61 x 1.99 x 2.37	Yes	Single*	D P	Yes
864-10/009		A	10-6**	3.61 x 1.99 x 2.37	Yes	Double*	D P	Yes
864-10/011		B	10-6**	3.61 x 1.99 x 2.37	Yes	Single*	D P	Yes

* UL Rated 10A 125 and 250. VAC, CSA, VDE Rated 6A 250 VAC

** UL 10A 125/250 VAC, CSA 6A 125/250 VAC, VDE 6A 250VAC

880 Series Multi-Function Module Filters

A multi-function power entry module filter that incorporates an IEC connector, double pole power switch, voltage selector switch, and optional single or double fuse holder (5 x 20) offering space savings.

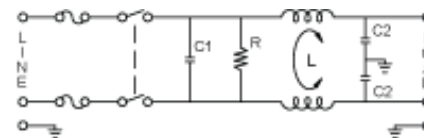

A

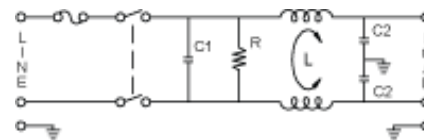

B

Part Number		Electrical Schematic	Amp Rating	Size L x W x H	IEC Conn	Fuse Holder	Power Switch	Voltage Selector
880-01/001		A	1	2.46 x 1.97 x 2.34	Yes	Double	D P*	No
880-01/004		B	1	2.46 x 1.97 x 2.34	Yes	Single	D P*	No

880-03/002		A	3	2.46 x 1.97 x 2.34	Yes	Double	D P*	No
880-03/005		B	3	2.46 x 1.97 x 2.34	Yes	Single	D P*	No
880-06/003		A	6	2.46 x 1.97 x 2.34	Yes	Double	D P*	No
880-06/006		B	6	2.46 x 1.97 x 2.34	Yes	Single	D P*	No

882 Series Multi-Function Module Filters

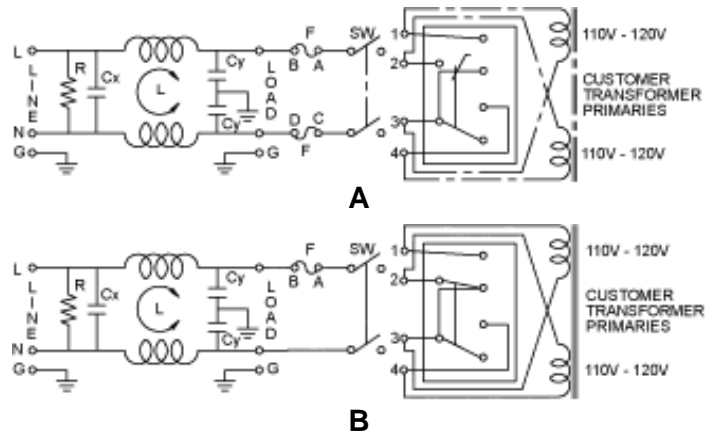

Part Number		Electrical Schematic	Amp Rating	Size L x W x H	IEC Conn	Fuse Holder	Power Switch	Voltage Selector
882-03/001		A	3	2.17 x 1.12 x 2.13	Y	DUAL	DP	Y
882-03/003		B	3	2.17 x 1.12 x 2.13	Y	SINGLE	DP	Y
882-06/011		A	6	2.17 x 1.12 x 2.13	Y	DUAL	DP	Y
882-06/013		B	6	2.17 x 1.12 x 2.13	Y	SINGLE	DP	Y
882-10/016		A	10	2.17 x 1.12 x 2.13	Y	DUAL	DP	Y
882-10/018		B	10	2.17 x 1.12 x 2.13	Y	SINGLE	DP	Y

THESE DRAWINGS ARE THE PROPERTY OF QUALTEK ELECTRONICS AND NOT TO BE REPRODUCED FOR OR COMMUNICATED TO A THIRD PARTY WITHOUT THE EXPRESS WRITTEN PERMISSION OF AN OFFICER OF QUALTEK ELECTRONICS.

REVISION			
REV.	DESCRIPTION		APPROVED
B	RoHS Compliancy		DP

1. PHYSICAL DIMENSIONS

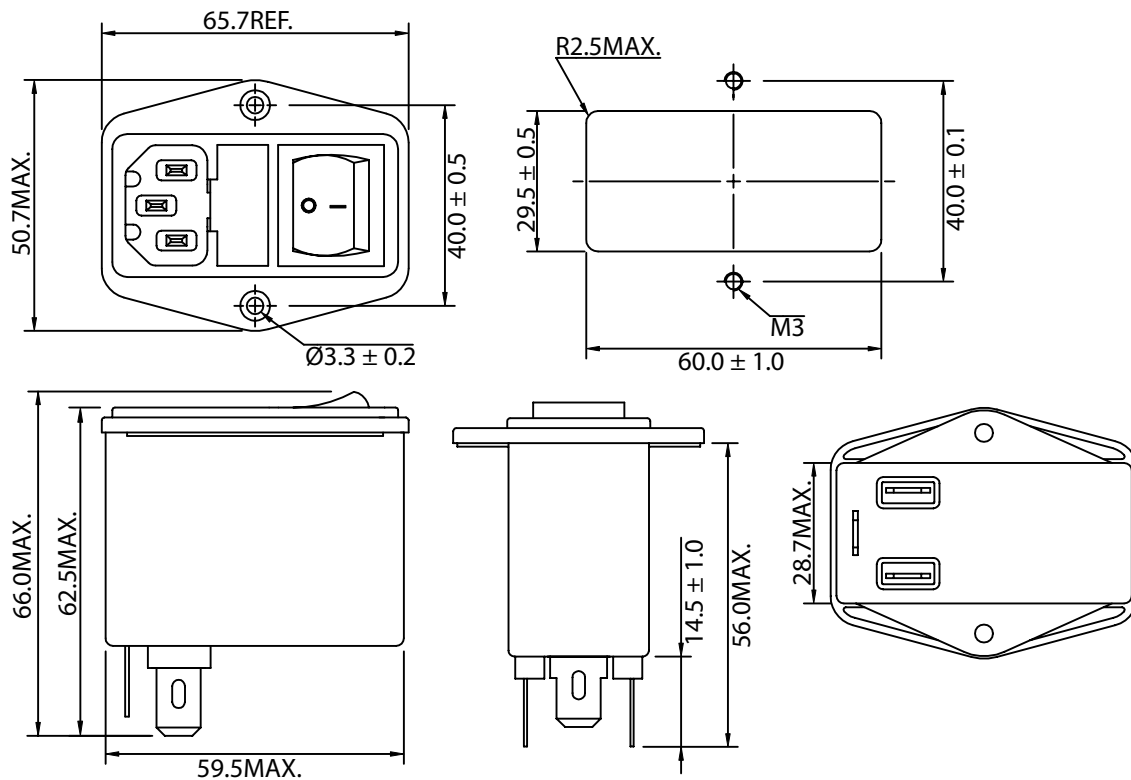

ELECTRICAL CHARACTERISTICS:

- 1-1. VOLTAGE RATING.....115/250VAC
- 1-2. CURRENT RATING
 A. @ 115 VAC.....3 A RMS MAX
 B. @ 250 VAC.....3 A RMS MAX
- 1-3. OPERATING FREQUENCY.....50/60Hz
- 1-4. LEAKAGE CURRENT: EACH LINE TO GROUND
 A. @ 115 VAC 60Hz.....0.20 mA MAX
 B. @ 250 VAC 50Hz.....0.40 mA MAX
- 1-5. HIPOT RATING (FOR ONE MINUTE)
 A. LINE TO GROUND.....2250 VDC
 B. LINE TO LINE.....1450 VDC
- 1-6. MINIMUM INSERTION LOSS IN dB: (AT 50 OHM SYSTEM)

FREQ. MHz	.01	.05	.10	.15	.50	1.0	5.0	10	30
COM. MODE dB	2	10	12	15	30	35	35	40	25
DIF. MODE dB	/	2	5	8	15	20	30	35	35

- 1-7. OPERATING TEMPERATURE.....-25° TO +85° C
- 1-8. SAFETY:
- 1-9. USE 5X20mm FUSE
- 1-10. RoHS COMPLIANT

CONTROLLED

2. ELECTRICAL SCHEMATIC

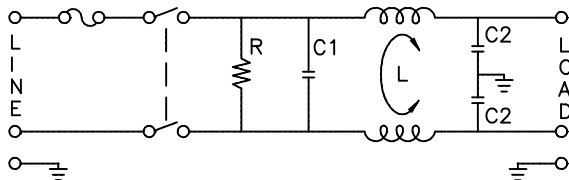

L: 2.0mH
 C1: 0.22uF
 C2: 2200pF
 R: 1.0MΩ

Dim range (mm)	Tolerance +/- (mm)	Qualtek Electronics Corp. PPC DIVISION	
		Part Number: 880-03/005	
0-1	0.15	Description: EMI FILTER	
1-6	0.20		
6-18	0.30		
18-50	0.50	UNIT: mm	
50-120	0.70	Drawn / Date	
120-250	0.90	B.ZHANG	
250-500	1.20		