

# SKD 110



**SEMIPONT® 4**

## Power Bridge Rectifiers

### SKD 110

#### Features

- Robust plastic case with screw terminals
- Large, isolated base plate
- Blocking voltage up to 1800 V
- High surge currents
- Three phase bridge rectifier
- Easy chassis mounting
- UL recognized, file no. E 63 532

#### Typical Applications

- Three phase rectifiers for power supplies
- Input rectifiers for variable frequency drives
- Rectifiers for DC motor field supplies
- Battery charger rectifiers

1) Available in limited quantities

2) Mounted on a painted metal sheet of min. 250 x 250 x 1 mm;

$R_{th(c-a)} = 1,8 \text{ K/W}$

$V_{RSM}$ V	$V_{RRM}, V_{DRM}$ V	$I_D = 110 \text{ A (full conduction)}$ ( $T_c = 100 \text{ °C}$ )
800	800	SKD 110/08
1200	1200	SKD 110/12
1400	1400	SKD 110/14
1600	1600	SKD 110/16
1800	1800	SKD 110/18 <sup>1)</sup>

Symbol	Conditions	Values	Units
$I_D$	$T_c = 85 \text{ °C}$	151	A
	$T_a = 45 \text{ °C; chassis } ^2)$	28	A
	$T_a = 45 \text{ °C; P1/200}$	70	A
	$T_a = 35 \text{ °C; P1/120 F}$	110	A
	$T_a = 35 \text{ °C; P3/120 F}$	123	A
$I_{FSM}$	$T_{vj} = 25 \text{ °C; 10 ms}$	1200	A
	$T_{vj} = 150 \text{ °C; 10 ms}$	1000	A
$i^2t$	$T_{vj} = 25 \text{ °C; 8,3 ... 10 ms}$	7200	A <sup>2</sup> s
	$T_{vj} = 150 \text{ °C; 8,3 ... 10 ms}$	5000	A <sup>2</sup> s
$V_F$	$T_{vj} = 25 \text{ °C; } I_F = 300 \text{ A}$	max. 1,9	V
$V_{(TO)}$	$T_{vj} = 150 \text{ °C}$	max. 0,85	V
$r_T$	$T_{vj} = 150 \text{ °C}$	max. 4	mΩ
$I_{RD}$	$T_{vj} = 25 \text{ °C; } V_{DD} = V_{DRM}; V_{RD} = V_{RRM}$	max. 0,5	mA
	$T_{vj} = 150 \text{ °C; } V_{RD} = V_{RRM}$	5	mA
$R_{th(j-c)}$	per diode	0,9	K/W
	total	0,15	K/W
$R_{th(c-s)}$	total	0,03	K/W
$T_{vj}$		- 40 ... + 150	°C
$T_{stg}$		- 40 ... + 125	°C
$V_{isol}$	a. c. 50 Hz; r.m.s.; 1 s / 1 min.	3600 ( 3000 )	V
$M_s$	to heatsink	$5 \pm 15 \%$	Nm
$M_t$	to terminals	$5 \pm 15 \%$	Nm
$m$		270	g
Case		G 37	

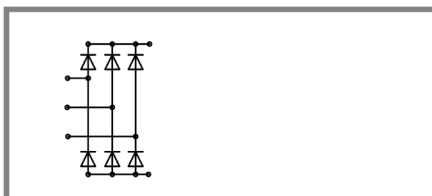

**SKD**

Dimensions in mm

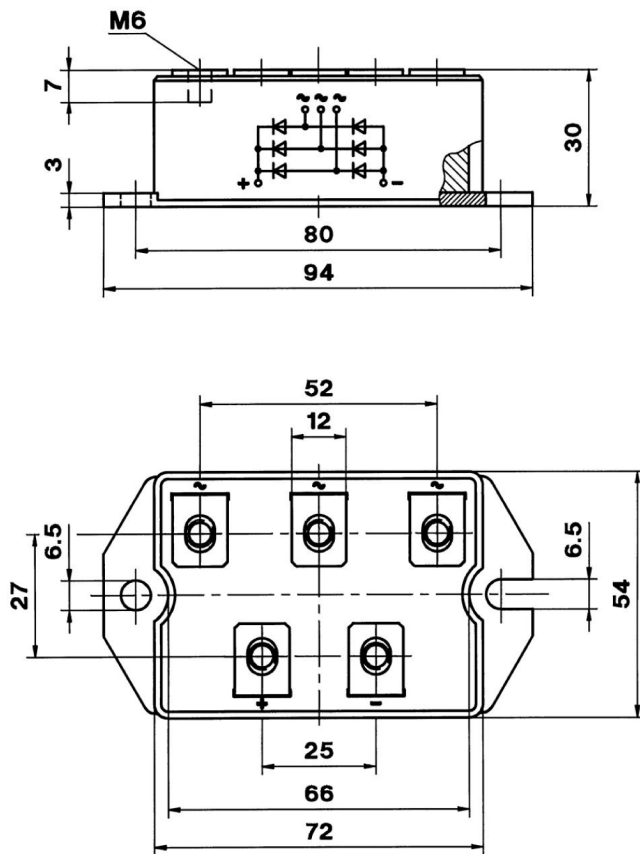

Case G 37

This technical information specifies semiconductor devices but promises no characteristics. No warranty or guarantee expressed or implied is made regarding delivery, performance or suitability.