

Electronic timer CT-EBD.12

Flasher starting with ON with 1 c/o contact

Data sheet

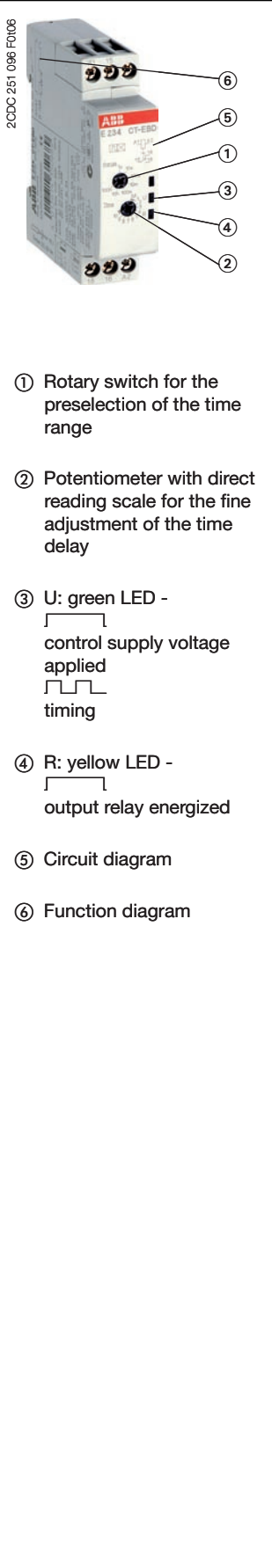

Features

- Rated control supply voltage 24-48 V DC, 24-240 V AC
- Single-function timer flasher, starting with ON
- 7 time ranges (0.05 s - 100 h) in one device
- 1 c/o contact (250 V / 6 A)
- 2 LEDs for status indication
- Width of only 17.5 mm
- Light-grey enclosure in RAL 7035

Approvals

- UL 508, CAN/CSA C22.2 No.14
- GOST
- CB scheme
- CCC

Marks

- CE CE
- C-Tick C-Tick

Order data

Type	Rated control supply voltage	Time range	Output	Order code
CT-EBD.12	24-48 V DC, 24-240 V AC	0.05 s - 100 h	1 c/o contact	1SVR 500 150 R0000

Application

With their structural form and their width of 17.5 mm only, the CT-D range timers are ideally suited for installation in distribution cabinets.

Operating mode

The CT-EBD.12 has 1 c/o contact and offers 7 time ranges, from 0.05 s to 100 h. The time delay range is rotary switch selectable on the front of the unit. The fine adjustment of the time delay is made via an internal potentiometer, with a direct reading scale, on the front of the unit.

Function diagram(s)

Flasher, starting with ON

Applying control supply voltage starts timing with symmetrical ON & OFF times. The cycle starts with an ON time first. The ON & OFF times are displayed by the flashing green LED, which flashes twice as fast during the OFF time.

If control supply voltage is interrupted, the output relay de-energizes and the time delay is reset.

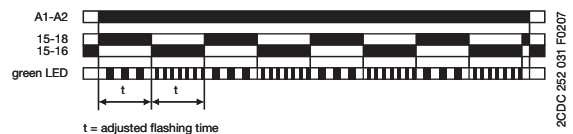

Electronic timer CT-EBD.12

Flasher starting with ON with 1 c/o contact

Data sheet

Connection diagram(s)

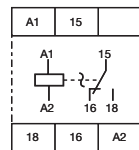

2CDC 252 180 F0005

15-16/18
A1-A2

1. c/o contact
Rated control supply voltage U_s
24-48 V DC or 24-240 V AC



Electronic timer CT-EBD.12

Flasher starting with ON with 1 c/o contact

Data sheet

Technical data

Data at $T_a = 25\text{ °C}$ and rated values, if nothing else indicated

Input circuits - Supply circuit		1SVR 500 150 R0000		
Rated control supply voltage U_s	A1-A2	24-240 V AC		
	A1-A2	24-48 V DC		
Rated control supply voltage tolerance	24-240 V AC	-15...+10 %		
	24-48 V DC	-15...+10 %		
Typical current / power consumption		24 V DC	230 V AC	115 V AC
	24-48 V DC	12.90 mA / -	- / -	- / -
	24-240 V AC	- / -	58.60 mA / -	48.03 mA / -
Rated frequency	DC; 50/60 Hz			
Frequency range AC	47-63 Hz			
Power failure buffering time	min. 20 ms			
Timing circuit		1SVR 500 150 R0000		
Kind of timer	Single-function timer	Flasher, starting with ON		
Time ranges 0.05 s - 100 h	0.05-1 s, 0.5-10 s, 5-100 s, 0.5-10 min, 5-100 min, 0.5-10 h, 5-100 h			
Recovery time	< 50 ms			
Accuracy within the rated control supply voltage tolerance	$\Delta t < 0.005\ %/V$			
Accuracy within the temperature range	$\Delta t < 0.06\ %/^{\circ}C$			
Indication of operational states		1SVR 500 150 R0000		
Control supply voltage / timing	U: green LED	 : control supply voltage applied		
Control supply voltage / timing	U: green LED	 : timing		
Relay status	R: yellow LED	 : output relay energized		
Output circuits		1SVR 500 150 R0000		
Kind of output	15-16/18	Relay, 1. c/o contact		
Contact material	Cd-free			
Rated operational voltage U_e	250 V			
Minimum switching voltage / Minimum switching current	12 V / 100 mA			
Maximum switching voltage / Minimum switching current	see load limit curve / see load limit curve			
Rated operational current I_e (IEC 60947-5-1)	AC12 (resistive) at 230 V	6 A		
	AC15 (inductive) at 230 V	3 A		
	DC12 (resistive) at 24 V	6 A		
	DC13 (inductive) at 24 V	2 A		
Mechanical lifetime	30 x 10 ⁶ switching cycles			
Electrical lifetime	0.1 x 10 ⁶ switching cycles (AC12, 230 V, 4 A)			
Short-circuit resistance, maximum fuse rating (IEC/EN 60947-5-1)	n/c contact	6 A fast-acting		
	n/o contact	10 A fast-acting		
General data		1SVR 500 150 R0000		
Duty time	100 %			
Repeat accuracy (constant parameters)	$\Delta t \leq \pm 0.5\ %$			

Electronic timer CT-EBD.12

Flasher starting with ON with 1 c/o contact

Data sheet

General data		1SVR 500 150 R0000
Dimensions (W x H x D)		17.5 x 70 x 58 mm (0.69 x 2.76 x 2.28 inches)
Weight		approx. 60 g (approx. 0.13 lb)
Mounting position		any
Minimum distance to other units		
normal operation mode	horizontal	none
	vertical	none
Mounting		DIN rail (EN 60715), snap-on mounting without any tool
Degree of protection enclosure / terminals		IP50 / IP20
Electrical connection		1SVR 500 150 R0000
all circuits		Screw connection
Wire size	fine-strand with wire end ferrule	2 x 0.5-1.5 mm ² / 1 x 0.5-2.5 mm ² (2 x 20-16 AWG) / (1 x 20-14 AWG)
	fine-strand without wire end ferrule	2 x 0.5-1.5 mm ² / 1 x 0.5-2.5 mm ² (2 x 20-16 AWG) / (1 x 20-14 AWG)
	rigid	2 x 0.5-1.5 mm ² / 1 x 0.5-4 mm ² (2 x 20-16 AWG) / (1 x 20-12 AWG)
Stripping length		7 mm (0.28 inches)
Tightening torque		0.5-0.8 Nm
Environmental data		1SVR 500 150 R0000
Ambient temperature range	operation	-20...+60 °C
	storage	-40...+85 °C
Damp heat, cyclic (IEC/EN 60068-2-30)		6 x 24 h cycles, 55 °C, 95 % RH
Vibration, sinusoidal (IEC/EN 60068-2-6)		4 m/s ² , 20 cycles, 10...150...10 Hz
Shock, half-sine (IEC/EN 60068-2-27)		100 m/s ² , 11 ms
Isolation data		1SVR 500 150 R0000
Rated isolation voltage U _i	Output circuit 1 / Output circuit 2	300 V
	Input circuit / Output circuit	300 V
Rated impulse withstand voltage U _{imp} (type test) (IEC/EN 60664-1, VDE 0110)	between all isolated circuits	4 kV; 1.2/50 µs
Power-frequency withstand voltage test (Test voltage, routine test)	between all isolated circuits	2.5 kV, 50 Hz, 1 s
Basic insulation (IEC/EN 61140)	Input circuit / Output circuit	300 V
Protective separation (IEC/EN 61140, VDE 0106 part 101 and part 101/A1)	Input circuit / Output circuit	250 V
Pollution degree (IEC/EN 60664-1, VDE 0110, UL 508)		3
Overvoltage category (IEC/EN 60664-1, VDE 0110, UL 508)		III
Standards / Directives		1SVR 500 150 R0000
Product standard		IEC 61812-1, EN 61812-1 + A11, DIN VDE 0435 part 2021
EMC Directive		2004/108/EC
Low Voltage Directive		2006/95/EC
RoHS Directive		2002/95/EC

Electronic timer CT-EBD.12

Flasher starting with ON with 1 c/o contact

Data sheet

Electromagnetic compatibility		1SVR 500 150 R0000
Interference immunity		IEC/EN 61000-6-1 IEC/EN 61000-6-2
electrostatic discharge (ESD)	IEC/EN 61000-4-2	Level 3 (6 kV / 8 kV)
electromagnetic field (HF radiation resistance)	IEC/EN 61000-4-3	Level 3 (10 V/m)
fast transients (Burst)	IEC/EN 61000-4-4	Level 3 (2 kV / 5 kHz)
powerful impulses (Surge)	IEC/EN 61000-4-5	Level 4 (2 kV L-L)
HF line emission	IEC/EN 61000-4-6	Level 3 (10 V)
Interference emission		IEC/EN 61000-6-3 IEC/EN 61000-6-4
electromagnetic field (HF radiation resistance)	IEC/CISPR 22, EN 55022	Class B
HF line emission	IEC/CISPR 22, EN 55022	Class B

Electronic timer CT-EBD.12

Flasher starting with ON with 1 c/o contact

Data sheet

Technical diagrams

Load limit curve

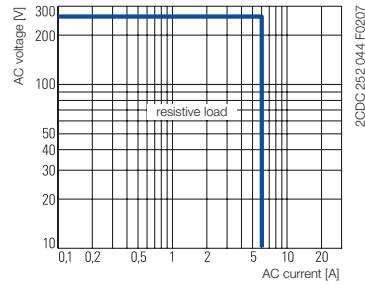

AC load (resistive)

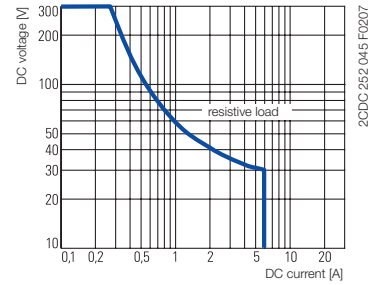

DC load (resistive)

Derating factor F

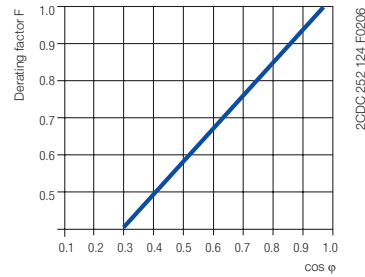

for inductive AC load

Contact lifetime

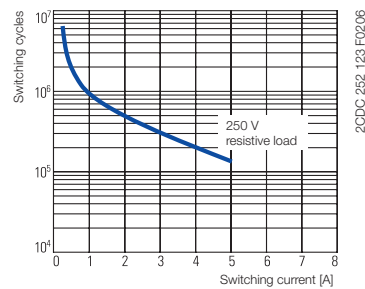

Electronic timer CT-EBD.12

Flasher starting with ON with 1 c/o contact

Data sheet

Dimensions

in mm

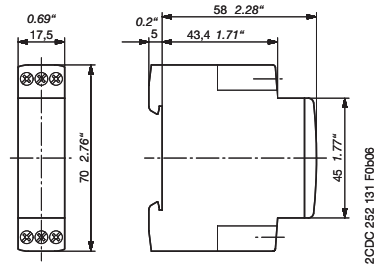

CT-EBD.12

Synonyms

Used expression	Alternative expression(s)
1 c/o contact	1 SPDT

Further Documentation

Document title	Document type	Document number
Electronic Products and Relays	Technical catalogue	2CDC 110 004 C020x

You can find the documentation in the internet under www.abb.com/lowvoltage → Control Products → ...



As part of the on-going product improvement, ABB reserves the right to modify the characteristics of the products described in this document. The information given is non-contractual.

For further details please contact (www.abb.com/contacts) the ABB company marketing these products in your country.

Document number: 2CDC 111 055 D0201 (12/2007)

ABB STOTZ-KONTAKT GmbH

Eppelheimer Strasse 82, 69123 Heidelberg, Germany
Postfach 10 16 80, 69006 Heidelberg, Germany
Internet <http://www.abb.com/lowvoltage> → Control Products