

Electronic timer CT-ERD.22

ON-delayed with 2 c/o contacts

Data sheet

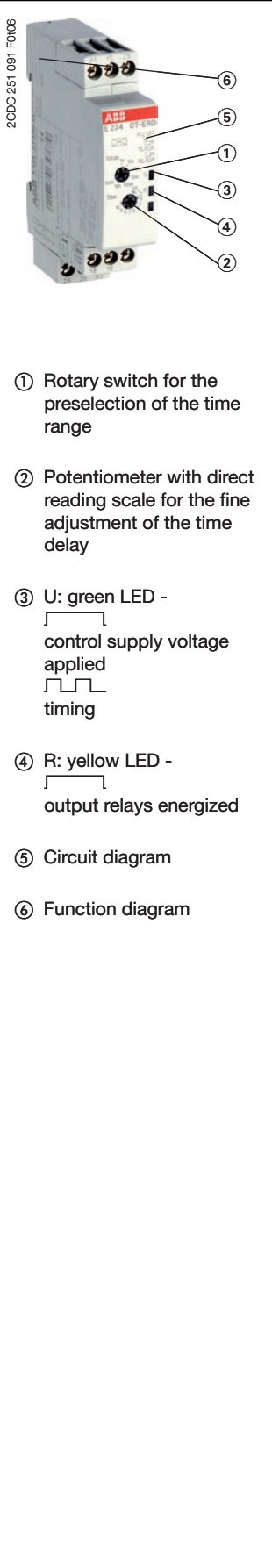

Features

- Rated control supply voltage 24-48 V DC, 24-240 V AC
- Single-function timer ON-delay
- 7 time ranges (0.05 s - 100 h) in one device
- 2 c/o contacts (250 V / 5 A)
- 2 LEDs for status indication
- Width of only 17.5 mm
- Light-grey enclosure in RAL 7035

Approvals

	UL 508, CAN/CSA C22.2 No.14	
	GOST	
	CB scheme	pending
	CCC	pending

Marks

	CE	
	C-Tick	pending

Order data

Type	Rated control supply voltage	Time range	Output	Order code
CT-ERD.22	24-48 V DC, 24-240 V AC	0.05 s - 100 h	2 c/o contacts	1SVR 500 100 R0100

Application

With their structural form and their width of 17.5 mm only, the CT-D range timers are ideally suited for installation in distribution cabinets.

Operating mode

The CT-ERD.22 has 2 c/o contacts and offers 7 time ranges, from 0.05 s to 100 h. The time delay range is rotary switch selectable on the front of the unit. The fine adjustment of the time delay is made via an internal potentiometer, with a direct reading scale, on the front of the unit.

Function diagram(s)

☒ ON-delay

This function requires continuous control supply voltage for timing. Timing begins when control supply voltage is applied. The green LED flashes during timing. When the selected time delay is complete, the output relay energizes and the flashing green LED turns steady. If control supply voltage is interrupted, the output relay de-energizes and the time delay is reset.

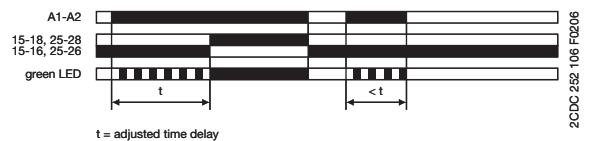

Electronic timer CT-ERD.22

ON-delayed with 2 c/o contacts

Data sheet

Connection diagram(s)

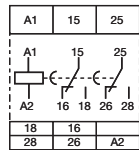

2CDC252-1/5 F0006

15-16/18
25-26/28
A1-A2

1. c/o contact
2. c/o contact
Rated control supply voltage U_s
24-48 V DC or 24-240 V AC



Electronic timer CT-ERD.22

ON-delayed with 2 c/o contacts

Data sheet

Technical data

Data at $T_a = 25\text{ °C}$ and rated values, if nothing else indicated

Input circuits - Supply circuit		1SVR 500 100 R0100		
Rated control supply voltage U_s	A1-A2	24-240 V AC		
	A1-A2	24-48 V DC		
Rated control supply voltage tolerance	24-240 V AC	-15...+10 %		
	24-48 V DC	-15...+10 %		
Typical current / power consumption		24 V DC	230 V AC	115 V AC
	24-48 V DC	22.62 mA / -	- / -	- / -
	24-240 V AC	- / -	27.40 mA / -	17.50 mA / -
Rated frequency	DC; 50/60 Hz			
Frequency range AC	47-63 Hz			
Power failure buffering time	min. 30 ms			
Timing circuit		1SVR 500 100 R0100		
Kind of timer	Single-function timer	ON-delay		
Time ranges 0.05 s - 100 h	0.05-1 s, 0.5-10 s, 5-100 s, 0.5-10 min, 5-100 min, 0.5-10 h, 5-100 h			
Recovery time	< 50 ms			
Accuracy within the rated control supply voltage tolerance	$\Delta t < 0.005\ %/V$			
Accuracy within the temperature range	$\Delta t < 0.06\ %/^{\circ}C$			
Indication of operational states		1SVR 500 100 R0100		
Control supply voltage / timing	U: green LED	 : control supply voltage applied		
Control supply voltage / timing	U: green LED	 : timing		
Relay status	R: yellow LED	 : output relay energized		
Output circuits		1SVR 500 100 R0100		
Kind of output	15-16/18	Relay, 1. c/o contact		
	25-26/28	Relay, 2. c/o contact		
Contact material	Cd-free			
Rated operational voltage U_e	250 V			
Derating				
Minimum switching voltage / Minimum switching current	12 V / 100 mA			
Maximum switching voltage / Minimum switching current	see load limit curve / see load limit curve			
Rated operational current I_e (IEC 60947-5-1)	AC12 (resistive) at 230 V	5 A		
	AC15 (inductive) at 230 V	3 A		
	DC12 (resistive) at 24 V	5 A		
	DC13 (inductive) at 24 V	2 A		
Mechanical lifetime	30 x 10 ⁶ switching cycles			
Electrical lifetime	0.1 x 10 ⁶ switching cycles (AC12, 230 V, 4 A)			
Short-circuit resistance, maximum fuse rating (IEC/EN 60947-5-1)	n/c contact	6 A fast-acting		
	n/o contact	10 A fast-acting		

Electronic timer CT-ERD.22

ON-delayed with 2 c/o contacts

Data sheet

General data		1SVR 500 100 R0100
Duty time		100 %
Repeat accuracy (constant parameters)		$\Delta t < \pm 0.5 \%$
Dimensions (W x H x D)		17.5 x 80 x 58 mm (0.69 x 3.15 x 2.28 inches)
Weight		approx. 65 g (approx. 0.14 lb)
Mounting position		any
Minimum distance to other units		
normal operation mode	horizontal	none
	vertical	none
Mounting		DIN rail (EN 60715), snap-on mounting without any tool
Degree of protection enclosure / terminals		IP50 / IP20
Electrical connection		1SVR 500 100 R0100
all circuits		Screw connection
Wire size	fine-strand with wire end ferrule	2 x 0.5-1.5 mm ² / 1 x 0.5-2.5 mm ² (2 x 20-16 AWG) / (1 x 20-14 AWG)
	fine-strand without wire end ferrule	2 x 0.5-1.5 mm ² / 1 x 0.5-2.5 mm ² (2 x 20-16 AWG) / (1 x 20-14 AWG)
	rigid	2 x 0.5-1.5 mm ² / 1 x 0.5-4 mm ² (2 x 20-16 AWG) / (1 x 20-12 AWG)
Stripping length		7 mm (0.28 inches)
Tightening torque		0.5-0.8 Nm
Environmental data		1SVR 500 100 R0100
Ambient temperature range	operation	-20...+60 °C
	storage	-40...+85 °C
Damp heat, cyclic (IEC/EN 60068-2-30)		6 x 24 h cycles, 55 °C, 95 % RH
Vibration, sinusoidal (IEC/EN 60068-2-6)		4 m/s ² , 20 cycles, 10...150...10 Hz
Shock, half-sine (IEC/EN 60068-2-27)		100 m/s ² , 11 ms
Isolation data		1SVR 500 100 R0100
Rated isolation voltage U _i	Output circuit 1 / Output circuit 2	300 V
	Input circuit / Output circuit	300 V
Rated impulse withstand voltage U _{imp} (type test) (IEC/EN 60664-1, VDE 0110)	between all isolated circuits	4 kV; 1.2/50 μs
Power-frequency withstand voltage test (Test voltage, routine test)	between all isolated circuits	2.5 kV, 50 Hz, 1 s
Basic insulation (IEC/EN 61140)	Input circuit / Output circuit	300 V
Protective separation (IEC/EN 61140, VDE 0106 part 101 and part 101/A1)	Input circuit / Output circuit	250 V
Pollution degree (IEC/EN 60664-1, VDE 0110, UL 508)		3
Overvoltage category (IEC/EN 60664-1, VDE 0110, UL 508)		III
Standards / Directives		1SVR 500 100 R0100
Product standard		IEC 61812-1, EN 61812-1 + A11, DIN VDE 0435 part 2021
EMC Directive		2004/108/EC

Electronic timer CT-ERD.22

ON-delayed with 2 c/o contacts

Data sheet

Standards / Directives		1SVR 500 100 R0100
Low Voltage Directive		2006/95/EC
RoHS Directive		2002/95/EC
Electromagnetic compatibility		1SVR 500 100 R0100
Interference immunity		IEC/EN 61000-6-1 IEC/EN 61000-6-2
electrostatic discharge (ESD)	IEC/EN 61000-4-2	Level 3 (6 kV / 8 kV)
electromagnetic field (HF radiation resistance)	IEC/EN 61000-4-3	Level 3 (10 V/m)
fast transients (Burst)	IEC/EN 61000-4-4	Level 3 (2 kV / 5 kHz)
powerful impulses (Surge)	IEC/EN 61000-4-5	Level 4 (2 kV L-L)
HF line emission	IEC/EN 61000-4-6	Level 3 (10 V)
Interference emission		IEC/EN 61000-6-3 IEC/EN 61000-6-4
electromagnetic field (HF radiation resistance)	IEC/CISPR 22, EN 55022	Class B
HF line emission	IEC/CISPR 22, EN 55022	Class B

Electronic timer CT-ERD.22

ON-delayed with 2 c/o contacts

Data sheet

Technical diagrams

Load limit curve

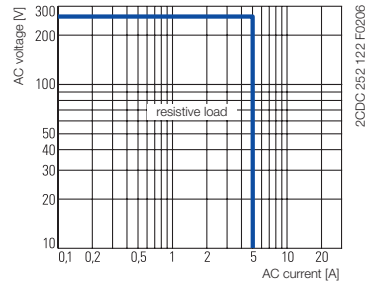

AC load (resistive)

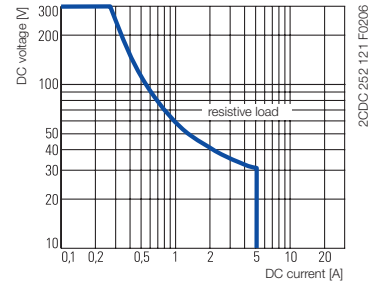

DC load (resistive)

Derating factor F

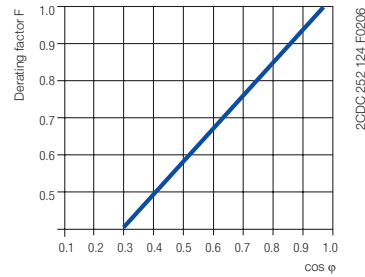

for inductive AC load

Contact lifetime

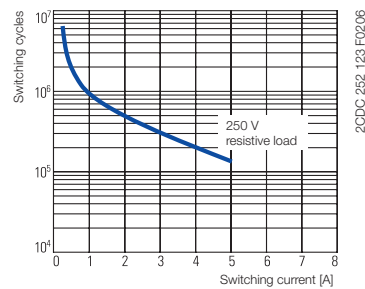

Electronic timer CT-ERD.22

ON-delayed with 2 c/o contacts

Data sheet

Dimensions

in mm

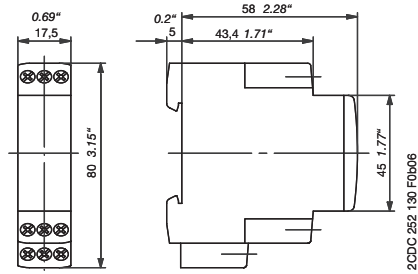

CT-ERD.22

Synonyms

Used expression	Alternative expression(s)
2 c/o contacts	1 DPDT / 2 SPDT

Further Documentation

Document title	Document type	Document number
Electronic Products and Relays	Technical catalogue	2CDC 110 004 C020x

You can find the documentation in the internet under www.abb.com/lowvoltage → Control Products → ...



As part of the on-going product improvement, ABB reserves the right to modify the characteristics of the products described in this document. The information given is non-contractual.

For further details please contact (www.abb.com/contacts) the ABB company marketing these products in your country.

Document number: 2CDC 111 057 D0201 (12/2007)

ABB STOTZ-KONTAKT GmbH

Eppelheimer Strasse 82, 69123 Heidelberg, Germany
Postfach 10 16 80, 69006 Heidelberg, Germany
Internet <http://www.abb.com/lowvoltage> → Control Products