

## Fuse & Switch

### Product Facts

#### High Density Blocks

- n Fuse and Switch Blocks rated 15A and 300V.
- n High Density 0.36" [9.14] centerline spacing saves panel space; at least 33 circuits per foot.

#### Fuse Blocks

- n Provide in-line circuit protection for virtually any circuit or group of circuits — select contacts for terminated or unterminated wire.
- n Remove, check and replace fuses safely and quickly — switch action fuse blocks open circuits before fuse can be removed or installed.
- n Contacts conservatively rated to 30 amperes.

#### Switch Blocks

- n Quickly and easily interrupt a circuit or group of circuits — insert switch blocks directly in line. Contacts available for terminated or unterminated wire.
- n Keep circuits open for extended periods — switch blade can be removed entirely from block for lock-out protection.
- n Rated to 15 amperes.

#### Common Features of 300 & 0300 Series

- n At least 91 circuits per 6-foot length, 3/4 inch center-to-center spacing.
- n Blocks meet 600 volt clearance and creepage spacings specified in UL, CSA, and NEMA Industrial Control Standards.
- n Choose nylon housing material — for more rugged applications; polypropylene for fire retardant characteristics.
- n Dovetail base fits standard mounting channel — can also be mounted on flat surfaces.
- n Only one end section needed per block assembly.

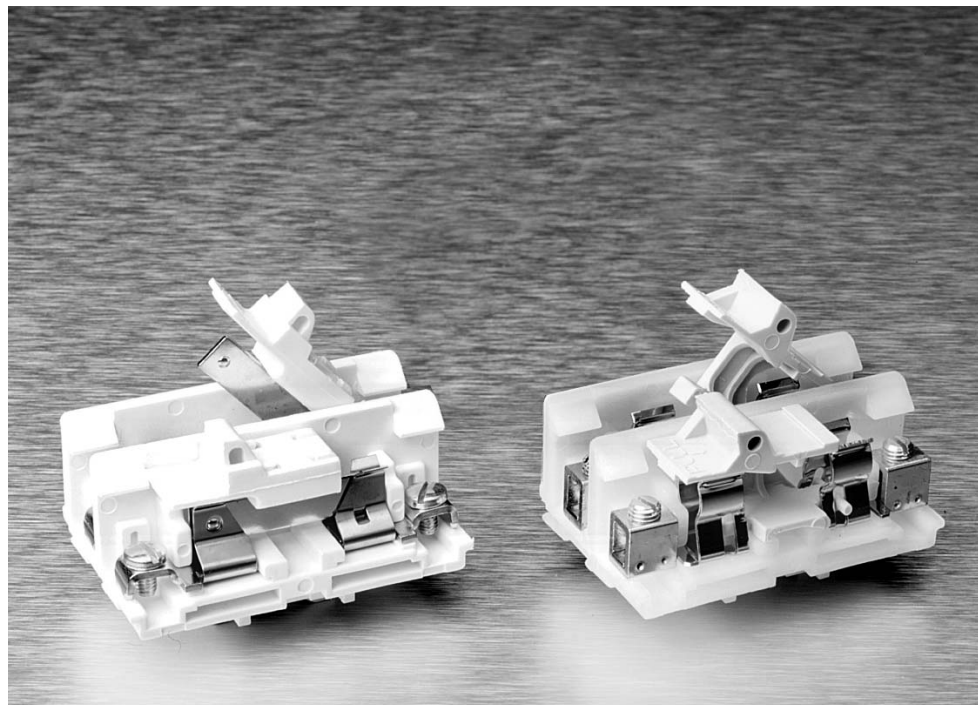

- n Readily identify circuits — mark directly on white, matte-surface puller assembly, marking tab on block, or use removable marking tape.
- n Open or close several circuits simultaneously — holes in puller handles allow use of nylon “ganging” rods.
- n Fuse and Switch block sections snap-fit with 300 & 600 Volt, phenolic Medium Duty, Heavy Duty, and Intermediate Heavy Duty blocks.

This broad line features High Density Blocks (Series 0135), Nylon & Polypropylene Blocks (Series 0300) and Phenolic Blocks (Series 300).

**Note:** All part numbers are RoHS Compliant.

## 0300 Series, Fuse & Switch, Nylon and Polypropylene

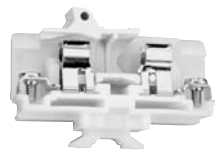

**Fuse Block  
Strap Screw**

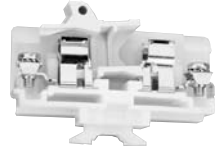

**Fuse Block  
Strap Clamp**

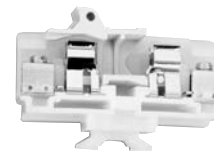

**Fuse Block  
Tubular Screw**

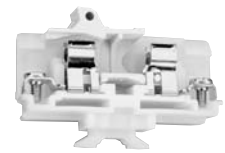

**Switch Block  
Strap Screw**

**Characteristics**

Type of Block	Model	Part Number	Model	Part Number	Model	Part Number	Model	Part Number
<b>Channel Mount (Dovetail Base)</b>								
Nylon	0311	1437397-1	0318	1437397-3	0312	1437397-2	0371	1-1437397-7
Polypropylene	P0311	4-1437397-0	P0318	4-1437397-3	P0312	4-1437397-2	P0371	4-1437397-4
Corrosion Resistant Nylon	D0311	1-1437389-1	D0318	1776726-1	D0312	1-1437389-2	D0371	1-1437389-7
Corrosion Resistant Polypropylene	DP0311	6-1437389-2	DP0318	1776727-1	DP0312	6-1437389-3	DP0371	1776728-1

**Contact Type**



**Specifications**

Wire Range (AWG) Solid & Stranded	22-8	18-8	18-8	22-8
Wire Strip Length (in.)	—	1/2	1/2	—
Screw Type	10-32 binding head	8-32 pan head w/clamp	1/4"-28 set screw	10-32 binding head

**Ampacity**

25 A	25 A	25 A	15 A
------	------	------	------

**End Sections**

Channel Mount, Nylon	0380	2-1437397-0	0380	2-1437397-0	0380	2-1437397-0	0380	2-1437397-0
Channel Mount, Polypropylene	P0380	4-1437397-7	P0380	4-1437397-7	P0380	4-1437397-7	P0380	4-1437397-7

**Notes:** Standard package is 100 pieces for contact, 25 pieces for end section.

For factory assembled blocks on channel, suffix Catalog Number with number of blocks desired. Without channel delete "0" prefix on Catalog Number.

EXAMPLE:

Ten strap-screw fuse block sections preassembled on channel = 031110.

For blocks with two or more contact types, preassembled with other blocks, imprinting or special features, consult Technical Support.

**0300 Series, Fuse & Switch, Nylon and Polypropylene (Continued)**

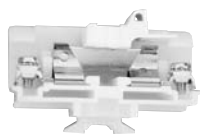

**Switch Block  
Strap Clamp**

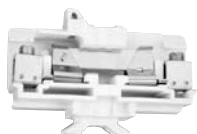

**Switch Block  
Tubular Screw**

Model	Part Number	Model	Part Number
0378	1-1437397-9	0372	1-1437397-8
P0378	4-1437397-6	P0372	4-1437397-5
D0378	1776729-1	D0372	1776731-1
DP0378	1776730-1	DP0372	1776732-1



18-8	18-8		
1/2	1/2		
8-32 pan head w/clamp	1/4"-28 set screw		
15 A	15 A		
0380	2-1437397-0	0380	2-1437397-0
P0380	4-1437397-7	P0380	4-1437397-7

**Fuse Puller:**

Material	High-temperature, glass-reinforced nylon
Color	Black

**Switch Handle:**

Material	Polypropylene
Color	White

**Specifications**

**Pitch**—0.75" [19.05] centerline, 16 circuits per foot

**Voltage Rating**—Blocks meet 600 volt creepage and clearance requirements of NEMA, UL and CSA for general industrial control equipment and panelboards. Withstand voltages greatly in excess of IEE switchgear standards for 750 volts.

**Fuse Size**—Any 13/32 x 1-1/2 in. [10.32 x 28.10] ferrule type cartridge fuse up to 25 amps, indicating or non-indicating, which meets Mil. Spec. F-15160.

**Standard Contacts**

**Material**—Electrical grade copper or copper alloy conductor. Steel Screws plated to resist corrosion in most industrial applications

**AL-CU Tubular Screw**—Aluminum compatibility with aluminum or copper conductors. AL-CU is tin-plated brass.

**Environmental Contacts  
(for highly corrosive atmospheres)**

**Tubular Screw**—Electrical grade copper tube with nickel plating. Nickel plated brass screws.

**Strap Screw**—Nickel plated brass straps and screws. Nickel plating meets specification QQ-N-290A Class I, Grade G.

**Polyamide Material:**

**Housing Material**—Polyamide, Unfilled Type 6/6

**Max. Continuous Temperature**—125°C, (257°F)

**Breakdown Voltage (AC, 60 Hz)**—

Contact-to-Contact: 7000V

Contact-to-Ground: 10,000V

**Dielectric Strength (RH 40% at Sea Level)**—470-385 Volts/mil thickness Per ASTM D149

**UL High Voltage Arc Tracking (inches/min.)**—0.1-.35 [.25-8.89]

**Water Absorption (24 hrs. % wt. gain)**—1.5% per ASTM D570

**Flammability**—UL94V-2

**Chemical Resistance**—Resistant to aromatic hydrocarbons, strong alkalies per ASTM D543

**Radiation Resistance (ergs g-1 (C))**—8 x 107

**Color**—Translucent White

**Polypropylene Material:**

**Housing Material**—Polypropylene, Filled self-extinguishing

**Max. Continuous Temperature**—105°C, (221°F)

**Breakdown Voltage (AC, 60Hz)**—

Contact-to-Ground: 10,000V

Contact-to-Contact: 7000V

**Dielectric Strength (RH 40% at Sea Level)**—500 Volts/mil thickness per ASTM D149

**UL High Voltage Arc Tracking (inches/min.)**—Did not track

**Water Absorption (24 hrs. % wt. gain)**—0.02% Per ASTM D570

**Flammability**—UL94V-0

**Chemical Resistance**—Resistant to most acids, alkalines, and saline solutions. Also resistant to higher aliphatic solvents and polar substances per ASTM D543

**Radiation Resistance (ergs g-1 (C))**—No data Available

**Color**—Opaque White

**Note:** All part numbers are RoHS Compliant.

**0300 Series, Fuse & Switch, Nylon and Polypropylene (Continued)**

**Mounting Channel**



Steel Channel	Break Away Steel	Pre-punched Aluminum Channel
<b>Part Number</b>		
9-1437381-1 9-1437381-8	9-1437381-2	9-1437381-9 1437382-2
<b>Catalog Number</b>		
60 63-BU	60-B-36	64 67
<b>Standard Length</b>		
6 feet 3 feet	3 feet	6 feet 3 feet

**Channel Clamps**



**Marking Accessories**



Screw Channel Clamps	Universal Clamps	Snap-In Clamps	Ganging Rod	Coated Cloth Marking tape
<b>Part Number</b>				
9-1437381-5	1437382-3	9-1437381-7	3-1437381-9	8-1437381-0
<b>Catalog Number</b>				
61	68	62	30	55-BU
<b>Standard Length</b>				
—	—	—	2 feet	50 feet

**Related Product Data**

**Wire Pins and Ferrules**—Pages 109-111  
For more information on AMP Standard Terminals and Splices or Quick-Connect FASTON Receptacles and Tabs, request Catalog 82042.

**Note:** All part numbers are RoHS Compliant.

**0300 Series, Fuse & Switch, Nylon and Polypropylene (Continued)**

**Dovetail Base Mounted On Standard #60 Channel. May Also Be Mounted Direct**

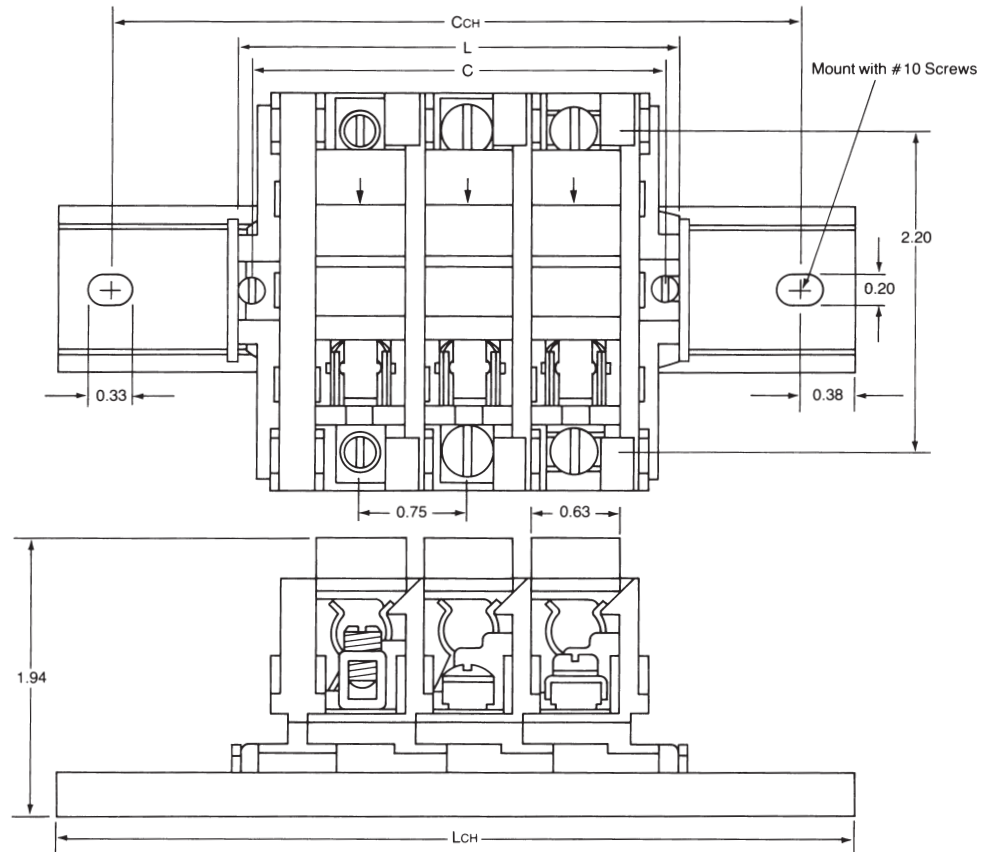

**CHANNEL MOUNTED**  
 $CCH = 2.28 + (.75 \times N)$   
 $LCH = 3.03 + (.75 \times N)$   
 N = Number of Circuits

**DIRECT MOUNTED**  
 $C = .56 + (.75 \times N)$   
 $L = .78 + (.75 \times N)$   
 N = Number of Circuits

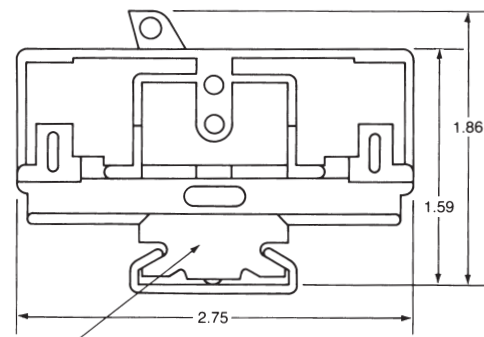

Standard Channel Clamp #61 Shown

**Note:** All part numbers are RoHS Compliant.

### 300 Series, Fuse & Switch, Phenolic

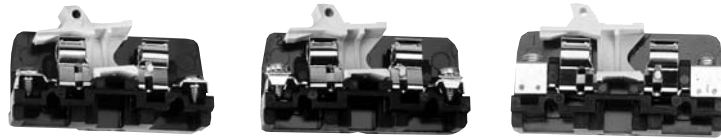

**Characteristics**

**Strap Screw**

**Strap Clamp**

**Tubular Screw**

Type of Block	Model	Part Number	Model	Part Number	Model	Part Number
<b>Direct Mount (Flat Base)</b>						
Fuse Block with Puller	351	2-1437397-8	358	3-1437397-1	352	3-1437397-0
Fuse Block without Puller	361	2-1437397-2	368-BU	3-1437397-5	362-BU	3-1437397-3
Switch Block	341	2-1437397-5	348	2-1437397-7	342	2-1437397-6
<b>Channel Mount (Dovetail Base)</b>						
Fuse Block with Puller	0351	1437397-9	0358	1-1437397-2	0352	1-1437397-0
Fuse Block without Puller	0361	1437397-4	0368	1-1437397-6	0362	1-1437397-5
Switch Block	0341	1437397-6	0348	1437397-8	0342	1437397-7

**Contact Type**



**Specifications**

Wire Range (AWG) Solid & Stranded	22-8	18-8	18-8
Wire Strip Length (in.)	—	1/2	1/2
Screw Type	8-32 binding head	8-32 pan head w/clamp	1/4"-28 set screw

**Ampacity**

Fuse Blocks	25A	25A	25A
Switch Blocks	15A	15A	15A

**End Sections**

No Contact, Flat Base	330-BU	2-14376397-4	330-BU	2-14376397-4	330-BU	2-14376397-4
No Contact, Dovetail Base	0330	14376397-5	0330	14376397-5	0330	14376397-5

**Comparison (Type of Block)**



**Direct Mount  
(Flat Base)**

**Channel Mount  
(Dovetail Base)**

**Notes:** Standard package is 10 pieces.

For factory assembled blocks, suffix Catalog Number with number of blocks desired (Maximum number of flat base preassembled sections is 6).

EXAMPLE:

Twelve strap screw, fuse block sections preassembled on channel = 035112.

Six flat tubular screw, switch blocks preassembled without channel for direct mounting = 3426

For blocks with two or more different contact sections, preassembled with other blocks, imprinting or special features, consult Technical Support.

Environmental contacts for highly corrosive atmospheres are available with Nickel plating on non-ferrous hardware. To order, prefix Catalog Number with "D".

Except  
Switch  
Blocks



LR25557 E34934

**Note:** All part numbers are RoHS Compliant.

## 300 Series, Fuse & Switch, Phenolic—Accessories

### Mounting Channel

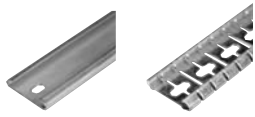

### Fuse Puller



Steel Channel	Break Away Steel	Pre-punched Aluminum Channel	Fuse Puller	3-Gang Fuse Puller
<b>Part Number</b>				
9-1437381-1 9-1437381-8	9-1437381-2	9-1437381-9 1437382-2	2-1437397-1	2-1437397-2
<b>Catalog Number</b>				
60-BU 63-BU	60-B-36	64 67	31-BU	32
<b>Standard Length</b>				
6 feet 3 feet	3 feet	6 feet 3 feet	—	—

### Channel Clamps



### Marking Accessories

Screw Channel Clamps	Universal Clamps	Snap-In Clamps	Ganging Rod	Coated Cloth Marking Tape
<b>Part Number</b>				
9-1437381-5	1437382-3	9-1437381-7	3-1437381-9	8-1437381-0
<b>Catalog Number</b>				
61	68	62	30	55-BU
<b>Standard Length</b>				
—	—	—	2 feet	50 feet

### Physical Properties

**Housing Material**—Phenolic, filled flame retardant  
**Color**—Black

### Contacts

**Material**—Copper alloy spring clips. Steel screws plated to resist corrosion in most industrial applications

**Strap Screw**—11/32" max. lug width

### Mechanical Properties

**Pitch (terminal spacing)**—0.75" [19.05]  
(16 circuits per foot)

### Switch Handles

**Material**—Polypropylene

**Color**—White

### Electrical Properties

**Operating Voltage**—Blocks meet 600V creepage and clearance requirements of NEMA, UL and CSA standards for general industrial control equipment and panelboards; withstand voltage exceeds IEEE switchgear standards for 750V

**Dielectric Strength (RH 40% @ sea level)**—300 volts/mil thickness per ASTM D149

**UL High Voltage Arc Tracking (inches/min.)**—.49-.58 [12.45-14.73]

**Fuse Size**—Any 13/32 x 1-1/2 in. [10.32 x 38.10] ferrule type cartridge fuse up to 25 amps, indicating or non-indicating, which meets Mil. Spec. F-15160, is recommended.

### Environmental Properties

**Max. Service Temperature**—150°C (302°F)

**Water Absorption (24hrs. % wt. gain)**—0.45% per ASTM D570

**Flammability Rating**—UL94V-1

**Chemical Resistance**—Resistant to acids, alkalies, and aliphatic hydrocarbons and ketones, per ASTM D543

**Radiation Resistance (ergs g-1 (C))**—2.7 x 10<sup>8</sup>

### UL Independent Testing Service Recognitions:

**Wire Sizes**—Solid or Stranded, Tubular Screw Cat. # 362-BU, 0362

1 #4 AWG, 1 #6 AWG, 1 #8 AWG,  
1 to 4 #10 AWG, 1 to 5 #12 AWG, 1 to 6  
#14 AWG, 1 to 6 #16 AWG, 1 to 8 #18 AWG

### Related Product Data

**Wire Pins and Ferrules**—Pages 135-137

For more information on AMP Standard Terminals and Splices or Quick-Connect FASTON Receptacles and Tabs, request Catalog 82042.

Cat #'s  
31 and  
32



E63810

**Note:** All part numbers are RoHS Compliant.

**300 Series, Fuse & Switch, Phenolic, Flat Base**

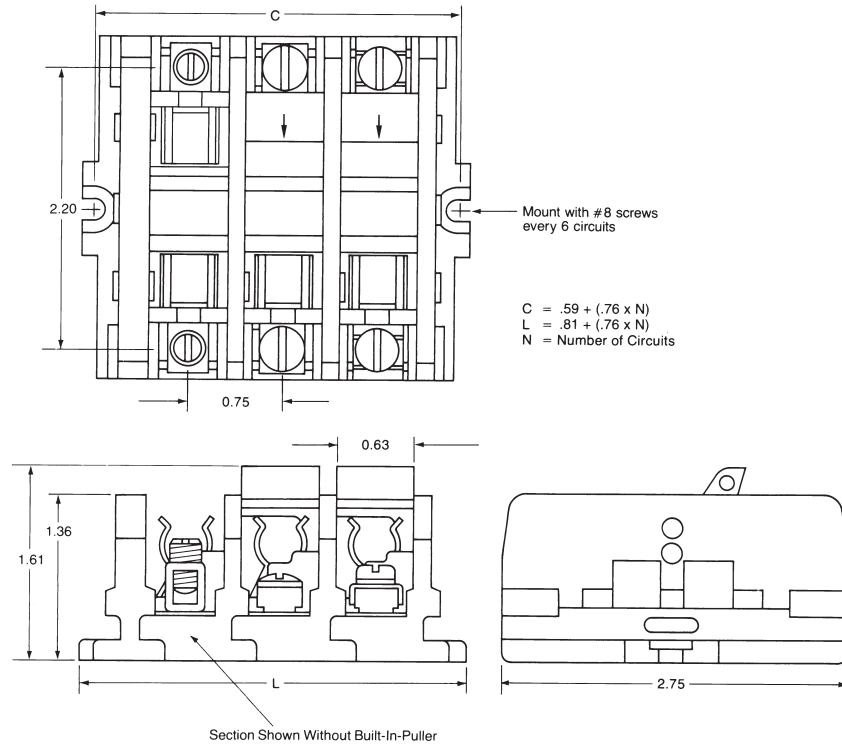

**Dovetail Base Mounted On Standard #60 Channel**

