

Part Number: **5553007F**

General Description

Series	555
Configuration	2 mm Lens
Description	2 mm Red Top View 5V/4mA Integral Resistor Single CBI
Package Options	Bulk Packaging
Sizes	2mm
Lamp Type	Single Color
Viewing	Top View
Polarity	Cathode Right
Lens Style	Non-Diffused



Absolute Maximum Ratings (Ta = 25°)

Solder Temperature	260° for 5 sec
Operating Temperature	-40 to +85
Storage Temperature	-55 to +100

Operating Characteristics

Color	 Red
Luminous Intensity Min	0.4
Luminous Intensity Typical	0.9
Test Current mA	5V
Emitted Color	Red



This is a
RoHS Compliant Product
[To learn more click here](#)

2mm

LED CBI® Circuit Board Indicator Single, Top View



555-3xxx

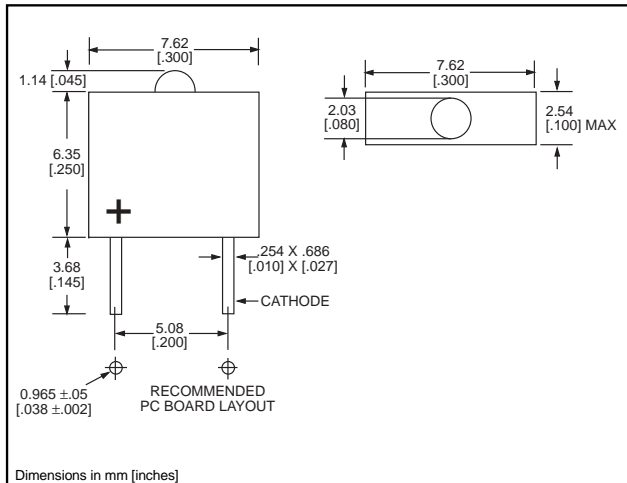

PART NO.

COLOR

GENERAL PURPOSE

555-3001	Red
555-3301	Green
555-3401	Yellow

INTEGRAL RESISTOR, VARIOUS VOLTAGES

555-3003	Red, 5V
555-3006	Red, 14V
555-3007	Red, 5V
555-3008	Red, 24V
555-3009	Red, 5V
555-3303	Green, 5V
555-3403	Yellow, 5V

Features

- Multiple CBIs form horizontal LED arrays on 2.54mm (0.100") center-lines
- High Contrast, UL 94 V-0 rated, black housing
- Oxygen index: 31.5%
- Polymer content: PBT, 0.090 g
- Housing stand-offs facilitate PCB cleaning
- Solderability per MIL-STD-202F, method 208F
- LEDs are safe for direct viewing per IEC 825-1, EN-60825-1
- Compatible with: 555-5xxx Quad Block

Tolerance note: As noted, otherwise:

- LED Protrusion: ± 0.04 mm [± 0.016]
- CBI Housing: ± 0.02 mm [± 0.008]

Typical Operating Characteristics (T_A = 25°C)

See LED data sheet for additional information

GENERAL PURPOSE

See Page 3-17 and 3-18 for Reference Only LED Drive Circuit Examples

See Page 3-19 for Pin Out

Part Number	Color	Peak Wavelength nm	I _v mcd	V _F Volts	Test Current (mA)	Viewing Angle 2θ _{1/2}	LED Data sheet	Page #
555-3001	Red	650	1.2	1.6	20	40°	2ND-9412	3-14
555-3301	Green	565	1	2.4	20	40°	2ND-9414	3-14
555-3401	Yellow	583	2	2.2	20	40°	2ND-9416	3-14

INTEGRAL RESISTOR, VARIOUS VOLTAGES

Part Number	Color	Peak Wavelength nm	I _v mcd	I _F mA	Test Voltage	Viewing Angle 2θ _{1/2}	LED Data sheet	Page #
555-3003	Red	650	1.9	6	5	40°	2RD-9614	3-15
555-3006	Red	650	3.1	10	14	40°	2RD-9619	3-16
555-3007	Red	650	.9	3	5	40°	2RD-9613	3-15
555-3008	Red	650	.9	3	24	40°	2RD-9623	3-16
555-3009	Red	650	.6	1	5	40°	2RD-9618	3-15
555-3303	Green	565	2.5	4.7	5	40°	2RD-9615	3-15
555-3403	Yellow	583	2.1	4.7	5	40°	2RD-9616	3-15

3