

Altech Corporation

Since 1984, Altech Corporation has grown to become a leading supplier of automation and industrial control components. Headquartered in Flemington, NJ, Altech has an experienced staff of engineering, manufacturing and sales personnel to provide the highest quality products with superior service. This is the Altech Commitment!

Altech's line of safety relays are manufactured by **DOLD**, a company well known in Europe for its quality safety relays. The products presented in this catalog will help you meet requirements of Machinery Directive EMD 89/392 EEC, important international safety standards, CE-marking demand, and more, when exporting your machinery or equipment.

What is a Safety Relay?

A safety relay contains force guided contacts; they are also known as captive, locked or positive guided contacts. Force guidance in a relay means that the contacts in a contact set must be mechanically linked together so that it is impossible for the NO (normally open) and NC (normally closed) contacts to be closed at the same time. The contacts are linked so that no one contact in a relay can change state without changing all the contacts in that relay. There must be a 0.5 mm minimum air gap between the open contacts for the entire service life of the relay, even in the case of a failure. The force guidance of the relay contacts must always be preserved even when a relay part fails to function correctly.

Our technical experts welcome the opportunity to answer your technical questions and provide solutions to your automation and control problems. Give us a call or visit www.altechcorp.com.

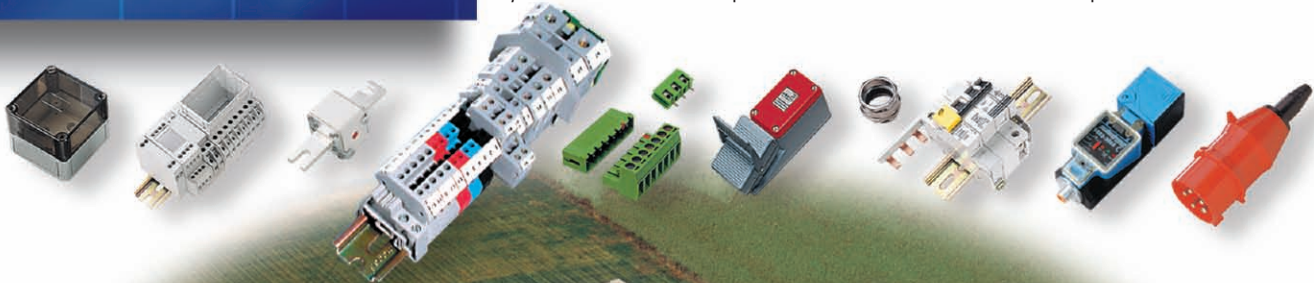

Quality Commitment

Altech's control components meet diverse national and international standards such as UL, NEC, CSA IEC VDE and more. Altech provides superior customer service and delivery through Total Quality Management and Continuous Process Improvement. Altech is ISO 9001 approved. We perform these services with honesty and integrity and are committed to achieve these goals.



OA/OW 5669
1 NO/1 NC, 2 CO, 2 NO, 2 NC

Page 6-7

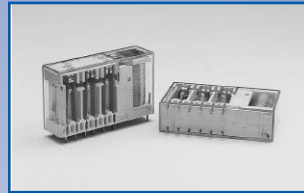

OA 5612
2 NO/4 NC, 3 NO/3 NC, 4 NO/2 NC

Page 18-19

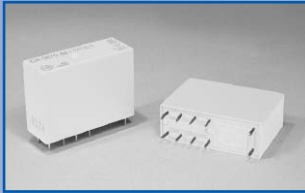

OA/OW 5670
2 NO/2 NC, 3 NO/1 NC

Page 8-9



OA 5601
2 NO/2 NC, 3 NO/1 NC

Page 20-21



OA 5621 / OA 5621S
3 NO/1 NC, 2 NO/2 NC

Page 10-11



OA 5602
2 NO/4 NC, 3 NO/3 NC, 4 NO/2 NC

Page 22-23



OA 5622 / OA 5622S
2 NO/4 NC, 3 NO/3 NC,
4 NO/2 NC, 5 NO/1 NC

Page 12-13



OA 5603
7 NO/1 NC, 6 NO/2 NC, 5 NO/3 NC,
4 NO/4 NC, 3 NO/5 NC, 2 NO/6 NC

Page 24-25

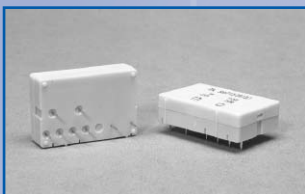

OA 5667 / OA 5667S
1 NO/1 NC, 2 CO

Page 14-15

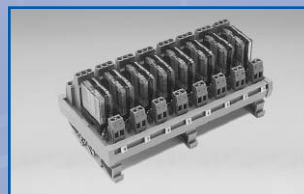

Safety Relay Modules
Bussed Channel
Isolated Channel

Page 26-31



OA 5611
2 NO/2 NC, 3 NO/1 NC

Page 16-17

Applications
Terminology
Accessories
Index
Terms & Conditions

Page 4-5
Page 32-34
Page 35
Page 36
Page 37

Applications

Safety relays with forced-guided contacts are the core components for safety devices and are indispensable when designing safety circuits. Safety devices are designed to protect man and machine as demanded in OSHA CFR 1910 Regulations “General Requirements for All Machinery”, and which is a mandatory requirement of the European Machinery Directive EMD 89/392 EEC.

DOLD safety relays, manufactured according to DIN EN 50205, are approved for use in safety applications to IEC 60204, EN 60204, DIN/VDE 0113, as well as Escalator Standard EN 115/06.95 and Elevator Standard EN 81 Part 1/10.86, TRA 101/07.80.

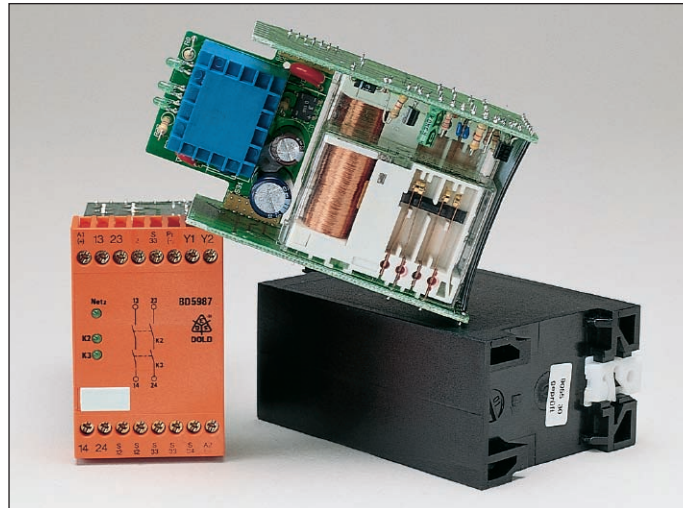

Typical Applications

- Emergency stop modules
- DIN Rail safety modules
- Safety door controls
- Two-hand operating devices
- Pressure mat controls
- Light barriers and curtains
- Speed controls
- Monitoring devices

Equipment controls systems for:

- Elevators and escalators
- Cranes
- Door and gate drive systems
- Printing and textile machinery
- Robots
- Stamping machines
- Medical equipment
- Cutting machines
- Rail transportation systems
- Signaling systems
- Press systems

WARNING

Improper use and installation of safety relays - modules into safety related circuitry without complying with the applicable regulations can cause serious injury to the operator.

Due to the wide range of potential users and customers' interpretation of the standards covering the applications of the safety relays described in this brochure, it is impossible for DOLD personnel or sales agents to be familiar with all safety and health standards and requirements that may apply to any specific application.

It is the responsibility of the user to determine the suitability of a safety relay for the intended application and to determine that the safety relay chosen and its installation will comply with all applicable safety and health regulations and codes.







DOLD SAFETY MODULES

Safety Modules are a mandatory requirement of European Machinery Directive EMD 89/392 EEC. This requirement is for risk reduction purposes in order to protect personnel and machinery. Built for the International Market and Global Machine Design, all fail-to-safe modules are designed with Dual Logic Circuits, each of which provides a safety function carried out by safety relays with forced guided contacts.

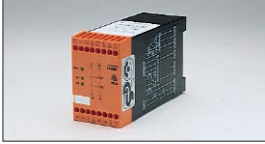

Safety Module Selector Guide

	Application	Features
BN 5983 	Emergency Stop Module Safety Gate Monitor	<ul style="list-style-type: none"> Coil Voltage: 24, 48, 110, 127, 230, 240V AC, or 24V DC Max. Switching Current: 10A Max. Switching Voltage: 415V AC, 250V DC Dimension: 100mm 3 NO output contacts LED indicator for channels 1 and 2 Quick disconnect terminal strips Front mounted fuse (optional)
BD 5987 	Emergency Stop Module Safety Gate Monitor	<ul style="list-style-type: none"> Coil Voltage: 24, 48, 110, 127, 230, 240V AC, or 24V DC Max. Switching Current: 10A Max. Switching Voltage: 250V AC, 250V DC Dimension: 45mm 2 NO output contacts LED indicator for channel 1, channel 2, and line voltage Internal overvoltage protection with auto-reset Line fault detection at ON pushbutton Cross fault detection (optional)
BO 5988 	Emergency Stop Module Safety Gate Monitor	<ul style="list-style-type: none"> Coil Voltage: DC 24V+ AC 48/110/230 or 240V, DC 24V Max. Switching Current: 10A Max. Switching Voltage: 250V AC, 250V DC Dimension: 100mm 6 NO output contacts LED indicator for channel 1, channel 2 and line voltage Internal overvoltage protection with auto-reset Quick disconnect terminal strips Line fault detection at ON pushbutton Cross fault detection (optional) Time delay optional
BD 5935 	Emergency Stop Module Safety Gate Monitor	<ul style="list-style-type: none"> Coil Voltage: 24, 48, 110, 127, 230, 240V AC, or 24V DC Max. Switching Current: 10A Max. Switching Voltage: 250V AC, 250V DC Dimension: 45mm 3 NO output contacts LED indicator for channel 1, channel 2 and line voltage Internal overvoltage protection with auto-reset Quick disconnect terminal strips Line fault detection at ON pushbutton Cross fault and auto-on selection switch located behind front panel
BD 5985N 	Safety Gate Monitor	<ul style="list-style-type: none"> Coil Voltage: 24, 42, 110, 230, 240V AC, 24V DC Max. Switching Current: 10A Max. Switching Voltage: 250V AC, 250V DC Dimension: 45mm 2 NO output contacts Internal overvoltage protection with auto-reset Gate closing time 3 s
BD 5980N 	2-Hand Safety Module	<ul style="list-style-type: none"> Coil Voltage: 24, 42, 110, 230, 240V AC, 24V DC, 24V AC/DC Max. Switching Current: 10A Max. Switching Voltage: 250V AC, 250V DC Dimension: 45mm 2 NO output contacts Internal overvoltage protection with auto-reset Simultaneous input closing demand of 500 ms
BN 3081 	Extension Module	<ul style="list-style-type: none"> Coil Voltage: 110, 230V AC, 24V DC Max. Switching Current: 10A Max. Switching Voltage: 415V AC, 250V DC Dimension: 100mm 7 NO output contacts LED indicator for channels 1 and 2 Quick disconnect terminal strips

Please call us for other DOLD products

Time Control Relays • Monitoring Relays • Interface Relays • Control Relays



Safety Relay

OA/OW 5669

Features

- 2 output contacts
- International approvals: TÜV, CSA, UL, cUL
- Quality control check for each safety relay
- Forced-guided contacts, all gold flash plated
- Contact Gap > 0.5 mm throughout life of relay
- Various contact materials, mixed contact material optional
- High coil voltage range
- High breakdown Voltage: contact/coil > 4 KV
- High Creeping Distance: contact/coil > 8 mm
- Protection Rating
 OA Version: IP 40, flow solder proof
 OW Version: IP 67, washable
- Custom design available,
 - coil voltage
 - coil resistance,
 - contact pressure
 - operate/release time

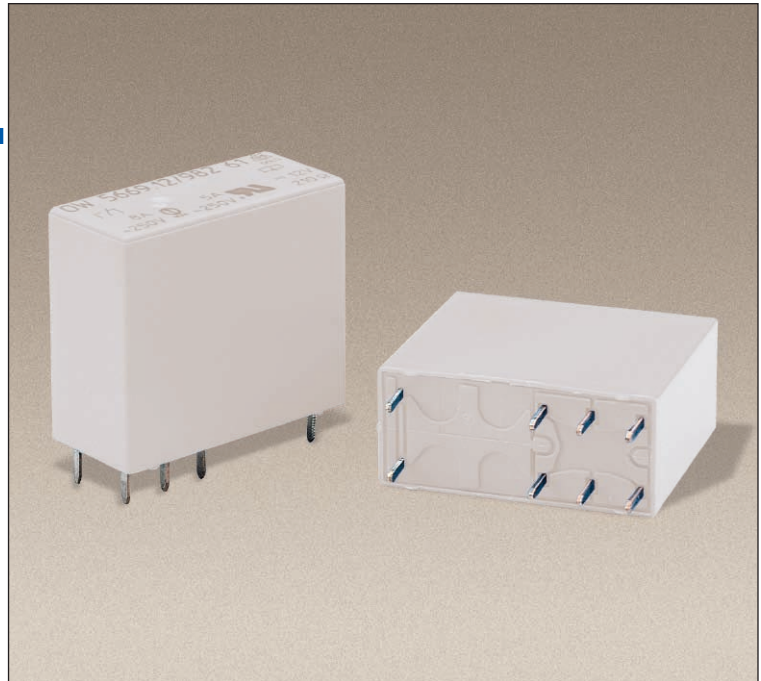

Technical Data

- **Nominal Coil Voltage**5, 6, 12, 20, 24, 48, 60, 110, DC
- **Coil Power Dissipation**0.7 W
- **Max. Switching Voltage**250V DC, 400V AC
- **Max. Switching Current**8 A (2 x 5A simultaneous)
- **Max. Switching Power — DC**200W (2 x 160W simultaneous)
- **Max. Switching Power — AC**2000VA (2 x 1250VA simultaneous)
- **Contact Switching Rate**10 operations per second
- **Relay Operate Time** ≤ 15 ms
- **Relay Release Time** ≤ 12 ms
- **Operation Vibration**0.35 mm Ampl. max @ 10...55Hz, 5g max
- **Contact Arrangements**1NO/1NC, 2CO, 2NO, 2NC
- **Contact Material**AgNi10+0.2µmAu Standard
AgSnO₂+0.2µmAu, AgNi0.15+5µmAu Optional
- **Mechanical Life**50x10⁶ operation cycles
- **Electrical Life**AgSnO₂ >2x10⁵, AgNi10 >10⁵
operation cycles @ 230V AC, 6A, cos φ=1
- **Ambient Temperature**-20...+85°C
- **Cover Material**Polyamide 6
- **Weight**15 g
- More detailed data upon request

Diagrams

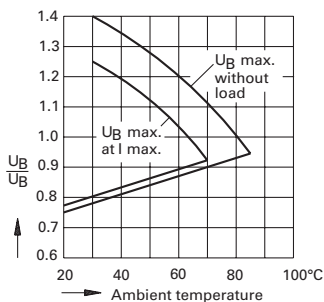

Relay operation voltage vs. ambient temperature

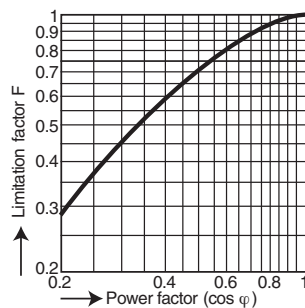

Limitation factor for inductive loads
 Operations = Operations (ohmic) x limitation factor F

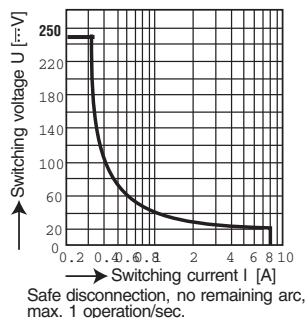

Maximum switching power curve

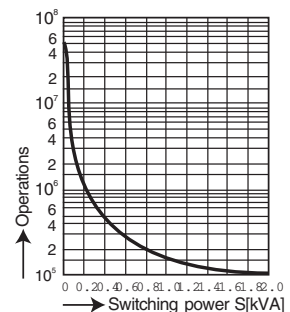

Mechanical life

Safety Relay 5669 Data

Relay Data			Ordering Information			
Rated Voltage	Voltage Range	Coil Resistance	1 NO/1 NC Type	2 CO Type	2 NO Type	2 NC Type
5V	4.0 - 8.0V	36 Ω	56.O□69.0511□	56.O□69.0500□	56.O□69.0520□	56.O□69.0502□
6V	4.8 - 9.6V	50 Ω	56.O□69.0611□	56.O□69.0600□	56.O□69.0620□	56.O□69.0602□
10V	8.0 - 16.0V	150 Ω	56.O□69.1011□	56.O□69.1000□	56.O□69.1020□	56.O□69.1002□
12V	9.6 - 19.2V	210 Ω	56.O□69.1211□	56.O□69.1200□	56.O□69.1220□	56.O□69.1202□
20V	16.0 - 32.0V	580 Ω	56.O□69.2011□	56.O□69.2000□	56.O□69.2020□	56.O□69.2002□
24V	19.2 - 38.4V	820 Ω	56.O□69.2411□	56.O□69.2400□	56.O□69.2420□	56.O□69.2402□
48V	38.4 - 76.8V	3200 Ω	56.O□69.4811□	56.O□69.4800□	56.O□69.4820□	56.O□69.4802□
60V	48.0 - 96.0V	5200 Ω	56.O□69.6011□	56.O□69.6000□	56.O□69.6020□	56.O□69.6002□
110V	88.0 - 176.0V	18000 Ω	56.O□69.1111□	56.O□69.1100□	56.O□69.1120□	56.O□69.1102□

Protection Class, Example:

- A** IP 40, Flow Solder Proof
- W** IP 67, Washable

Contact Material, Example:

- C** AgSnO₂+2μmAu
- N** AgNi10+2μmAu
- S** AgNi0.15+5μmAu

Footprints

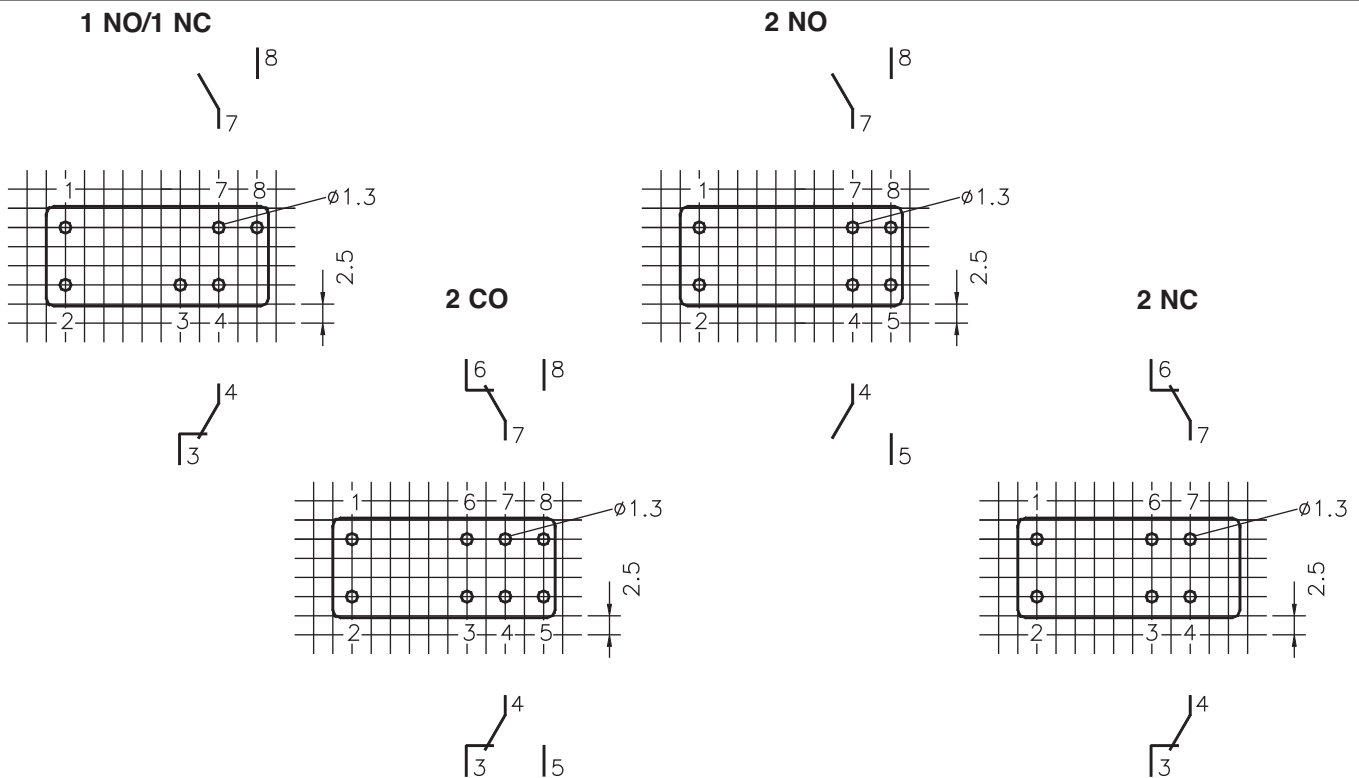

Dimensions

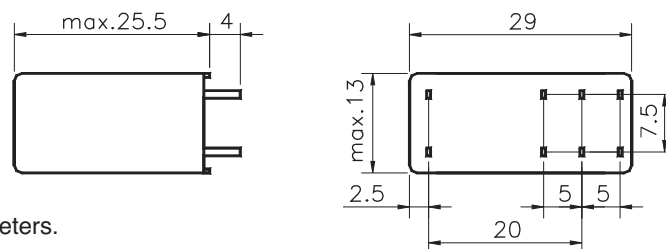

Note: All dimensions are shown in millimeters.
To convert to inches, divide by 25.4.

Safety Relay OA/OW 5670

Features

- 4 output contacts
- International approvals: TÜV, UL, cUL
- Quality control check for each safety relay
- Forced-guided contacts, all gold flash plated
- Contact Gap > 0.5 mm throughout life of relay
- Various contact materials, mixed contact material optional
- High coil voltage range
- High breakdown Voltage: contact/coil \geq 4 KV
- High Creeping Distance: contact/coil \geq 8 mm
- Protection Rating
OA Version: IP 40, flow solder proof
OW Version: IP 67, washable
- Custom design available,
-coil voltage -coil resistance,
-contact pressure -operate/release time



Technical Data

- **Nominal Coil Voltage**6, 12, 20, 24, 48, 60, 110, DC
- **Coil Power Dissipation**1.0 W
- **Max. Switching Voltage**.....250V DC, 400V AC
- **Max. Switching Current**6 A (3 x 6A simultaneous)
- **Max. Switching Power — DC**160W
- **Max. Switching Power — AC**1500VA
- **Contact Switching Rate**10 operations per second
- **Relay Operate Time**11 ms
- **Relay Release Time**6 ms
- **Operation Vibration**.....0.35 mm Ampl. max
.....@ 10...200Hz, 5g max
- **Contact Arrangements**.....2NO/2NC, 3NO/1NC
- **Contact Material**AgNi10+0.2 μ mAu Standard
.....AgSnO₂+0.2 μ mAu, AgNi0.15+5 μ mAu Optional
- **Mechanical Life** \geq 50x10⁶ operation cycles
- **Electrical Life**.....AgSnO₂ >2x10⁵, AgNi10 >1.2x10⁵
.....operation cycles @ 230V AC, 6A, cos φ =1
- **Ambient Temperature**-25...+60°C
- **Cover Material**.....Polyamide 6
- **Weight**.....20 g
- More detailed data upon request

Diagrams

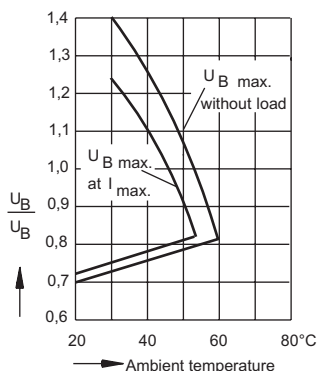

Relay operation voltage vs. ambient temperature

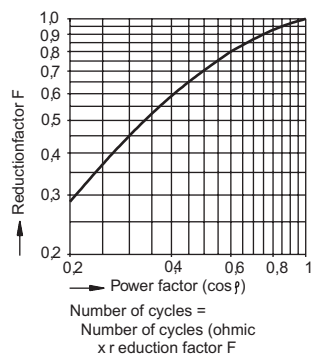

Limitation factor for inductive loads

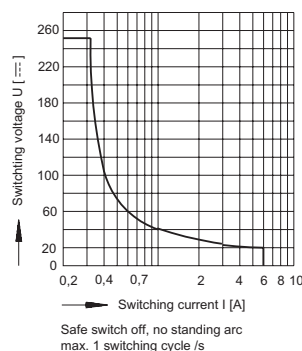

Maximum switching power curve

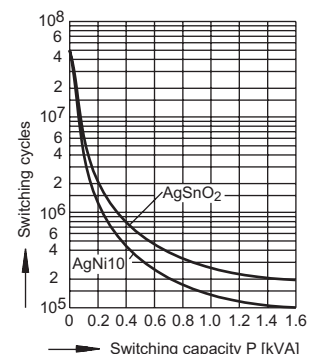

Mechanical life

Safety Relay 5670 Data

Relay Data			Ordering Information	
Rated Voltage	Voltage Range	Coil Resistance	2 NO/2 NC Type	3 NO/1 NC Type
6V	4.2 - 8.4V	36 Ω	56.O□70.0622□	56.O□70.0631□
12V	8.4 - 16.8V	150 Ω	56.O□70.1222□	56.O□70.1231□
20V	14.0 - 28.0V	400 Ω	56.O□70.2022□	56.O□70.2031□
24V	16.8 - 33.6V	580 Ω	56.O□70.2422□	56.O□70.2431□
48V	33.6 - 67.2V	2300 Ω	56.O□70.4822□	56.O□70.4831□
60V	42.0 - 84.0V	3600 Ω	56.O□70.6022□	56.O□70.6031□
110V	77.0 - 154.0V	12100 Ω	56.O□70.1122□	56.O□70.1131□

Protection Class, Example:

- A** IP 40, Flow Solder Proof
- W** IP 67, Washable

Contact Material, Example:

- C** AgSnO₂+2μmAu
- N** AgNi10+.2μmAu
- S** AgNi0.15+5μmAu

Footprints

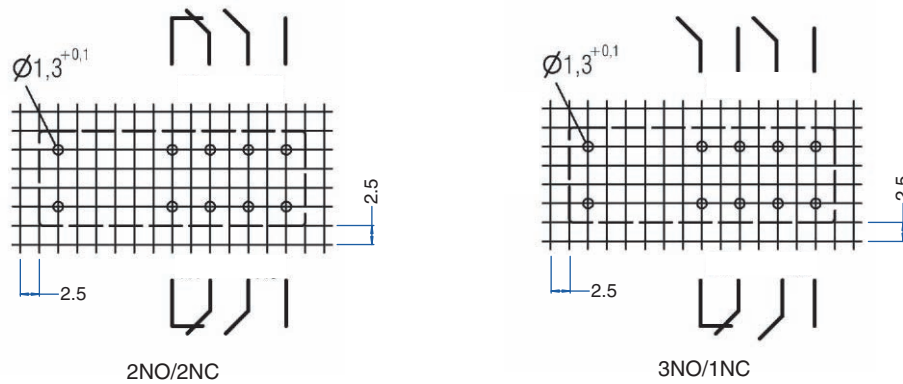

Dimensions

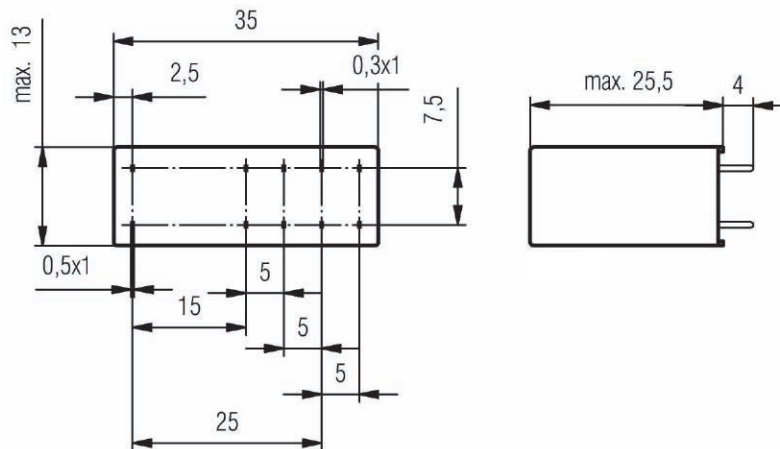

Note: All dimensions are shown in millimeters.
To convert to inches, divide by 25.4.

Safety Relay

OA 5621 / OA 5621S

Features

- 4 output contacts
- International approvals: TÜV, UL, cUL
- Quality control check for each safety relay
- Forced-guided contacts, all gold flash plated
- Contact Gap > 0.5 mm throughout life of relay
- Various contact materials, mixed contact material optional
- High coil voltage range
- High breakdown Voltage: contact/coil ≥ 4 kV
- High Creeping Distance: contact/coil ≥ 5.5 mm
contact/contact ≥ 5.5 mm
- Protection Rating IP 67, washable
- Custom design available,
 - coil voltage
 - coil resistance,
 - contact pressure
 - operate/release time
 - double gold contacts
- S-Type
higher external clearance and creeping distance:
contact/contact ≥ 7.5 mm



GERMANY



USA/CANADA
E107778

Technical Data

- **Nominal Coil Voltage**.....6, 12, 24, 48, 60, 110, DC
- **Coil Power Dissipation**0.6 W
- **Max. Switching Voltage**.....250V DC, 400V AC
- **Max. Switching Current**8 A (3 x 8A simultaneous)
- **Max. Switching Power – DC**200W
- **Max. Switching Power – AC**2000VA
- **Contact Switching Rate**10 operations per second
- **Relay Operate Time**12 ms
- **Relay Release Time**8 ms
- **Operation Vibration**0.35 mm Ampl. max
.....@ 10...200Hz, 5g max
- **Contact Arrangements**.....3NO/1NC, 2NO/2NC
- **Contact Material**AgNi10+0.2 μ mAu Standard
.....AgSnO₂+0.2 μ mAu, AgNi10+5 μ mAu Optional
- **Mechanical Life**>20x10⁶ operation cycles
- **Electrical Life**.....AgSnO₂ >1.5x10⁵, AgNi10 >1.0x10⁵
.....operation cycles @ 230V AC, 8A, cos φ =1
- **Ambient Temperature**-25...+80°C
- **Cover Material**.....Polyamide 6
- **Weight**.....35 g
- More detailed data upon request

Diagrams

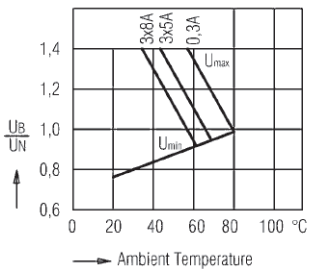

Relay operation voltage vs. ambient temperature

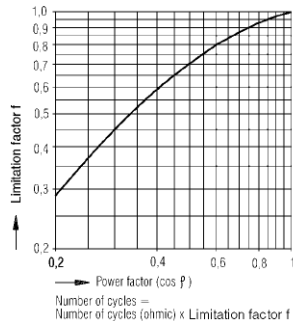

Limitation factor for inductive loads

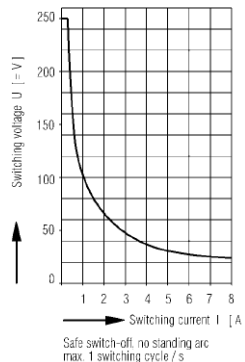

Maximum switching power curve

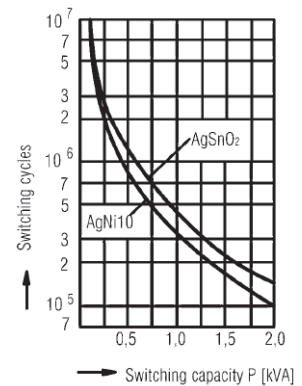

Mechanical life

Safety Relay 5621 Data

Relay Data			Ordering Information			
Rated Voltage	Voltage Range	Coil Resistance	3 NO/1 NC Type	2 NO/2 NC Type	3 NO/1 NC S-Type	2 NO/2 NC S-Type
6V	4.5 - 8.4V	60 Ω	56.OA21.0631□	56.OA21.0622□	56.OA21S.0631□	56.OA21S.0622□
12V	9.0 - 16.8V	240 Ω	56.OA21.1231□	56.OA21.1222□	56.OA21S.1231□	56.OA21S.1222□
24V	18.0 - 33.6V	960 Ω	56.OA21.2431□	56.OA21.2422□	56.OA21S.2431□	56.OA21S.2422□
48V	36.0 - 67.2V	3840 Ω	56.OA21.4831□	56.OA21.4822□	56.OA21S.4831□	56.OA21S.4822□
60V	45.0 - 84.0V	6000 Ω	56.OA21.6031□	56.OA21.6022□	56.OA21S.6031□	56.OA21S.6022□
110V	82.5 - 154.0V	20000 Ω	56.OA21.1131□	56.OA21.1122□	56.OA21S.1131□	56.OA21S.1122□

Contact Material, Example: CAgSnO₂+2μmAu

NAgNi10+.2μmAu

SAgNi10+5μmAu

Footprints

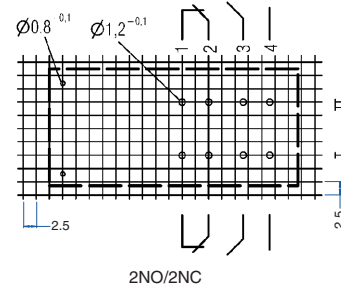
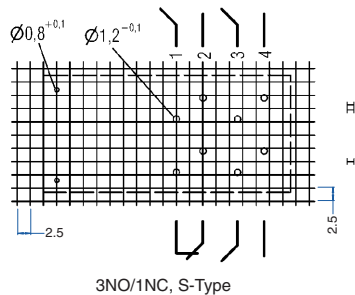
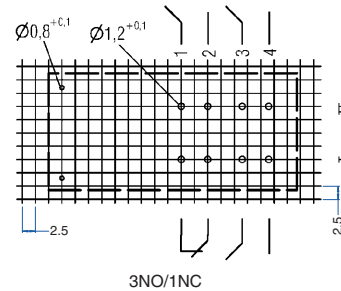
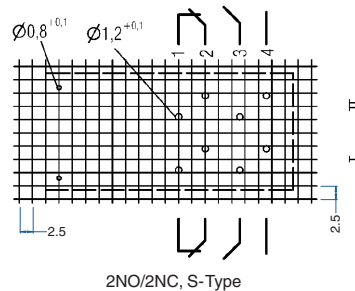

Dimensions

S-Type

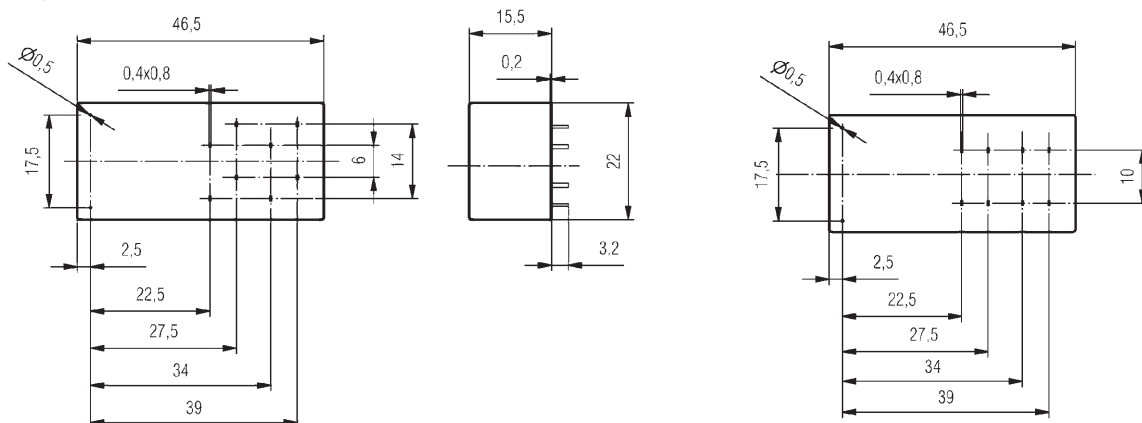

Note: All dimensions are shown in millimeters.
To convert to inches, divide by 25.4.

Safety Relay

OA 5622 / OA 5622S

Features

- 6 output contacts
- International approvals: TÜV, UL, cUL
- Quality control check for each safety relay
- Forced-guided contacts, all gold flash plated
- Contact Gap > 0.5 mm throughout life of relay
- Various contact materials, mixed contact material optional
- High coil voltage range
- High breakdown Voltage: contact/coil ≥ 4 kV
- High Creeping Distance: contact/coil ≥ 5.5 mm
contact/contact ≥ 5.5 mm
- Protection Rating IP 67, washable
- Custom design available,
 - coil voltage
 - coil resistance,
 - contact pressure
 - operate/release time
 - double gold contacts
- S-Type
higher external clearance and creeping distance:
contact/contact ≥ 7.5 mm

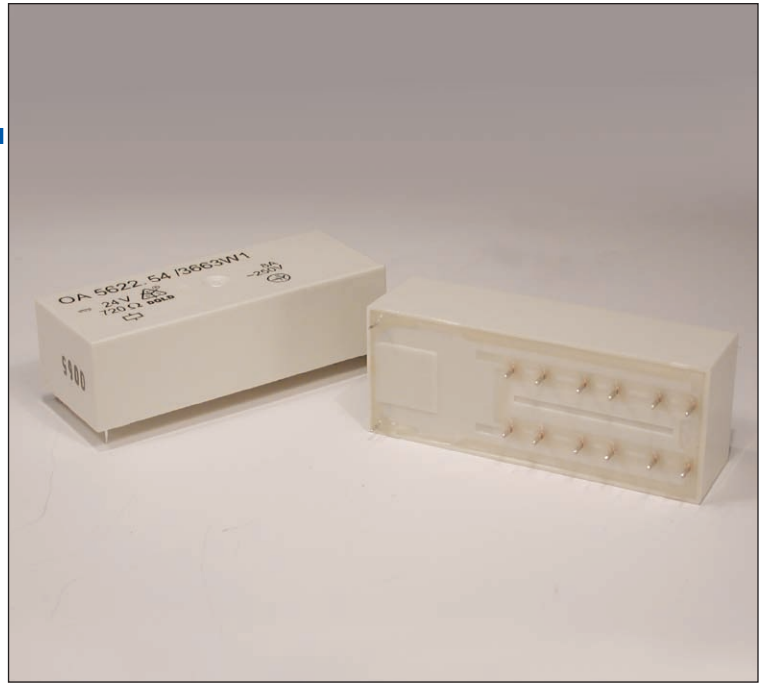

GERMANY



USA/CANADA
E107778

Technical Data

- **Nominal Coil Voltage**6, 12, 24, 48, 60, 110, DC
- **Coil Power Dissipation**0.8 W
- **Max. Switching Voltage**250V DC, 400V AC
- **Max. Switching Current**8 A (5 x 8A simultaneous)
- **Max. Switching Power – DC**200W
- **Max. Switching Power – AC**2000VA
- **Contact Switching Rate**10 operations per second
- **Relay Operate Time**12 ms
- **Relay Release Time**8 ms
- **Operation Vibration**0.35 mm Ampl. max
.....@ 10...200Hz, 5g max
- **Contact Arrangements**2NO/4NC, 3NO/3NC, 4NO/2NC, 5NO/1NC
- **Contact Material**AgNi10+0.2 μ mAu Standard
.....AgSnO₂+0.2 μ mAu, AgNi10+5 μ mAu Optional
- **Mechanical Life**>20x10⁶ operation cycles
- **Electrical Life**AgSnO₂ >10⁵, AgNi10 >0.75x10⁵
.....operation cycles @ 230V AC, 8A, cos φ =1
- **Ambient Temperature**-25...+80°C
- **Cover Material**Polyamide 6
- **Weight**38 g
- More detailed data upon request

Diagrams

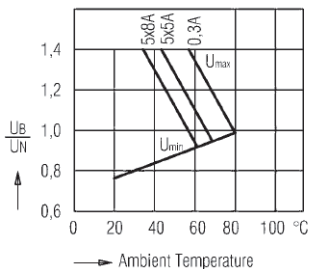

Relay operation voltage vs. ambient temperature

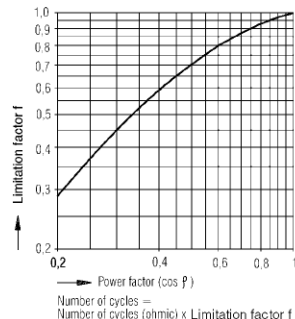

Limitation factor for inductive loads

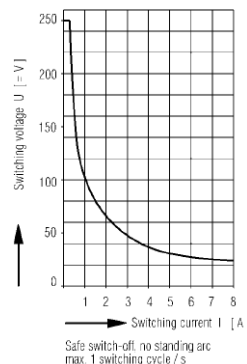

Maximum switching power curve

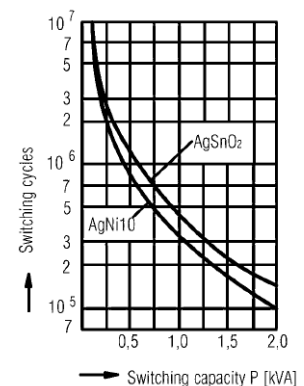

Mechanical life

Relay Data

Ordering Information

Rated Voltage	Voltage Range	Coil Resistance	2 NO/4 NC Type	3 NO/3 NC Type	4 NO/2 NC Type	5 NO/1 NC Type
6V	4.5 - 8.4V	45 Ω	56.OA22.0624□	56.OA22.0633□	56.OA22.0642□	56.OA22.0651□
12V	9.0 - 16.8V	180 Ω	56.OA22.1224□	56.OA22.1233□	56.OA22.1242□	56.OA22.1251□
24V	18.0 - 33.6V	720 Ω	56.OA22.2424□	56.OA22.2433□	56.OA22.2442□	56.OA22.2451□
48V	36.0 - 67.2V	2880 Ω	56.OA22.4824□	56.OA22.4833□	56.OA22.4842□	56.OA22.4851□
60V	45.0 - 84.0V	4500 Ω	56.OA22.6024□	56.OA22.6033□	56.OA22.6042□	56.OA22.6051□
110V	82.5 - 154.0V	15125 Ω	56.OA22.1124□	56.OA22.1133□	56.OA22.1142□	56.OA22.1151□

For S-Type:

Please specify **S** when ordering:

Example: 56.OA22S.____□

Contact Material, Example: □AgSnO₂+2μmAu

□AgNi10+.2μmAu

□AgNi10+5μmAu

Footprints

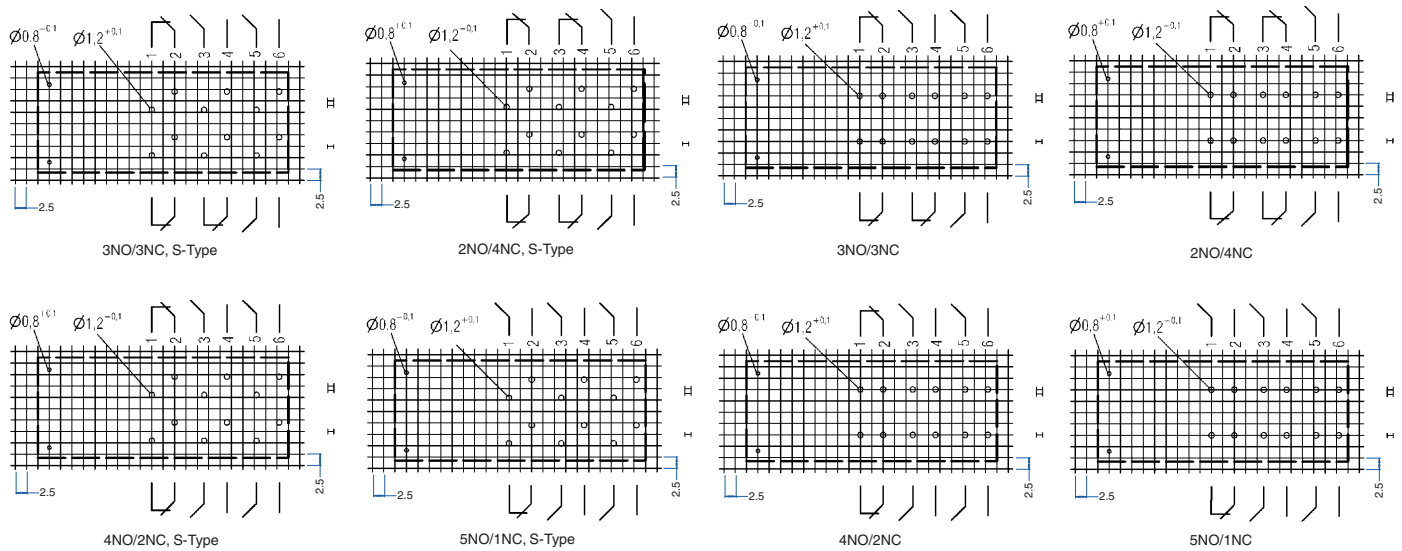

Dimensions

S-Type

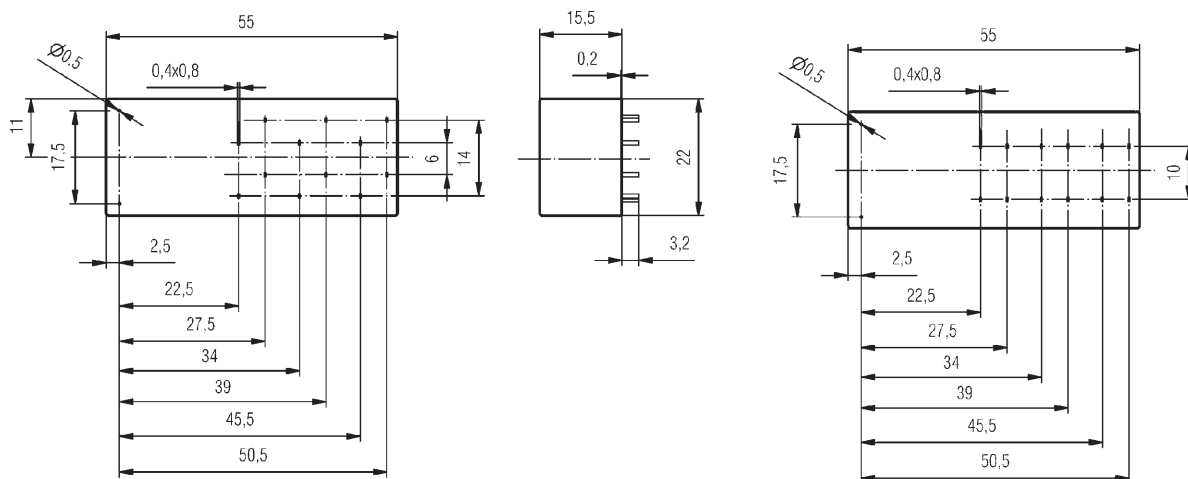

Note: All dimensions are shown in millimeters.
To convert to inches, divide by 25.4.

Safety Relay

OA 5667 / OA 5667S

Features

- 2 output contacts
- International approvals: TÜV, UL, cUL
- Quality control check for each safety relay
- Forced-guided contacts, all gold flash plated
- Contact Gap > 0.5 mm throughout life of relay
- Various contact materials, mixed contact material optional
- High coil voltage range
- High breakdown Voltage:
 - contact/coil \geq 4 KV
 - contact/contact \geq 2.5 KV
 - contact/contact \geq 4 KV; S-Type
- High Creeping Distance:
 - contact/coil > 8 mm
 - contact/contact > 4.5 mm; S-Type 5.5 mm
- Custom design available,
 - coil voltage -coil resistance,
 - contact pressure -operate/release time

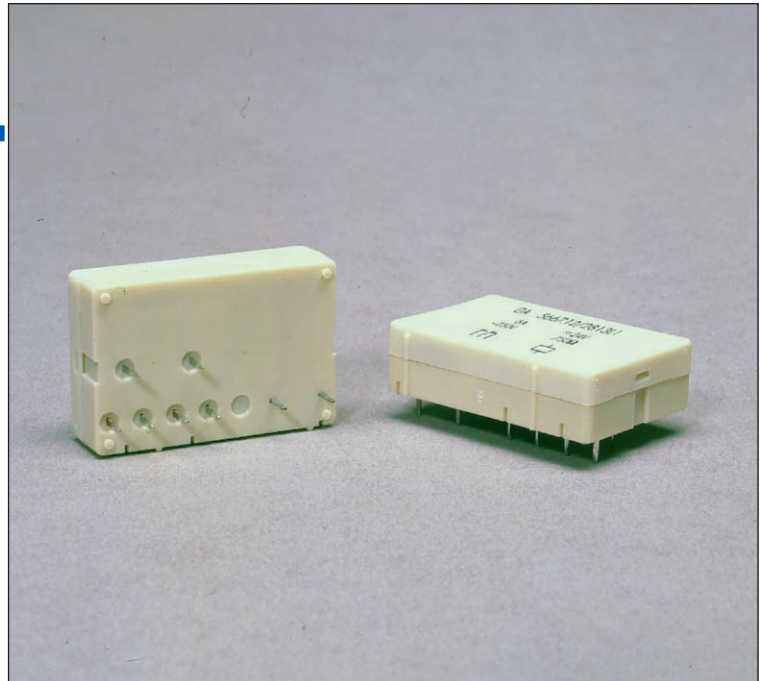

Technical Data

- **Nominal Coil Voltage**5, 6, 12, 20, 24, 48, 60, 110 DC
- **Coil Power Dissipation**0.75 W
- **Max. Switching Voltage**250V DC, 400V AC
- **Max. Switching Current**6A (2 x 6A simultaneous)
- **Max. Switching Power – DC**200W (2 x 160W simultaneous)
- **Max. Switching Power – AC**1500VA (2 x 1500VA simultaneous)
- **Contact Switching Rate**10 operations per second
- **Relay Operate Time**10 ms
- **Relay Release Time**6 ms
- **Operation Vibration**0.35 mm Ampl. max @ 10...100Hz, 4g max
- **Contact Arrangements**1 NO/1 NC, 2CO
- **Contact Material**AgNi10+0.2 μ mAu Standard
.....AgSnO₂+0.2 μ mAu, AgNi10+5 μ mAu Optional
- **Mechanical Life** $\geq 10^7$ operation cycles
- **Electrical Life**AgSnO₂ > 1.25x10⁵, AgNi10 > 10⁵ operation cycles @ 250V AC, 6A, cos φ =1
- **Ambient Temperature**-25...+70°C
- **Protection Rating**IP40
- **Cover Material**Thermoplast
- **Weight**16 g
- More detailed data upon request

Diagrams

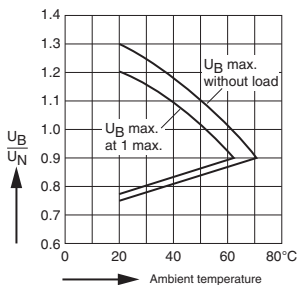

Relay operation voltage vs. ambient temperature

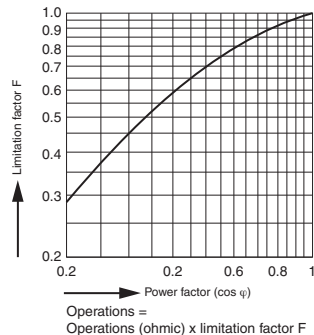

Limitation factor for inductive loads

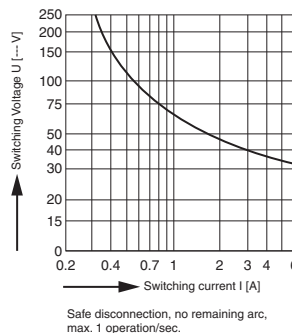

Maximum switching power curve

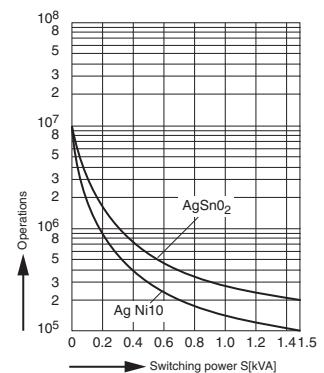

Mechanical life

Safety Relay 5667/5667S Data

Relay Data

Ordering Information

Rated Voltage	Voltage Range	Coil Resistance	1 NO/1 NC Type	2 CO Type	1 NO/1 NC S-Type	2 CO S-Type
5V	3.75- 6.5V	33 Ω	56.OA67.0511□	56.OA67.0500□	56.OA67S.0511□	56.OA67S.0500□
6V	4.5 - 7.8V	48 Ω	56.OA67.0611□	56.OA67.0600□	56.OA67S.0611□	56.OA67S.0600□
12V	9.0 - 15.6V	183 Ω	56.OA67.1211□	56.OA67.1200□	56.OA67S.1211□	56.OA67S.1200□
20V	15.0- 26.0V	575 Ω	56.OA67.2011□	56.OA67.2000□	56.OA67S.2011□	56.OA67S.2000□
24V	18.0 - 31.2V	750 Ω	56.OA67.2411□	56.OA67.2400□	56.OA67S.2411□	56.OA67S.2400□
48V	36.0 - 62.4V	3200 Ω	56.OA67.4811□	56.OA67.4800□	56.OA67S.4811□	56.OA67S.4800□
60V	45.0 - 78.0V	4700 Ω	56.OA67.6011□	56.OA67.6000□	56.OA67S.6011□	56.OA67S.6000□
110V	82.5 - 143.5V	15300 Ω	56.OA67.1111□	56.OA67.1100□	56.OA67S.1111□	56.OA67S.1100□

Contact Material, Example: □AgSnO₂+2μmAu

□AgNi10+.2μmAu

□AgNi10+5μmAu

Footprints

2 CO

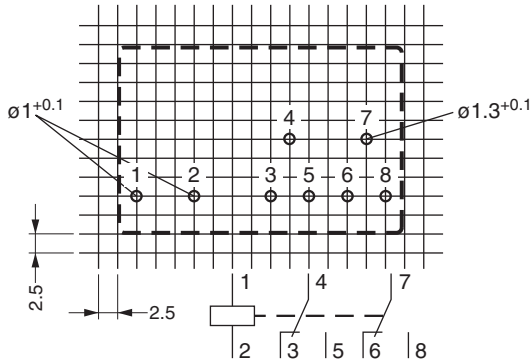

2 CO S-Type

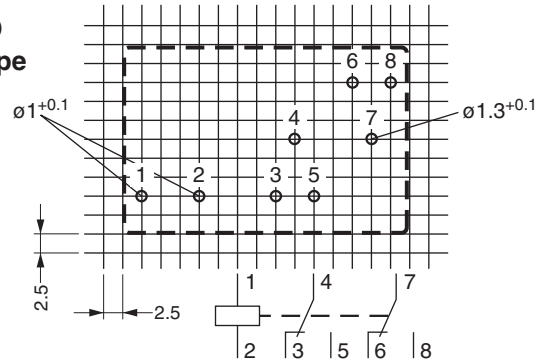

1 NO/1 NC

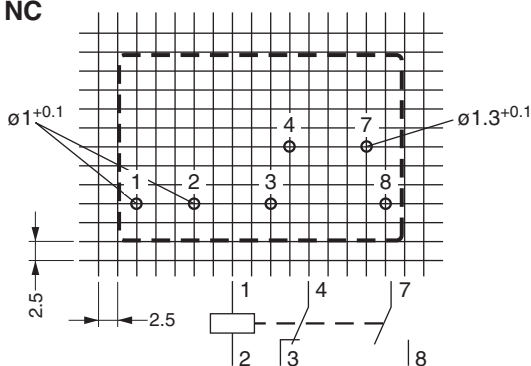

1 NO/1 NC S-Type

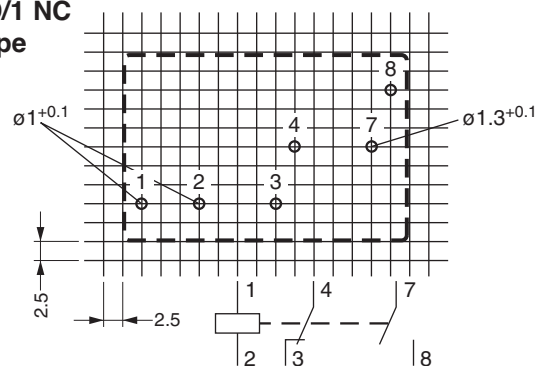

Dimensions

Note: All dimensions are shown in millimeters.
To convert to inches, divide by 25.4.

2 CO

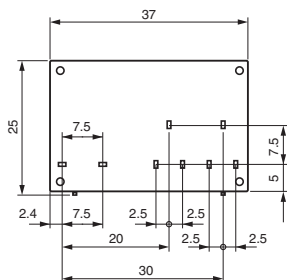

1 NO/1 NC

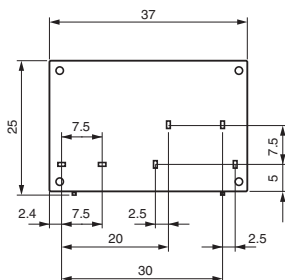

2 CO, S-Type

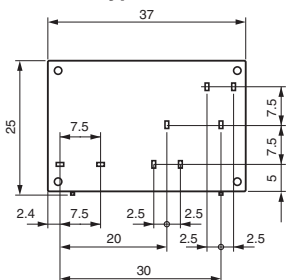

1 NO/1 NC, S-Type

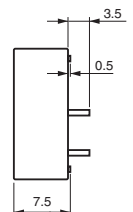
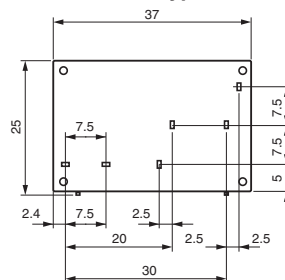

Safety Relay

OA 5611

Features

- 4 output contacts
- International approvals: TÜV, UL, cUL, CSA
- Quality control check for each safety relay
- Forced-guided contacts, all gold flash plated
- Contact Gap > 0.5 mm throughout life of relay
- Various contact materials, mixed contact material optional
- High coil voltage range
- High switching voltage
- High breakdown voltage: contact/coil > 4 KV
- High creeping distance: contact/coil > 8 mm
- Crown contacts
- Solid connection between coil and contact housing
- Compact size
- Custom design available,
 - coil voltage -IP67 washable
 - contact pressure -coil resistance
 - operate/release time
 - low power dissipation models
 - Manual test relay (slide activated)



Technical Data

- **Nominal Coil Voltage**6, 12, 24, 48, 60, 110, DC
- **Coil Power Dissipation**0.6 W
- **Max. Switching Voltage**.....250V DC, 400 V AC
- **Max. Switching Current**8 A
- **Max. Switching Power – DC**200W
- **Max. Switching Power – AC**2000VA
- **Contact Switching Rate**10 operations per second
- **Relay Operate Time**20 ms
- **Relay Release Time**6 ms
- **Operation Vibration**.....0.35 mm Ampl. max @ 10...200Hz, 3g max
- **Protection Rating**IP 40
- **Contact Arrangements**.....2NO/2NC, 3NO/1NC
- **Contact Material**.....AgNi10+0.2µmAu, AgSnO₂+0.2µmAu, AgNi10+5µmAu
- **Mechanical Life**50x10⁶ operation cycles
- **Electrical Life**.....AgSnO₂ >3x10⁵, AgNi10 >2x10⁵ operation cycles @ 230V AC, 5A, cos φ=1
 AgSnO₂ >1.5x10⁵, AgNi10 >10⁵ operation cycles @ 230V AC, 8A, cos φ=1
- **Ambient Temperature**-25...+85°C
- **Cover Material**.....Thermoplast
- **Weight**.....35 g
- More detailed data upon request

Diagrams



Relay operation voltage vs. ambient temperature



Limitation factor for inductive loads
 Operations = Operations (ohmic) x limitation factor F



Maximum switching power curve
 Safe disconnection, no remaining arc, max. 1 operation/sec.



Mechanical life

Safety Relay 5611 Data

Relay Data			Ordering Information	
Rated Voltage	Voltage Range	Coil Resistance	2 NO/2 NC Type	3 NO/1 NC Type
6V	4.2 - 8.4V	56 Ω	56.OA11.0622□	56.OA11.0631□
12V	8.4 - 16.8V	240 Ω	56.OA11.1222□	56.OA11.1231□
24V	16.8 - 33.6V	960 Ω	56.OA11.2422□	56.OA11.2431□
48V	33.6 - 67.2V	3840 Ω	56.OA11.4822□	56.OA11.4831□
60V	42.0 - 84.0V	6000 Ω	56.OA11.6022□	56.OA11.6031□
110V	77.0 - 154.0V	20150 Ω	56.OA11.1122□	56.OA11.1131□

Contact Material, Example: CAgSnO₂+2μmAu
NAgNi10+.2μmAu
SAgNi10+5μmAu

Footprints



Dimensions



Note: All dimensions are shown in millimeters.
 To convert to inches, divide by 25.4.

Safety Relay OA 5612

Features

- 6 output contacts
- International approvals: TÜV, UL, cUL, CSA
- Quality control check for each safety relay
- Forced-guided contacts, all gold flash plated
- Contact Gap > 0.5 mm throughout life of relay
- Various contact materials, mixed contact material optional
- High coil voltage range
- Very high switching voltage
- High breakdown voltage: contact/coil > 4 KV
- High creeping distance: contact/coil > 8 mm
- Crown contacts
- Solid connection between coil and contact housing
- Compact size
- Custom design available,
 - coil voltage -IP67 washable
 - contact pressure -coil resistance
 - operate/release time
 - low power dissipation models

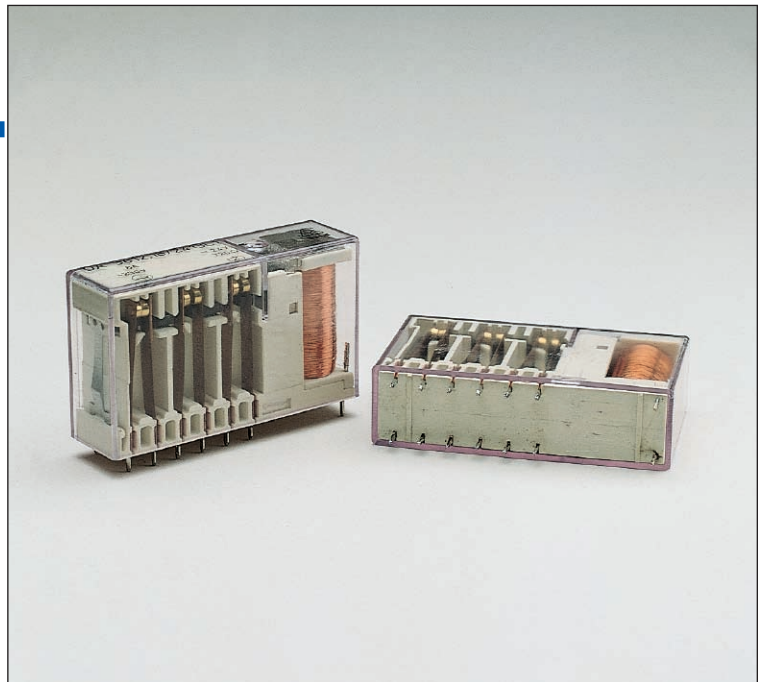

Technical Data

- | | |
|---|--|
| <ul style="list-style-type: none"> ■ Nominal Coil Voltage6, 12, 24, 48, 60, 110, DC ■ Coil Power Dissipation0.8 - 1.0 W ■ Max. Switching Voltage250V DC, 400V AC ■ Max. Switching Current8 A ■ Max. Switching Power—DC200W ■ Max. Switching Power—AC2000VA ■ Contact Switching Rate10 operations per second ■ Relay Operate Time20 ms ■ Relay Release Time6 ms ■ Operation Vibration0.35 mm Ampl. max @ 10...200Hz, 3g max ■ Protection RatingIP 40 | <ul style="list-style-type: none"> ■ Contact Arrangements2NO/4NC, 3NO/3NC, 4NO/2NC ■ Contact MaterialAgNi10+0.2µmAu, AgSnO₂ +0.2µmAu, AgNi10+5µmAu ■ Mechanical Life50x10⁶ operation cycles ■ Electrical LifeAgSnO₂ >3x10⁵, AgNi10 >2x10⁵ operation cycles @ 230V AC, 5A, cos φ=1
.....AgSnO₂ >1.5x10⁵, AgNi10 >10⁵ operation cycles @ 230V AC, 8A, cos φ=1 ■ Ambient Temperature-25...+85°C ■ Cover MaterialThermoplast ■ Weight38 g ■ More detailed data upon request |
|---|--|

Diagrams

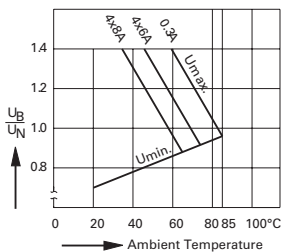

Relay operation voltage vs. ambient temperature

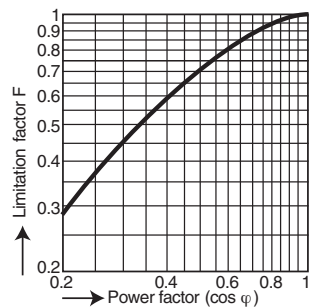

Limitation factor for inductive loads
Operations = Operations (ohmic) x limitation factor F

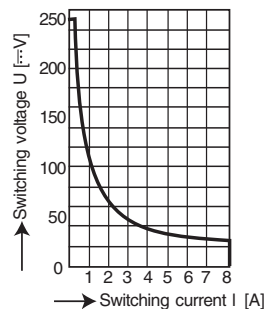

Maximum switching power curve
Safe disconnection, no remaining arc, max. 1 operation/sec.

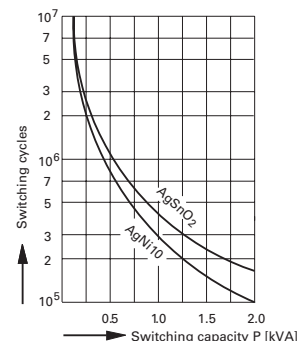

Mechanical life

Safety Relay 5612 Data

Relay Data				Ordering Information		
Rated Voltage	Voltage Range	Coil Resistance	2 NO/4 NC Type	Coil Resistance	3 NO/3 NC Type	4 NO/2 NC Type
6V	4.2 - 8.4V	36 Ω	56.OA12.0624□	45 Ω	56.OA12.0633□	56.OA12.0642□
12V	8.4 - 16.8V	145 Ω	56.OA12.1224□	180 Ω	56.OA12.1233□	56.OA12.1242□
24V	16.8 - 33.6V	600 Ω	56.OA12.2424□	720 Ω	56.OA12.2433□	56.OA12.2442□
48V	33.6 - 67.2V	2300 Ω	56.OA12.4824□	2880 Ω	56.OA12.4833□	56.OA12.4842□
60V	42.0 - 84.0V	3600 Ω	56.OA12.6024□	4500 Ω	56.OA12.6033□	56.OA12.6042□
110V	77.0 - 154.0V	12100 Ω	56.OA12.1124□	15125 Ω	56.OA12.1133□	56.OA12.1142□

Contact Material, Example: □ AgSnO₂+2μmAu

□ AgNi10+.2μmAu

□ AgNi10+5μmAu

Footprints

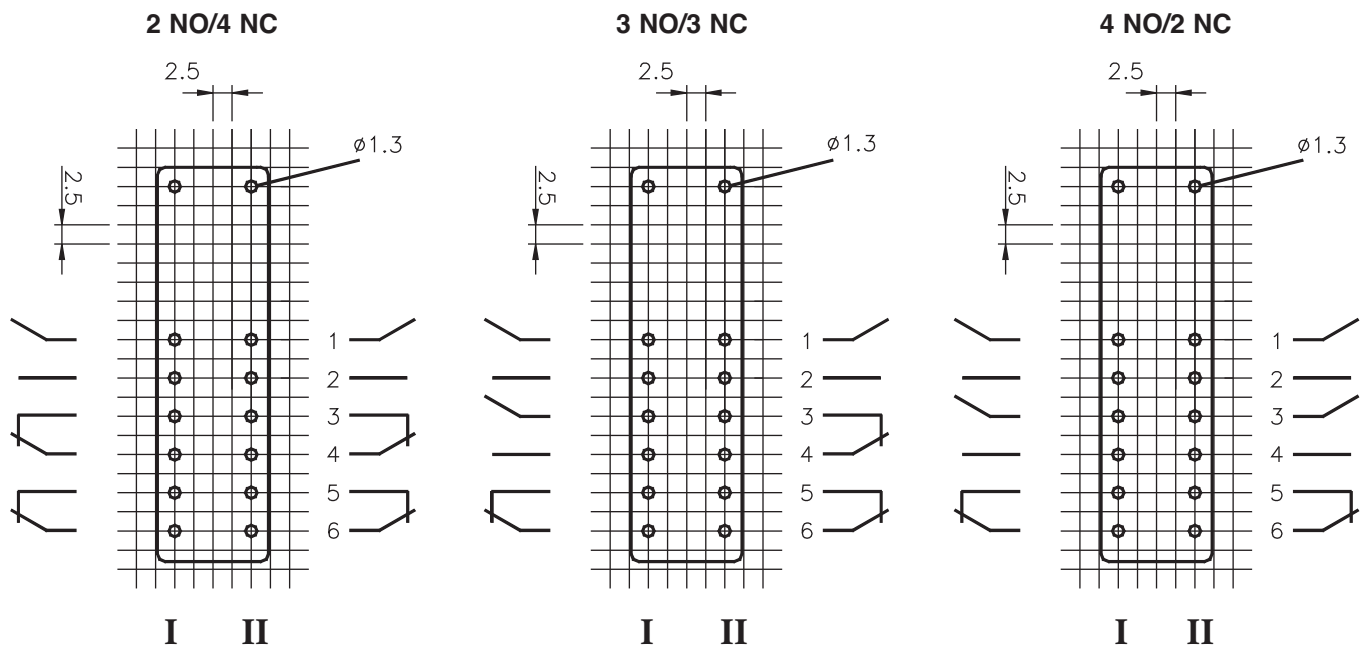

Dimensions

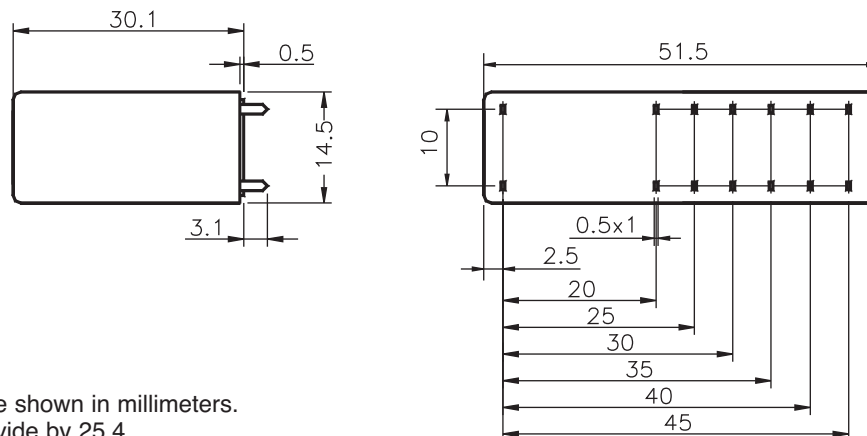

Note: All dimensions are shown in millimeters.
To convert to inches, divide by 25.4.

Safety Relay

OA 5601

Features

- 4 output contacts
- International approvals: TÜV, CSA, UL, cUL
- Quality control check for each safety relay
- Forced-guided contacts, all gold flash plated
- Contact gap > 0.5 mm throughout life of relay
- Various contact materials, mixed contact material optional
- High coil voltage range
- High switching voltage
- High breakdown voltage: contact/coil > 4 KV
- High creeping distance: contact/coil > 8 mm
- Crown contacts
- Solid connection between coil and contact housing
- Custom design available,
 - coil voltage
 - coil resistance,
 - contact pressure
 - operate/release time

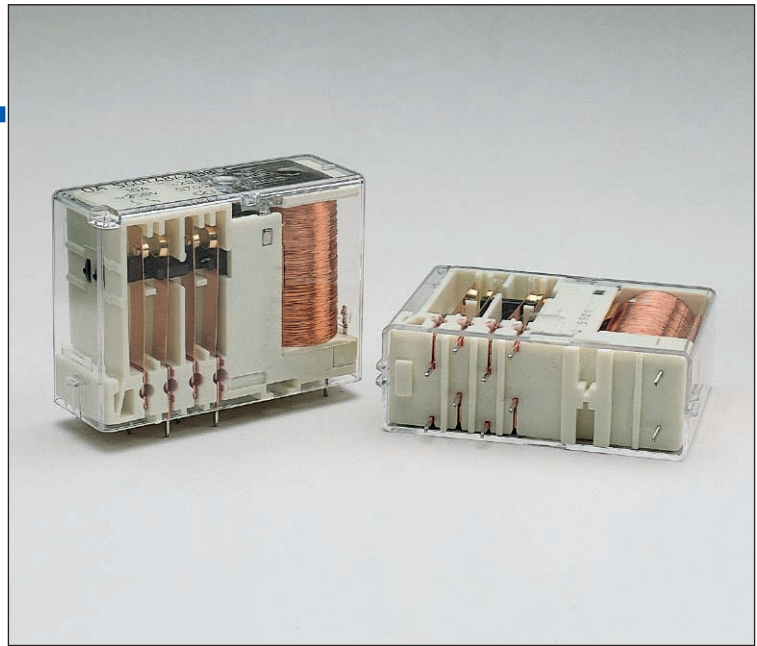

GERMANY



USA/CANADA
E146415



CANADA

Technical Data

- | | |
|---|---|
| <ul style="list-style-type: none"> ■ Nominal Coil Voltage.....6,12 ,24, 48, 60, 110, DC ■ Coil Power Dissipation.....0.75 W ■ Max. Switching Voltage.....250V DC, 400V AC ■ Max. Switching Current.....10 A ■ Max. Switching Power—DC240W ■ Max. Switching Power—AC2500VA ■ Contact Switching Rate10 operations per second ■ Relay Operate Time27 ms ■ Relay Release Time5 ms ■ Operation Vibration.....0.35 mm Ampl. max @ 10...55Hz ■ Contact Arrangements.....2NO/2NC, 3NO/1NC | <ul style="list-style-type: none"> ■ Contact Material.....
...AgSnO₂+0.2µmAu, AgNi10+0.2µmAu, AgNi10+5µmAu ■ Mechanical Life30x10⁶ operation cycles ■ Electrical Life.....AgSnO₂ >7x10⁵, AgNi10 >5x10⁵
.....operation cycles @ 230V AC, 5A, cos φ=1
.....AgSnO₂ >3x10⁵, AgNi10 >2x10⁵
.....operation cycles @ 230V AC, 10A, cos φ=1 ■ Ambient Temperature-25...+85°C ■ Protection RatingIP 40 ■ Cover Material.....Thermoplast ■ Weight.....75 g ■ More detailed data upon request |
|---|---|

Diagrams

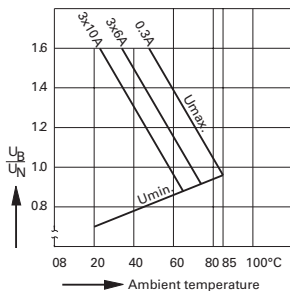

Relay operation voltage vs. ambient temperature

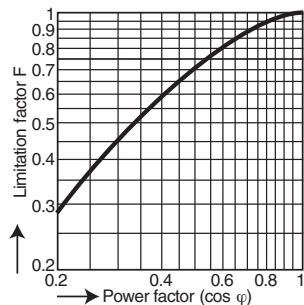

Operations =
Operations (ohmic) x limitation factor F

Limitation factor for inductive loads

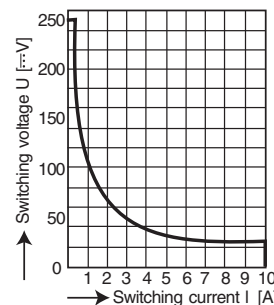

Safe disconnection, no remaining arc, max. 1 operation/sec.

Maximum switching power curve

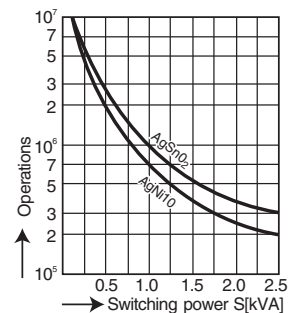

Mechanical life

Safety Relay 5601 Data

Relay Data			Ordering Information	
Rated Voltage	Voltage Range	Coil Resistance	2 NO/2 NC Type	3 NO/1 NC Type
6V	4.2 - 9.6V	48 Ω	56.OA01.0622□	56.OA01.0631□
12V	8.4 - 19.2V	192 Ω	56.OA01.1222□	56.OA01.1231□
24V	16.8 - 38.4V	770 Ω	56.OA01.2422□	56.OA01.2431□
48V	33.6 - 76.8V	2880 Ω	56.OA01.4822□	56.OA01.4831□
60V	42.0 - 96.0V	4880 Ω	56.OA01.6022□	56.OA01.6031□
110V	77.0 - 176.0V	16000 Ω	56.OA01.1122□	56.OA01.1131□

Contact Material, Example: □ AgSnO₂+2μmAu
 □ AgNi10+.2μmAu
 □ AgNi10+5μmAu

Footprints

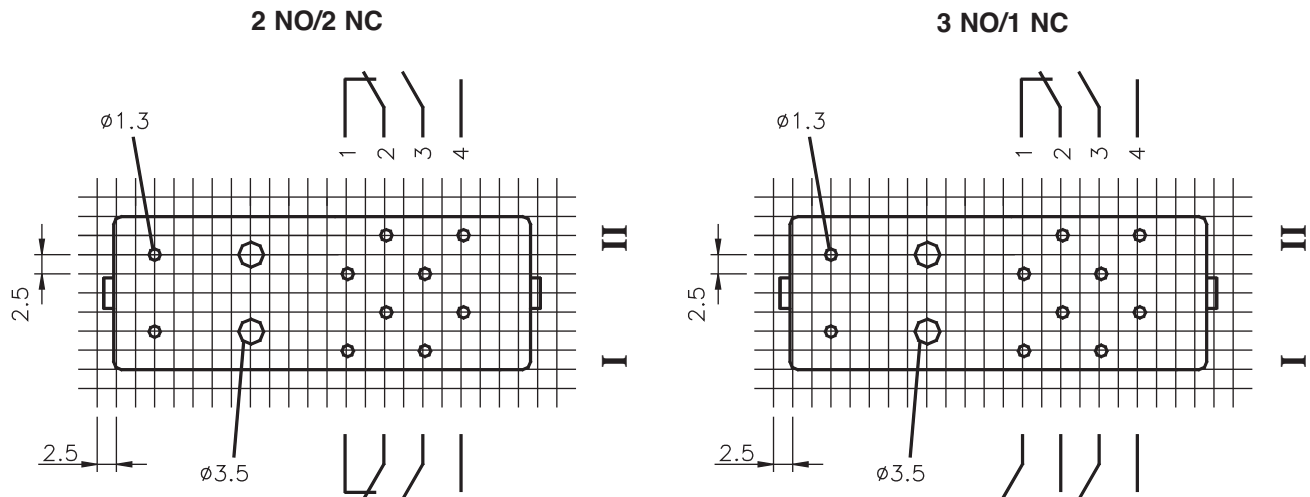

Dimensions

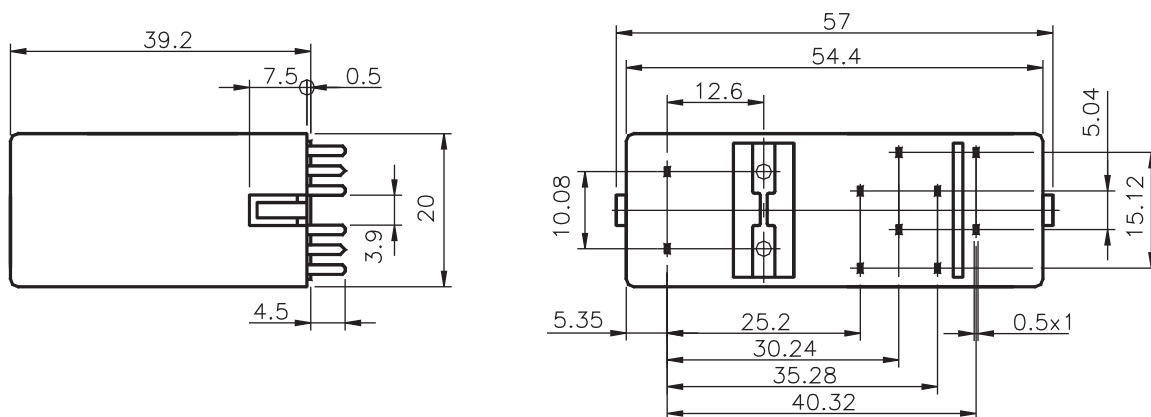

Note: All dimensions are shown in millimeters.
 To convert to inches, divide by 25.4.

Safety Relay OA 5602

Features

- 6 output contacts
- International approvals: TÜV, CSA, UL, cUL
- Quality control check for each safety relay
- Forced-guided contacts, all gold flash plated
- Contact gap > 0.5 mm throughout life of relay
- Various contact materials, mixed contact material optional
- High coil voltage range
- High switching voltage
- High breakdown voltage: contact/coil > 4 KV
- High creeping distance: contact/coil > 8 mm
- Crown contacts
- Solid connection between coil and contact housing
- Custom coil voltage available
- Custom design available,
 - coil voltage
 - coil resistance,
 - contact pressure
 - operate/release time

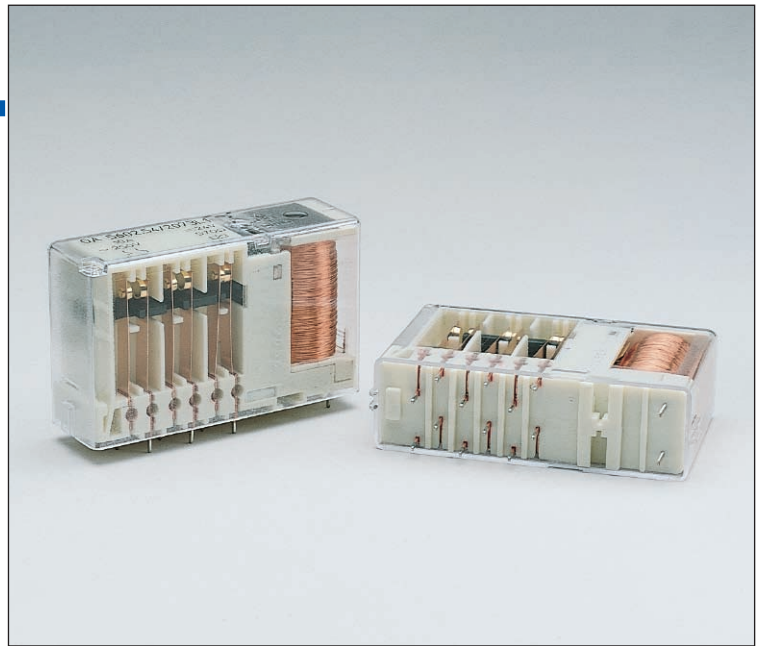

GERMANY



USA/CANADA
E146415



CANADA

Technical Data

- **Nominal Coil Voltage**6, 12, 24, 48, 60, 110, DC
- **Coil Power Dissipation**1.0 W
- **Max. Switching Voltage**.....250V DC, 400V AC
- **Max. Switching Current**10 A
- **Max. Switching Power—DC**240W
- **Max. Switching Power—AC**2500VA
- **Contact Switching Rate**10 operations per second
- **Relay Operate Time**27 ms
- **Relay Release Time**5 ms
- **Operation Vibration**0.35 mm Ampl. max @ 10...55Hz
- **Protection Rating**IP 40
- **Contact Arrangements**2NO/4NC, 3NO/3NC, 4NO/2NC
- **Contact Material**.....AgSnO₂+0.2μmAu, AgNi10+0.2μmAu, AgNi10+5μmAu
- **Mechanical Life**.....30x10⁶ Operation cycles
- **Electrical Life**.....AgSnO₂ >7x10⁵, AgNi10 >5x10⁵ operation cycles @ 230V AC, 5A, cos φ=1
.....AgSnO₂ >3x10⁵, AgNi10 >2x10⁵ operation cycles @ 230V AC, 10A, cos φ=1
- **Ambient Temperature**-25...+85°C
- **Cover Material**.....Thermoplast
- **Weight**.....85 g
- More detailed data upon request

Diagrams

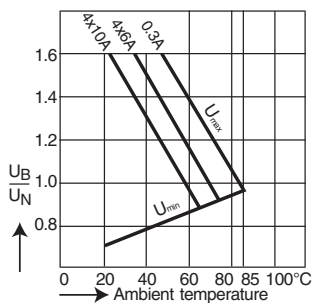

Relay operation voltage vs. ambient temperature

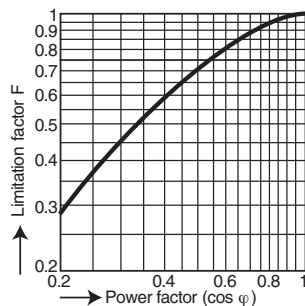

Limitation factor for inductive loads
Operations = Operations (ohmic) x limitation factor F

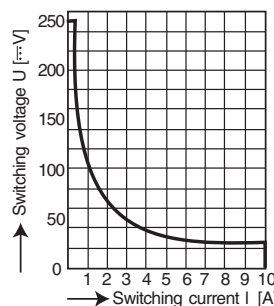

Maximum switching power curve
Safe disconnection, no remaining arc, max. 1 operation/sec.

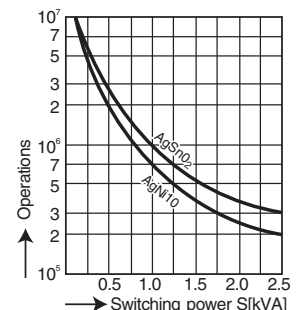

Mechanical life

Safety Relay 5602 Data

Relay Data			Ordering Information		
Rated Voltage	Voltage Range	Coil Resistance	2 NO/4 NC Type	3 NO/3 NC Type	4 NO/2 NC Type
6V	4.2 - 9.6V	35 Ω	56.OA02.0624□	56.OA02.0633□	56.OA02.0642□
12V	8.4 - 19.2V	140 Ω	56.OA02.1224□	56.OA02.1233□	56.OA02.1242□
24V	16.8 - 38.4V	570 Ω	56.OA02.2424□	56.OA02.2433□	56.OA02.2442□
48V	33.6 - 76.8V	2300 Ω	56.OA02.4824□	56.OA02.4833□	56.OA02.4842□
60V	42.0 - 96.0V	3600 Ω	56.OA02.6024□	56.OA02.6033□	56.OA02.6042□
110V	77.0 - 176.0V	12100 Ω	56.OA02.1124□	56.OA02.1133□	56.OA02.1142□

Contact Material, Example: □ AgSnO₂+2μmAu
 □ AgNi10+.2μmAu
 □ AgNi10+5μmAu

Footprints

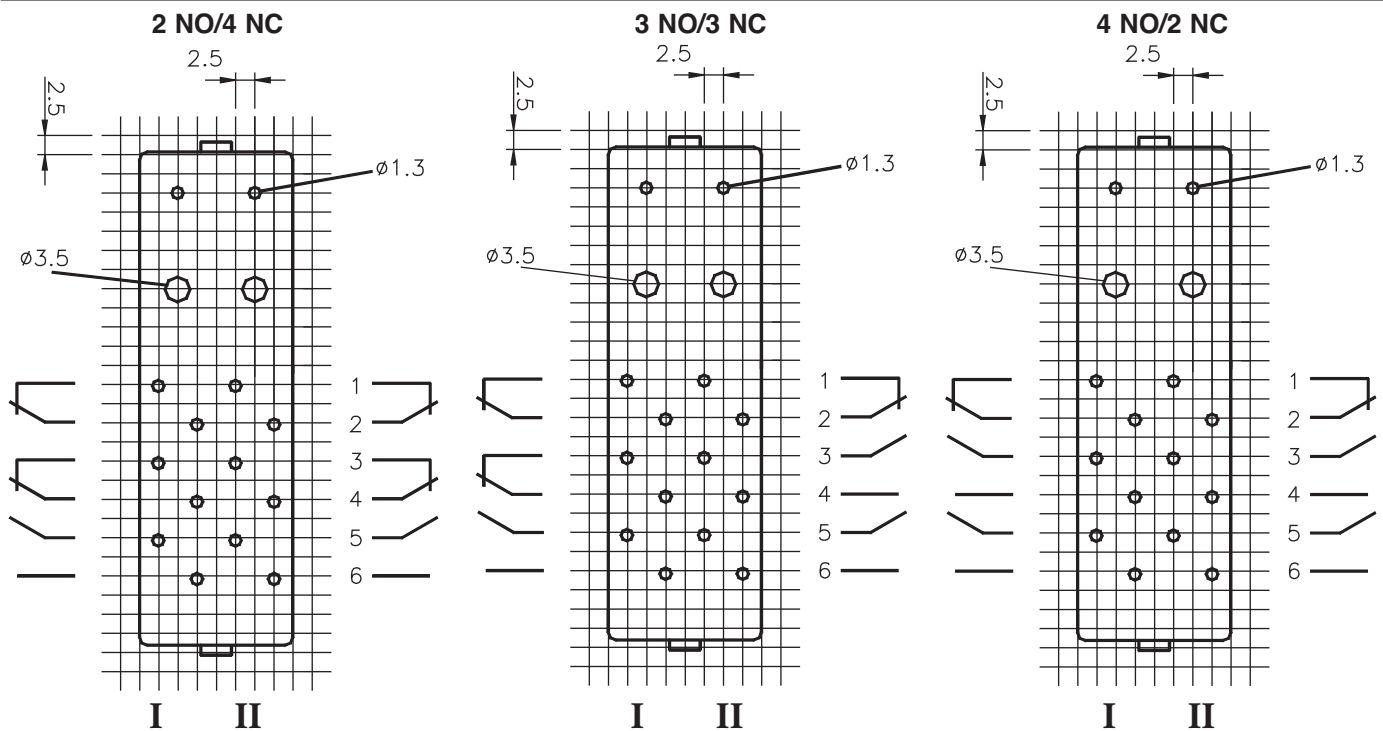

Dimensions

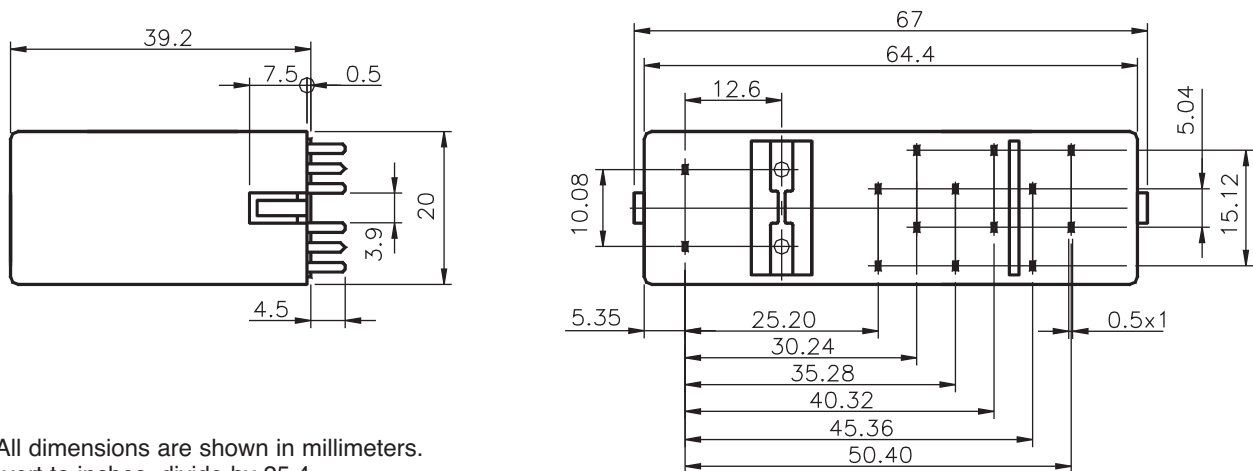

Note: All dimensions are shown in millimeters.
 To convert to inches, divide by 25.4.

Safety Relay

OA 5603

Features

- 8 output contacts
- International approvals: TÜV, UL, cUL, CSA
- Quality control check for each safety relay
- Forced-guided contacts, all gold flash plated
- Contact gap > 0.5 mm throughout life of relay
- Various contact materials, mixed contact material optional
- High coil voltage range
- High switching voltage
- High breakdown voltage: contact/coil > 4 KV
- High creeping distance: contact/coil > 8 mm
- Crown contacts
- Solid connection between coil and contact housing
- Custom design available,
 - coil voltage
 - coil resistance,
 - contact pressure
 - operate/release time

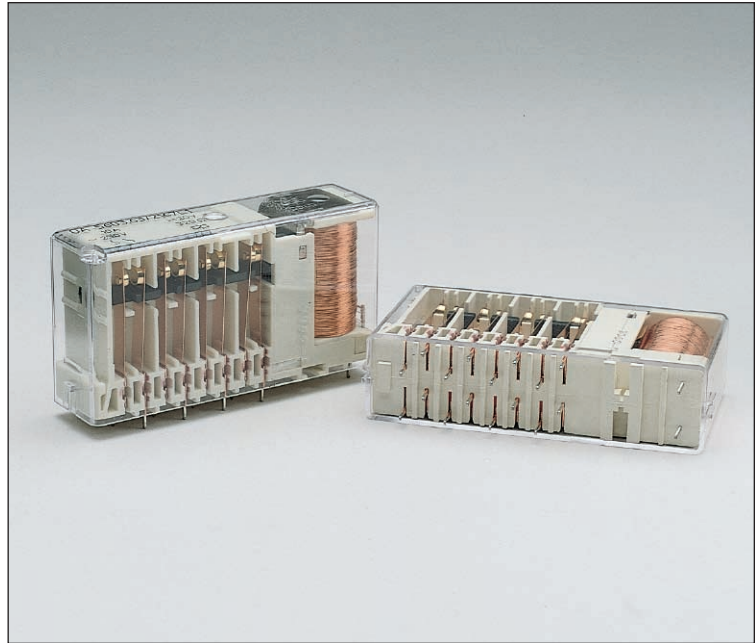

GERMANY



C US
USA/CANADA
E146415



CANADA

Technical Data

- **Nominal Coil Voltage** 6, 12, 24, 48, 60, 110, DC
- **Coil Power Dissipation**.....1.25 - 1.65 W
- **Max. Switching Voltage**.....250V DC, 400V AC
- **Max. Switching Current**10 A
- **Max. Switching Power—DC**240W
- **Max. Switching Power—AC**2500VA
- **Contact Switching Rate**10 operations per second
- **Relay Operate Time**27 ms
- **Relay Release Time**5 ms
- **Operation Vibration**.....0.35 mm Ampl. max
.....@ 10...55Hz
- **Protection Rating**IP 40
- **Contact Arrangements**.....
.....2NO/6NC, 3NO/5NC, 4NO/4NC, 5NO/3NC,
.....6NO/2NC, 7NO/1NC
- **Contact Material**.....
AgSnO₂+0.2μmAu , AgNi10+0.2μmAu , AgNi10+5μmAu
- **Mechanical Life**30x10⁶ Operation cycles
- **Electrical Life**.....AgSnO₂ >7x10⁵, AgNi10 >5x10⁵
.....operation cycles @ 230V AC, 5A, cos φ=1
.....AgSnO₂ >3x10⁵, AgNi10 >2x10⁵
.....operation cycles @ 230V AC, 10A, cos φ=1
- **Ambient Temperature**-25...+75°C
- **Cover Material**.....Thermoplast
- **Weight**.....95 g
- More detailed data upon request

Diagrams

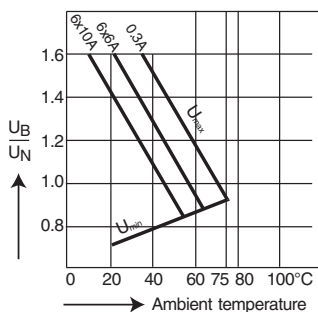

Relay operation voltage vs. ambient temperature

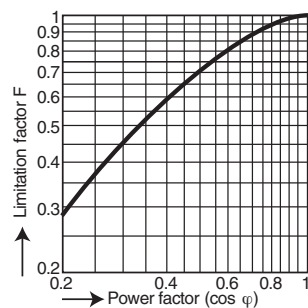

Limitation factor for inductive loads
Operations =
Operations (ohmic) x limitation factor F

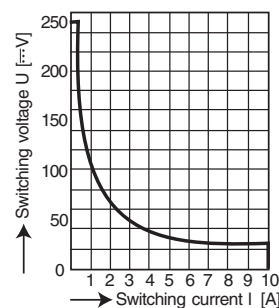

Safe disconnection, no remaining arc,
max. 1 operation/sec.

Maximum switching power curve

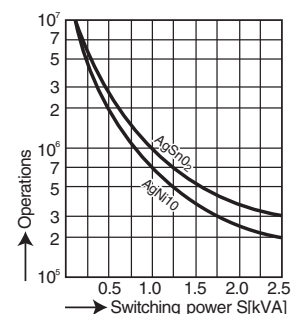

Mechanical life

Safety Relay 5603 Data

Relay Data

Ordering Information

Rated Voltage	Voltage Range	Coil Resistance	2 NO/6 NC Type	3 NO/5 NC Type	Coil Resistance	4 NO/4 NC Type	5 NO/3 NC Type	6 NO/2 NC Type	7 NO/1 NC Type
6V	4.2 - 9.6V	21 Ω	56.OA03.0626□	56.OA03.0635□	29 Ω	56.OA03.0644□	56.OA03.0653□	56.OA03.0662□	56.OA03.0671□
12V	8.4 - 19.2V	88 Ω	56.OA03.1226□	56.OA03.1235□	112 Ω	56.OA03.1244□	56.OA03.1253□	56.OA03.1262□	56.OA03.1271□
24V	16.8 - 38.4V	370 Ω	56.OA03.2426□	56.OA03.2435□	460 Ω	56.OA03.2444□	56.OA03.2453□	56.OA03.2462□	56.OA03.2471□
48V	33.6 - 76.8V	1400 Ω	56.OA03.4826□	56.OA03.4835□	1800 Ω	56.OA03.4844□	56.OA03.4853□	56.OA03.4862□	56.OA03.4871□
60V	42.0 - 96.0V	2230 Ω	56.OA03.6026□	56.OA03.6035□	2880 Ω	56.OA03.6044□	56.OA03.6053□	56.OA03.6062□	56.OA03.6071□
110V	77.0 - 176.0V	7150 Ω	56.OA03.1126□	56.OA03.1135□	9500 Ω	56.OA03.1144□	56.OA03.1153□	56.OA03.1162□	56.OA03.1171□

Contact Material, Example: **C** AgSnO₂+2μmAu

N AgNi10+.2μmAu

S AgNi10+5μmAu

Footprints

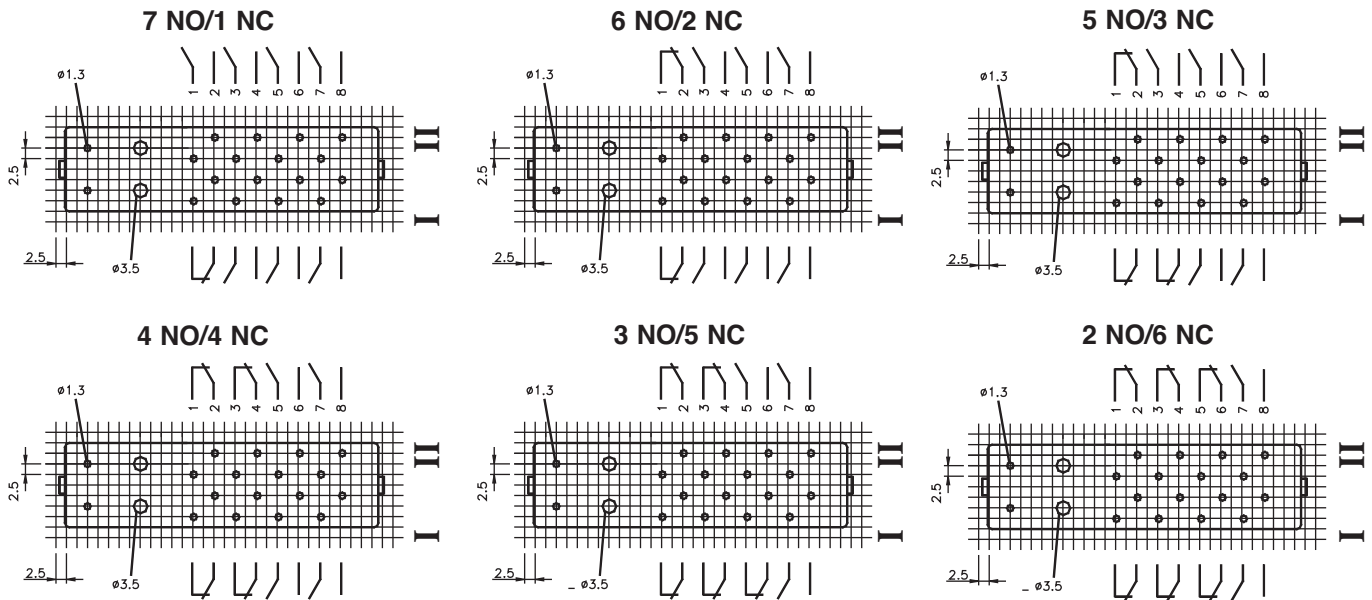

Dimensions

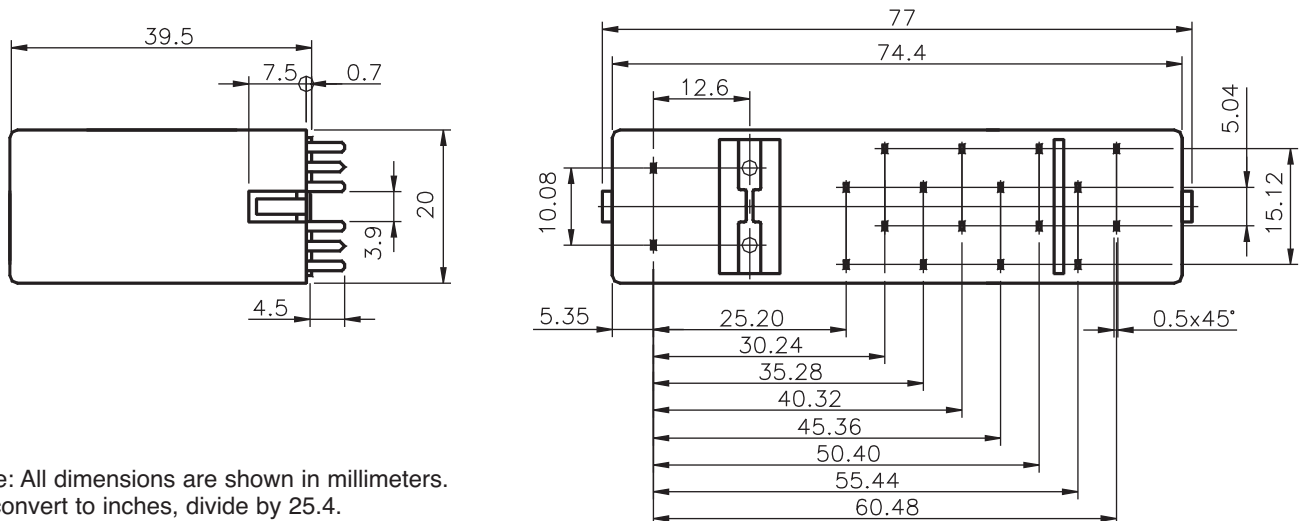

Note: All dimensions are shown in millimeters. To convert to inches, divide by 25.4.

SAFETY RELAY MODULES

SAFETY RELAY MODULES

8 Amp Contacts, 35 or 32mm DIN Rail

Altech Safety Relay Modules utilize Relays with Force-Guided-Contacts that meet or exceed international standards, TÜV and UL. They are designed to protect man and machine as specified in OSHA FR1910 Regulations, a mandatory requirement of the European Machinery Directive EMD 89.392 EEC. The Safety Relays are used in Safety Devices such as Emergency Stop Modules, Safety Gate Monitors, 2-Hand Safety Modules, etc.

This series of Safety Relay Modules are Double Pole, Double Throw configurations, and are available as 1, 2, 4, 8 and 16 isolated channels and 8 and 16 bussed channels with 12 or 24 VDC coils. Isolated channels allow control of each relay by a different logic system, if necessary. There are two inputs for each relay coil per channel. Bussed channels allow high density packaging with a common input for all relays. Safety Relay Modules may be ordered with three different types of relay contact material, depending on the actual load current.

- Screw-Cage Clamp Connection
- LED Coil Voltage Indicator
- Reverse DC Polarity LED Protection
- Surge Suppression With DC Coils
- Industry Standard Relays
- DIN Rail Mount, Panel Mount Available

Isolated Channel Double Pole Double Throw

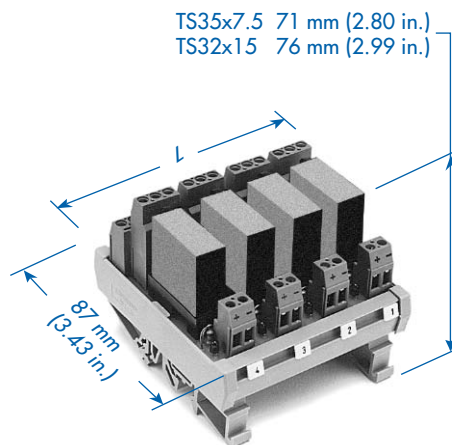

Bussed Channel Double Pole Double Throw

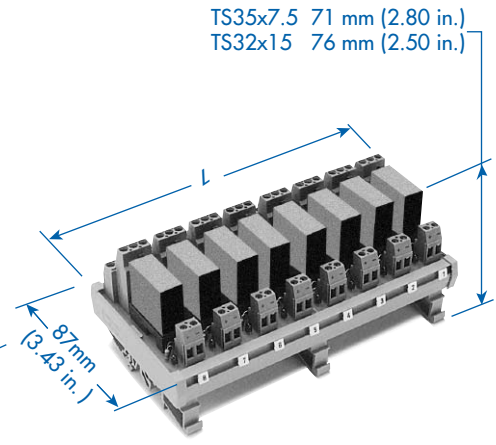

Contact Material:
AgSnO₂+0.2µmAu
Contact Ratings:
8A(2x5A) 110DC, 250VAC

Contact Material:
AgNi10+0.2µmAu
Contact Ratings:
8A(2x5A) 110DC, 250VAC

Contact Material:
AgNi10+5µmAu
Contact Ratings:
8A(2x5A) 110DC, 250VAC

Isolated Channels (No Bus)	Length (L) mm (in.)	Type/Cat. No.	Type/ Cat. No.	Type/Cat. No.	
1 Channel, Coil Voltage	21 (0.83)				
		12V	8949.2C	8949.2N	8949.2S
		24V	8951.2C	8951.2N	8951.2S
2 Channel, Coil Voltage	40 (1.57)				
		12V	8949.3C	8949.3N	8949.3S
		24V	8951.3C	8951.3N	8951.3S
4 Channel, Coil Voltage	79 (3.11)				
		12V	8955.2C	8955.2N	8955.2S
		24V	8956.2C	8956.2N	8956.2S
8 Channel, Coil Voltage	157 (6.18)				
		12V	8955.3C	8955.3N	8955.3S
		24V	8956.3C	8956.3N	8956.3S
16 Channel, Coil Voltage	311 (12.24)				
		12V	8963.2C	8963.2N	8963.2S
		24V	8972.2C	8972.2N	8972.2S
Bussed Channels	Length (L) mm (in.)	Type/Cat. No.	Type/ Cat. No.	Type/Cat. No.	
8 Channel, Bussed DC+	125 (4.92)				
		12V	8923.2C	8923.2N	8923.2S
		24V	8924.2C	8924.2N	8924.2S
8 Channel, Bussed DC-	125 (4.92)				
		12V	8923.3C	8923.3N	8923.3S
		24V	8924.4C	8924.4N	8924.4S
16 Channel, Bussed DC+	248 (9.76)				
		12V	8926.2C	8926.2N	8926.2S
		24V	8926.3C	8926.3N	8926.3S
16 Channel, Bussed DC-	248 (9.76)				
		12V	8927.2C	8927.2N	8927.2S
		24V	8927.3C	8927.3N	8927.3S

Isolated Channel, DPDT

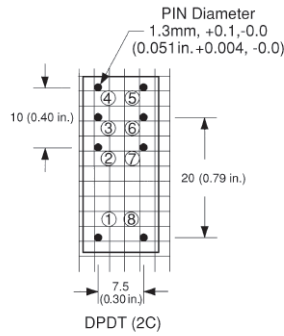

Bottom View, Relay Pinouts, Grid 2.54mm (0.1 in.)

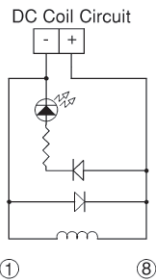

① ⑧

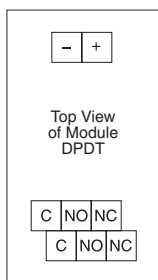

Top View of Module DPDT

Bussed Channel, DPDT

Relay Pinout

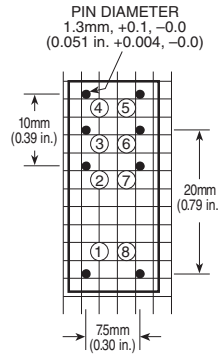

Coil Circuits

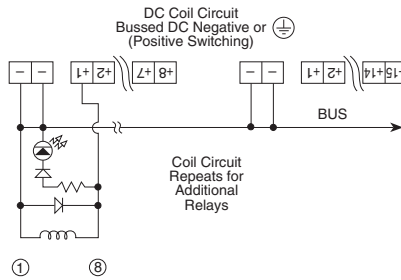

① ⑧

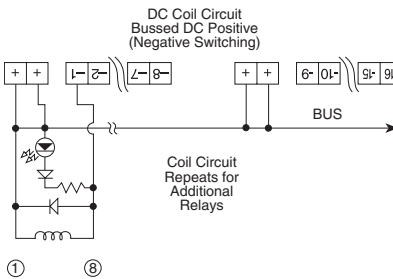

① ⑧

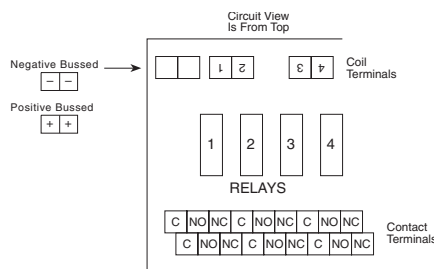

Circuit View Is From Top

Negative Bussed
- -

Positive Bussed
+ +

Coil Terminals

RELAYS

Contact Terminals

Contact Circuits

For Both Isolated and Bussed Channels

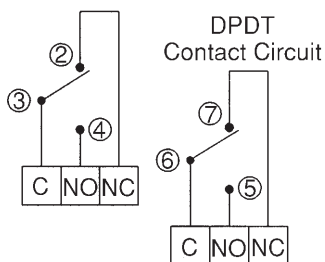

DPDT Contact Circuit

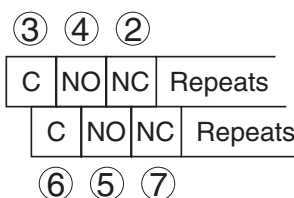

Relay Specifications

-Normal Coil Voltage: 12,24 VDC
 -Coil Power Dissipation: 0.7W
 -Max. Switching Voltage: 110VDC, 250VAC
 -Max. Switching Current: 8A(2x5A simultaneous)

-Max. Switching Power:
 DC: 200W (2x160W simultaneous)
 AC: 2000VA (2x1250VA simultaneous)

-Contact Switching Rate: 10 operations/ sec.
 -Relay Operate Time: 15 ms
 -Relay Release Time: 12 ms
 -Contact Arrangements: DPDT, 2 FORM C

-Contact Material:
 Standard: AgNi10+0.2µmAu
 Optional: AgSnO₂+0.2µmAu
 AgNi10+5µmAu

-Mechanical Life: 50x10⁶ operation cycles
 -Ambient Temperature: -40° + 60°C
 -Cover Material: Polyamide 6
 -Weight: 15g

Coil Specifications

Rated Voltage	Voltage Range	Coil Resistance
12VDC	9.6V-19.2V	210Ω ± 15%
24VDC	19.2V-38.4V	820Ω ± 15%

SAFETY RELAY MODULES

SAFETY RELAY MODULES 4 Pole Relays, 8 or 10 Amps

Altech Safety Relay Modules utilize Relays with Force-Guided-Contacts that meet or exceed international standards, TÜV and UL. They are designed to protect man and machine as specified in OSHA CFR1910 Regulations, which is a mandatory requirement of the European Machinery Directive EMD 89.392 EEC.

Altech Safety Relays are electro-mechanical relays that are mechanically linked together, causing all contacts to move together when the coil is energized. Force-Guided-contacts are also known as positive-guided-contacts, captive contacts or locked contacts. In addition, our Safety Relays have Crown Contacts which provide two locations per contacts to improve switching conditions. The Safety Relays are used in Safety Devices such as Emergency Stop Modules, Safety Gate Monitors, 2-Hand Safety Modules, Safety Light Curtains, etc.

This series of Safety Relay Modules consist of 4 pole relays with two choices of configurations (2NO/2NC or 3NO/1NC), with 8 or 10 Amp contacts, and are available as 1, 2, and 4 isolated channels with 12, or 24 VDC coils. Isolated channels allows control of each relay by a different logic system, if necessary. There are two inputs for each relay coil per channel. Safety Relay Modules may be ordered with three different types of relay contact material, depending on the actual load current. The part numbers shown in this data sheet are for our standard contact material, which is $\text{AgSnO}_2 + 0.2\mu\text{mAu}$.

- Screw-Cage clamp Connections
- LED Coil Voltage Indicator
- Reverse DC Polarity LED Protection
- Surge Suppression With DC Coil
- Din Rail Mount, Panel Mount Available

4 Pole, 8 Amp

4 Pole, 10 A

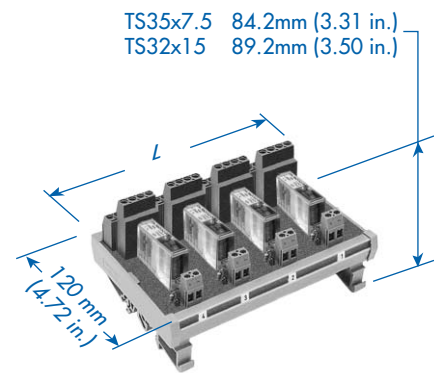
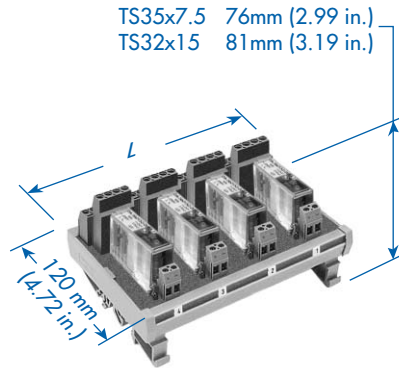

Ordering Information		4 Pole, 8 Amp		4 Pole, 10 A	
Length (L) mm (in.)	Type/ Cat. No.	Type/ Cat. No.	Type/ Cat. No.	Type/ Cat. No.	Type/ Cat. No.
1 Channel, Coil Voltage 12V 24V	2N.O + 2N.C	156.0A11.1222C	156.0A11.1231C	156.0A01.1222C	156.0A01.1231C
	3N.O + 1N.C	156.0A11.2422C	156.0A11.2431C	156.0A01.2422C	156.0A01.2431C
2 Channel, Coil Voltage 12V 24V	2N.O + 2N.C	256.0A11.1222C	256.0A11.1231C	256.0A01.1222C	256.0A01.1231C
	3N.O + 1N.C	256.0A11.2422C	256.0A11.2431C	256.0A01.2422C	256.0A01.2431C
4 Channel, Coil Voltage 12V 24V	2N.O + 2N.C	456.0A11.1222C	456.0A11.1231C	456.0A01.1222C	456.0A01.1231C
	3N.O + 1N.C	456.0A11.2422C	456.0A11.2431C	456.0A01.2422C	456.0A01.2431C

* Note: Additional relay contact materials are available upon request. Please contact Altech for additional information.

4 Pole, 8 Amps

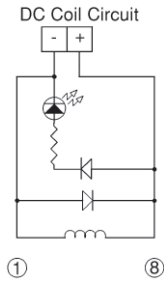

DC Coil Circuits

4 Pole, 10 Amps

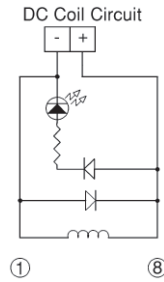

Contact Circuits

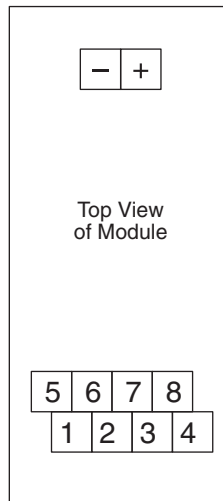
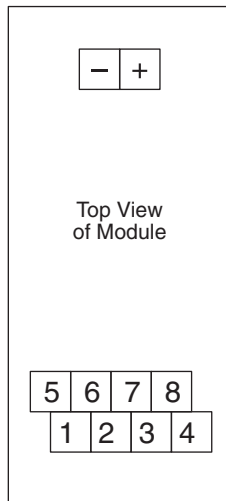

Relay Configurations

2 N.O + 2 N.C
 NO Pin (1,2), (5,6)
 NC Pin (3,4), (7,8)

3 N.O + 1 N.C
 NO Pin (1,2), (5,6), (7,8)
 NC Pin (3,4)

Relay Configurations

2 N.O + 2 N.C
 NO Pin (3,4), (7,8)
 NC Pin (1,2), (5,6)

3 N.O + 1 N.C
 NO Pin (3,4), (5,6), (7,8)
 NC Pin (1,2)

Relay Specifications - 8 Amps

-Normal Coil Voltage: 12,24 VDC
 -Coil Power Dissipation: 0.6W
 -Max. Switching Voltage: 250VDC, 400VAC
 -Max. Switching Current: 8A

-Max. Switching Power:
 DC: 200W
 AC: 2000VA

-Contact Switching Rate: 10 operations/ sec.
 -Relay Operate Time: 20 ms
 -Relay Release Time: 6 ms
 -Contact Arrangements: 2NO/2NC, 3NO/1NC

-Contact Material:
 Standard: AgSnO₂+0.2μmAu
 Optional: AgNi10+0.2μmAu
 AgNi10+5μmAu

-Mechanical Life: 50x10⁶ operation cycles
 -Ambient Temperature: -25° + 85°C
 -Cover Material: Thermoplast
 -Weight: 35g

Coil Specifications

Rated Voltage	Voltage Range	Coil Resistance
12VDC	8.4V-16.8V	240Ω ± 15%
24VDC	16.8V-33.6V	960Ω ± 15%

Relay Specifications - 10 Amps

-Normal Coil Voltage: 12,24 VDC
 -Coil Power Dissipation: 0.75W
 -Max. Switching Voltage: 250VDC, 400VAC
 -Max. Switching Current: 10A

-Max. Switching Power:
 DC: 240W
 AC: 2500VA

-Contact Switching Rate: 10 operations/ sec.
 -Relay Operate Time: 27 ms
 -Relay Release Time: 5 ms
 -Contact Arrangements: 2NO/2NC, 3NO/1NC

-Contact Material:
 Standard: AgSnO₂+0.2μmAu
 Optional: AgNi10+0.2μmAu
 AgNi10+5μmAu

-Mechanical Life: 30x10⁶ operation cycles
 -Ambient Temperature: -25° + 80°C
 -Cover Material: Thermoplast
 -Weight: 75g

Coil Specifications

Rated Voltage	Voltage Range	Coil Resistance
12VDC	8.4V-19.2V	192Ω ± 15%
24VDC	16.8V-38.4V	770Ω ± 15%

SAFETY RELAY MODULES

SAFETY RELAY MODULES 6 Pole Relays, 8 or 10 Amps

Altech Safety Relay Modules utilize Relays with Force-Guided-Contacts that meet or exceed international standards, TÜV and UL. They are designed to protect man and machine as specified in OSHA CFR1910 Regulations, which is a mandatory requirement of the European Machinery Directive EMD 89.392 EEC.

Altech Safety Relays are electro-mechanical relays that are mechanically linked together, causing all contacts to move together when the coil is energized. Force-Guided-contacts are also known as positive-guided-contacts, captive contacts or locked contacts. In addition, our Safety Relays have Crown Contacts which provides two locations per contacts to improve switching conditions. The Safety Relays are used in Safety Devices such as Emergency Stop Modules, Safety Gate Monitors, 2-Hand Safety Modules, Safety Light Curtains, etc.

This series of Safety Relay Modules consist of 6 pole relays with three configuration choices (2NO+4NC, 3NO+3NC, 4NO+2NC), 8 or 10 Amp contacts and either 1, 2 and 4 isolated channels with 12 or 24 VDC coils. Isolated channels allow control of each relay by a different logic system, if necessary. There are two inputs for each relay coil channel. Modules can be ordered with three contact materials, dependent upon the actual current load. The standard contact material is $\text{AgSnO}_2 + 0.2\mu\text{mAu}$.

- Screw-Cage clamp Connections
- LED Coil Voltage Indicator
- Reverse DC Polarity LED Protection
- Surge Suppression With DC Coil
- Din Rail Mount, Panel Mount Available

6 Pole, 8 Amps

6 Pole, 10 Amps

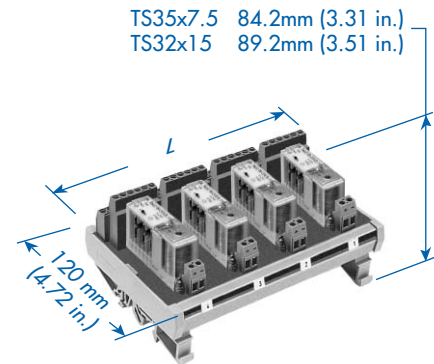
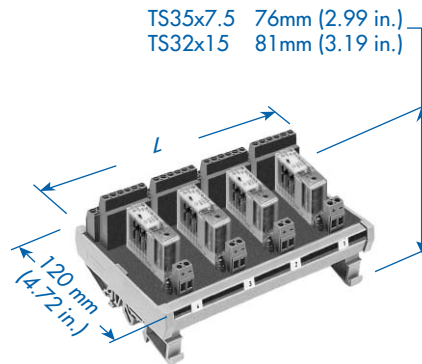

Contact Material*:

$\text{AgSnO}_2 + 0.2\mu\text{mAu}$

Contact Ratings:

8A(2x5A) 250VDC, 400VAC

Contacts:

2N.O + 4N.C

3N.O + 3N.C

4N.O + 2N.C

Contact Material*:

$\text{AgSnO}_2 + 0.2\mu\text{mAu}$

Contact Ratings:

10A(2x5A) 250VDC, 400VAC

Contacts:

2N.O + 4N.C

3N.O + 3N.C

4N.O + 2N.C

Ordering Information	Length (L) mm (in.)	Contact Material*: $\text{AgSnO}_2 + 0.2\mu\text{mAu}$ Contact Ratings: 8A(2x5A) 250VDC, 400VAC			Contact Material*: $\text{AgSnO}_2 + 0.2\mu\text{mAu}$ Contact Ratings: 10A(2x5A) 250VDC, 400VAC		
		Type/ Cat. No.	Type/ Cat. No.	Type/ Cat. No.	Type/ Cat. No.	Type/ Cat. No.	Type/ Cat. No.
1 Channel, Coil Voltage 12V 24V	46.45 (1.83)	156.0A12.1224C	156.0A12.1233C	156.0A12.1242C	156.0A02.1224C	156.0A02.1233C	156.0A02.1242C
		156.0A12.2424C	156.0A12.2433C	156.0A12.2442C	156.0A12.2424C	156.0A02.2433C	156.0A02.2442C
2 Channel, Coil Voltage 12V 24V	90.90 (3.58)	256.0A12.1224C	256.0A12.1233C	256.0A12.1242C	256.0A02.1224C	256.0A02.1233C	256.0A02.1242C
		256.0A12.2424C	256.0A12.2433C	256.0A12.2442C	256.0A12.2424C	256.0A02.2433C	256.0A02.2442C
4 Channel, Coil Voltage 12V 24V	179.80 (7.08)	456.0A12.1224C	456.0A12.1233C	456.0A12.1242C	456.0A02.1224C	456.0A02.1233C	456.0A02.1242C
		456.0A12.2424C	456.0A12.2433C	456.0A12.2442C	456.0A12.2424C	456.0A02.2433C	456.0A02.2442C

* Note: Additional relay contact materials are available upon request. Please contact Altech for additional information.

6 Pole, 8 Amps

6 Pole, 10 Amps

DC Coil Circuits

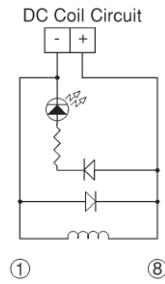
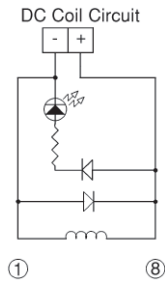

Contact Circuits

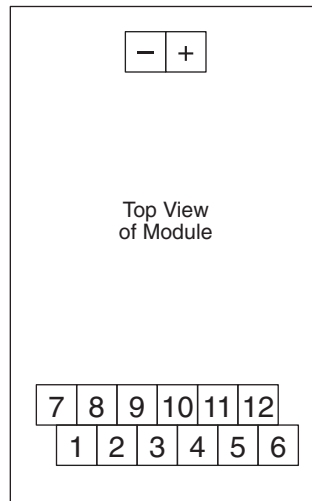
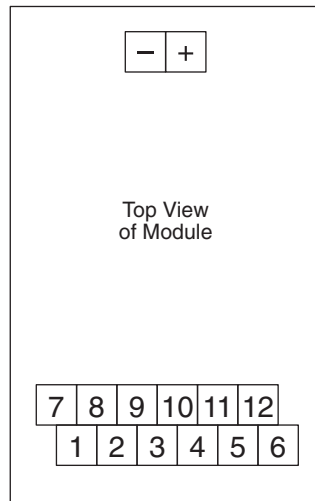

Relay Configurations

2N.O + 4N.C
 NO Pin (1,2), (7,8)
 NC Pin (3,4), (5,6), (9,10), (11,12)

3N.O + 3N.C
 NO Pin (1,2), (7,8), (9,10)
 NC Pin (3,4), (5,6), (11,12)

4N.O + 2N.C
 NO Pin (1,2), (3,4), (7,8), (9,10)
 NC Pin (5,6), (11,12)

Relay Configurations

2N.O + 4N.C
 NO Pin (5,6), (11,12)
 NC Pin (1,2), (3,4), (7,8), (9,10)

3N.O + 3N.C
 NO Pin (3,4), (5,6), (11,12)
 NC Pin (1,2), (7,8), (9,10)

4N.O + 2N.C
 NO Pin (3,4), (5,6), (9,10), (11,12)
 NC Pin (1,2), (7,8)

Relay Specifications - 8 Amps

-Normal Coil Voltage: 12,24 VDC
 -Coil Power Dissipation: 0.8-1.0 W
 -Max. Switching Voltage: 250VDC, 400VAC
 -Max. Switching Current: 8A

-Max. Switching Power
 DC 200W (2x160W simultaneous)
 AC 2000VA (2x1250VA simultaneous)

-Contact Switching Rate: 10 operations/ sec.
 -Relay Operate Time 20 ms
 -Relay Release Time 6 ms
 -Contact Arrangements 2NO/4NC, 3NO/3NC, 4NO/2NC

-Contact Material:
 Standard AgSnO₂+0.2µmAu
 Optional AgNi10+0.2µmAu
 AgNi10+5µmAu

-Mechanical Life: 50x10⁶ operation cycles
 -Ambient Temperature: -25° + 85°C
 -Cover Material: Thermoplast
 -Weight: 38g

Coil Specifications

Rated Voltage	Voltage Range	Coil Resistance
12VDC	8.4V-16.8V	145Ω ± 15%
24VDC	16.8V-33.6V	600Ω ± 15%

Relay Specifications - 10 Amps

-Normal Coil Voltage: 12,24 VDC
 -Coil Power Dissipation: 1.0 W
 -Max. Switching Voltage: 250VDC, 400VAC
 -Max. Switching Current: 10A

-Max. Switching Power
 DC 240W
 AC 2500VA

-Contact Switching Rate: 10 operations/ sec.
 -Relay Operate Time 27 ms
 -Relay Release Time 5 ms
 -Contact Arrangements 2NO/4NC, 3NO/3NC, 4NO/2NC

-Contact Material:
 Standard AgSnO₂+0.2µmAu
 Optional AgNi10+0.2µmAu
 AgNi10+5µmAu

-Mechanical Life: 30x10⁶ operation cycles
 -Ambient Temperature: -25° + 80°C
 -Cover Material: Thermoplast
 -Weight: 85g

Coil Specifications

Rated Voltage	Voltage Range	Coil Resistance
12VDC	8.4V-19.2V	140Ω ± 15%
24VDC	16.8V-38.4V	570Ω ± 15%

Relay Terminology

Ambient Temperature: The temperature of the surrounding medium that comes in contact with the device/ equipment.

Breakdown Voltage: The minimum root-mean-square (rms) value of a sinusoidal voltage that results in sparkover.

Coil, relay: One or more windings on a common form.

Coil Power Dissipation: The amount of electric power consumed by a winding. For the most practical purpose, this equals the I^2R loss.

Coil Resistance: The total terminal-to-terminal resistance of a coil at a specified temperature.

Contact Gap: The final length of the isolating distance between mating contacts when the contacts are open.

Contact Arrangement: The combination of contact forms that make up the entire relay switching structure.

Contact Housing: The part that provides means for mounting fixed contacts on a supporting structure.

Contact Material: Substance or combination of substances used as constituents in the manufacture of the contacts.

AgSnO₂ + 0.2μmAu: Silver-Tin Dioxide with a 0.2μ layer of gold. Medium to high current applications for resistive, capacitive and particular inductive loads, 100mA-10A.

AgNi10+ 0.2μmAu: Silver-Nickel 10 with a 0.2μ layer of gold. Medium to high current applications, 15mA-10A.

AgNi10+ 5μmAu: Silver-Nickel 10 with a 5μ layer of gold. Low current applications only, where switching of very low current is crucial; 1mA-300mA, 100mV-60V.

Contact Pressure: Force exerted by one contact against the mating contact of a relay.

Contact Switching Rate: The velocity at which contact switching occurs, e.g., 10 switching operations per second.

Corrosion: The deterioration of a substance, usually a metal, because of a reaction with its environment.

Cover Material: Substance or combination of substances used as constituents in the manufacture of a protective covering used to enclose equipment.

Creeping Distance: The shortest distance between two conducting parts measured along the surface or joints of the insulating material between them.

Safety Relay Selection Material Table

Material	Characteristics	Applications	Range
AgSnO ₂ + 0.2μmAu C	very low welding tendency highest burn-up resistivity very good arc suppression	special for switching, inductive loads	100mA - 10A
AgNi10 + 0.2μmAu N	low welding tendency high burn-up resistivity good arc suppression	circuits with medium to high switching current, DC current circuits	15mA - 10A
AgNi10 + 5μmAu S	higher welding tendency low burn-up resistivity low contact resistance	where very low to medium switching current and voltage is mandatory	1mA - 300mA

Crown Contacts: Improved contact form to enforce high contact stress on at least two spots on the contact to penetrate any built-up contamination; to maintain low contact resistance throughout the life of a relay; and to increase the value of switchable output voltage. Supports low current to high power applications.

Custom Design: Special design to meet customer requirements regarding coil voltage, coil resistance, contact pressure, and relay operate/release time. Possible alteration of max. 3 specifications from the original standard value while the remaining 1 is retained at its original value.

Graphic Symbols

Contact Name	Short Form	DIN / IEC Symbol	UL / CSA Symbol
Normally Open	NO, Form A		
Normally Closed	NC, Form B		
Changeover	CO, Form C, SPDT		

Forced-Guided Contacts: Electro-mechanical relay contacts that are mechanically linked together, so that when the relay coil is energized or de-energized, all of the linked contacts move together. If one set of contacts in the relay becomes immobilized, no other contact of the same relay will be able to move. An open-contact gap > 0.5 mm (0.02 in.) is maintained during life of the relay, even with malfunction, and at 1.6 x Nominal Voltage. Forced-Guided contacts are also known as captive contacts, positive-guided contacts, or locked contacts. They are used in Safety Relays.

Relay Terminology

Forced-Guided versus Standard Relay Contacts

Forced-Guided Relay Contacts

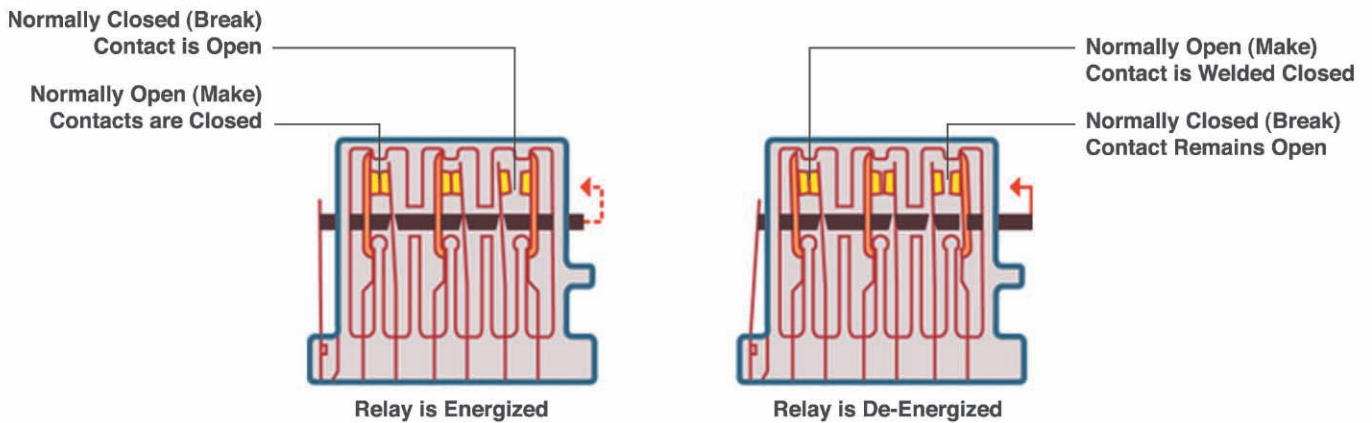

Standard Relay Contacts

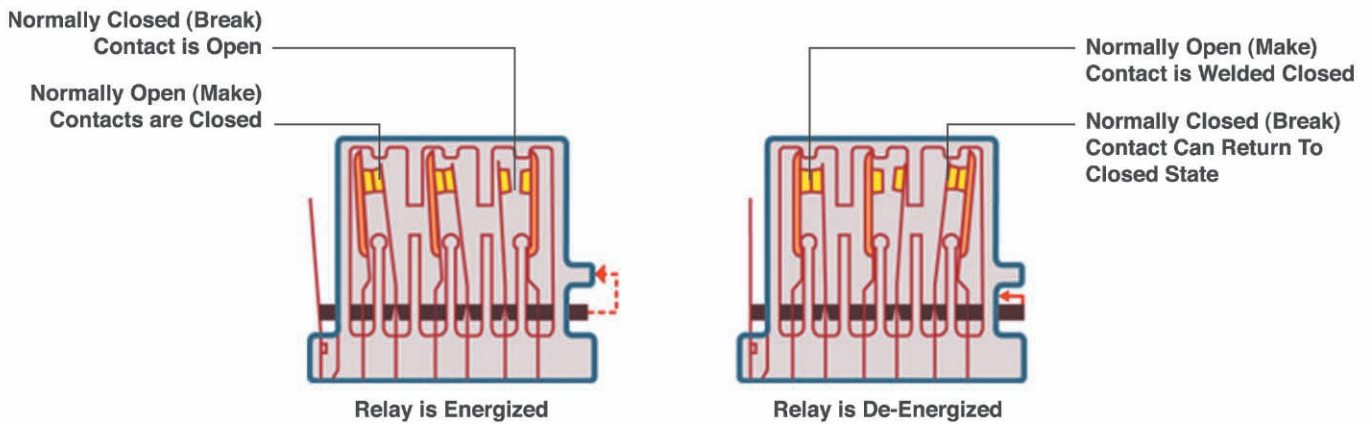

Relay Terminology

Flash-Plated: Thin gold coating of the relay contacts to prevent corrosion during shelf-life (long-time storage).

Mechanical Life: Number of expected operation cycles of the relay contacts.

Mixed Contact Material: Pertaining to a safety relay on which each single contact can be made of different material, e.g., 6 pole safety relay: 4 n/o contacts made of $\text{AgSnO}_2 + 0.2\mu\text{mAu}$ and 2 n/c contacts made of $\text{AgNi } 10 + 5\mu\text{mAu}$.

Normally Closed Contact (NC): A relay contact pair that is closed when the coil is not energized.

Normally Open Contact (NO): A relay contact pair that is open when the coil is not energized.

Nominal Coil Voltage: The voltage by which the coil is designated and to which certain operating characteristics of the relay are related.

Operating Voltage: The voltage by which the relay performs to the desired function.

Pin Diagram: A diagram of the points at which a connection is made between the relay and the circuit board.

Protection Rating: Classification system for the sealing effectiveness of electrical equipment to protect against foreign bodies. In a two digit code, the first digit indicates the protection against solid objects, while the second indicates protection from moisture.

International Protection (IP, according to IEC 529): Protection against a process whereby unwanted material enter the relay to occupy space that would otherwise remain free of such material.

IP 40, First digit 4: Protection from entry by solid objects with a diameter greater than 1.0 mm.
Second digit 0: no special protection against moisture

IP 67, First digit 6: Dust-tight.
Second digit 7: Protection against immersion.

Relay Operate Time: The time interval from coil energization to the functioning time of the last contact to function.

Relay Release Time: The time interval from coil de-energization to the functioning time of the last contact to function.

Safety Relay: An electro-mechanical relay with forced-guided contacts used in Safety Devices such as Emergency Stop Modules, Safety Gate Monitors, 2-Hand Safety Modules, Safety Light Curtains, etc.

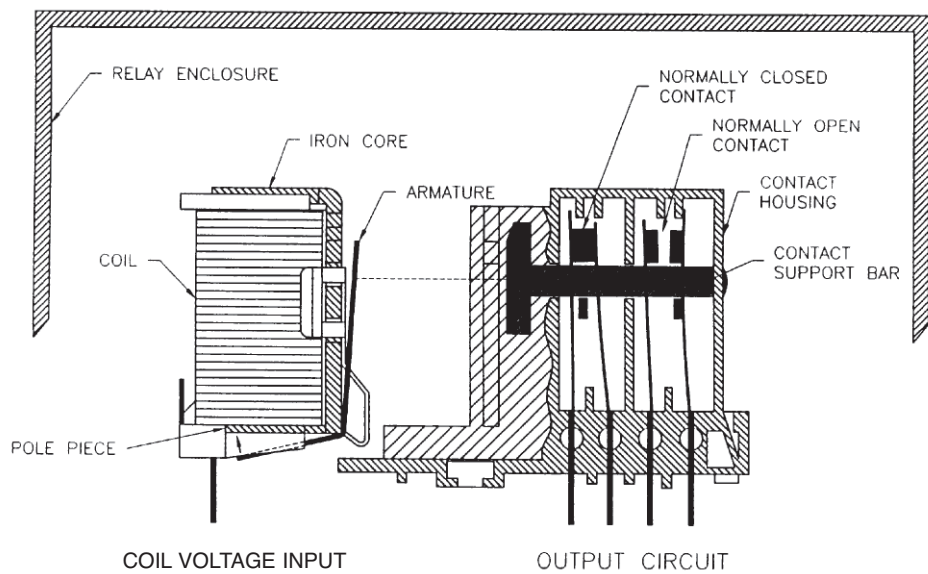

Switching Current: The value of the root-mean-square (rms) symmetrical current expressed in amperes, which the relay output contact interrupts at the rated maximum voltage and rated frequency.

Switching Power: The value of the product of switching voltage x switching current, which the relay output interrupts under certain test conditions.

Switching Voltage: The value of the voltage expressed in volt, which the relay output contact interrupts at the rated maximum current and rated frequency.

Voltage Range: The region between the lower and upper limits in regards of the Nominal Coil Voltage.

Washable: A sealed construction allows automatic washing and cleaning of the PC board.

Accessories

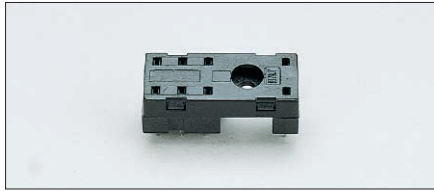

PCB Socket for OA/OW 5669*

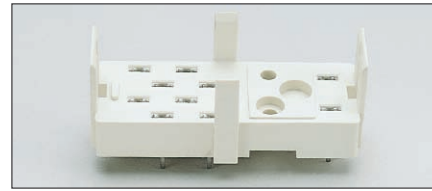

Socket for OA 5601*

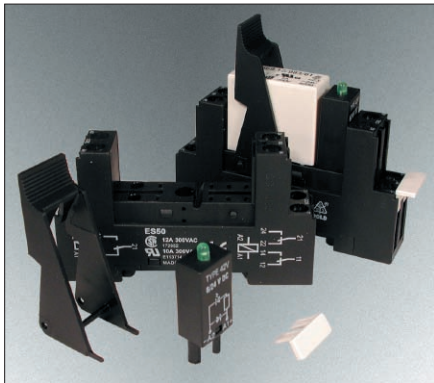

DIN Rail Socket for OA/OW 5669*

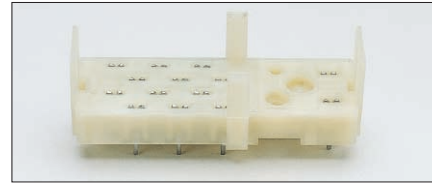

Socket for OA 5602*

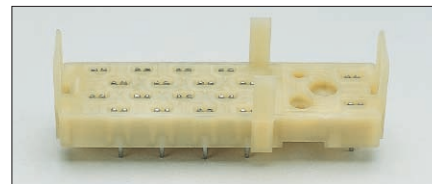

Socket for OA 5603*

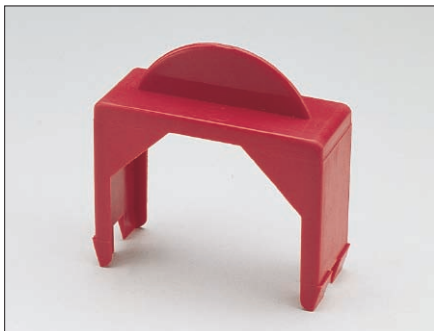

Extraction Tool**

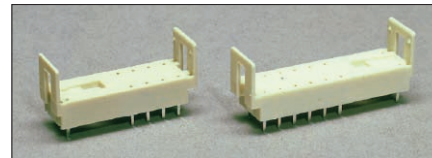

Socket for OA 5611/12*

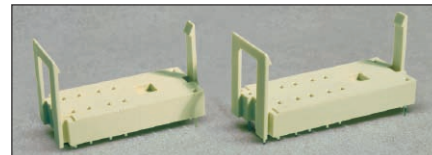

Socket for OA 5611/12*



**Note: Extraction tool for de-mounting the relay from the socket is only available for OA5601/02/03.

Ordering Information

Relay Style	Matching Socket	Socket Type	Extraction-Tool Type	Hold Down Clip Type	LED Module AC/DC, Green LED	Diode Module DC Red, LED
OA/OW 5669	56.5669.00	PCB	n.a.	56.5669.99	n.a.	n.a.
OA/OW 5669	56.5669.DR	DIN Rail	n.a.	included	56.5669.GR	56.5669.RE
OA 5667	n.a.	PCB	n.a.	n.a.	n.a.	n.a.
OA 5601	56.5601.01	PCB	56.5601.10	n.a.	n.a.	n.a.
OA 5602	56.5602.02	PCB	56.5602.20	n.a.	n.a.	n.a.
OA 5603	56.5603.03	PCB	56.5603.30	n.a.	n.a.	n.a.
OA 5611	56.5611.11	PCB	n.a.	n.a.	n.a.	n.a.
OA 5612	56.5612.12	PCB	n.a.	n.a.	n.a.	n.a.
OA 5621	56.5621.21	PCB	n.a.	n.a.	n.a.	n.a.
OA 5622	56.5622.22	PCB	n.a.	n.a.	n.a.	n.a.

*Current data sheets of sockets are available on request.

INDEX

Part Number	Page	Part Number	Page	Part Number	Page
156.OA01. _ _ _ _ C	28	56.OA67. _ _ _ _ N	15	8955.2S	26
156.OA02. _ _ _ _ C	30	56.OA67. _ _ _ _ S	15	8955.3C	26
156.OA11. _ _ _ _ C	28	56.OA67S. _ _ _ _ C	15	8955.3N	26
156.OA12. _ _ _ _ C	30	56.OA67S. _ _ _ _ N	15	8955.3S	26
256.OA01. _ _ _ _ C	28	56.OA67S. _ _ _ _ S	15	8956.2C	26
256.OA02. _ _ _ _ C	30	56.OA69. _ _ _ _ C	7	8956.2N	26
256.OA11. _ _ _ _ C	28	56.OA69. _ _ _ _ N	7	8956.2S	26
256.OA12. _ _ _ _ C	30	56.OA69. _ _ _ _ S	7	8956.3C	26
456.OA01. _ _ _ _ C	28	56.OA70. _ _ _ _ C	9	8956.3N	26
456.OA02. _ _ _ _ C	30	56.OA70. _ _ _ _ N	9	8956.3S	26
456.OA11. _ _ _ _ C	28	56.OA70. _ _ _ _ S	9	8963.2C	26
456.OA12. _ _ _ _ C	30	56.OW69. _ _ _ _ C	7	8963.2N	26
56.5601.01	35	56.OW69. _ _ _ _ N	7	8963.2S	26
56.5601.10	35	56.OW69. _ _ _ _ S	7	8972.2C	26
56.5602.02	35	56.OW70. _ _ _ _ C	9	8972.2N	26
56.5602.20	35	56.OW70. _ _ _ _ N	9	8972.2S	26
56.5603.03	35	56.OW70. _ _ _ _ S	9		
56.5603.30	35	8923.2C	26		
56.5611.11	35	8923.2N	26		
56.5612.12	35	8923.2S	26		
56.5621.21	35	8923.3C	26		
56.5622.22	35	8923.3N	26		
56.5669.00	35	8923.3S	26		
56.5669.99	35	8924.2C	26		
56.5669.DR	35	8924.2N	26		
56.5669.GR	35	8924.2S	26		
56.5669.RE	35	8924.4C	26		
56.OA01. _ _ _ _ C	21	8924.4N	26		
56.OA01. _ _ _ _ N	21	8924.4S	26		
56.OA01. _ _ _ _ S	21	8926.2C	26		
56.OA02. _ _ _ _ C	23	8926.2N	26		
56.OA02. _ _ _ _ N	23	8926.2S	26		
56.OA02. _ _ _ _ S	23	8926.3C	26		
56.OA03. _ _ _ _ C	25	8926.3N	26		
56.OA03. _ _ _ _ N	25	8926.3S	26		
56.OA03. _ _ _ _ S	25	8927.2C	26		
56.OA11. _ _ _ _ C	17	8927.2N	26		
56.OA11. _ _ _ _ N	17	8927.2S	26		
56.OA11. _ _ _ _ S	17	8927.3C	26		
56.OA12. _ _ _ _ C	19	8927.3N	26		
56.OA12. _ _ _ _ N	19	8927.3S	26		
56.OA12. _ _ _ _ S	19	8949.2C	26		
56.OA21. _ _ _ _ C	11	8949.2N	26		
56.OA21. _ _ _ _ N	11	8949.2S	26		
56.OA21. _ _ _ _ S	11	8949.3C	26		
56.OA21S. _ _ _ _ C	11	8949.3N	26		
56.OA21S. _ _ _ _ N	11	8949.3S	26		
56.OA21S. _ _ _ _ S	11	8951.2C	26		
56.OA22. _ _ _ _ C	13	8951.2N	26		
56.OA22. _ _ _ _ N	13	8951.2S	26		
56.OA22. _ _ _ _ S	13	8951.3C	26		
56.OA22S. _ _ _ _ C	13	8951.3N	26		
56.OA22S. _ _ _ _ N	13	8951.3S	26		
56.OA22S. _ _ _ _ S	13	8955.2C	26		
56.OA67. _ _ _ _ C	15	8955.2N	26		

