

# High Precision, 2-color Display Digital Pressure Switch Series **ZSE30/ISE30**

## How to Order

### Option 1

Nil	Without lead wire 
L	Lead wire with connector (Lead wire length: 2 m) 

For positive pressure

**ISE30** — 01 — 25 — M — [ ] — [ ]

For vacuum/low pressure

**ZSE30** — 01 — 25 — M — [ ] — [ ]

### Piping specifications

01	R 1/8 (With M5 female thread)	
T1	NPT 1/8 (With M5 female thread)	
C4H	ø4 One-touch fitting ø5/32" One-touch fitting	Straight type 
C6H	ø6 One-touch fitting	
N7H	ø1/4" One-touch fitting	
C4L	ø4 One-touch fitting ø5/32" One-touch fitting	Elbow type 
C6L	ø6 One-touch fitting	
N7L	ø1/4" One-touch fitting	

### Output specifications

25	NPN output
65	PNP output
26	1 to 5 V output
28	4 to 20 mA output

### Option 2

Nil	None
A	Bracket 
B	Panel mount 
D	Panel mount adapter + Front protective cover 

### Unit specifications

Nil	With unit switching function
M	Fixed SI unit (International System of Units) <sup>Note)</sup>

Note) Fixed unit:  
For vacuum/Low pressure: kPa  
For positive pressure: MPa

### Option Part No.

When optional parts are required separately, use the following part numbers to place an order.

Option	Part no.	Note
Lead wire with connector	ZS-27-A	Lead wire length: 2 m
Bracket	ZS-27-B	With mounting screws (M3 x 5L: 2 pcs.)
Panel mount adapter	ZS-27-C	With M3 x 8L (2 pcs.)
Panel mount adapter + Front protective cover	ZS-27-D	With M3 x 8L (2 pcs.)

# High Precision, 2-color Display Digital Pressure Switch **Series ZSE30/ISE30**

## Specifications



		ZSE30 (Vacuum/Low pressure)	ISE30 (Positive pressure)
Rated pressure range		-100.0 to 100.0 kPa	0.000 to 1.000 MPa
Regulating pressure range		-101.0 to 101.0 kPa	-0.100 to 1.000 MPa
Proof pressure		500 kPa	1.5 MPa
Min. regulating unit		0.2 kPa	0.001 MPa
Fluid		Air, Inert gas, Non-flammable gas	
Power supply voltage		12 to 24 VDC, Ripple (p-p) 10% or less (With power supply polarity protection)	
Current consumption		45 mA or less (at no load)	
Switch output <sup>Note 1)</sup>		NPN or PNP open collector output: 1 output	
Max. load current		80 mA	
Max. applied voltage		30 V (With NPN output)	
Residual voltage		1 V or less (With load current of 80 mA)	
Response time		2.5 ms or less (Response time selections with anti-chattering function: 20, 160, 640, 1280 ms)	
Short circuit protection		Yes	
Repeatability		±0.2% F.S. ±2 digit or less	±0.2% F.S. ±1 digit or less
Analog output	Voltage output <sup>Note 2)</sup>	Output voltage: 1 to 5 V ±2.5% F.S. or less (With rated pressure range) Linearity: ±1% F.S. or less, Output impedance: Approx. 1 kΩ	
	Current output <sup>Note 3)</sup>	Output current: 4 to 20 mA ±2.5% F.S. or less (With rated pressure range) Linearity: ±1% F.S. or less Maximum load impedance: 300 Ω with power supply voltage of 12 V; 600 Ω with power supply voltage of 24 V Minimum load impedance: 50 Ω	
Hysteresis	Hysteresis mode	Adjustable (can be set from 0)	
	Window comparator mode		
Display		3 1/2 digit, 7-segment indicator, 2-color display (Red and green) Sampling cycle: 5 times/s	
Display accuracy		±2% F.S. ±2 digit (at 25°C ambient temperature)	±2% F.S. ±1 digit (at 25°C ambient temperature)
Indicator light		Light up when output is ON (Green)	
Temperature characteristics		±2% F.S. or less (based on 25°C)	
Environmental resistance	Enclosure	IP40	
	Operating temperature range	Operating: 0 to 50°C, Stored: -10 to 60°C (No freezing or condensation)	
	Operating humidity range	Operating and stored: 35 to 85% RH (No condensation)	
	Withstand voltage	1000 VAC for 1 min. between live parts and enclosure	
	Insulation resistance	50 MΩ or more between live parts and enclosure (at 500 VDC)	
	Vibration resistance	10 to 150 Hz, 1.5 mm or 20 m/s <sup>2</sup> amplitude in X, Y, Z directions for 2 hours each	
Impact resistance		100 m/s <sup>2</sup> in X, Y, Z directions 3 times each	
Standard		Compliant with CE Marking and UL (CSA) standards	

Note 1) When switch output is selected, analog output is not available.

Note 2) When voltage output is selected, a simultaneous selection of switch output and current output is not available.

Note 3) When current output is selected, a simultaneous selection of switch output and voltage output is not available.

## Piping Specifications

Part		01	T1	C4H	C6H	N7H	C4L	C6L	N7L
		R 1/8 M5 x 0.8	NPT 1/8 M5 x 0.8	—	—	—	—	—	—
Port size	One-touch fitting Straight type	—	—	ø4 mm ø5/32 inch	ø6 mm	ø1/4 inch	—	—	—
	One-touch fitting Elbow type	—	—	—	—	—	ø4 mm ø5/32 inch	ø6 mm	ø1/4 inch
Wetted part material		Sensor pressure receiving area: Silicon, Piping port: C3602 (Electroless nickel plated), O-ring: HNBR							
					O-ring: NBR		O-ring: NBR, fitting: PBT		
Weight	With lead wire with connector (2 m)	81 g		76 g		78 g			
	Without lead wire with connector	43 g		38 g		40 g			

ZSE□  
ISE□

PSE

ZSE3

PS

ZSE<sub>1</sub><sup>2</sup>

ZSP

ISA2

IS□

ZSM

PF2□

IF□

Data

# Series ZSE30/ISE30

## Setting

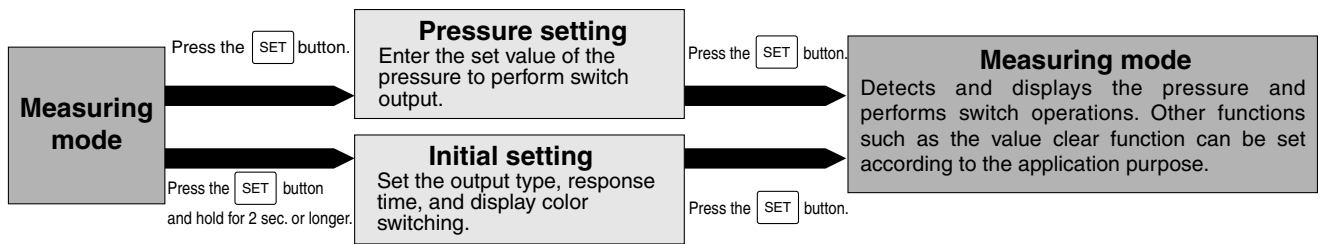

### Initial Setting

#### Initial setting mode

Press and hold the SET button for 2 seconds or longer. Display monitor will be per Figure A below, and the switch will now be in the display color setting mode.

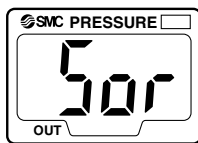
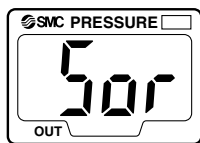

Figure A

If the unit specification indicated at the time of ordering is "M", the fixed SI unit will be used. If it is Nil, refer to "Unit Switching Function" on page 16-2-8.

#### 1. Display color setting

Select the color for LCD display. Press the  $\Delta$ UP or  $\nabla$ DOWN button to choose a display color.



ON: Red

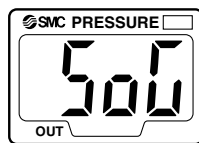

ON: Green

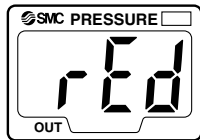

ON/OFF: Red

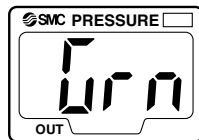

ON/OFF: Green

Press the SET button to set the color and proceed to the operating mode setting.

If the analog output is set, press the  $\Delta$ UP or  $\nabla$ DOWN button and select the desired display color from Grn (Green) or rEd (Red). Press the SET button to exit this mode and return to the measuring mode.

#### 2. Operating mode setting

This mode will let you select the switch operating mode. While the current operating mode is displayed, press the  $\Delta$ UP or  $\nabla$ DOWN button to select a newly desired operating



Hysteresis mode

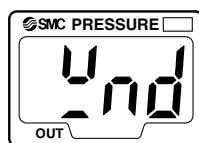

Window comparator mode

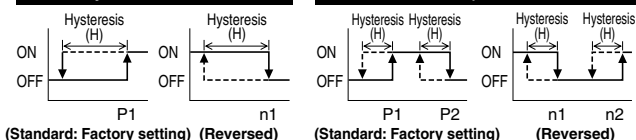

(Standard: Factory setting) (Reversed) (Standard: Factory setting) (Reversed)

Press the SET button to set the mode and proceed to the output type setting.

#### 3. Output type setting

The type of switch output can be set arbitrarily. While the current output type is displayed, press the  $\nabla$ DOWN button to switch between normally open  $nO$  and normally closed  $nL$ .

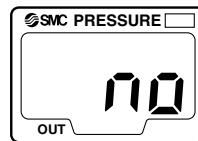

Normally open

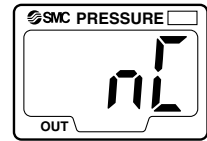

Normally closed

Press the SET button to set the output type and proceed to the response time setting.

#### 4. Response time setting

The switch output response time can be set arbitrarily. Chattering can be prevented with a response time setting. While the current response time is displayed, press the  $\Delta$ UP or  $\nabla$ DOWN button to select a new response time.

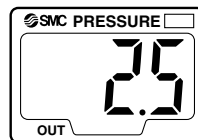

2.5 ms



20 ms



160 ms

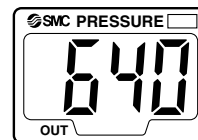

640 ms



1280 ms

Press the SET button to set the response time and proceed to the auto preset setting.

If the operating mode is the window comparator mode, press the SET button to return to the measuring mode.

#### 5. Auto preset setting

This function stores the measuring pressure that is set during the auto preset mode as a basic value.

While the current setting is displayed, press the  $\Delta$ UP or  $\nabla$ DOWN button to select it as an auto preset setting.

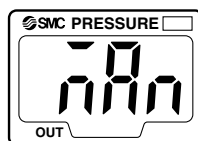

Manual



Auto

Press the SET button to set the auto preset and return to the measuring mode.

## Pressure setting

### Manual setting

Press the SET button in the measuring mode to display the set value.  $P_1$  and the current set value blink alternately.

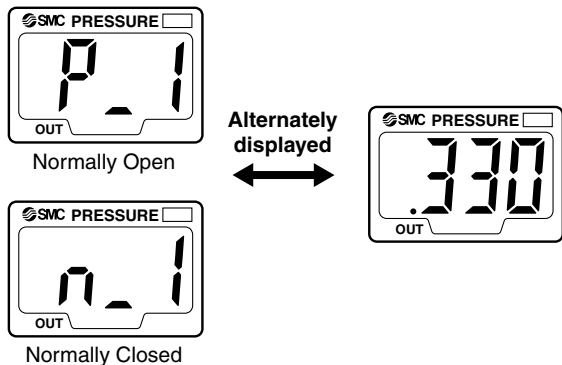

Press the SET button to display the next set value. Press the  $\Delta$ UP or  $\nabla$ DOWN button to change the value. (Refer to "How to Set Value" on the lower right hand corner of this page.)

### Hysteresis mode

In this mode, hysteresis (H) and the set value for hysteresis are displayed alternately after setting P1. Press the SET button to return to the normal measuring mode. Press the  $\Delta$ UP or  $\nabla$ DOWN button to change the value. (Refer to "How to Set Value" below right.)

### Window comparator mode

In this mode, P2 and the current set value are displayed alternately after setting P1. Press the SET button to display the next set value (H: hysteresis). Press the  $\Delta$ UP or  $\nabla$ DOWN button to change the value. (Refer to "How to Set Value" at right.)

Next, H and the set value for hysteresis will be displayed alternately. Press the SET button to return to the normal measuring mode. Press the  $\Delta$ UP or  $\nabla$ DOWN button to change the value. (Refer to "How to Set Value" at right.)

Pressure set value can be verified without holding or stopping the switch output operation.

## Auto preset setting

### 1. Auto preset preparation mode

While in the measuring mode, press the SET button to activate the auto preset preparation mode, and  $AP1$  will be displayed. Proceed to prepare the devices to perform the pressure setting. While  $AP1$  is still displayed, press both the  $\Delta$ UP and  $\nabla$ DOWN buttons simultaneously to return to the measuring mode.

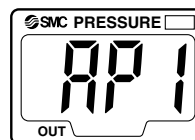

### 2. Auto preset setting

Press the SET button to activate the mode to execute auto preset functions. When  $AL$  is displayed, start the system operation and change the pressure. The set value will be automatically detected and stored. While  $AL$  is still displayed, press the SET button to complete the setting and return to the normal measuring mode.

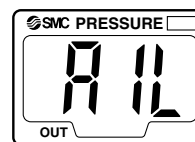

### How to Set Value

To enter a value such as the one for pressure setting:

1. Press the  $\Delta$ UP or  $\nabla$ DOWN button to change the set value. The first digit blinks.



1st digit

2. Press the  $\Delta$ UP or  $\nabla$ DOWN button to set the value arbitrarily. (If there is no button operation for more than 10 seconds, the current value will be automatically set and the function will return to the set value display mode.)

3. With every push of the SET button, the next (higher) digit blinks.



2nd digit



3rd digit

When the left-most digit is zero, "i" or "j" will blink. If the SET button is pressed while the left-most digit is blinking, the right-most digit will now blink.



4. Press and hold the SET button for 1 second or longer to return to the set value display mode.

ZSE□  
ISE□

PSE

ZSE3

PS

ZSE1

ZSE2

ZSP

ISA2

IS□

ZSM

PF2□

IF□

Data

# Series ZSE30/ISE30

## Setting

### Function setting

#### Display calibration

During measuring mode, press the SET and  $\nabla$ DOWN buttons simultaneously and hold for 2 seconds or longer. F5L and current measured value will be displayed.

Press the  $\Delta$ UP or  $\nabla$ DOWN button to change the set value. If there is no button operation for more than 2 seconds after changing the set value, the display mode returns to displaying F5L and the current measured value.

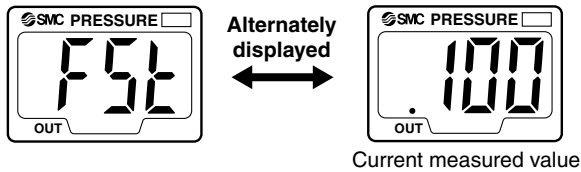

Press the SET button to display the adjusted value (percent). The adjusted value and F5L will be alternately displayed.

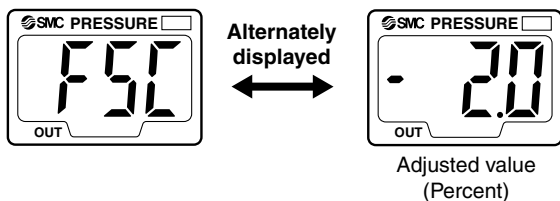

Press the SET button to return to the normal measuring mode.

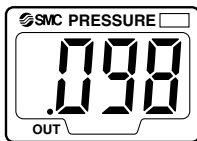

This function eliminates slight differences in the output values and allows uniformity in the numbers displayed. Displayed values of the pressure sensor can be calibrated to within  $\pm 5\%$  for Series ISE and  $\pm 2.5\%$  for Series ZSE.

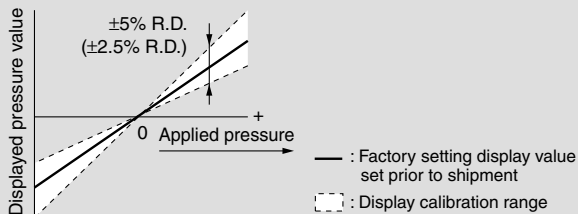

Note) When the display calibration function is used, the regulating pressure value may change  $\pm 1$  digit.

#### Peak/Bottom hold function

This function constantly detects and updates the maximum and minimum pressure values and allows to hold the display value.

To use a peak hold function, press and hold the  $\Delta$ UP button for 1 second or longer. The maximum pressure value is held and blinks repeatedly. Press and hold the  $\Delta$ UP button again for 1 second or longer to release this function and return to the measuring mode.

To use a bottom hold function, press the  $\nabla$ DOWN button for 1 second or longer. The minimum pressure value is held and blinks repeatedly. Press and hold  $\nabla$ DOWN button again for 1 second or longer to release this function and return to the measuring mode.

#### Key lock function

This function prevents incorrect operations such as changing the set value accidentally. Press the SET button and hold for 4 seconds or longer to display the current Loc or Unl setting. Press the  $\Delta$ UP or  $\nabla$ DOWN button to select the setting and set this function with the SET button. Use the Loc mode to avoid accidental button operation. To release a key lock function, press the SET button and hold for 4 seconds or longer to display the current setting, and select the Unl mode.

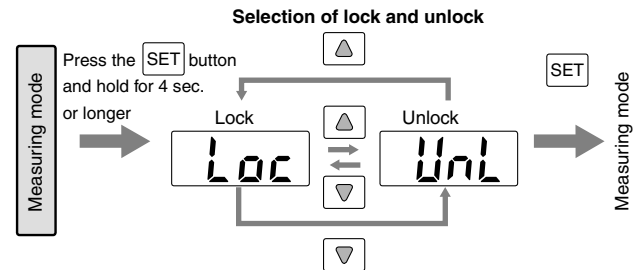

#### Zero out (Zero ADJ) function

This function clears and resets the displayed value as long as the measuring pressure is within  $\pm 70$  digits of the atmospheric pressure.

(Due to individual product differences, the setting range varies  $\pm 10\%$  F.S.)

This function is effective in detecting pressure fluctuations that exceed a certain amount without being affected by the supply pressure. Press and hold the  $\Delta$ UP and  $\nabla$ DOWN buttons simultaneously to reset the display. Release the buttons to return to the measuring mode.

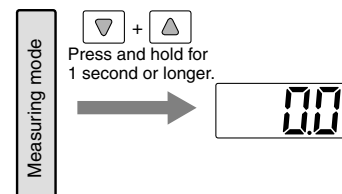

#### Unit Conversion Function

##### When not selecting "M" for unit specification

Desired display unit can be selected.

Press the  $\Delta$ UP or  $\nabla$ DOWN button to switch the unit, and the set value is automatically converted.

The conversion order is: Pa $\leftrightarrow$ kgf/cm<sup>2</sup> $\leftrightarrow$ bar $\leftrightarrow$ psi $\leftrightarrow$ inchHg $\leftrightarrow$ mmHg

Press the SET button to set the unit and proceed to the display color setting.

**For vacuum/low pressure** Pa $\leftrightarrow$ kgf/cm<sup>2</sup> $\leftrightarrow$ bar $\leftrightarrow$ psi $\leftrightarrow$ inchHg $\leftrightarrow$ mmHg

**For positive pressure** MPa $\leftrightarrow$ kgf/cm<sup>2</sup> $\leftrightarrow$ bar $\leftrightarrow$ psi

##### Indication of Units

Displayed unit	ISE30	ZSE30
Pa	0.001 MPa	0.2 kPa
kgf/cm <sup>2</sup>	0.01	0.002
bar	0.01	0.002
psi	0.2	0.05
mmHg	—	2
inchHg	—	0.2

# High Precision, 2-color Display Digital Pressure Switch Series ZSE30/ISE30

## Description

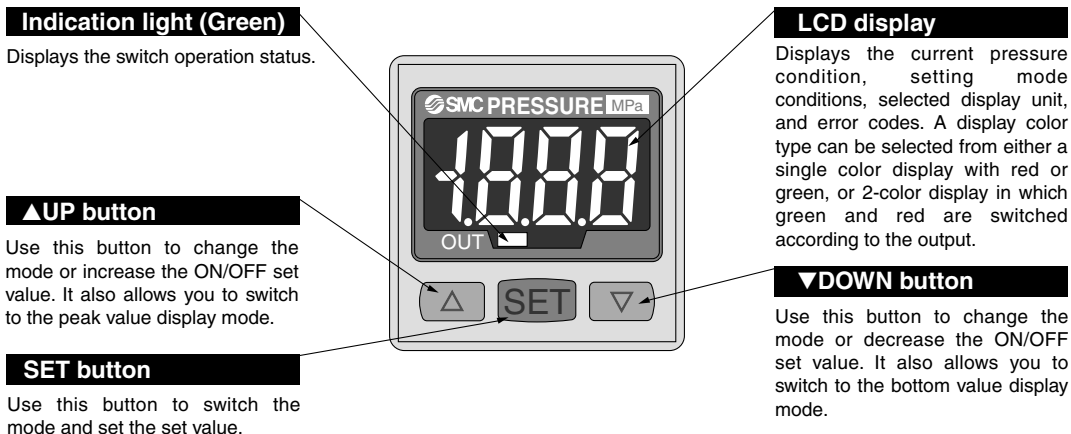

## Error Correction

Take the following corrective solutions when errors occur.

Error description	LCD display	Condition	Solution
over-current error	Er 1	Load current of switch output is more than 80 mA.	Shut off the power supply. After eliminating the output factor that caused the excess current, turn the power supply back on.
Residual pressure error	Er 3	Pressure is applied during the zero out operation as follows: When the switch for positive pressure is used: $\pm 0.071$ MPa or more. When the switch positive pressure is used: $\pm 7.1$ kPa or more. After displaying for 3 seconds, it will return to the measuring mode. Due to the individual product difference, the setting range varies $\pm 10\%$ F.S.	Bring the pressure back to atmospheric pressure and try using the zero out function.
Applied pressure error	HHH	Supply pressure exceeds the maximum regulating pressure.	Reduce/increase supply pressure to within the regulating pressure range.
	LLL	Supply pressure is below the minimum regulating pressure.	
System error	Er 4	Internal data error	Shut off the power supply. Turn the power supply back on. If the power should not come back on, please contact SMC for an inspection.
	Er 6	Internal data error	
	Er 7	Internal data error	
	Er 8	Internal data error	

## Example of Internal Circuit and Wiring

**-25**  
**NPN open collector output**  
Maximum 30 V, 80 mA  
Residual voltage:  
1 V or less

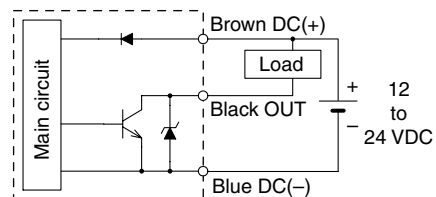

**-26**  
**Analog output type**  
1 to 5 V ( $\pm 2.5\%$  F.S.)  
Output impedance:  
1 k $\Omega$

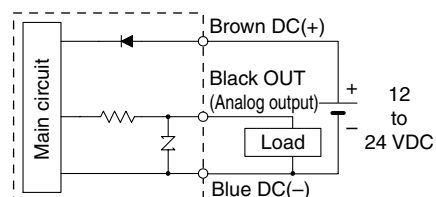

**-28**  
**Analog output type**  
4 to 20 mA ( $\pm 2.5\%$  F.S.)  
Maximum load impedance:  
Power supply voltage 12 V: 300  $\Omega$   
Power supply voltage 24 V: 600  $\Omega$   
Minimum load impedance: 50  $\Omega$

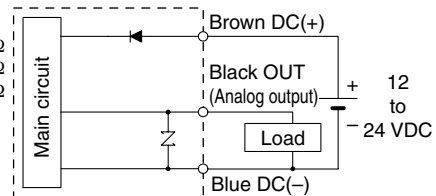

**-65**  
**PNP open collector**  
Maximum 80 mA

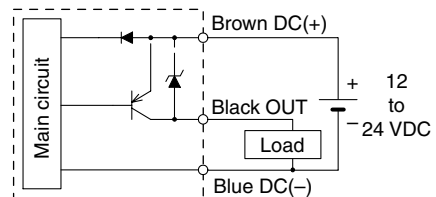

ZSE□  
ISE□

PSE

ZSE3

PS

ZSE1

ZSP

ISA2

IS□

ZSM

PF2□

IF□

Data

# Series ZSE30/ISE30

## Dimensions

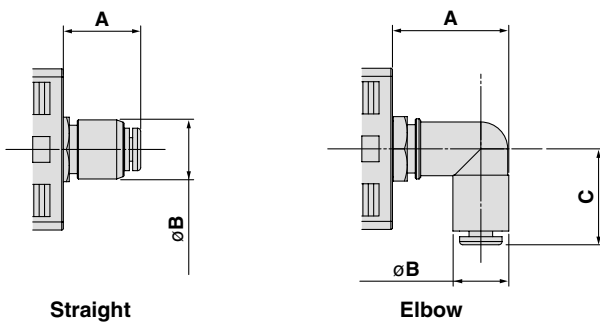
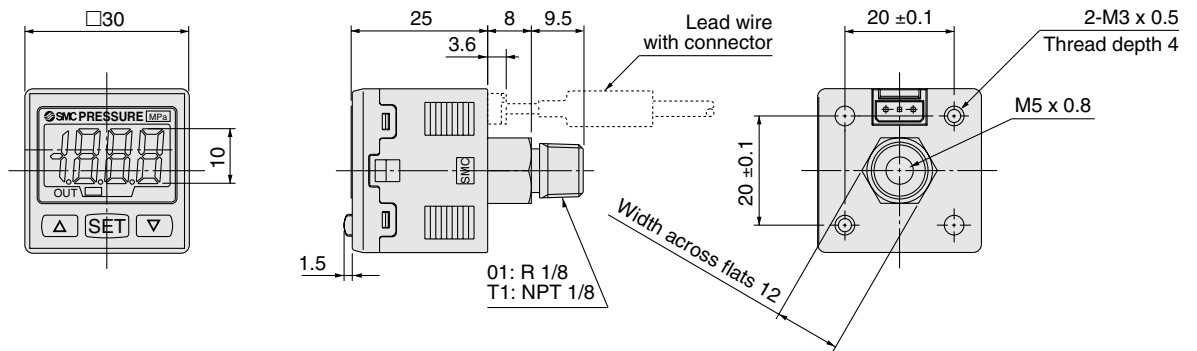

Straight

Elbow

With One-touch fitting

One-touch fitting size	Straight		Elbow		
	A	B	A	B	C
ø4, ø5/32"	14.4	11.2	20	10.4	18
ø6			22.4	12.8	20
ø1/4"			22.8	13.2	20.5

(mm)

## With bracket

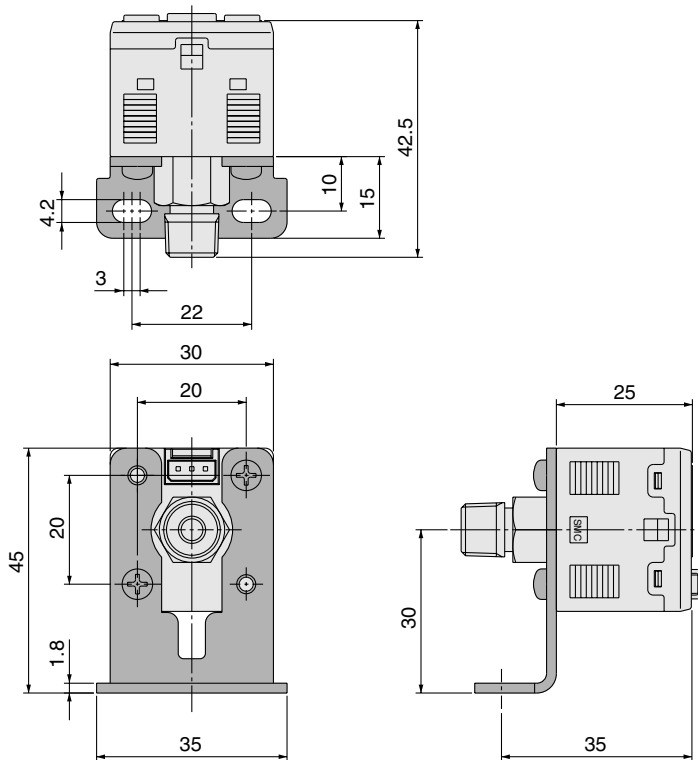

# High Precision, 2-color Display Digital Pressure Switch Series ZSE30/ISE30

## Dimensions

### Panel mount

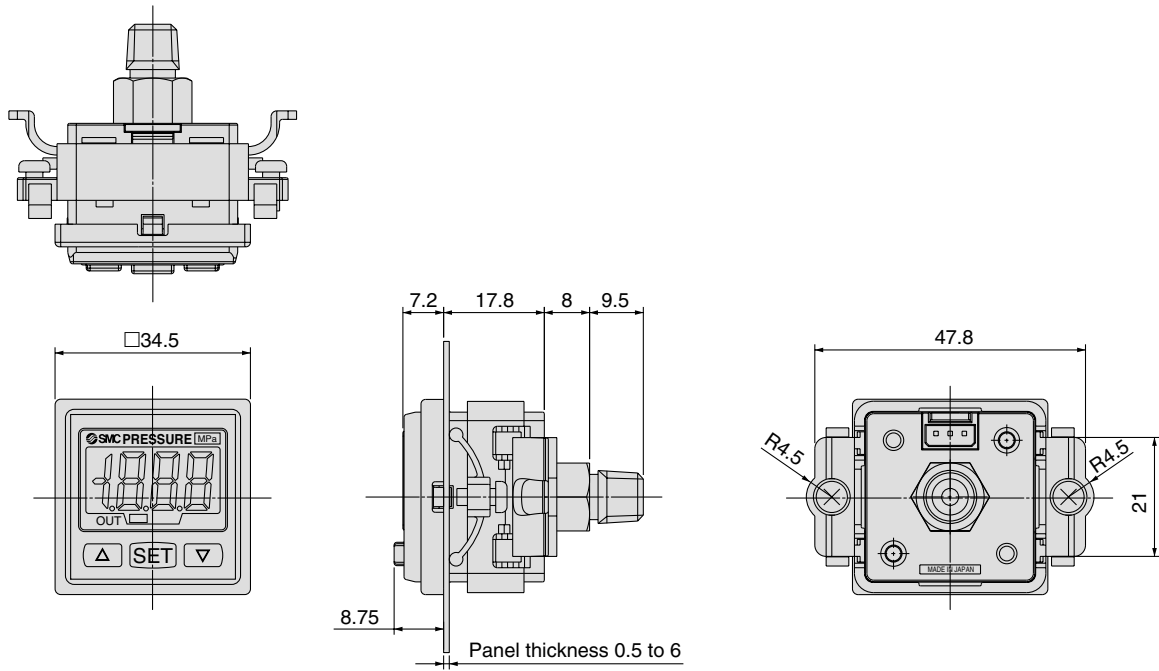

### Panel mount adapter + Front protective cover

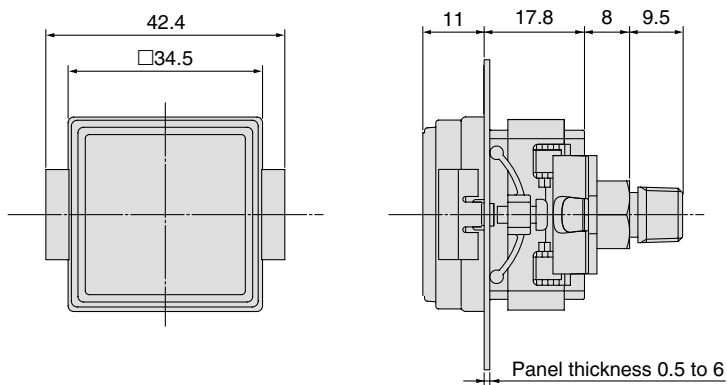

ZSE□
ISE□
PSE
ZSE3
PS
ZSE <sub>1</sub>
ZSE <sub>2</sub>
ZSP
ISA2
IS□
ZSM
PF2□
IF□
Data



# Series ZSE30/ISE30

## Dimensions

### Panel fitting dimension

#### 1-pc. mounting

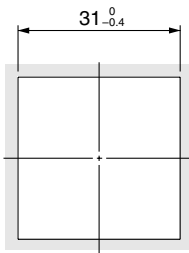

#### Multiple (2 pcs. or more) horizontal mounting

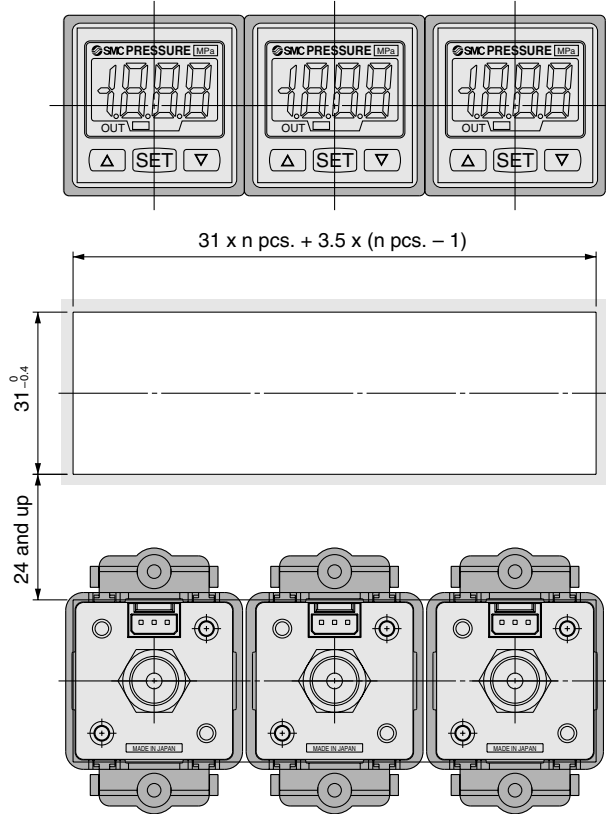

#### Multiple (2 pcs. or more) vertical mounting

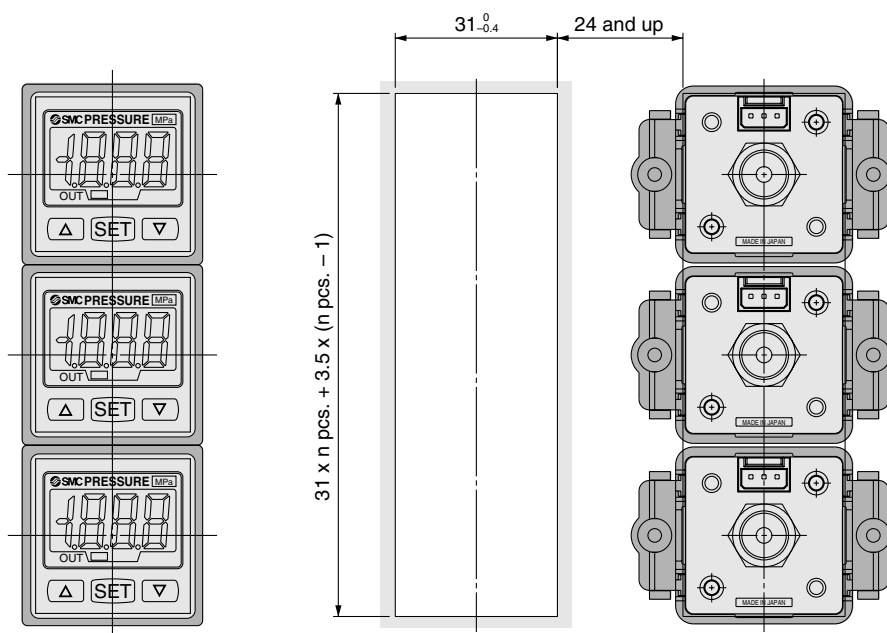



# Specific Product Precautions 1

Be sure to read before handling.

## Handling

### Warning

1. Do not drop, bump, or apply excessive impacts (980 m/s<sup>2</sup>) while handling. Although the body of the sensor may not be damaged, the internal parts of the sensor could be damaged and lead to a malfunction.
2. The tensile strength of the cord is 35 N. Applying a greater pulling force on it can cause a malfunction. When handling, hold the body of the sensor—do not dangle it from the cord.
3. Do not exceed the screw-in torque of 7 to 9 N·m when installing piping. Exceeding this value may cause malfunctioning of the sensor.
4. Do not use pressure sensors with corrosive and/or flammable gases or liquids.
5. Allow a sufficient margin of tube length in piping in order to prevent application of torsional, tensile or moment load to the tubes and fittings.
6. When a brand of tubing other than SMC is used, make sure that the tolerance of the tube's O.D. satisfies the following specifications.
  - 1) Nylon tubing: ±0.1 mm or less
  - 2) Soft nylon tubing: ±0.1 mm or less
  - 3) Polyurethane tubing: +0.15 mm or less, -0.2 mm or less
7. The applicable fluid is air. Please consult with SMC if the switch is to be used with other types of fluids.

## Connection

### Warning

1. Incorrect wiring can damage the switch and cause a malfunction or erroneous switch output. Connections should be done while the power is turned off.
2. Do not attempt to insert or pull the pressure sensor or its connector when the power is on. A switch output malfunction may occur.
3. Wire separately from power lines and high voltage lines, avoiding wiring in the same conduit with these lines. Malfunctions may occur due to noise from these other lines.
4. If a commercial switching regulator is used, make sure that the F.G. terminal is grounded.

## Operating Environment

### Warning

1. Our pressure switches are CE marked; however, they are not equipped with surge protection against lightning. Lightning surge countermeasures should be applied directly to system components as necessary.
2. Our pressure switches do not have an explosion proof rating. Never use in the presence of an explosive gas as this may cause a serious explosion.
3. Do not use in an environment where static electricity can cause problems, otherwise system failure or malfunction may result.

## Mounting

### Caution

1. Mounting with panel mount adapter

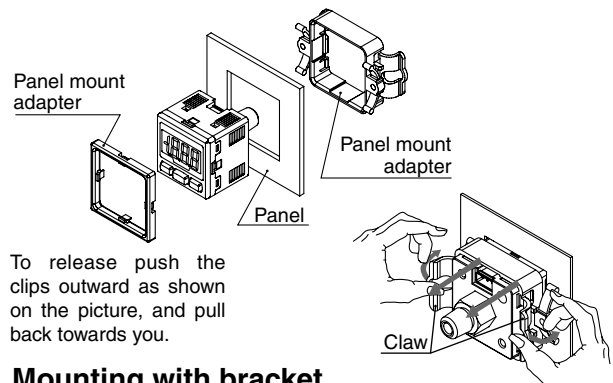

2. Mounting with bracket

Mount a bracket to the body using two M3 x 5L mounting screws and install on piping with hexagon socket head cap screws. The switch can be installed horizontally depending on the installation location.

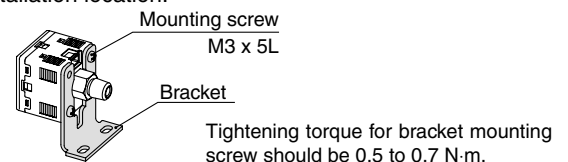

ZSE□  
ISE□

PSE

ZSE3  
I SE3

PS

ZSE1  
I SE2

ZSP

ISA2

IS□

ZSM

PF2□

IF□

Data



## Series ZSE30/ISE30

# Specific Product Precautions 2

Be sure to read before handling.

### Connection/Removal of Connector

- To connect the connector, insert it straight while pinching the lever, and then push the lever into the jack of the housing and lock it.
- To remove the connector, pull it straight out while applying pressure with your thumb to the lever and unhooking it from the jack.

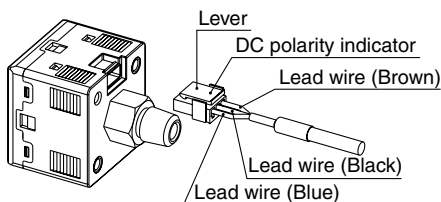

- Do not attempt to insert or pull the pressure sensor or its connector when the power is on. A switch output malfunction may occur.

### Piping

- Cut the tube perpendicularly.
- Hold the tube and insert it into the One-touch fitting carefully and securely all the way to the bottom.

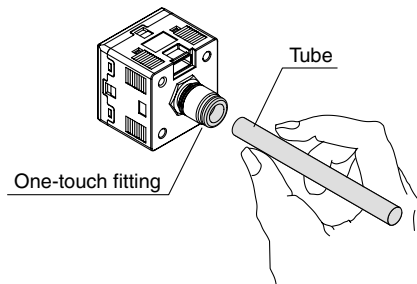

### Regulating Pressure Range and Rated Pressure Range

## Caution

#### Set the pressure within the rated pressure range.

The regulating pressure range is the range of pressure that is possible in setting.

The rated pressure range is the range of pressure that satisfies the specifications (accuracy, linearity, etc.) on the sensor.

Although it is possible to set a value outside the rated pressure range, the specifications will not be guaranteed even if the value stays within the regulating pressure range.

Switch		Pressure range				
		-100 kPa	0	100 kPa	500 kPa	1 MPa
For vacuum/ low pressure	<b>ZSE30</b>	-100 kPa	100 kPa			
		-101 kPa	101 kPa			
For positive pressure	<b>ISE30</b>	0	1 MPa			
		-100 kPa (-0.1 MPa)	1 MPa			

Rated pressure range of switch  
 Regulating pressure range of switch