

## FASP 400 – 16 in. length

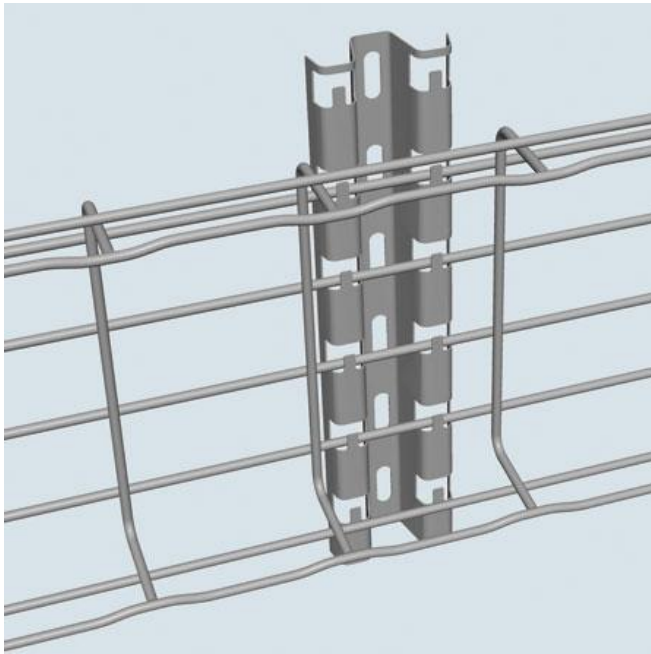

- Predrilled mounting holes make installations easy.
- Patented FAS style attachment secures tray without nuts and bolts.
- Will hold tray away from wall .66".

