

[CLICK HERE TO PRINT](#)



EZ-SnapJack™ - CAT5e

705 Series

Product Overview

705 Series

First the EZ-RJ45®, now the EZ-SnapJack! You may never again need a punchdown tool. At least for your wall jacks! The patented EZ-SnapJack is self-terminating and quickly installs for professional results in a snap.

- Save time - No need for eight punch downs
- Repair damaged jacks on the spot
- EZ-SnapJacks are re-useable
- Wire guide ensures pairs stay in proper order for fast, easy termination
- Reduced tool cost, no PDT required

Application

- Available for both Cat5e and Cat6
- Designed to fit industry standard wallplates
- Commercial network installations, new or retrofit
- Home automation installations, new or retrofit

- Compatible with insulated wire diameter of up to 0.040"
- Weight: 0.3 oz.
- Dimensions: .5" x .625" x 1.25"

Part Numbers

Part #	UPC	Description
705WH-1		EZ-SnapJack Cat5e White, Bulk Bag 1 EA
705WH-4C		EZ-SnapJack Cat5e White, ClamPack 4 EA
705LA-1		EZ-SnapJack Cat5e Light Almond, Bulk Bag 1 EA
705LA-4C		EZ-SnapJack Cat5e Light Almond, ClamPack 4 EA
705BL-1		EZ-SnapJack Cat5e Blue, Bulk Bag 1 EA
705BL-4C		EZ-SnapJack Cat5e Blue, ClamPack 4 EA
705IV-1		EZ-SnapJack Cat5e Ivory, Bulk Bag 1 EA
705IV-4C		EZ-SnapJack Cat5e Ivory, ClamPack 4 EA
705BK-1		EZ-SnapJack Cat5e Black, Bulk Bag 1 EA
705BK-4C		EZ-SnapJack Cat5e Black, ClamPack 4 EA
705YL-1		EZ-SnapJack Cat5e Yellow, Bulk Bag 1 EA
705YL-4C		EZ-SnapJack Cat5e Yellow, ClamPack 4 EA
705OR-1		EZ-SnapJack Cat5e Orange, Bulk Bag 1 EA

705OR-4C		EZ-SnapJack Cat5e Orange, ClamPack 4 EA
----------	--	---

Copyright © 2015 Platinum Tools®. All Rights Reserved.

EZ-SnapJack™

Compatible with industry standard wall plates.

Meets/Exceeds
TIA/EIA-568-B.2-1

NEW!



Prep cable

Insert wire guide

Snap together



No Tool Required!



EZ-SnapJack™

First the EZ-RJ45®, now the EZ-SnapJack! You may never again need a punchdown tool. At least for your wall jacks! The patented EZ-SnapJack is self-terminating and quickly installs for professional results in a snap.

- Save time – No need for eight punch downs
- Repair damaged jacks on the spot
- EZ-SnapJacks are re-useable
- Wire guide ensures pairs stay in proper order for fast, easy termination
- Reduced tool cost, no PDT required
- Your tool bag weighs less

Application

- Available for both Cat5e and Cat6
- Designed to fit industry standard wallplates
- Commercial network installations, new or retrofit
- Home automation installations, new or retrofit

Technical Data

- F.C.C., ULC & RoHS compliant
- 50 micro-inch selective gold plating
- Molded from UL94-VO material
- Meets/Exceeds TIA/EIA-568-B.2-1

Order Info

P/N's and color selection for both Cat5e and Cat6 EZ-SnapJacks are on the reverse side.

Phone: 800.749.5783
Fax: 800.749.5784

806 Calle Plano
Camarillo, CA 93012
www.platinumtools.com

We Make Connections EZ!

EZ-SnapJack Instructions

©2009 Platinum Tools Inc. All rights reserved. 8/09

- 1) Remove 2-3" of the outer jacket from your cable using the Cat5 & Cat6 Cable Jacket Stripper, P/N 15015. Note: There is a Cat5e and a Cat6 version of the EZ-SnapJack. Make sure you are using the proper version for your cable.

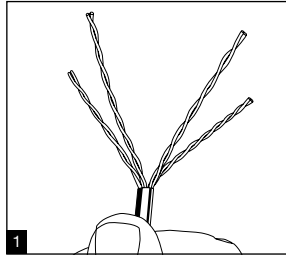

- 2) Separate pairs and lay out per the T568A or T568B specification required for your application. Use the convenient color chart on the EZ-SnapJack wire guide to assist you.

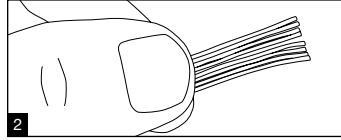

- 3) Insert the conductors through the holes in the wire guide making sure to keep them in the proper color code order.

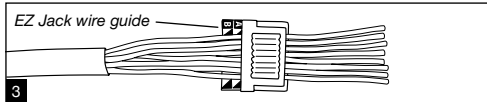

- 4) Slide the wire guide all the way down to the outer cable jacket so that it fits up against the twisted pairs of the cable.

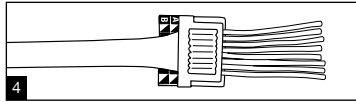

- 5) Cut off the extra wire extending from the guide so that it is flush with the wire guide edge using the Flush Cutter, P/N 10531.

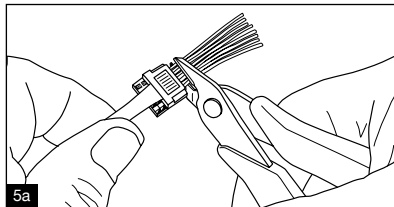
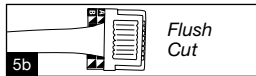

- 6) Open the EZ-SnapJack so that the hinge is on the top.

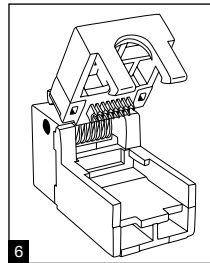

- 7) Insert the prepped cable into the jack so that the color chart on the wire guide faces up and push it all the way forward so it is flush with the EZ-SnapJack. Hold it in this position.

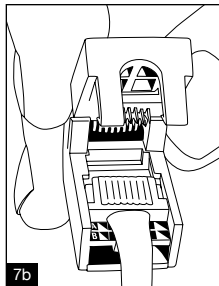
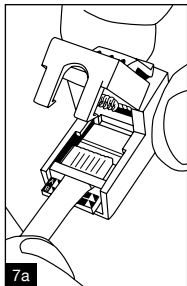

- 8) Push down on the EZ-SnapJack until it snaps completely shut.

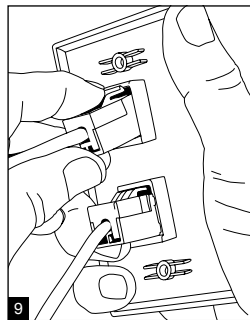
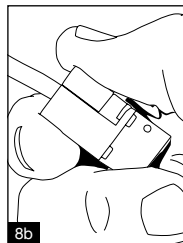
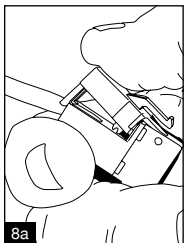

- 9) Snap the terminated EZ-SnapJack into the backside of the wall plate.

10) To Re-use EZ-SnapJacks:

Using a small slotted screwdriver, lightly pry open the two EZ-SnapJack clasps. EZ-SnapJack swings open and can now be re-used.

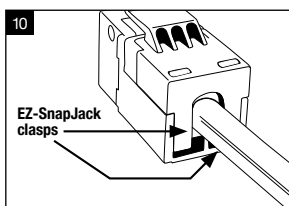

PLATINUM TOOLS®



EZ-SnapJack™ – Cat5e

Bulk Bag
1 EA

ClamPack
4 EA

EZ-SnapJack Cat5e White	705WH-1	705WH-4C
EZ-SnapJack Cat5e Light Almond	705LA-1	705LA-4C
EZ-SnapJack Cat5e Blue	705BL-1	705BL-4C
EZ-SnapJack Cat5e Green	705GN-1	705GN-4C
EZ-SnapJack Cat5e Brown	705BR-1	705BR-4C
EZ-SnapJack Cat5e Almond	705AL-1	705AL-4C
EZ-SnapJack Cat5e Ivory	705IV-1	705IV-4C
EZ-SnapJack Cat5e Black	705BK-1	705BK-4C
EZ-SnapJack Cat5e Yellow	705YL-1	705YL-4C
EZ-SnapJack Cat5e Red	705RD-1	705RD-4C
EZ-SnapJack Cat5e Orange	705OR-1	705OR-4C

EZ-SnapJack™ – Cat6

EZ-SnapJack Cat 6 White	706WH-1	706WH-4C
EZ-SnapJack Cat 6 Light Almond	706LA-1	706LA-4C
EZ-SnapJack Cat 6 Blue	706BL-1	706BL-4C
EZ-SnapJack Cat 6 Green	706GN-1	706GN-4C
EZ-SnapJack Cat 6 Brown	706BR-1	706BR-4C
EZ-SnapJack Cat 6 Almond	706AL-1	706AL-4C
EZ-SnapJack Cat 6 Ivory	706IV-1	706IV-4C
EZ-SnapJack Cat 6 Black	706BK-1	706BK-4C
EZ-SnapJack Cat 6 Yellow	706YL-1	706YL-4C
EZ-SnapJack Cat 6 Red	706RD-1	706RD-4C
EZ-SnapJack Cat 6 Orange	706OR-1	706OR-4C

©2010 Platinum Tools Inc. All rights reserved. EZ_SnapJack_PF_RevC 3/10

Phone: 800.749.5783

Fax: 800.749.5784

806 Calle Plano
Camarillo, CA 93012
www.platinumtools.com

We Make Connections EZ!

EZ-SnapJack™ Instructions

©2009 Platinum Tools Inc. All rights reserved. 8/09

PLATINUM TOOLS

- 1) Remove 2-3" of the outer jacket from your cable using the Cat5 & Cat6 Cable Jacket Stripper, P/N 15015.

Note: There is a CAT5e and a CAT6 version of the EZ-SnapJack. Make sure you are using the proper version for your cable.

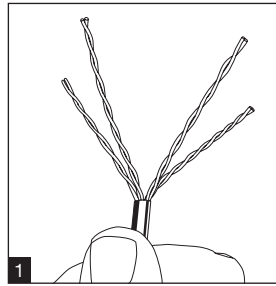

- 2) Separate pairs and lay out per the T568A or T568B specification required for your application. Use the convenient color chart on the EZ-SnapJack wire guide to assist you.

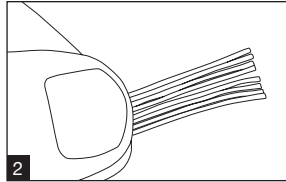

- 3) Insert the conductors through the holes in the wire guide making sure to keep them in the proper color code order.

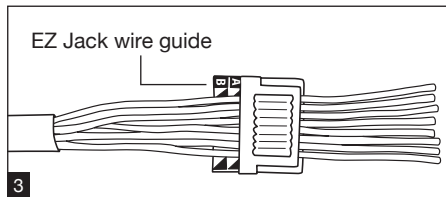

- 4) Slide the wire guide all the way down to the outer cable jacket so that it fits up against the twisted pairs of the cable.

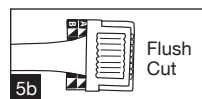
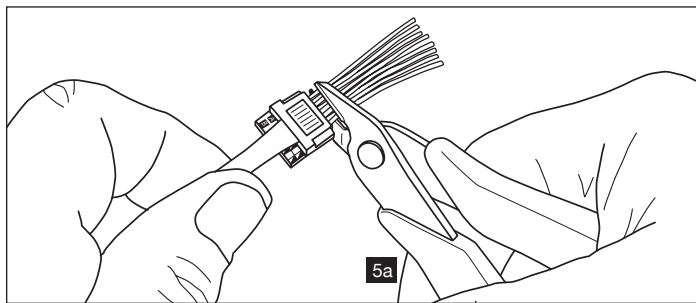
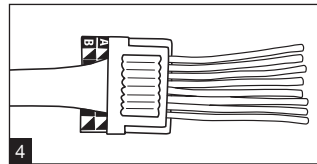

- 5) Cut off the extra wire extending from the guide so that it is flush with the wire guide edge using the Flush Cutter, P/N 10531.

- 6) Open the EZ-SnapJack so that the hinge is on the top.

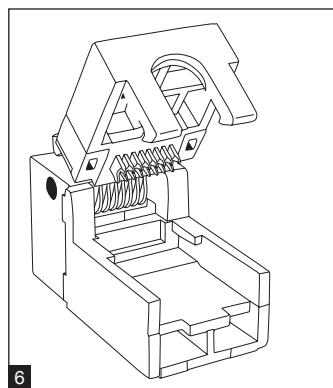

- 7) Insert the prepped cable into the jack so that the color chart on the wire guide faces up and push it all the way forward so it is flush with the EZ-SnapJack. Hold it in this position.

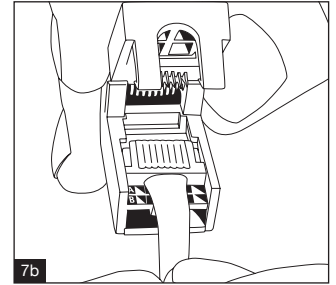
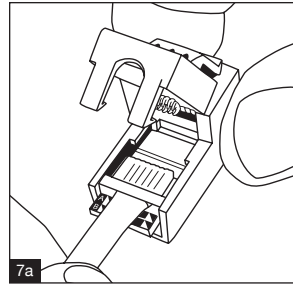

- 8) Push down on the EZ-SnapJack until it snaps completely shut.

- 9) Snap the terminated EZ-SnapJack into the backside of the wall plate.

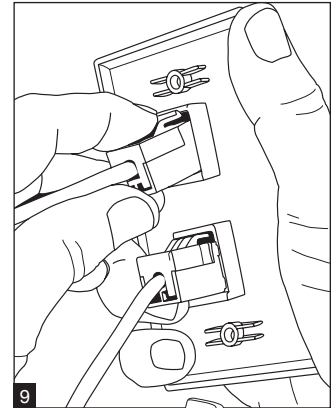
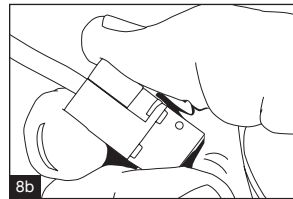
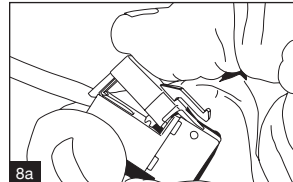

CAT6 ZizerBar (ZBar)

Using CAT6 cable with EZ-SnapJack?

The new ZizerBar re-sizes the cable opening to support smaller CAT6 diameter cable as well as CAT5e cable.

ZizerBar Installation: Insert Zbar into the EZ-SnapJack by aligning the tabs into the slots of the jack (Fig 10). Push down on the ZBar until it snaps into place & is fully seated.

To remove ZBar: Using a small slotted screwdriver, lightly pry open the two EZ-SnapJack clasps. Swing open the EZ-SnapJack then push on each ZBar tab to unlock. (Fig 11)

ZBar reduces the size of opening to support smaller diameter cables. (Fig 11)

