

Bonding and Grounding Overview

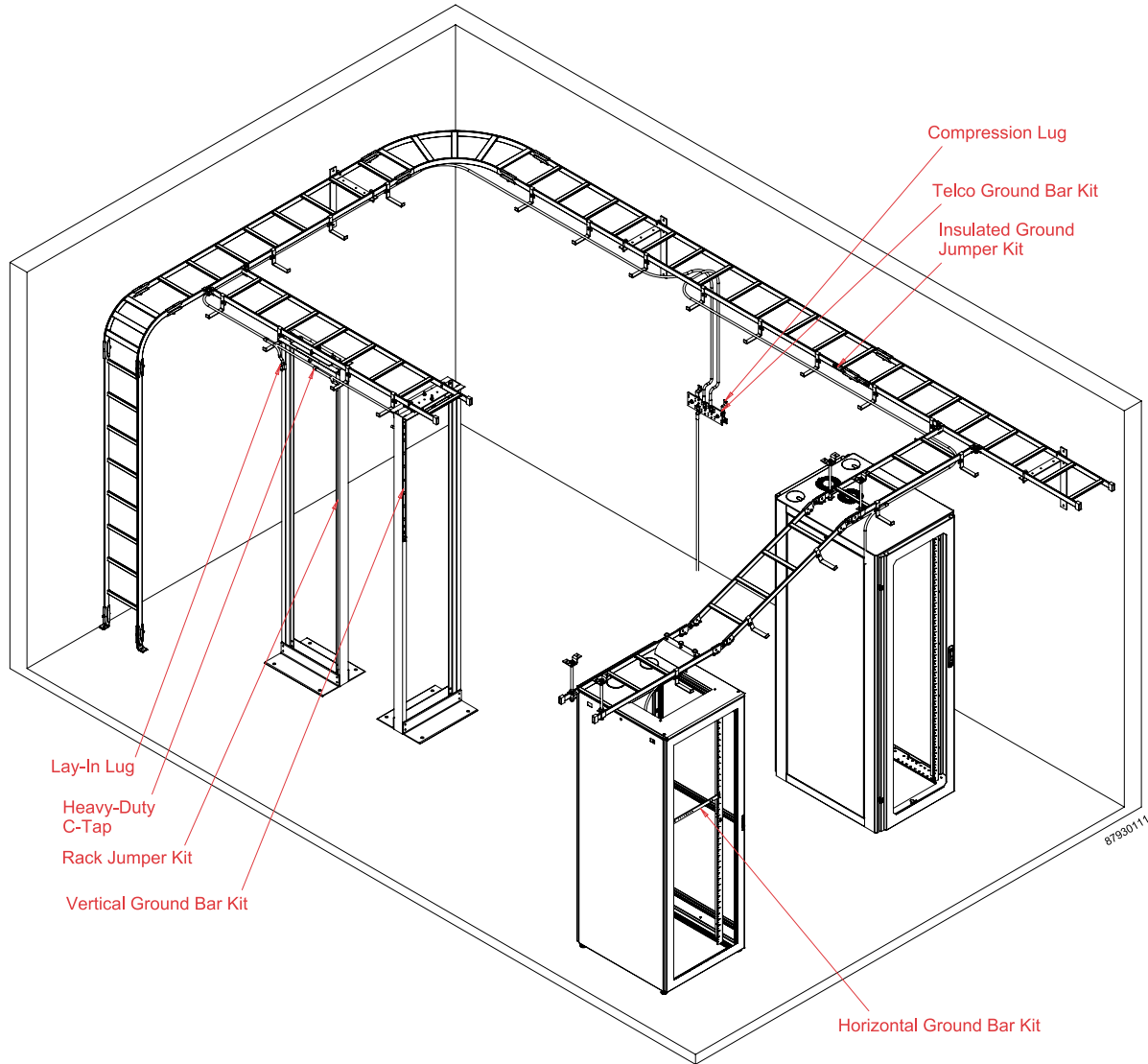

Industry Standards

Ground Bar Kits:

UL 467 Listed
cUL Listed per CSA C22.2 No. 41
File No. E319377

Application

These components meet open frame rack and cabinet bonding and grounding requirements for telecommunication room and data center applications.

Features

- Components specially designed to efficiently facilitate reliable connections
- Enable system to meet equipment manufacturer grounding requirements
- Components fit EIA 310-D-rated open frame racks

Bonding and Grounding Accessories

Lay-In Lug

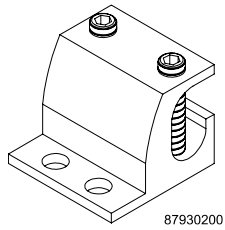

87930200

Dual-rated, UL486B listed lay-in lug bonds end of cable securely to rack. Made of electroplated 6061-T6 aluminum. Requires 3/16-in. hex key (not included).

Bulletin: DBG

Catalog Number	For Cable			Pkg. Qty.
	Size Range	Size (in.)	Size (mm)	
DGLG	#14 AWG to 2/0	1.75 x 1.50	44 x 38	10

Compression Lugs

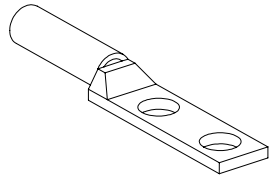

87930201

Compression lugs terminate copper or tinned-copper conductors for connection to busbars, cabinets, racks, and cable runway. Color-

coded by conductor size. Made of electroplated, tinned copper. Require two screws (not included).

Bulletin: DBG

Catalog Number	Cable Size (#)	On-Center Dimension Between Holes	Required Screw Size	Color Code	Pkg. Qty.
DGCL61	6	.625	1/4	Blue	10
DGCL62	6	1.00	3/8	Blue	10
DGCL21	2	.625	1/4	Brown	10
DGCL22	2	1.00	3/8	Brown	10
DGCL201	2/0	1.00	3/8	Black	10
DGCL402	4/0	1.00	3/8	Purple	10

Heavy-Duty C-Taps

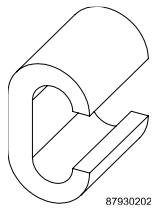

87930202

C-Taps splice two stranded or solid connectors together. Made of copper. Require a crimping tool (not included) to correctly tighten C-Taps around connectors.

Bulletin: DBG

Catalog Number	Conductor Run	Conductor Tap	Pkg. Qty.
DGT1	#2 stranded or solid	#4 stranded, #8 solid	10
DGT2	#2 stranded or solid	#2 stranded or solid	10

Bonding and Grounding Accessories

Telecommunications Ground Bar Kits

Provide a convenient central location for connecting grounds from telecommunications equipment, computers, and other data center equipment. Made of copper. Kits include ground bar with two mounting brackets, an assortment of connectors, and a tube of antioxidant.

Bulletin: DBG

Standard Product

Catalog Number	Bar Size in./mm	No. of 5/16-in. Hole Sets	No. of 7/16-in. Hole Sets
DGTB212	2.00 x 12.00 x .25 51 x 305 x 6	6	3
DGTB216	2.00 x 16.00 x .25 51 x 406 x 6	8	3
DGTB412	4.00 x 12.00 x .25 102 x 305 x 6	12	6
DGTB420	4.00 x 20.00 x .25 102 x 508 x 6	24	6

2-in wide bar

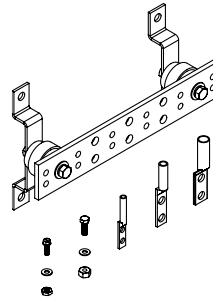

4-in wide bar

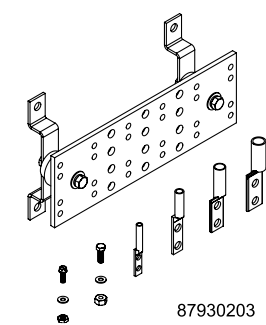

87930203

Number and Style of Compression Lugs Included with Ground Bar Kits

Catalog Number	#6 Wire Size (DGCL61)	#2 Wire Size (DGCL22)	#2/0 Wire Size (DGCL201)	#4/0 Wire Size (DGCL402)
DGTB212	6 lugs	3 lugs	1 lug	0
DGTB216	6 lugs	3 lugs	1 lug	0
DGTB412	6 lugs	3 lugs	1 lug	1 lug
DGTB420	6 lugs	3 lugs	1 lug	1 lug

Vertical Ground Bar Kits

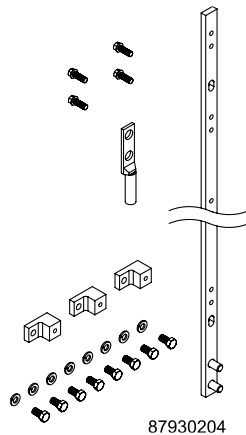

87930204

Mount vertically on rack, providing a convenient place to connect equipment grounds. Made of electrolytic tough-pitch 110 copper alloy. Kits include ground bar with compression lug for #2 wire, connection hardware, and mounting hardware.

Bulletin: DBG

Catalog Number	Bar Size (in.)	Bar Size (mm)
DG36	36.00 x .625 x .25	914 x 16 x 6
DG72	72.00 x .625 x .25	1829 x 16 x 6

Horizontal Ground Bar Kits

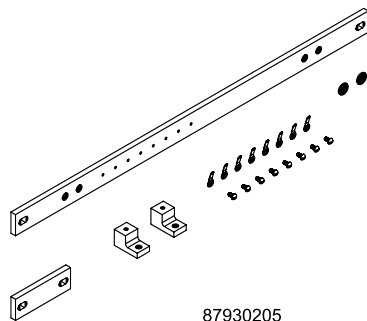

87930205

Mount horizontally on rack, providing a convenient place to connect equipment grounds. Made of electrolytic tough-pitch 110 copper alloy. Kits include ground bar with mounting hardware, eight #6-32 x 14 machine screws, and eight #6 ring terminals.

Bulletin: DBG

Catalog Number	Bar Size (in.)	Bar Size (mm)
DG19	1.00 x 19.25 x .25	25 x 489 x 6
DG23	1.00 x 23.25 x .25	25 x 591 x 6

Bonding and Grounding Accessories

Insulated Ground Jumper Kit

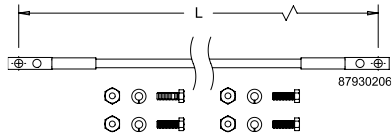

Fastens across splices to provide a secure ground between sections of ladder rack. Made of #6 AWG x 7 strand wire with green THW insulation and two-hole compression lugs mounted on each end. Includes fasteners.

Bulletin: DBG

Catalog Number	Conductor Type	L (in.)	L (mm)
DGJ	#6-7 Stranded	12.00	305

cULus requires 2 kits per splice on all painted ladder sections

Rack Jumper Kit

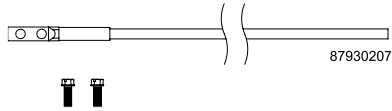

Grounds rack or cabinet to common bonding network under floor or overhead. Made of #6 AWG x 7 strand wire with green THW insulation and two-hole compression lug mounted on one end. Includes fasteners.

Bulletin: DBG

Catalog Number	Conductor Type	Length (ft.)	Length (m)
DGRJ	#6-7 stranded	9	2.7