

Optocoupler, Phototransistor Output, with Base Connection

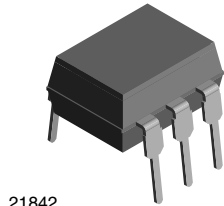

21842

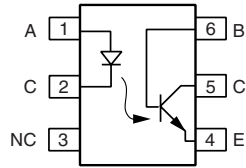

1179004-5

DESCRIPTION

The 4N25 family is an industry standard single channel phototransistor coupler. This family includes the 4N25, 4N26, 4N27, 4N28. Each optocoupler consists of gallium arsenide infrared LED and a silicon NPN phototransistor.

FEATURES

- Isolation test voltage 5000 V_{RMS}
- Interfaces with common logic families
- Input-output coupling capacitance < 0.5 pF
- Industry standard dual-in-line 6 pin package
- Compliant to RoHS directive 2002/95/EC and in accordance to WEEE 2002/96/EC



RoHS
COMPLIANT

APPLICATIONS

- AC mains detection
- Reed relay driving
- Switch mode power supply feedback
- Telephone ring detection
- Logic ground isolation
- Logic coupling with high frequency noise rejection

AGENCY APPROVALS

- UL1577, file no. E52744
- BSI: EN 60065:2002, EN 60950:2000
- FIMKO: EN 60950, EN 60065, EN 60335

ORDER INFORMATION

PART	REMARKS
4N25	CTR > 20 %, DIP-6
4N26	CTR > 20 %, DIP-6
4N27	CTR > 10 %, DIP-6
4N28	CTR > 10 %, DIP-6

ABSOLUTE MAXIMUM RATINGS (1)

PARAMETER	TEST CONDITION	SYMBOL	VALUE	UNIT
INPUT				
Reverse voltage		V _R	5	V
Forward current		I _F	60	mA
Surge current	t ≤ 10 μs	I _{FSM}	3	A
Power dissipation		P _{diss}	100	mW
OUTPUT				
Collector emitter breakdown voltage		V _{CEO}	70	V
Emitter base breakdown voltage		V _{EBO}	7	V
Collector current		I _C	50	mA
	t ≤ 1 ms	I _C	100	mA
Power dissipation		P _{diss}	150	mW



ABSOLUTE MAXIMUM RATINGS ⁽¹⁾				
PARAMETER	TEST CONDITION	SYMBOL	VALUE	UNIT
COUPLER				
Isolation test voltage		V _{ISO}	5000	V _{RMS}
Creepage distance			≥ 7	mm
Clearance distance			≥ 7	mm
Isolation thickness between emitter and detector			≥ 0.4	mm
Comparative tracking index	DIN IEC 112/VDE 0303, part 1		175	
Isolation resistance	V _{IO} = 500 V, T _{amb} = 25 °C	R _{IO}	10 ¹²	Ω
	V _{IO} = 500 V, T _{amb} = 100 °C	R _{IO}	10 ¹¹	Ω
Storage temperature		T _{stg}	- 55 to + 125	°C
Operating temperature		T _{amb}	- 55 to + 100	°C
Junction temperature		T _j	125	°C
Soldering temperature ⁽²⁾	max.10 s dip soldering: distance to seating plane ≥ 1.5 mm	T _{slid}	260	°C

Notes

⁽¹⁾ T_{amb} = 25 °C, unless otherwise specified.

Stresses in excess of the absolute maximum ratings can cause permanent damage to the device. Functional operation of the device is not implied at these or any other conditions in excess of those given in the operational sections of this document. Exposure to absolute maximum ratings for extended periods of the time can adversely affect reliability.

⁽²⁾ Refer to reflow profile for soldering conditions for surface mounted devices (SMD). Refer to wave profile for soldering conditions for through hole devices (DIP).

ELECTRICAL CHARACTERISTICS ⁽¹⁾							
PARAMETER	TEST CONDITION	PART	SYMBOL	MIN.	TYP.	MAX.	UNIT
INPUT							
Forward voltage ⁽²⁾	I _F = 50 mA		V _F		1.3	1.5	V
Reverse current ⁽²⁾	V _R = 3 V		I _R		0.1	100	μA
Capacitance	V _R = 0 V		C _O		25		pF
OUTPUT							
Collector base breakdown voltage ⁽²⁾	I _C = 100 μA		BV _{CBO}	70			V
Collector emitter breakdown voltage ⁽²⁾	I _C = 1 mA		BV _{CEO}	30			V
Emitter collector breakdown voltage ⁽²⁾	I _E = 100 μA		BV _{ECO}	7			V
I _{CEO} (dark) ⁽²⁾	V _{CE} = 10 V, (base open)	4N25			5	50	nA
		4N26			5	50	nA
		4N27			5	50	nA
		4N28			10	100	nA
I _{CBO} (dark) ⁽²⁾	V _{CB} = 10 V, (emitter open)				2	20	nA
Collector emitter capacitance	V _{CE} = 0		C _{CE}		6		pF
COUPLER							
Isolation test voltage ⁽²⁾	Peak, 60 Hz		V _{IO}	5000			V
Saturation voltage, collector emitter	I _{CE} = 2 mA, I _F = 50 mA		V _{CE(sat)}			0.5	V
Resistance, input output ⁽²⁾	V _{IO} = 500 V		R _{IO}	100			GΩ
Capacitance, input output	f = 1 MHz		C _{IO}		0.6		pF

Notes

⁽¹⁾ T_{amb} = 25 °C, unless otherwise specified.

Minimum and maximum values are testing requirements. Typical values are characteristics of the device and are the result of engineering evaluation. Typical values are for information only and are not part of the testing requirements.

⁽²⁾ JEDEC registered values are 2500 V, 1500 V, 1500 V, and 500 V for the 4N25, 4N26, 4N27, and 4N28 respectively.

CURRENT TRANSFER RATIO (1)							
PARAMETER	TEST CONDITION	PART	SYMBOL	MIN.	TYP.	MAX.	UNIT
DC current transfer ratio	$V_{CE} = 10\text{ V}$, $I_F = 10\text{ mA}$	4N25	CTR_{DC}	20	50		%
		4N26	CTR_{DC}	20	50		%
		4N27	CTR_{DC}	10	30		%
		4N28	CTR_{DC}	10	30		%

Note

(1) Indicates JEDEC registered values.

SWITCHING CHARACTERISTICS							
PARAMETER	TEST CONDITION	SYMBOL	MIN.	TYP.	MAX.	UNIT	
Rise and fall times	$V_{CE} = 10\text{ V}$, $I_F = 10\text{ mA}$, $R_L = 100\ \Omega$	t_r , t_f		2		μs	

TYPICAL CHARACTERISTICS

$T_{amb} = 25\text{ }^\circ\text{C}$, unless otherwise specified

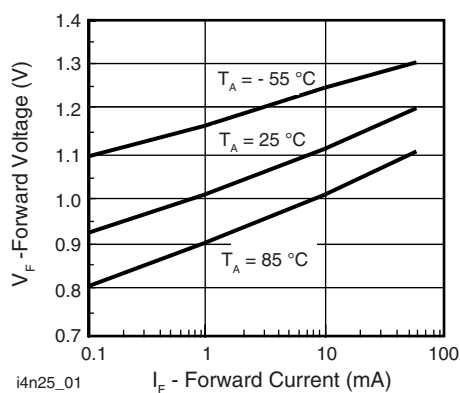

Fig. 1 - Forward Voltage vs. Forward Current

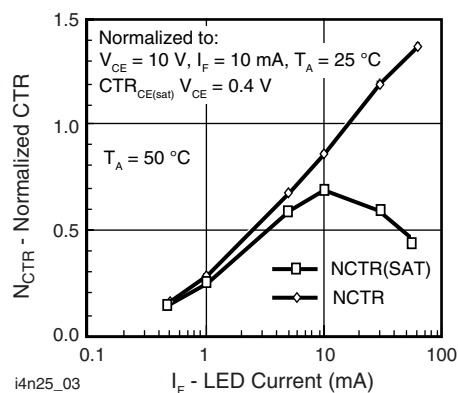

Fig. 3 - Normalized Non-Saturated and Saturated CTR vs. LED Current

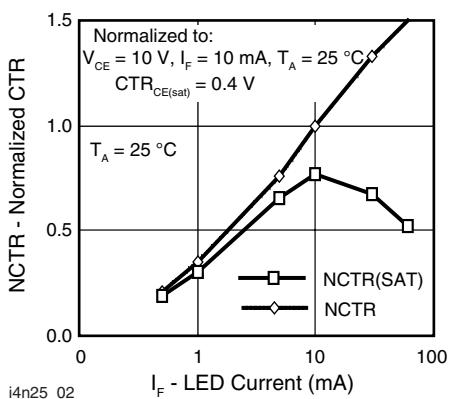

Fig. 2 - Normalized Non-Saturated and Saturated CTR vs. LED Current

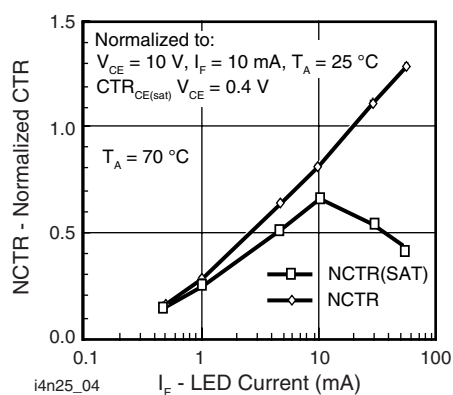

Fig. 4 - Normalized Non-Saturated and Saturated CTR vs. LED Current

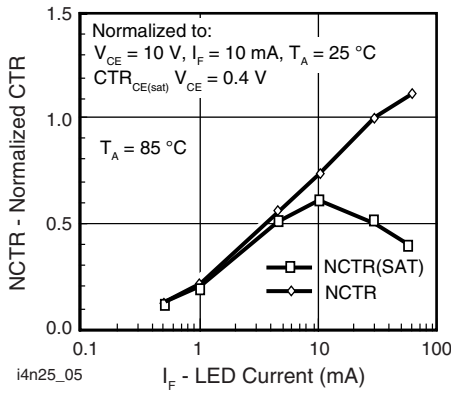

Fig. 5 - Normalized Non-Saturated and Saturated CTR vs. LED Current

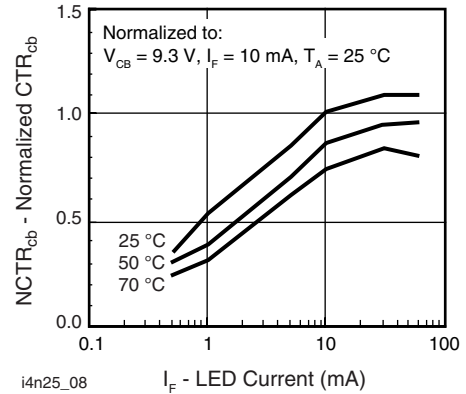

Fig. 8 - Normalized CTR_{cb} vs. LED Current and Temperature

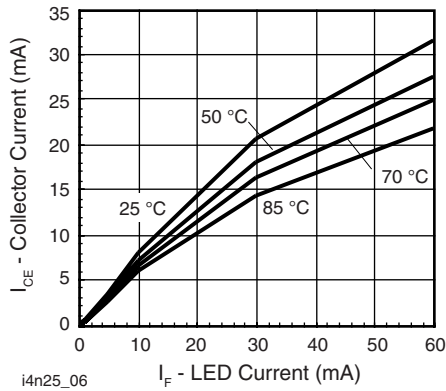

Fig. 6 - Collector Emitter Current vs. Temperature and LED Current

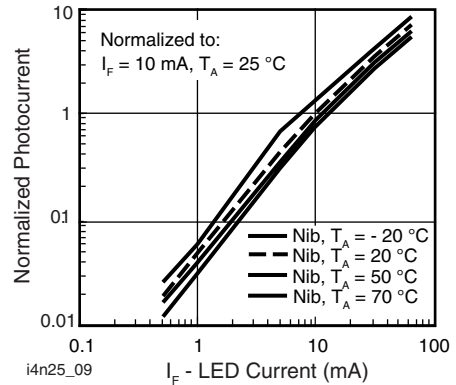

Fig. 9 - Normalized Photocurrent vs. I_F and Temperature

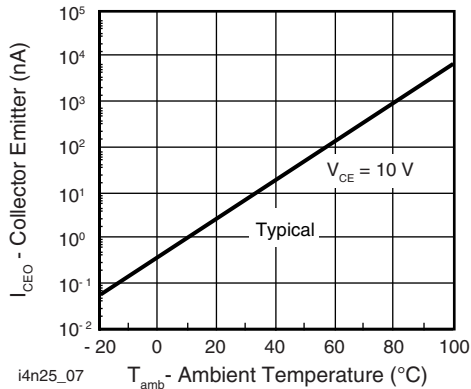

Fig. 7 - Collector Emitter Leakage Current vs. Temperature

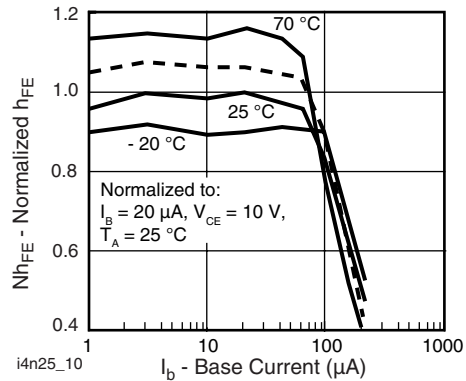

Fig. 10 - Normalized Non-Saturated h_{FE} vs. Base Current and Temperature

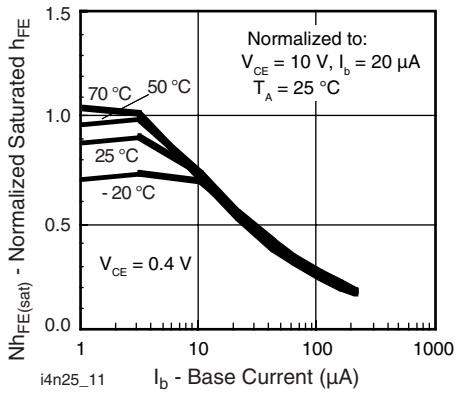

Fig. 11 - Normalized h_{FE} vs. Base Current and Temperature

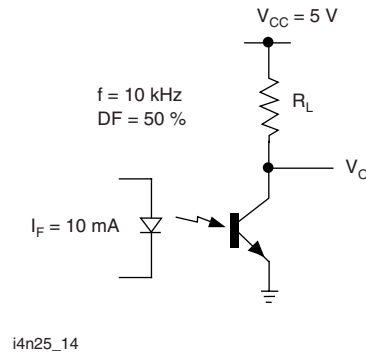

Fig. 14 - Switching Schematic

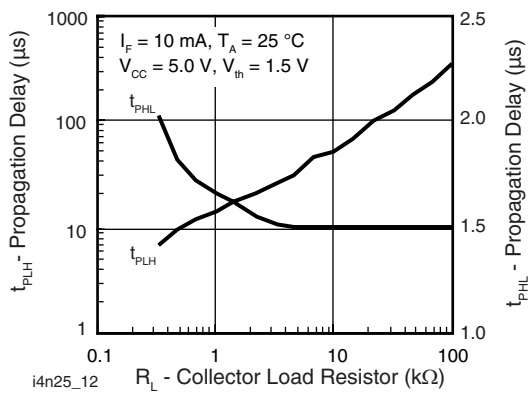

Fig. 12 - Propagation Delay vs. Collector Load Resistor

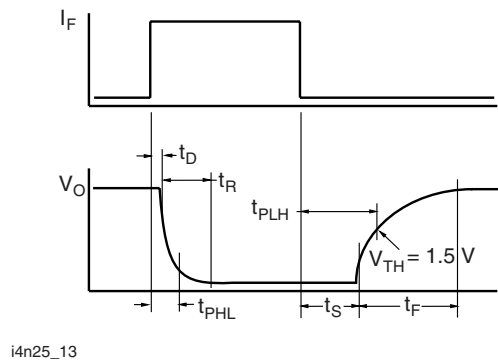

Fig. 13 - Switching Timing



4N25, 4N26, 4N27, 4N28

Optocoupler, Phototransistor Output, Vishay Semiconductors
with Base Connection

PACKAGE DIMENSIONS in millimeters

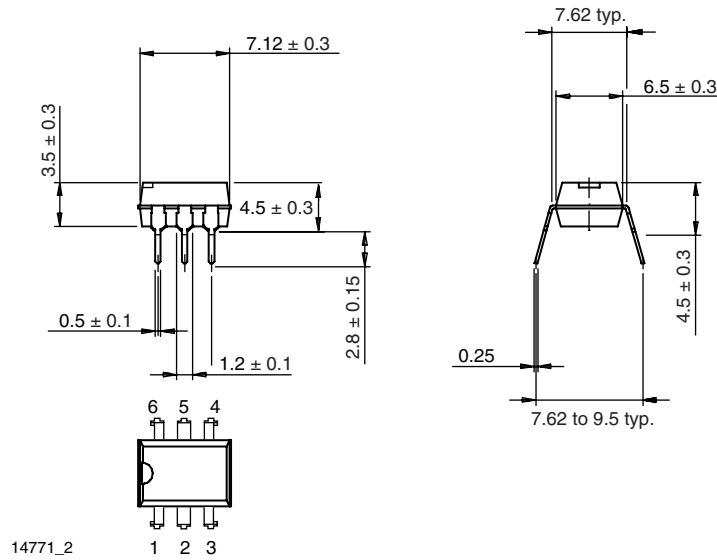

PACKAGE MARKING

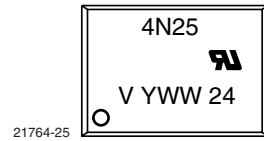



Disclaimer

All product specifications and data are subject to change without notice.

Vishay Intertechnology, Inc., its affiliates, agents, and employees, and all persons acting on its or their behalf (collectively, "Vishay"), disclaim any and all liability for any errors, inaccuracies or incompleteness contained herein or in any other disclosure relating to any product.

Vishay disclaims any and all liability arising out of the use or application of any product described herein or of any information provided herein to the maximum extent permitted by law. The product specifications do not expand or otherwise modify Vishay's terms and conditions of purchase, including but not limited to the warranty expressed therein, which apply to these products.

No license, express or implied, by estoppel or otherwise, to any intellectual property rights is granted by this document or by any conduct of Vishay.

The products shown herein are not designed for use in medical, life-saving, or life-sustaining applications unless otherwise expressly indicated. Customers using or selling Vishay products not expressly indicated for use in such applications do so entirely at their own risk and agree to fully indemnify Vishay for any damages arising or resulting from such use or sale. Please contact authorized Vishay personnel to obtain written terms and conditions regarding products designed for such applications.

Product names and markings noted herein may be trademarks of their respective owners.