

10250H Series, Renewal Parts

Renewal Parts

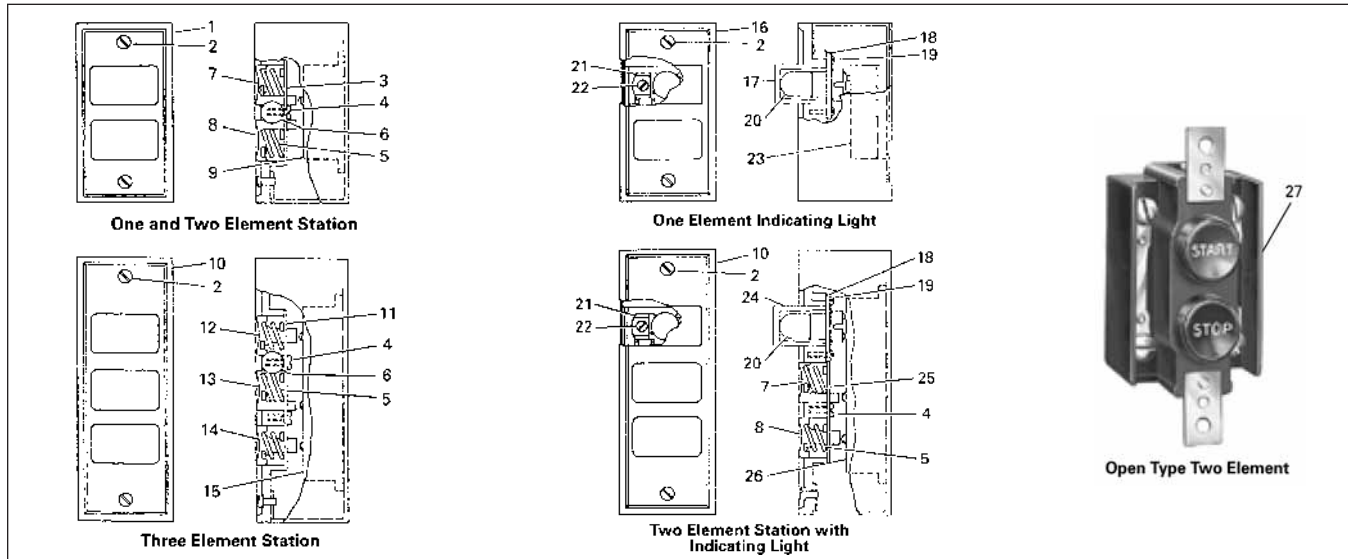

Figure 47-14. Type N Renewal Parts

Table 47-27. Assembled Stations — Type N Renewal Parts

Item No.	Description	No. Req.	Part Number	Price U.S. \$
Type N — Square Buttons				
1	Cover 2 Element Single Element — Top Button Single Element — Bottom Button	1	49-3524 49-3524-2 49-3524-3	
2	Cover Screw	2	11-2168	
3	Pushbutton Support Bracket	1	79-6649	
4	Pushbutton Support Bracket Screw	1	11-2090	
5	Pushbutton Spring	2	69-2571	
6	Disc (when used — 2 element assembly)	2	16-1960	
7	Pushbutton — Top Position START/Green RAISE/Black FORWARD/Black OPEN/Black UP/Black Blank/Green	1	53-1169-3 53-1169-66 53-1169-7 53-1169-9 53-1169-11 53-1169	
8	Pushbutton — Bottom Position STOP/Red Extended STOP/Red REVERSE/Black CLOSE/Black DOWN/Black LOWER/Black Blank/Red	1	53-1202-2 53-1202-5 53-1169-8 53-1169-10 53-1169-12 53-1169-6 53-1202	
9	Pushbutton Element 1NO-1NC 2NO 1NO 1NC	1	86-2588 86-2588-2 86-2588-3 86-2588-4	
10	Cover	1	49-3464	
11	Pushbutton Support Bracket	1	79-6650	
12	Pushbutton — Top Position FORWARD/Black UP/Black RAISE/Black OPEN/Black FAST/Black	1	53-1170-7 53-1170-4 53-1170-5 53-1170-9 53-1170-6	







Item No.	Description	No. Req.	Part Number	Price U.S. \$
Type N — Square Buttons (Continued)				
13	Pushbutton Middle Position REVERSE/Black DOWN/Black LOWER/Black CLOSE/Black SLOW/Black	1	53-1169-15 53-1169-18 53-1169-16 53-1169-17 53-1169-13	
14	Pushbutton — Bottom Position STOP/Red	1	53-1201-2	
15	Pushbutton Element 2NO-3NC	1	86-2593	
16	Cover	1	49-3524-4	
17	Lens Clear Red Amber	1	28-494 28-887-2 28-887-3	
18	Shield	1	73-1337	
19	Shield Screws	4	11-2012	
20	Lamp (Neon NE48)	1	28-494	
21	Lamp Receptacle	1	28-902	
22	Lamp Receptacle Screw	1	911-330F1	
23	Pilot Light Terminal Base	1	86-2586	
24	Lens Clear Red Amber	1	28-887 28-887-2 28-887-3	
25	Pushbutton Support Bracket	1	79-6650-2	
26	Pushbutton Element 1NO-1NC	1	86-2594	
Type N — Round Buttons				
Similar to 27	Pushbutton Assembly and Element for: 10250H289 10250H364 10250H685 10250H665 10250H671 10250H2738 10250H2740 10250H2741 10250H2742	1 1 1 1 1 1 1 1 1	10250H2538 86-353 86-353-8 86-353-8 86-353 86-353-3 86-356 86-356 86-356	

Discount Symbol 1CD1C

47

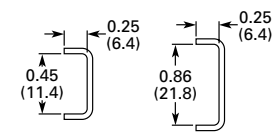
E34 Series, Accessories

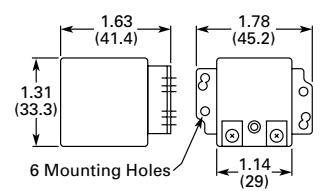
Table 47-308. Accessories (Continued)

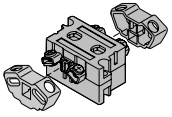
Description	Catalog Number	Price U.S. \$	Overall Dimensions in Inches (mm)
 Thrust Washer — To meet Ford Motor Company mounting specifications.	E34TK3		
 Contact Block Terminal Jumps — Available in multiples of 100 only. Term. to Term. — Within Block (short): 100 per package 1000 per package Terminal to Terminal — Block to Block (long): 100 per package 1000 per package	10250TA70 10250TA70-2 10250TA71 10250TA71-2		 0.25 (6.4) 0.45 (11.4) 0.86 (21.8)
 Master Test (Dual Input) Module — Internal Form C relay suitable for either AC or DC applications. Total electrical isolation between monitored and test circuit. Fits all illuminated 10250T, E22, E30 and E34 devices. 48V DC	10250TMT8		 1.63 (41.4) 1.78 (45.2) 1.31 (33.3) 1.14 (29) 6 Mounting Holes
 Flasher Module — Internal Form C relay suitable for AC applications. One unit required for each operator in master test circuit. 24V AC 120V AC	10250TFL2 10250TFL1		
 Panel Mounting Nut Wrench — E22, E30, E34 and Octagonal 10250T.	E22CW		
 Fingerproof Shroud — 10 per Package Fits new style contact blocks and light units.	10250TA101		

47









Table 47-309. Replacement Lamps — For E34 Illuminated Operators

Mfg. Lamp Type	Voltage	Base Style	Application	Part Number	Price U.S. \$
120MB	120V	T 3-1/4 Bayonet	10250T Resistor Indicating Light	28-3044	
#267	6.3V	T 3-1/4 Bayonet	10250T Flasher	10250ED986-4	
#755	6.3V	T 3-1/4 Bayonet	10250T Transformer, PresTest and Full Voltage		
#756	12V	T 3-1/4 Bayonet	10250T Full Voltage		
#757	24V	T 3-1/4 Bayonet	10250T Full Voltage		
#1828	32V	T 3-1/4 Bayonet	10250T Full Voltage	28-5186	
#1835	55V	T 3-1/4 Bayonet	10250T Resistor	28-5187	
NE48	120V	T 4-1/2 Bayonet	10250T Neon	28-494	
NE51H-R22	120V	T 3-1/4 Bayonet	10250T Neon	28-3754	
NE51H-R68	240V	T 3-1/4 Bayonet	10250T Neon	28-3755	

Discount Symbol **1CD1C**

10250T Series, Accessories

Table 47-250. Accessories (Continued)

Description	Catalog Number	Price U.S. \$
Hardware and Kits (Continued)		
 Base Mounting Spacers ① — Equivalent to contact block in depth — Complete with screws, washers, etc.	1 Block Deep 2 Block Deep	10250TA22 10250TA23
 Grounding Kits — Kits consist of a ring connector and a #6 screw for mounting connector to rear of contact block mounting screw.		10250TKG1
 Contact Block Terminal Jumpers — Available in multiples of 100 only. Term. to Term. — within Block (short) 100 per pkg. 1000 per pkg. Term. to Term. — Block to Block (long) 100 per pkg. 1000 per pkg.		10250TKG2 ② 10250TKG3 ②
 Contact Block Terminal Jumpers — Available in multiples of 100 only. Term. to Term. — within Block (short) 100 per pkg. 1000 per pkg. Term. to Term. — Block to Block (long) 100 per pkg. 1000 per pkg.		10250TA70 10250TA70-2 10250TA71 10250TA71-2
Special Operators and Attachments		
 Wobble Stick Complete with retaining nut — fits standard button.		10250TA5
 Lever Operator For use with two vertically mounted flush pushbuttons.		10250TA14
 Maintained Contact Attachment Release Button Assembly ② Mechanically interlocks with another pushbutton and contact block (not included). Provides mode indication. Minimum hole centers 1.62 inch (41.1 mm), maximum 2.313 inch (58.8 mm). Black Red Green Yellow Same with Long Button — Black		10250TA17 10250TA18 10250TA19 10250TA20 10250TA39
 Maintained Contact Attachment ② Mechanically interlocks two buttons and provides position indication for one. Use with two pushbutton operators and one or more contact blocks.		10250TA1
 Roto-Push Lever Operator — Used to provide lever operation for Roto-Push operators.		10250TA13

47

Description	Catalog Number	Price U.S. \$
Special Light Modules		
 Master Test (Dual Input) Module — Internal Form C relay suitable for either AC or DC applications. Total electrical isolation between monitored and test circuit. Fits all illuminated 10250T, E22, E30 and E34 devices. 48V DC		10250TMT8
 Flasher Module — Changes any AC illuminated device to a controlled flashing light. Fits 10250T, E30 and E34 devices. 24V 120V		10250TFL2 10250TFL1
 Flashing Incandescent Lamp — For use with 120V transformer type or 6V full voltage type Indicating Lights including PresTest and most E29 devices.		10250ED986-4
Hole Plugs		
 Plug — For unused holes — Steel, painted gray (Stainless steel, use E30KT5, see Page 47-112)		10250TA7
Tools		
 Octagonal 10250T (notched to fit over selector switch lever), E29 and E30		10250TA95
 E22, E30, E34 and Octagonal 10250T (will not fit over selector switch levers)		E22CW
 Tool for Tightening Boots — Used to install boot Catalog Numbers, 10250TA3, A4, A10 and A25.		10250TA96
 10250T, E34 Allen Wrench — Used for removal of jumbo mushroom head.		10250TA102
 Lamp Removal Tools — For transformer type illuminated pushbuttons, push-pull and selector switches. Fits #12 lamp.		10250TA74
 For full voltage and resistor type illuminated pushbuttons, push-pull and selector switches and E30.		E30KV1
 Standard indicating lights. Fits #44, #755, #6S6 and #10S6.		E29KLT

① Component only. Not to be used for custom built (factory assembled) stations.
 ② Not suitable for single contact block depth cast enclosure. Cover is too thick.

Dimensions **Pages 47-160 – 47-162**
 Discount Symbol **1CD1C**

Renewal Parts

Table 47-251. Replacement Lamps — For 10250T Illuminated Operators

Mfg. Lamp Type	Voltage	Base Style	Application	Part Number	Price U.S. \$
120MB	120V	T 3-1/4 Bayonet	10250T Resistor Indicating Light	28-3044	
#267	6.3V	T 3-1/4 Bayonet	10250T Flasher	10250ED986-4	
#755	6.3V	T 3-1/4 Bayonet	10250T Transformer, PresTest and Full Voltage		
#756	12V	T 3-1/4 Bayonet	10250T Full Voltage		
#757	24V	T 3-1/4 Bayonet	10250T Full Voltage		
#1828	32V	T 3-1/4 Bayonet	10250T Full Voltage	28-5186	
#1835	55V	T 3-1/4 Bayonet	10250T Resistor	28-5187	
NE48	120V	T 4-1/2 Bayonet	10250T Neon	28-494	
NE51H-R22	120V	T 3-1/4 Bayonet	10250T Neon	28-3754	
NE51H-R68	240V	T 3-1/4 Bayonet	10250T Neon	28-3755	

Table 47-252. Replacement LED Lamps — For 10250T, E34 and E22 Units

	Voltage	Color	Continuous		Flashing		
			AC/DC	Price U.S. \$	AC	DC	Price U.S. \$
			Catalog Number		Catalog Number	Catalog Number	
 <p>Standard LED Lamp</p>	6V – 12V	Red Orange Yellow Green Blue White	E22LED612RN E22LED612ON E22LED612YN E22LED612GN E22LED612BN E22LED612WN		E22LED006RAF E22LED006OAF E22LED006YAF E22LED006GAF E22LED006BAF E22LED006WAF	E22LED006RDF E22LED006ODF E22LED006YDF E22LED006GDF E22LED006BDF E22LED006WDF	
	24V	Red Orange Yellow Green Blue White	E22LED024RN E22LED024ON E22LED024YN E22LED024GN E22LED024BN E22LED024WN		E22LED024RAF E22LED024OAF E22LED024YAF E22LED024GAF E22LED024BAF E22LED024WAF	E22LED024RDF E22LED024ODF E22LED024YDF E22LED024GDF E22LED024BDF E22LED024WDF	
	48V	Red Orange Yellow Green Blue White	E22LED048RN E22LED048ON E22LED048YN E22LED048GN E22LED048BN E22LED048WN		E22LED048RAF E22LED048OAF E22LED048YAF E22LED048GAF E22LED048BAF E22LED048WAF	E22LED048RDF E22LED048ODF E22LED048YDF E22LED048GDF E22LED048BDF E22LED048WDF	
	60V	Red Orange Yellow Green Blue White	E22LED060RN E22LED060ON E22LED060YN E22LED060GN E22LED060BN E22LED060WN		E22LED060RAF E22LED060OAF E22LED060YAF E22LED060GAF E22LED060BAF E22LED060WAF	E22LED060RDF E22LED060ODF E22LED060YDF E22LED060GDF E22LED060BDF E22LED060WDF	
	120V	Red Orange Yellow Green Blue White	E22LED120RN E22LED120ON E22LED120YN E22LED120GN E22LED120BN E22LED120WN		E22LED120RAF E22LED120OAF E22LED120YAF E22LED120GAF E22LED120BAF E22LED120WAF	E22LED120RDF E22LED120ODF E22LED120YDF E22LED120GDF E22LED120BDF E22LED120WDF	

E22 and EM22 Series, Illuminated Components

Replacement LEDs and Bulbs — Standard Size

Table 47-101. Replacement LEDs for Indicating Lights, Illuminated Pushbuttons, Illuminated Push-Push Operators and Double-Headed Pushbuttons



	Voltage	Color	Continuous		Flashing		
			AC/DC	Price U.S. \$	AC	DC	Price U.S. \$
			Catalog Number		Catalog Number	Catalog Number	
 Standard LED Lamp	6V – 12V	Red Orange Yellow Green Blue White	E22LED612RN E22LED612ON E22LED612YN E22LED612GN E22LED612BN E22LED612WN		E22LED006RAF E22LED006OAF E22LED006YAF E22LED006GAF E22LED006BAF E22LED006WAF	E22LED006RDF E22LED006ODF E22LED006YDF E22LED006GDF E22LED006BDF E22LED006WDF	
	24V	Red Orange Yellow Green Blue White	E22LED024RN E22LED024ON E22LED024YN E22LED024GN E22LED024BN E22LED024WN		E22LED024RAF E22LED024OAF E22LED024YAF E22LED024GAF E22LED024BAF E22LED024WAF	E22LED024RDF E22LED024ODF E22LED024YDF E22LED024GDF E22LED024BDF E22LED024WDF	
	48V	Red Orange Yellow Green Blue White	E22LED048RN E22LED048ON E22LED048YN E22LED048GN E22LED048BN E22LED048WN		E22LED048RAF E22LED048OAF E22LED048YAF E22LED048GAF E22LED048BAF E22LED048WAF	E22LED048RDF E22LED048ODF E22LED048YDF E22LED048GDF E22LED048BDF E22LED048WDF	
	60V	Red Orange Yellow Green Blue White	E22LED060RN E22LED060ON E22LED060YN E22LED060GN E22LED060BN E22LED060WN		E22LED060RAF E22LED060OAF E22LED060YAF E22LED060GAF E22LED060BAF E22LED060WAF	E22LED060RDF E22LED060ODF E22LED060YDF E22LED060GDF E22LED060BDF E22LED060WDF	
	120V	Red Orange Yellow Green Blue White	E22LED120RN E22LED120ON E22LED120YN E22LED120GN E22LED120BN E22LED120WN		E22LED120RAF E22LED120OAF E22LED120YAF E22LED120GAF E22LED120BAF E22LED120WAF	E22LED120RDF E22LED120ODF E22LED120YDF E22LED120GDF E22LED120BDF E22LED120WDF	

Table 47-102. Replacement Bulbs — T3-1/4 (BA9) Bayonet Base Type for Indicating Lights, Illuminated Pushbuttons, Illuminated Push-Push Operators and Double-Headed Pushbuttons

Description	Mfg. Part Number	Operating Voltage (V)/ Wattage (W)	Catalog Number	Price U.S. \$
 Standard Incandescent Bulb	#755 #756 #1819 W1225 W1226 W1121	6V (0.9W) 12V (1.2W) 24V (1.2W) 48/50V (1.0W) 60V (1.2W) 120V (2.4W)	28-2202 28-5184 28-2468-24 28-2468-19 28-2468-20 28-2468-7	
	Neon ①	NE51H-R22 NE51H-R68	120 (0.3W) 240 (0.6W)	28-3754 28-3755

① Neon bulbs are suitable for use in indicating lights only. Not to be used with any operator.

Note: See Page 47-73 for Replacement LEDs and bulbs for Push-Pulls and selector switches.