

Features

- Super-luminosity LED.
- White SMT package.
- Built in Red, Green, and Blue chips.
- Lead frame package with 6 individual pins.
- Wide viewing angle.
- ESD protection.
- Pb-free.
- RoHS compliant version.



Descriptions

- 120° viewing angle.
- Low power consumption.

Device Selection Guide

Chip			Lens Color
Type	Material	Emitted Color	
R	AlGaInP	Brilliant Red	Water Clear
G	InGaN	Brilliant Green	
B	InGaN	Blue	

Package Outline Dimension and Recommended Soldering Pattern for Reflow Soldering

Unit: mm Tolerance: +/-0.1

Outline Dim.	Soldering Pattern
<p style="text-align: center;">R G B Die1 Die2 Die3 Pin 6 Pin 5 Pin 4 Pin 1 Pin 2 Pin 3 Polarity</p>	
<p>Soldering terminals may shift in the x, y direction.</p>	

Absolute Maximum Ratings (Ta=25°C)

Parameter	Symbol	Rating		Unit
Reverse Voltage	V _R	5		V
Forward Current	I _F	R	30	mA
		G	30	
		B	30	
Peak Forward Current (Duty 1/10 @ 1KHz)	I _{FP}	R	120	mA
		G	110	
		B	110	
Power Dissipation	P _d	R	80	mW
		G	110	
		B	110	
Electrostatic Discharge(HBM)	ESD	2000		V
Operating Temperature	T _{opr}	-40 ~ +85		°C
Storage Temperature	T _{stg}	-40~ +90		°C
Soldering Temperature	T _{sol}	Reflow Soldering : 260 °C for 10 sec. Hand Soldering : 350 °C for 3 sec.		

Electro-Optical Characteristics (Ta=25°C)

Parameter	Symbol	Min.	Typ.	Max.	Unit	Condition	
Luminous Intensity	I _v	R	450	-----	715	mcd	I _F =20mA
		G	715	-----	1420		
		B	225	-----	450		
Viewing Angle	2θ _{1/2}	-----	120	-----	deg	I _F =20mA	
Peak Wavelength	λ _p	R	-----	632	-----	nm	I _F =20mA
		G	-----	518	-----		
		B	-----	468	-----		
Dominant Wavelength	λ _d	R	617.5	-----	633.5	nm	I _F =20mA
		G	523.5	-----	535.5		
		B	466	-----	472		
Spectrum Radiation Bandwidth	Δλ	R	-----	20	-----	nm	I _F =20mA
		G	-----	35	-----		
		B	-----	35	-----		
Forward Voltage	V _F	R	1.75	-----	2.35	V	I _F =20mA
		G	2.75	-----	3.95		
		B	2.75	-----	3.95		
Reverse Current	I _R	R	-----	-----	10	μA	V _R =5V

Specific binning requirements- please contact our home office

Notes:

1. Tolerance of Luminous Intensity ±10%
2. Tolerance of Dominant Wavelength ±1 nm

■ **Luminous Intensity (Iv) Bin:**

Color	Bin Code	Spec. Range
Red	V	450.0-576.0mcd
	W	576.0-738.0mcd
Green	AA	1400.0-1790.0mcd
	AB	1790.0-2290.0mcd
Blue	S2	220.0-282.0mcd
	T	282.0-360.0mcd

■ **Dominant Wavelength (λ_D) Bin:**

Color	Bin Code	Spec. Range
Red	A	615.0-620.0 nm
	B	620.0-625.0 nm
	C	625.0-630.0 nm
Green	A	515.0-520.0 nm
	B	520.0-525.0 nm
	C	525.0-530.0 nm
Blue	A	460.0-465.0 nm
	B	465.0-470.0 nm

■ **Forward Voltage (Vf) Bin:**

Color	Bin Code	Spec. Range
Blue (NB) Green (NG)	G8	2.7-2.9 V
	H7	2.9-3.1 V
	H8	3.1-3.3 V
	J7	3.3-3.5 V
	J8	3.5-3.7 V
	K7	3.7-3.9 V
Red (USD)	-	1.6-2.6 V

Characteristics Curves

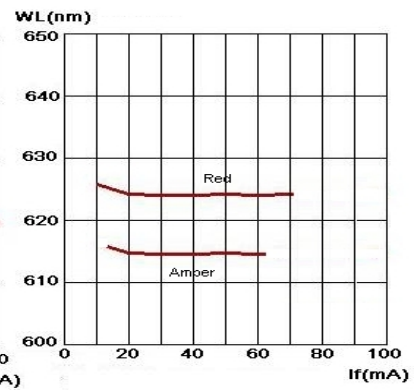
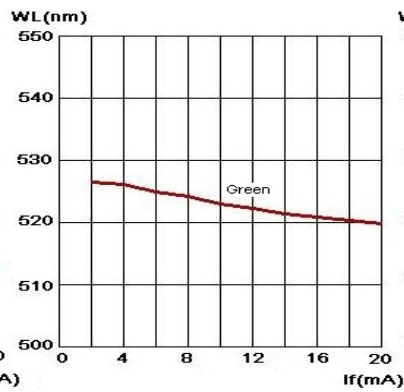
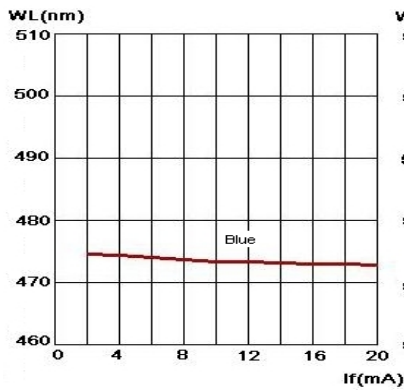
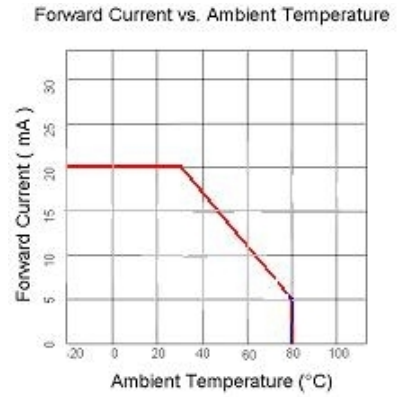
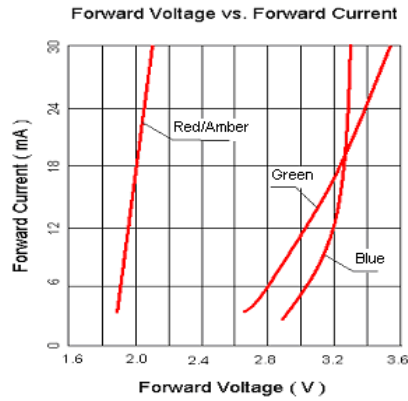
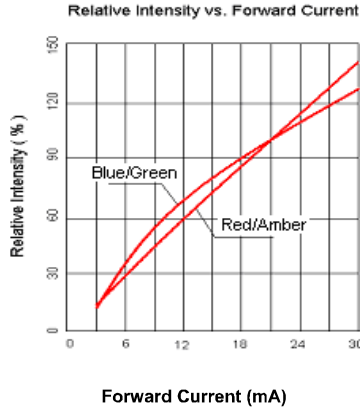

Wavelength vs. Forward Current

Directive Characteristics

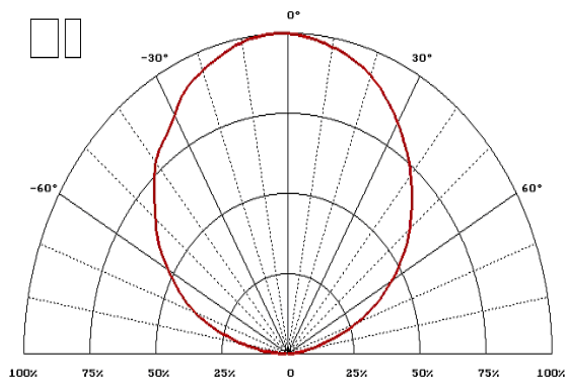

Directive Characteristics

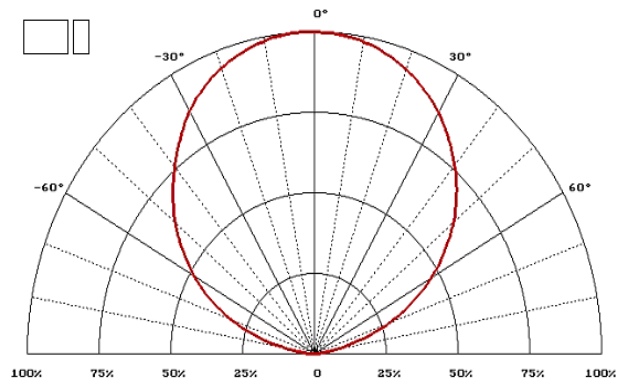

Packaging

Carrier Tape Dimensions: Loaded quantity 1000 PCS per reel.

Tape Dimension

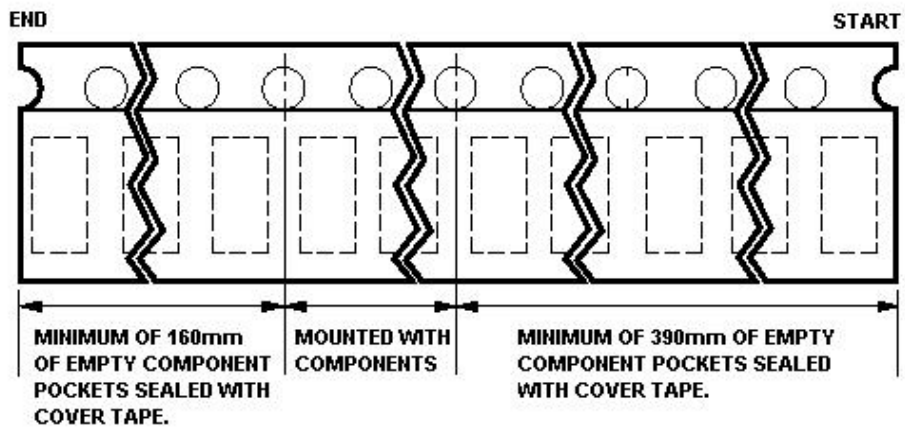
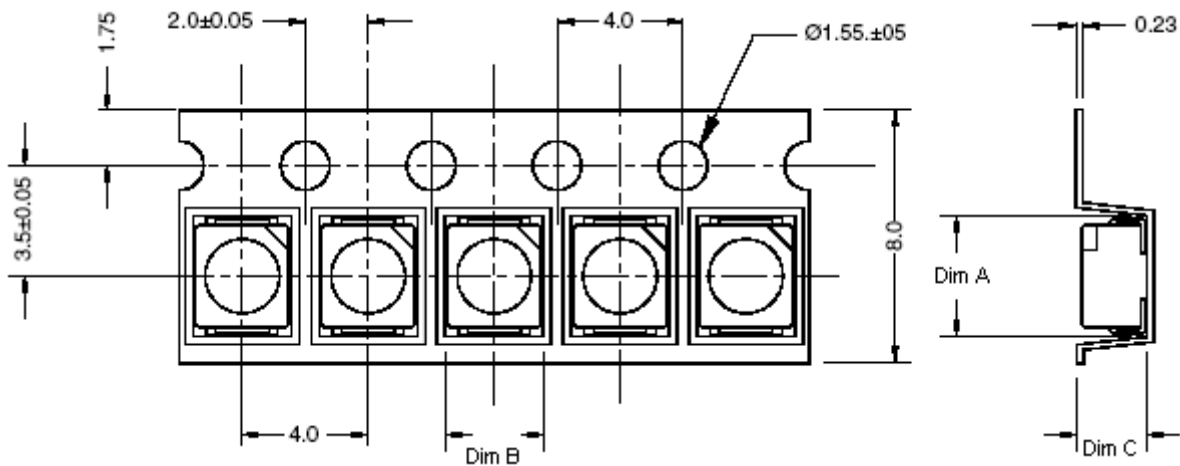

Dry Pack

All SMD optical devices are **MOISTURE SENSITIVE**. Avoid exposure to moisture at all times during transportation or storage. Every reel is packaged in a moisture protected anti-static bag. Each bag is properly sealed prior to shipment.

Upon request, a humidity indicator will be included in the moisture protected anti-static bag prior to shipment.

Moisture Resistant Packaging

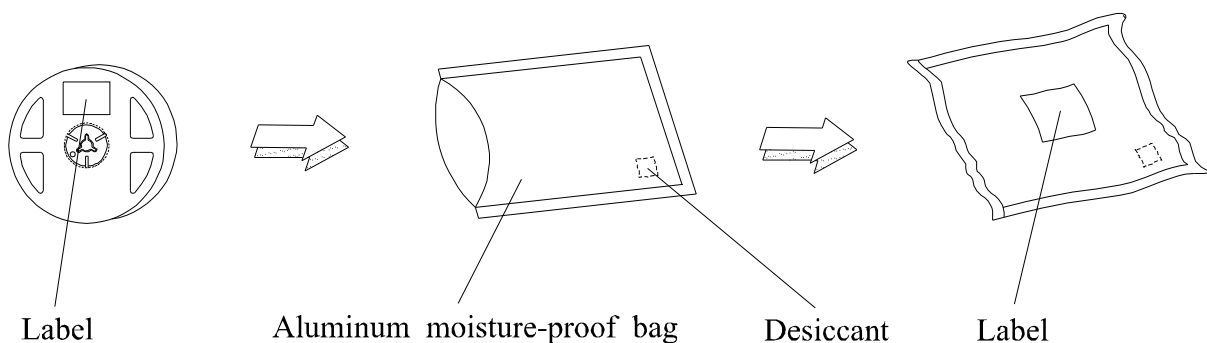

PRECAUTIONS

1. Avoid exposure to moisture at all times during transportation or storage.
2. Anti-Static precaution must be taken when handling GaN, InGaN, and AlInGaP products.
3. It is suggested to connect the unit with a current limiting resistor of the proper size. Avoid applying a reverse voltage beyond the specified limit.
4. Avoid operation beyond the limits as specified by the absolute maximum ratings.

Reflow Soldering

- Recommended tin glue specifications: melting temperature in the range of 178~192 °C
- The recommended reflow soldering profile is as follows (temperatures indicated are as measured on the surface of the LED resin):

Lead Solder Profile

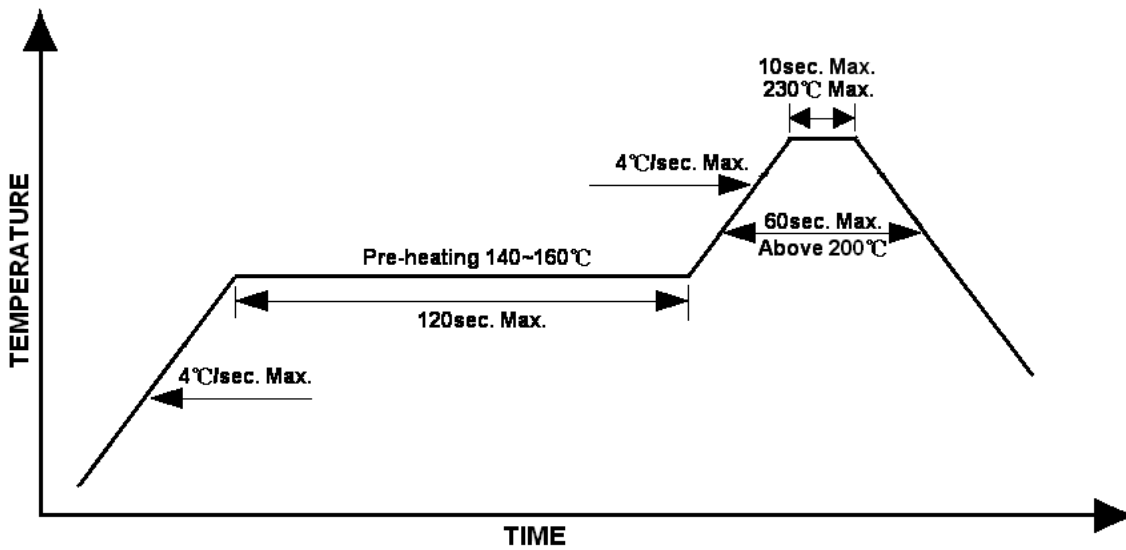

Lead-free Solder Profile

