

# MODEL 301

## Programmable Timer



- Multiple timing & voltage ranges
- Five function modes
- Easy to program
- DPDT Relay Outputs



### DESCRIPTION

The **Model 301 Programmable Timer** is designed to replace over 100 standard timers. One Model 301 can be set for one of five functions, covers four timing ranges, and has a power supply for any AC/DC voltage from 10 to 28 Volts or 40 to 260 Volts. An "SG" version of this model is available using silver with gold flash contacts.

The digital design of the Model 301 provides high accuracy, repeatability and response time. The output of the Model 301 is a heavy-duty DPDT electro-mechanical output relay.

Programming options are chosen by simply setting the four DIP switches on top of the relay, and then adjusting a potentiometer for percent of delay. A LED indicator illuminates when the relay is energized.

The Model 301 can be set to Delay-on-Release by adding an external jumper between pins 6 and 7 (see Installation Instructions on reverse side).

The Model 301 is UL Recognized and CSA Certified.

### UL SPECIFICATIONS\*

Models	301
<b>Input</b>	
Voltage (VAC)	10-28V AC/DC OR 40-260V AC/DC
Power	3 Watts Max
<b>Output</b>	240V AC, 10A, Resistive 120V AC, 4A, General Use 240V AC, 2A, General Use C300, Pilot Duty

\* Pilot Duty:

120V: Make 15A, Break 1.5A  
240V: Make 7.5A, Break 0.75A

### SPECIFICATIONS

MODEL	301
Voltage	L = 10-28V AC/DC H = 40-260V AC/DC
Timing Range	0.15 seconds to 64 minutes
Accuracy	±5%
Repeatability	0.1%
Response time	100ms
Contacts	DPDT
Contact rating	10A at 240VAC resistive
Transient protection	775V, 80 Joules
Expected relay life	Mechanical: 10 million operations Electrical: 100,000 operations at rated load
Operating temperature	-20° to +140° F
Humidity tolerance	0-97% without condensation
Case material	NORYL Plastic
Mounting	11-pin socket (not included)**
Weight	4.5 oz.
Additional Options	/C = Custom (Voltage and/or Timing) /SG = Silver with Gold Flash Contacts

\*\* order 11-pin socket number 51 x 016

**Ordering Examples (Model-Voltage [/Options]):**

**301-H** = Model 301 with a 40-260V AC/DC voltage range

**301-L /SG** = Model 301 with a 10-28V AC/DC voltage range and optional silver with gold flash contacts.

Contact Time Mark to order a custom programmed unit

### PROGRAMMING

TIMING RANGE	SWITCH 1	SWITCH 2
0.15 to 15 seconds	OFF	ON
0.6 to 60 seconds	ON	OFF
5 to 480 seconds	ON	ON
0.6 to 64 minutes	OFF	OFF
FUNCTIONS	SWITCH 3	SWITCH 4
Interval-on-Operate	ON	OFF
Delay-on-Operate	ON	ON
Delay-on-Release	ON	OFF
Recycle Start-ON	OFF	OFF
Recycle Start-OFF	OFF	ON

\* For Delay on Release—See Installation Instructions on reverse side.

Telephone: Main - (918) 438-1220  
Sales - (800) 862-2875  
Fax: (918) 437-7584

E-mail: sales@time-mark.com  
Internet: http://www.time-mark.com



11440 East Pine Street  
Tulsa, Oklahoma 74116

05/2014

© 2014 TIME MARK CORPORATION

TIME MARK is a division of AEMT, Inc.

# MODEL 301

# Programmable Timer

READ ALL INSTRUCTIONS BEFORE INSTALLING, OPERATING OR SERVICING THIS DEVICE.  
KEEP THIS DATA SHEET FOR FUTURE REFERENCE.

## GENERAL SAFETY

POTENTIALLY HAZARDOUS VOLTAGES ARE PRESENT AT THE TERMINALS OF THE MODEL 301.  
ALL ELECTRICAL POWER SHOULD BE REMOVED WHEN CONNECTING OR DISCONNECTING WIRING.  
THIS DEVICE SHOULD BE INSTALLED AND SERVICED BY QUALIFIED PERSONNEL.

## Installation Instructions

### INSTALLATION

1. Mount the 11-pin socket in a suitable enclosure.
2. Referring to the **PROGRAMMING table** on the reverse side of this sheet and **PIN CONNECTIONS** diagram below, set the DIP switches for desired function and timing range.
3. Connect the load to the appropriate relay output terminals of the socket.
4. **For the Delay-on-Release function**, install a normally open switch on terminals 5 and 6 of the socket and add an external jumper between pins 6 and 7 (shown as a dashed line in Pin Connections diagram below)..
5. Connect the appropriate operating power to terminals 10 and 2.

### PIN CONNECTIONS

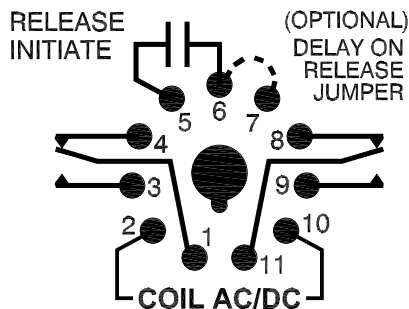

An LED on top of the unit provides a quick visual indicator of the relay's status.

LED Indicator	Unit Status
Green	Energized
Red	De-energized
Flashing (Green or Red)	Relay is Timing

### FUNCTION DESCRIPTIONS

**Interval-on-Operate:** The output relay energizes when operating power is applied. When the timing period elapses, the relay de-energizes. The timer is reset by removing and reapplying power.

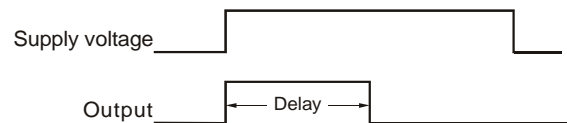

**Delay-on-Operate:** The delay period begins when operating power is applied. When the timing period elapses, the output relay energizes. The timer is reset and restarted by removing and reapplying power.

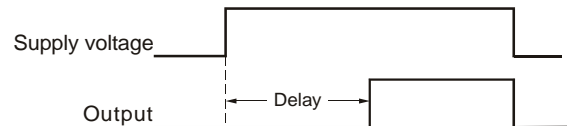

**Delay-on-Release:** Operating power is continuously applied to the timer. When the external release initiate switch is closed the output relay energizes. When the control switch is opened the timing period begins. If the control switch closes before the timing period elapses, the output relay remains energized and the timing period is reset. When the timing period elapses, the output relay de-energizes. The timer is restarted by re-closing the control switch.

For the Delay on Release function, you must add an external jumper between pins 6 and 7.

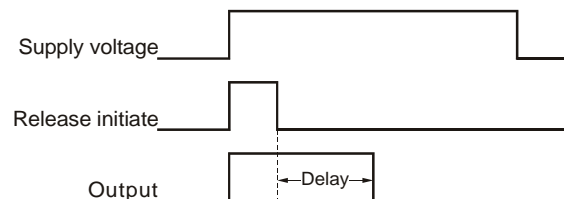

Telephone: Main - (918) 438-1220

Sales - (800) 862-2875

Fax: (918) 437-7584

E-mail: sales@time-mark.com

Internet: http://www.time-mark.com

**SIGNALINE**  
DIV OF TIME MARK CORPORATION

11440 East Pine Street  
Tulsa, Oklahoma 74116

Page 2 of 3 05/2014  
© 2014 TIME MARK CORPORATION

TIME MARK is a division of  AEMT, Inc.

# MODEL 301

# Programmable Timer

READ ALL INSTRUCTIONS BEFORE INSTALLING, OPERATING OR SERVICING THIS DEVICE.  
KEEP THIS DATA SHEET FOR FUTURE REFERENCE.

## GENERAL SAFETY

POTENTIALLY HAZARDOUS VOLTAGES ARE PRESENT AT THE TERMINALS OF THE MODEL 301.  
ALL ELECTRICAL POWER SHOULD BE REMOVED WHEN CONNECTING OR DISCONNECTING WIRING.  
THIS DEVICE SHOULD BE INSTALLED AND SERVICED BY QUALIFIED PERSONNEL.

## Installation Instructions

**Recycle Start-ON:** Operating power is continuously applied to the timer. When operating power is applied, the ON delay period begins. When the ON delay period elapses, the output relay de-energizes, and the OFF delay period begins. This cycle repeats until operating power is removed.

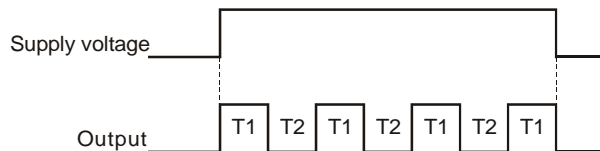

**Recycle Start-OFF** - Operating power is continuously applied to the timer. When operating power is applied, the OFF delay period begins. When the OFF delay period elapses, the output relay energizes, and the ON delay period begins. This cycle repeats until operating power is removed.

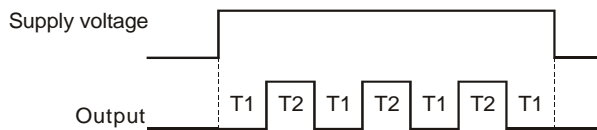

**NOTE:** For recycle timing ON and Off times are equal.

## DIMENSIONS

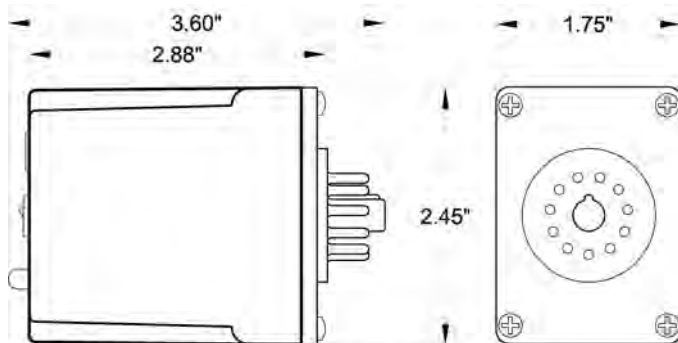

(dimensions have a tolerance of  $\pm 0.06$ )

Shows No Power Applied

## WARRANTY

This product is warranted to be free from defects in materials and workmanship, and is covered by our exclusive **5-year Unconditional Warranty**. Should this device fail to operate for any reason, we will repair it for five years from the date of manufacture. For complete warranty details, see the *Terms and Conditions of Sales* page in the front section of the Time Mark catalog or contact Time Mark at 1-800-862-2875.

Telephone: Main - (918) 438-1220  
Sales - (800) 862-2875  
Fax: (918) 437-7584  
E-mail: sales@time-mark.com  
Internet: http://www.time-mark.com

**SIGNALINE**  
DIV OF TIME MARK CORPORATION

11440 East Pine Street  
Tulsa, Oklahoma 74116

Page 3 of 3 05/2014  
© 2014 TIME MARK CORPORATION

TIME MARK is a division of  AEMT, Inc.

**Have Questions? Call us at (800) 862-2875 and talk to a real live person.**

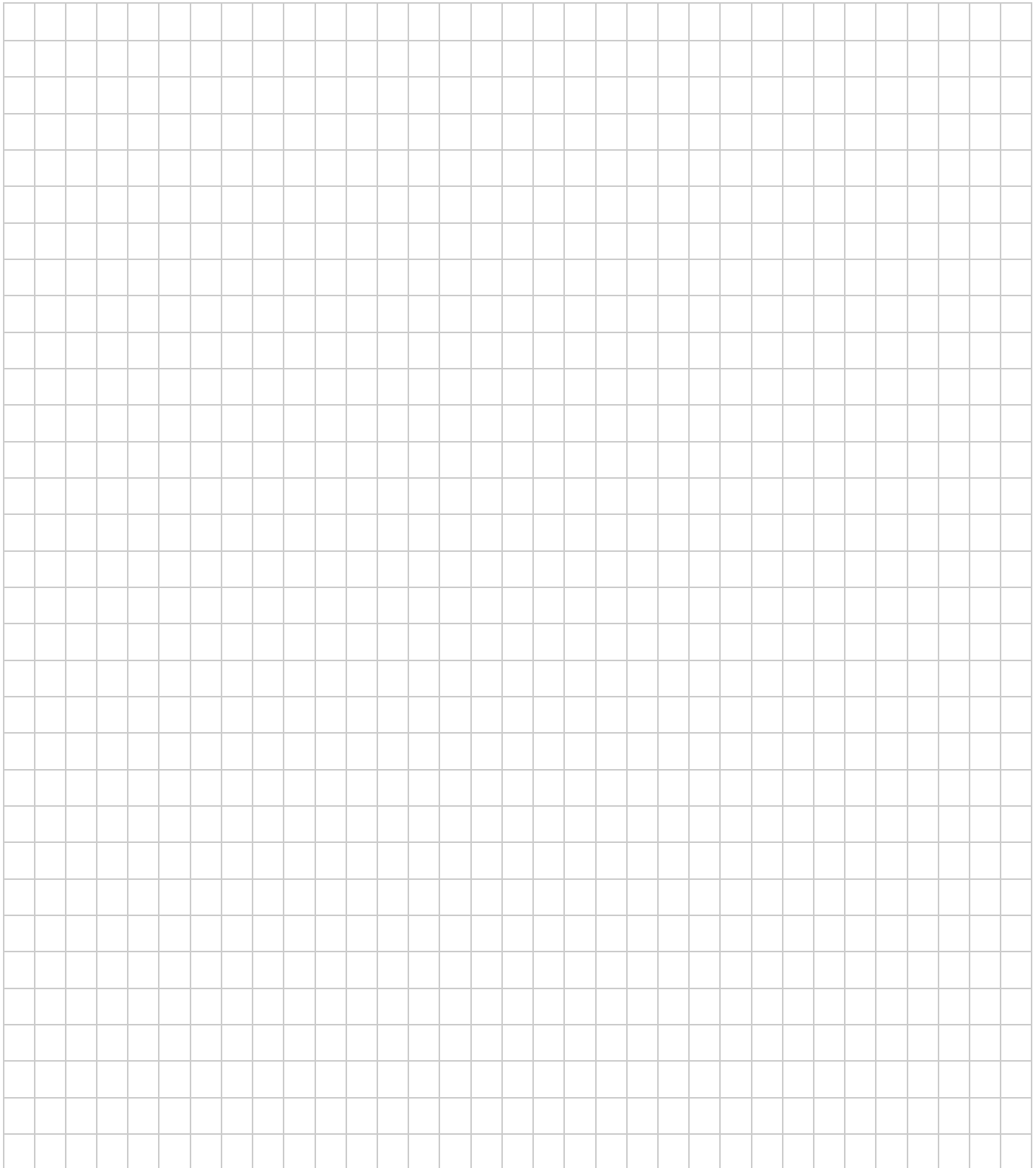

---

Telephone: Main - (918) 438-1220  
Sales - (800) 862-2875  
Fax: (918) 437-7584  
E-mail: [sales@time-mark.com](mailto:sales@time-mark.com)  
Internet: <http://www.time-mark.com>



11440 East Pine Street  
Tulsa, Oklahoma 74116  
05/2014  
© 2014 TIME MARK CORPORATION  
TIME MARK is a division of  AEMT, Inc.