

ELECTRONICS

**CAROL
BRAND**

**ELECTRONICS
WIRE & CABLE**

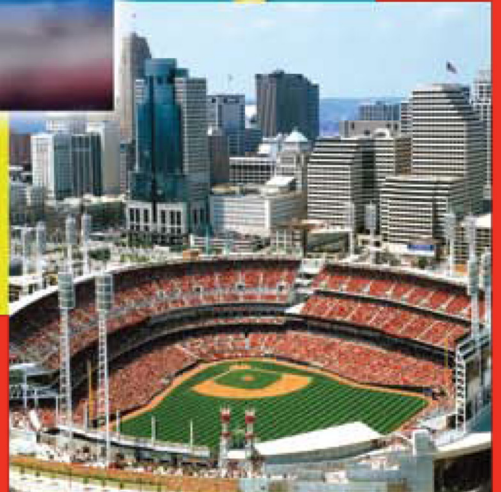
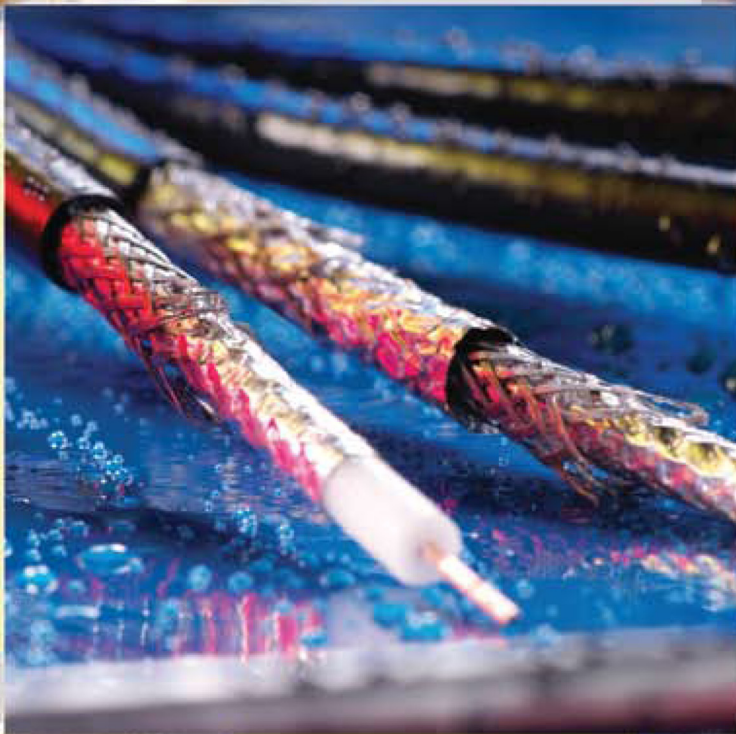
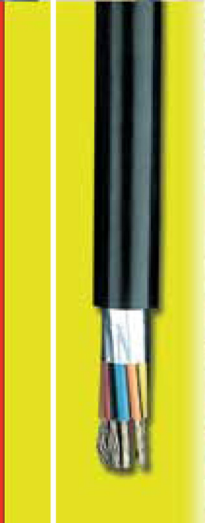

ELECTRONIC WIRE AND CABLE FOR
SIGNAL TRANSMISSION AND SOUND/SECURITY
APRIL 2010

Join the Wire Wizard for a quick, informative tour showing the interactive features of our catalogs

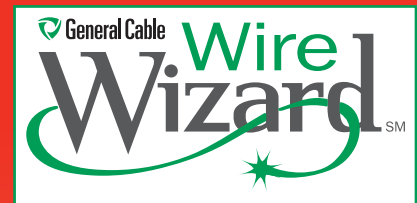

WELCOME

On-Line Catalog Features

- View the catalog in full screen mode by using the far left expansion logo on the menu bar. (Keyboard input may not work in full screen mode, which means you must leave the full screen mode in order to utilize the email function.)
- Click the “General Cable” logo on the left side of the menu bar to go to General Cable’s Web site.
- The Table of Contents button in the center of the menu bar takes you to a fully interactive page(s). Click on any product category or listing to take you to the appropriate page. (All other page references throughout the catalog are also fully interactive.)
- The entire catalog’s contents can be searched using the Search button located in the upper right of the menu bar.
- Turn catalog pages by clicking your mouse on the top or bottom corner of the page or by using the forward or back arrows on the side of the page or on the bottom bar.
- Zoom to details on each page by clicking when the magnifying glass pointer is active. Click again to return to full view.
- Share the complete interactive catalog by selecting the “Share this Publication” icon located in the lower right on the bottom bar.
- Print all or selected pages using the Print icon located in the lower right on the bottom bar.
- The entire interactive catalog or individual pages can be downloaded as a PDF using the PDF icon located in the lower right on the bottom bar.
- Use “Crop part of page” icon located in the lower right on the bottom bar to take a snapshot of any part of a page and save as a jpg.



[General Cable Website](#)



[Contact Us](#)

Electronics

This catalog contains in-depth information on the most comprehensive line of copper Electronics products available today for data transmission, sound, security/fire alarm, professional audio and video broadcast.

In a rapidly changing industry with ever-growing demands, General Cable continues to stay ahead of the curve with engineered products that guarantee future performance. Choose from the best cable in its class—Carol® Brand.

Our products are readily available for immediate shipment through our network of authorized stocking distributors and distribution centers.



All information in this catalog is presented solely as a guide to product selection and is believed to be reliable. All printing errors are subject to correction in subsequent releases of this catalog. Although General Cable has taken precautions to ensure the accuracy of the product specifications at the time of publication, the specifications of all products contained herein are subject to change without notice.

GENERAL CABLE, CAROL BRAND, CAROLPRENE, COMMAND SERIES, DEMAND BETTER...EXPECT MORE, FLEXFOIL, HELIX/HI-TEMP, LO-CAP, MOISTURE GUARD, ONE COMPANY CONNECTING THE WORLD, PULL-PAC, SMARTWRAP, SPOOL-PAC, SUPERFLEX, WIRE WIZARD and logos are trademarks of General Cable Technologies Corporation.

©2010. General Cable Technologies Corporation. Highland Heights, KY 41076
All rights reserved. Printed in USA.

Demand Better... Expect More™

FROM CAROL® BRAND

QUALITY

General Cable is committed to meeting customer requirements through continuous quality improvements. As a significant part of our commitment to quality, General Cable's manufacturing facilities are certified to the ISO 9001:2000 quality standard. We strive to provide value optimization through innovation and quality solutions.

- Our in-house testing capabilities are extensive, with strict adherence to our product specifications as well as industry standards.
- Cables are safety listed and verified.
- Third-party testing labs like UL and ETL are utilized to quantify and confirm our quality and provide final qualification data that sets the foundation for our extended product warranty.
- General Cable products have stood the test of time with proven reliability and performance.

INTERNATIONAL
ISO 9001:2000
CERTIFICATION

CUSTOMER SERVICE



General Cable is dedicated to customer service and satisfaction. Call our team of professionally trained sales associates at

888-295-5896

with any questions to meet your application needs.

GENERALCABLE.COM

What's New?

EXPANDED COMPETITIVE OFFERINGS



Cross-Reference & Online Spec Sheets

We have expanded our Carol® Brand Electronics offering and now have more competitive crosses than anyone. Many of these cables are in stock and ready for immediate shipment from one of our stocking distributors. For questions on any of the Carol Electronics cables, detailed spec sheets are now available online at www.generalcable.com/Products/Electronics/Product Specification Sheets.

LOOKING FOR PLENUM CABLES?



The Carol® Electronics Catalog has been revamped, with Plenum Cables now being featured in the Communications & Control Multi-Conductor and Multi-Paired sections. If you're still not sure what you're looking for, please contact our Customer Service associates at 866.295.5896 today!

ALARM & SECURITY SOLUTIONS



General Cable has increased the information in its Alarm & Security Solutions Guide, with the addition of Sheer Wire™ Cables for Lighting Control & Touch Panel Systems, Bundled Composite Access Control Cables, Command® Series Home Entertainment Cables and our line of Carol® Brand Helix/Hi-Temp® Data Communications Cables. To view the updated guide, see pages 114-116 in the catalog.

SHEER WIRE™ PRODUCTS

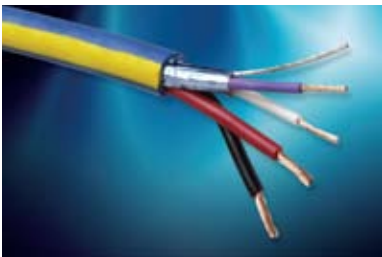

Carol® Brand has added the Sheer Wire™ line of cable for Lighting Control & Touch Panel Systems to its already expansive electronics offering. For more information, see page A2 or call 866-295-5896 today for your FREE Sheer Wire catalog.

ARMORED ELECTRONICS PRODUCTS



Carol® Brand Electronics products are now offered with an interlock armored option, which provides outstanding mechanical protection and is flexible for easy installation, potentially saving time and money. For complete product information, go to pages 179-180.

Carol® Brand Alarm & Security Solutions

SHEER WIRE™

Sheer Wire™ Lighting Control and Touch Panel Systems

Call today for your
**FREE COMPLETE
SHEER WIRE™
CATALOG**
1.866.295.5896

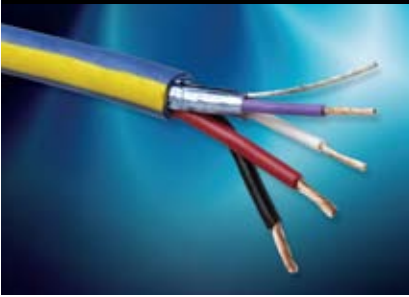

Cable Solution	Description
1618SVA1	18/4 16/30 BC 20 AWG 10/30 + 16/1 PR 26/30 BC (UL) CL3R
1822AXL0	22/1PR 7/30 + 18/2 7/26 (UL) CL3R FT-4
1822CCD8	Touch Panel Composite: 1 Control Element + 2 5e Elements
1822CCT8	Touch Panel Composite: 1 Control Element + 2 5e Elements + 2 RG 6
1822CDC8	22C 5E: (1)18/22CRT-89/04, (1)181VQ6-09, 181VQ6-00, (2) Cat 5e
1822CRT8	Comp 4C 2E: 22/1PR 7/30 BC 24 AWG 7/32 TC Drain + 1/2C 7/26 BC (UL) CL3R
1822KYP1	Comp 4C 2E: 18/2C 16/30 BC + 22/1PR 7/30 BC Shielded
182LUTDS	18/2 7/26 BC PVC NYLON (UL) TC for Lutron Dimmer & Switch
184LUTDS	18/4 7/26 BC PVC Nylon O/A AM SHLD 20 AWG 7/36 TC Drain PVC
222LUTDS	22/2 7/30 BC PVC O/A AM SHLD 24 AWG 7/32 TC Drain PVC
164LTCH0	16/4 65/34 BC .012" PVC Lite Touch
224SLTCH	22/4 7/30 BC .015 PVC, O/A AM SHLD, 24 7/32 TC Drain/A 0.35 PVC Lite Touch
EF24C0021000	24/2 Conductor Shielded Low Cap Type CMP

Applications:

- Lighting Controls
- Window Controls
- Audio Level Controls
- Video Controls
- Computer/Internet Controls

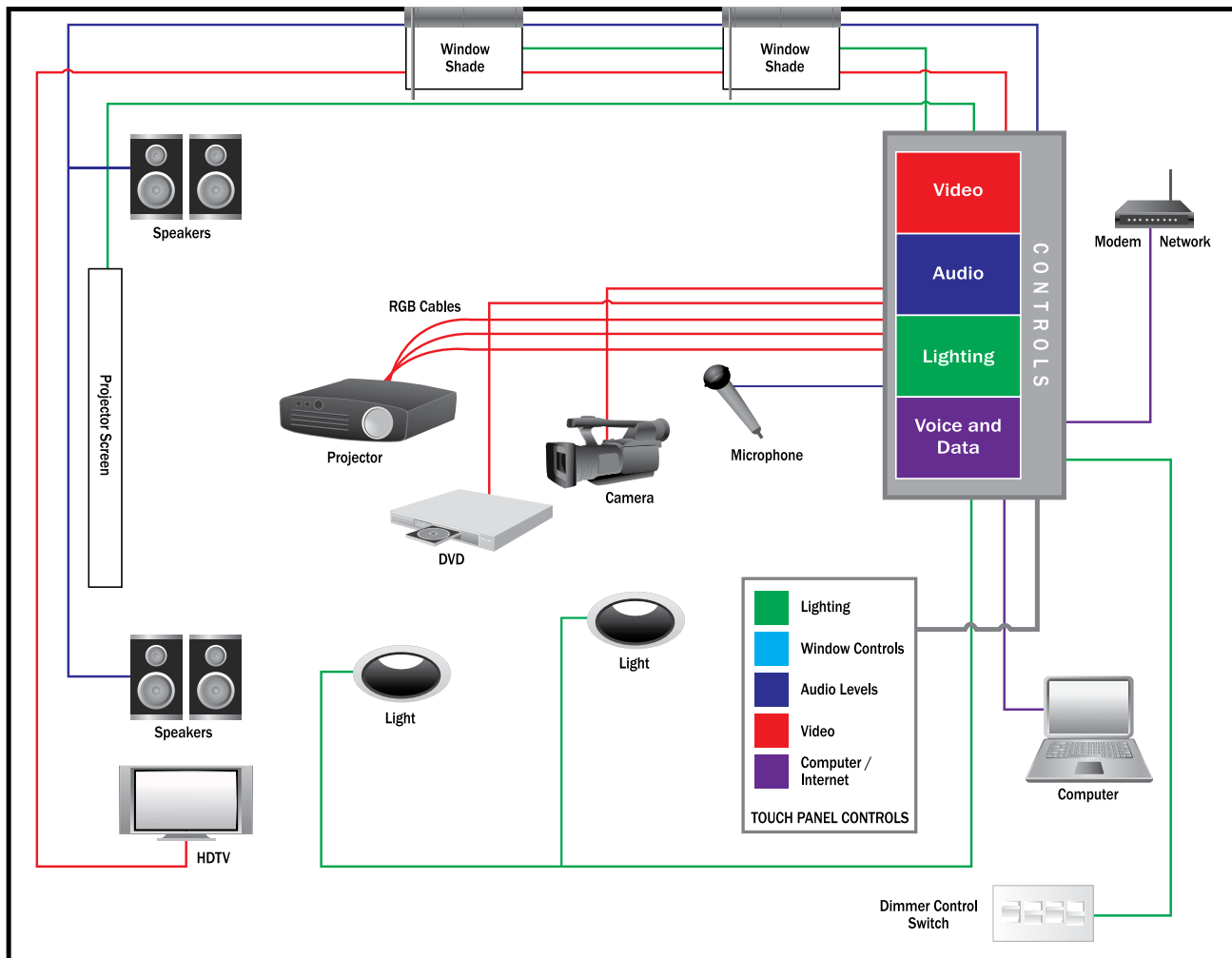

PRODUCT SECTION LOCATOR

SECTION

PAGES

1 Hook-Up Wire

1-7

2 Communication & Control Cable, Multi-Conductor

8-41

3 Communication & Control Cable, Multi-Paired

42-66

4 Computer Cable

67-84

5 Coaxial Cable

85-112

6 Fire Alarm/Life Safety Cable

113-129

7 Sound, Alarm & Security Cable

130-145

8 Audio/Video & Home Entertainment Cable

146-177

9 Specialty Cable

178-185

10 Technical Information

186-247

Table of Contents

SECTION	PAGES
1 Hook-Up Wire	1-7
UL 1007, UL 1569, CSA TR-64	2
UL 1015, CSA TEW	3
MIL-W-76B	4
UL Types MTW, TFF, AWM & CSA TEW	5
Heavy Wall UL Types MTW, AWM & NEC Type THW	6
Rubber/PVC/Polyethylene	7
2 Communication & Control Cable, Multi-Conductor	8-41
Multi-Conductor, Unshielded	9-17
Multi-Conductor, Unshielded (CSA)	18-20
Multi-Conductor, Rubber, Unshielded	21
Power-Limited Tray Cable, Unshielded	22
Multi-Conductor, Foil Shield	23-28
Multi-Conductor, Foil Shield (CSA)	29-31
Power-Limited Tray Cable, Foil Shield	32
Multi-Conductor, Spiral Shield	33
Multi-Conductor, Braid Shield	34-37
Multi-Conductor, Foil/Braid Shield	38
Multi-Conductor, Foil & TC Braid Shield	39
Multi-Conductor, Rubber, Braid Shield	40
Multi-Conductor, Carolprene®, Braid Shield	41
3 Communication & Control Cable, Multi-Paired	42-66
Multi-Paired, Unshielded	43-45
Multi-Paired, Foil Shield	46-52
Multi-Paired, Foil Shield (CSA)	53-54
Multi-Paired, Foil Shield, Mid-Cap	55
Multi-Paired, Foil Shield, Lo-Cap®	56
Multi-Paired, Overall Foil & TC Braid Shield, Lo-Cap®	57
Multi-Paired, Individually Shielded	58
Multi-Paired, Individually Shielded (CSA)	59
Multi-Paired, Individually Shielded, Overall Shield	60
Multi-Paired, Individually Foil Shielded	61-64
Power-Limited Tray Cable, Individually Shielded	65
Power-Limited Tray Cable, Foil Shield or Foil/Braid Shield	66

Table of Contents

SECTION **PAGES**

4 Computer Cable **67-84**

Multi-Conductor, Foil Shield.....	68-69
Multi-Conductor, Foil/Braid Shield	70-71
Multi-Conductor, Foil/Braid Shield, Lo-Cap®	72
Multi-Paired, Foil Shield	73
Multi-Paired, Foil Shield, Lo-Cap®	74
Multi-Paired, Foil/Braid Shield.....	75
Multi-Paired, Foil/Braid Shield, Lo-Cap®.....	76-79
Multi-Paired, Individually Foil Shielded	80-82
Multi-Paired, Individually Foil Shielded, Lo-Cap®	83
Multi-Paired, Individually Foil/Braid Shielded, Lo-Cap®.....	84

5 Coaxial Cable **85-112**

Coaxial Solutions Guide..... 86-87

RG 6/U Type	88-93
RG 8/U Type	94-95
RG 11/U Type.....	96-99
RG 58/U Type	100
RG 59/U Type.....	101-108
RG 62/U Type	109
RG 174/U Type	110
RG 213/U Type	111
Twinaxial Cables.....	112

6 Fire Alarm/Life Safety Cable **113-129**

Alarm & Security Solutions Guide..... 114-116

Multi-Conductor, Unshielded, Non-Plenum	117
Multi-Conductor, Unshielded, Non-Plenum (CSA).....	118
Multi-Conductor, Shielded, Non-Plenum	119
Multi-Conductor, Shielded, Non-Plenum (CSA)	120
Multi-Conductor, Unshielded, Plenum	121-122
Multi-Conductor, Shielded, Plenum	123-124
Mid-Capacitance, Unshielded, Non-Plenum	125
Mid-Capacitance, Shielded, Non-Plenum.....	126
Mid-Capacitance, Unshielded, Plenum.....	127
Mid-Capacitance, Shielded, Plenum.....	128
Multi-Paired, Unshielded, Non-Plenum (CSA)	129

Table of Contents

SECTION	PAGES
7 Sound, Alarm & Security Cable	130-145
Composite Access Control Cable.....	131
Composite Access Control Cable, Plenum.....	132
Composite Access Control Cable, Riser.....	133
Multi-Conductor, Unshielded, Riser	134
Multi-Conductor, Shielded, Riser	135
Multi-Conductor, Unshielded, Plenum	136
Multi-Conductor, Shielded, Plenum	137
Telephone Station/Intercom & Speaker/Burglar Alarm	138
Antenna Rotor	139
Low-Voltage Sprinkler Wire	140
Thermostat Wire Type LVT	141
Thermostat Wire Type CL2.....	142
Thermostat Wire, Unjacketed.....	143
Carol® Helix/Hi-Temp® Category 6 Cable	144
Carol® Helix/Hi-Temp® Category 5e Cable.....	145
8 Audio/Video & Home Entertainment Cable	146-177
Command® Series Home Entertainment Cables Guide.....	147-148
Command® Series Cruise Ship Cables Guide	149-150
Command® Series Speaker Cable	151-155
Speaker Wire	156
Superflex® Speaker Wire	157
Pro Audio Speaker Wire	158
Special Audio, Communication & Instrumentation	159-161
Low Skew 4-Pair UTP	162
SmartWrap™ Bundled Cable.....	163
Direct Burial, Audio & Communication.....	164-165
Digital Audio Snake Cable.....	166
Analog Audio Snake Cable	167-168
Guitar/Instrument Cable	169
Ultra Flexible, Low Impedance 2-Conductor Microphone Cable	170
Multi-Conductor, Flexfoil® Shield	171
Multi-Conductor, Rubber, Braid Shield Microphone Cable.....	172
Multi-Conductor, Spiral Shield	173
Multi-Conductor, Braid Shield.....	174
Microphone Cable, Multi-Conductor, Carolprene®, Braid Shield.....	175
SMPTE-311 Hybrid Fiber Optic/Copper Camera Cable.....	176
Electronic News Gathering/Field Production Camera Cable.....	177

Table of Contents

SECTION

PAGES

9 Specialty Cable 178-185

Armored Electronics Products Guide..... 179-180

Wind Energy..... 181

Fluorobus Cable 182

Fire Wire 183

Computer Cable 184

Composite Data and Control Cable 185

10 Technical Information 186-247

Insulation & Jacket Properties..... 187

Decimal Conversion Factors 188

Unit Conversion Factors..... 189

Temperature Conversion Chart 190

Conduit Capacity Chart..... 191

Coax Connector Cross Reference 192-199

AWG Conductor Chart 200

Cable Design Equations—Braid Shield..... 201

Cable Design Equations—Coaxial Cable..... 202

Cable Design Equations—Balanced Pair..... 203

Engineering Prefixes..... 204

Glossary..... 205-215

Abbreviations & Acronyms 216-218

Product Finder—Hook-Up Wire 219

Product Finder—Multi-Conductor Cable 220-222

Product Finder—Multi-Paired Cable 223-225

NEC/CEC Substitution Chart 226-227

Agency Symbols..... 228

Agency Approval Index 229

Put-Ups and Color Codes..... 230

Applications Index..... 231-233

Belden-to-General Cable Carol® Brand Cross Reference Index 234-239

Part Number Index 240-246

Notes 247



There is a reason
we call him -

Wire Wizard.SM

Alben Roland –Wire Wizard.SM When it comes to solving your problems, he makes magic happen.

Alben's highest and most challenging form of wire wizardry is new product development, followed closely by solving tough, often one-of-a-kind technical problems. His powers are also evident in quality control and in laboratory testing. We call on Alben to perform his wizardry all the time. And so do our customers. Alben, Manager, Product Engineering, Carol[®] Brand Electronic Products, and the entire team of General Cable Wire Wizards are ready to perform magic. "Whether it's providing a prototype, solving an applications problem, or answering a technical question, we try to make magic happen," explains Alben. Magic or not, our Wizards always seem to find the answer and serve the customer. And there's no smoke or mirrors about that.

**CAROL[®]
BRAND**

If you'd like to put the powers of Alben and General Cable Carol Brand products to work for you, talk to a General Cable rep today. To connect, just call 1.888.295.5896 or e-mail us at info@generalcable.com.

REEL People ... Adding REAL Value

 **General Cable**
www.generalcable.com



Building Bridges in the Sky

Making Contact with the World

Directing Traffic without Gridlock

General Cable is a leader in the development, design, manufacture, marketing and distribution of copper, aluminum and fiber optic wire and cable for the energy, industrial, specialty and communications markets.

Our products inspire progress worldwide ... customers use our value-added products to create global infrastructure that improves the standard of living for people everywhere.

Each day we're building business momentum — developing ideas into innovative solutions and industry-leading products, expanding geographic access and furthering our investment in highly capable associates, Lean Manufacturing, material science and technology resources.

General Cable is influencing the world ... with more than two-thirds of our sales generated outside North America and more than 11,000 associates in 45 manufacturing facilities throughout 22 countries. As one of the largest wire and cable manufacturers, we are the *One Company Connecting the World*.

Energy Cables

Our cables carry energy across the world — through the air, underground and under the sea. Increasing demand for energy is accelerating investment in exploration, extraction, power generation, transmission and distribution — whether based on coal, natural gas, oil, nuclear, wind, solar or water.

Industrial & Specialty Cables

Our cables channel the power and signals that make equipment hum and engines run. From oil rigs and broadcast studios to cars and trains, and in commercial buildings, public venues, factory floors and special applications such as military, nuclear, marine and mining — we serve an extensive range of markets.

Communications Cables

Our cables keep information flowing — facilitating a non-stop stream of words and images around the world. We meet the high-speed bandwidth needs of global communications networks, from fiber optic submarine communications cables, copper and fiber aerial and underground cables, to copper and fiber optic enterprise cables and system solutions.

World Headquarters - General Cable

4 Tesseneer Drive • Highland Heights, KY • 41076-9753 U.S.A.



Our Green Initiative symbol recognizes our role and responsibility in promoting sustainability. The symbol also reflects our commitment to achieving industry-leading standards and responding proactively to environmental global issues.

Look for our products with the RoHS symbol for your green building initiatives.



Visit www.generalcable.com
Select "company", then select "environmental"



Hook-Up Wire

1

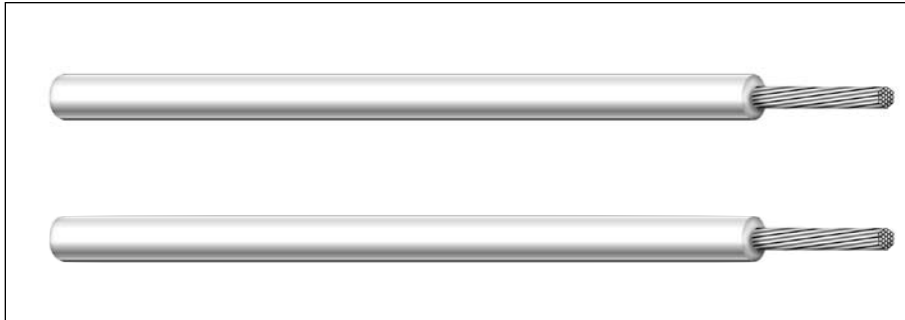

Most applications of hook-up and lead wire for board-to-board or point-to-point wiring rely on PVC-insulated designs.

General Cable's Carol® Brand products offer both electrical and electronic designers a vast array of quality PVC hook-up wire to meet the specific technical demands of today, with "off-the-shelf" distributor inventoried products.

Hook-up wire is also available in special colors and/or stripe combinations with a minimum of lead time. In addition, General Cable offers a variety of put-ups to meet individual customer requirements.

Index	Page
UL 1007, UL 1569, CSA TR-64	2
UL 1015, CSA TEW	3
MIL-W-76B	4
UL Types MTW, TFF, AWM & CSA TEW	5
Heavy Wall UL Types MTW, AWM & NEC Type THW	6
Rubber/PVC/Polyethylene	7

UL 1007, UL 1569, CSA TR-64

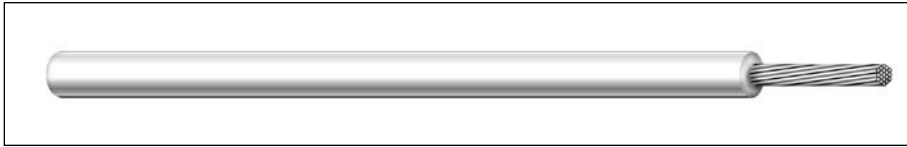

Product Construction:

Conductor:

- 24 thru 16 AWG
- Fully annealed tinned copper per ASTM B-33
- Solid or stranded

Insulation:

- Premium-grade, color-coded PVC
- Temperature range: -20°C to +105°C
- Color code: See chart below

Applications:

- Internal wiring of electrical and electronic equipment
- Internal wiring of panels and meters
- Point-to-point wiring
- Suggested voltage rating: 300 volts

Compliances:

- UL Style 1007 – 80°C, 300V
- UL Style 1569 – 105°C, 300V
- CSA TR-64 – 90°C, 300V
- RoHS Compliant Directive 2002/95/EC
- Designed to meet UL VW-1 Vertical Wire Flame Test

Packaging:

- Please contact Customer Service for packaging and color options

CATALOG NUMBER	AWG SIZE	COND. STRAND	NOM. INSULATION THICKNESS		NOMINAL O.D.	
			INCHES	mm	INCHES	mm

SOLID CONDUCTORS

C2003A	24	Solid	0.016	0.41	0.052	1.32
C2004A	22	Solid	0.016	0.41	0.057	1.45
C2028A	20	Solid	0.016	0.41	0.064	1.63
C2052A	18	Solid	0.016	0.41	0.072	1.83
C2053A	16	Solid	0.016	0.41	0.083	2.11

STRANDED CONDUCTORS

C2015A	24	7/32	0.016	0.41	0.056	1.42
C2016A	22	7/30	0.016	0.41	0.062	1.57
C2040A	20	10/30	0.016	0.41	0.070	1.78
C2064A	18	16/30	0.016	0.41	0.080	2.03
C2065A	16	26/30	0.016	0.41	0.092	2.34

Color Code Chart

ORDERING SUFFIX	COLORS	ORDERING SUFFIX	COLORS
01	Black	06	Green
02	White	07	Blue
03	Red	08	Brown
04	Orange	10	Gray
05	Yellow	19	Violet

Striped combinations available upon request; consult Customer Service.



Designed to Meet
UL VW-1 Vertical
Wire Flame Test

Underwriters Laboratories Inc.



UL 1015, CSA TEW

Product Construction:

Conductor:

- 24 thru 10 AWG
- Fully annealed tinned copper per ASTM B-33
- Solid or stranded

Insulation:

- Premium-grade, color-coded PVC
- Temperature range: -20°C to +105°C
- Color code: See chart below

Applications:

- Internal wiring of electrical and electronic equipment
- Internal wiring of panels and meters
- Point-to-point wiring
- Suggested voltage rating: 600 volts

Compliances:

- UL Style 1015 – 105°C, 600V
- CSA Type TEW
- RoHS Compliant Directive 2002/95/EC
- Designed to meet UL VW-1 Vertical Wire Flame Test

Packaging:

- Please contact Customer Service for packaging and color options

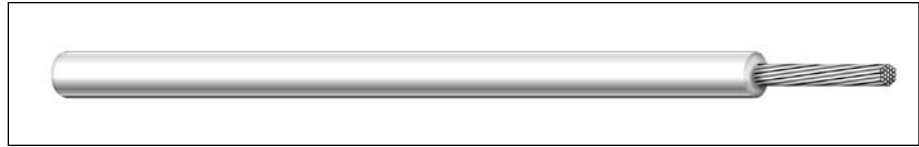

CATALOG NUMBER	AWG SIZE	COND. STRAND	NOM. INSULATION THICKNESS		NOMINAL O.D.	
			INCHES	mm	INCHES	mm

SOLID CONDUCTORS

C2117A	22	Solid	0.032	0.81	0.089	2.26
C2118A	20	Solid	0.032	0.81	0.096	2.44
C2119A	18	Solid	0.032	0.81	0.104	2.64

STRANDED CONDUCTORS

C2100A	24	7/32	0.032	0.81	0.088	2.24
C2101A	22	7/30	0.032	0.81	0.094	2.39
C2102A	20	10/30	0.032	0.81	0.102	2.59
C2103A	18	16/30	0.032	0.81	0.112	2.84
C2104A	16	26/30	0.032	0.81	0.124	3.15
C2105A	14	41/30	0.032	0.81	0.141	3.58
C2106A	12	65/30	0.032	0.81	0.160	4.06
C2107A	10	105/30	0.033	0.84	0.184	4.67

Color Code Chart

ORDERING SUFFIX	COLORS	ORDERING SUFFIX	COLORS
01	Black	06	Green
02	White	07	Blue
03	Red	08	Brown
04	Orange	10	Gray
05	Yellow	19	Violet

Striped combinations available upon request; consult Customer Service.

MIL-W-76B

Type MW

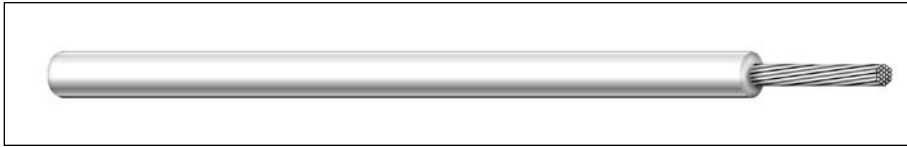

Product Construction:

Conductor:

- 24 thru 12 AWG
- Fully annealed stranded tinned copper per ASTM B-33

Insulation:

- Premium-grade, color-coded PVC
- Type MW: Medium wall
- Temperature range: -12°C to +90°C
- Color code: See chart below

Applications:

- Internal wiring of electrical and electronic equipment
- Internal wiring of panels and meters
- Point-to-point wiring
- Suggested voltage rating: 1000 volts (MIL-W-76B)
- Non QPL

Compliances:

- RoHS Compliant Directive 2002/95/EC

Packaging:

- Please contact Customer Service for packaging and color options

CATALOG NUMBER	TYPE DESIGNATION	AWG SIZE	COND. STRAND	NOM. INSULATION THICKNESS		NOMINAL O.D.	
				INCHES	mm	INCHES	mm
MIL-W-76B TYPE MW (MEDIUM WALL)							
C7600A	MW-C24(7)U	24	7/32	0.016	0.41	0.056	1.42
C7602A	MW-C22(7)U	22	7/30	0.016	0.41	0.062	1.57
C7604A	MW-C20(10)U	20	10/30	0.016	0.41	0.070	1.78
C7606A	MW-C18(16)U	18	16/30	0.016	0.41	0.080	2.03
C7608A*	MW-C16(26)U	16	26/30	0.016	0.41	0.092	2.34
C7610A*	MW-C14(41)U	14	41/30	0.016	0.41	0.109	2.77
C7611A*	MW-C12(65)U	12	65/30	0.016	0.41	0.128	3.25

*-25°C to +105°C

Color Code Chart

ORDERING SUFFIX	COLORS	ORDERING SUFFIX	COLORS
01	Black	06	Green
02	White	07	Blue
03	Red	08	Brown
04	Orange	10	Gray
05	Yellow	19	Violet

Striped combinations available upon request; consult Customer Service.

UL Types MTW, TFF, AWM & CSA TEW

90°C 600 Volt MTW, TFF 105°C 600 Volt AWM/TEW

Product Construction:

Conductor:

- 18 through 8 AWG fully annealed stranded bare copper per ASTM B-8

Insulation:

- Premium-grade, color-coded PVC
- Temperature range:
MTW: -40°C to +90°C
TEW/AWM: -20°C to +105°C
- Color code: See chart below

Jacket Marking:

- 18 and 16 AWG:
CAROL (SIZE) 600V E# MTW (UL) OR TFF OR AWM VW-1 --- CSA TEW 105°C FT-1
- 14 through 8 AWG:
CAROL (SIZE) 600V E# MTW (UL) OR AWM VW-1 --- CSA TEW 105°C FT-1

Applications:

- Motor and transformer lead
- External wiring of machinery
- Internal wiring of electrical and electronic equipment
- Internal wiring of panels and meters
- Point-to-point wiring

Features:

- Outstanding oil, flame and moisture resistance
- Extra flexible

Compliances:

- UL and NMTBA Type MTW/AWM
- CSA TEW
- RoHS Compliant Directive 2002/95/EC
- Passes VW-1 Vertical Flame Test
- AWM Style 1015 – 18-8 AWG
- AWM Style 1335 – 18-10 AWG
- AWM Style 1336 – 8 AWG

Packaging:

- Please contact Customer Service for packaging and color options

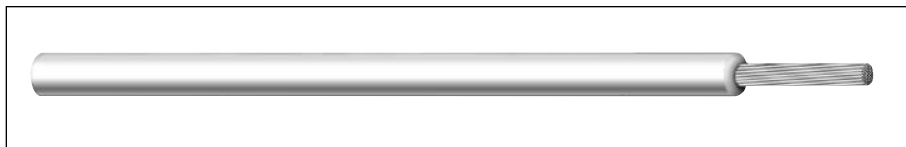

CATALOG NUMBER	AWG SIZE	COND. STRAND	NOM. INSULATION THICKNESS		NOMINAL O.D.		STOCK COLORS	APPROX. NET WEIGHT LBS/M ^(S)
			INCHES	mm	INCHES	mm		
UL TYPE MTW, AWM, TFF, CSA TYPE TEW-600 VOLT								
76502	18	16/30	0.032	0.81	0.110	2.79	1-12	10
76512	16	26/30	0.032	0.81	0.123	3.12	1-12	14
76812	14	19/.0159	0.032	0.81	0.136	3.40	1-12	20
76822	12	19/.0185	0.032	0.81	0.155	3.91	1-7	28
76832	10	19/.0234	0.032	0.81	0.179	4.55	1-5	42
76843	8	19/.0295	0.047	1.19	0.242	6.15	1-5	72

^(S)Actual shipping weight may vary.

Color Code Chart

ORDERING SUFFIX	COLORS	ORDERING SUFFIX	COLORS
01	Black	04	Orange
02	White	08	Brown
03	Red	19	Purple
07	Blue	10	Gray
06	Green	13	Pink

Heavy Wall UL Types MTW, AWM & NEC Type THW

90°C 600 Volts

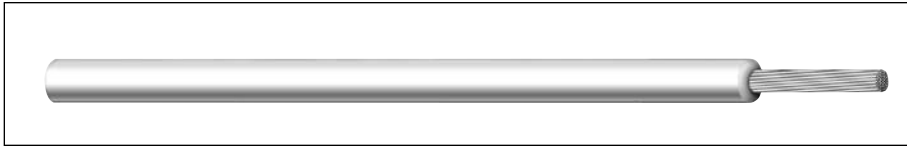

CATALOG NUMBER	AWG SIZE	COND. STRAND	NOM. INSULATION THICKNESS		NOMINAL O.D.		APPROX. NET WEIGHT LBS/m ^(S)
			INCHES	mm	INCHES	mm	
AWM, MTW, THW – 600 VOLT – UL							
76954	6	19/.0372	0.064	1.63	0.315	8.00	110
76994	4	19/.0469	0.065	1.65	0.365	9.27	150

^(S)Actual shipping weight may vary.

Product Construction:

Conductor:

- 6 and 4 AWG fully annealed stranded bare copper per ASTM B-8

Insulation:

- Premium-grade, color-coded PVC, black
- Temperature range: -40°C to +90°C

Jacket Marking:

- CAROL 6 AWG 600V E# MTW OR THW (UL) OR AWM

Applications:

- Motor and transformer lead
- External wiring of machinery

Features:

- Outstanding oil, flame and moisture resistance
- Extra flexible

Compliances:

- UL Type AWM
- UL and NMTBA Type MTW
- NEC Type THW
- RoHS Compliant Directive 2002/95/EC
- Passes UL VW-1 Vertical Flame Test

Packaging:

- Please contact Customer Service for packaging and color options



Designed to Meet
UL VW-1 Vertical
Wire Flame Test

Underwriters Laboratories Inc.



Rubber/PVC/Polyethylene

Product Construction:

Conductor:

- 20, 18 and 14 AWG
- Fully annealed stranded tinned copper per ASTM B-33

Insulation:

- Premium-grade, color-coded rubber, PVC or polyethylene
- Temperature range:
 - 20°C to +60°C rubber
 - 25°C to +60°C PVC
 - 20°C to +80°C polyethylene
- Color code: See chart below

Applications:

- Test equipment
- Oscillators

Compliances:

- RoHS Compliant Directive 2002/95/EC

Packaging:

- Please contact Customer Service for packaging and color options

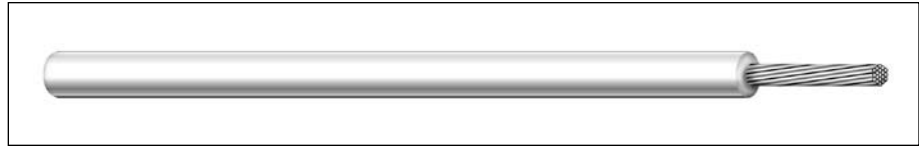

CATALOG NUMBER	NO. OF COND.	AWG SIZE	COND. STRAND	NOM. INSULATION THICKNESS		BREAKDOWN VOLTAGE (AC, rms)	WORKING VOLTAGE*	NOMINAL O.D.	
				INCHES	mm			INCHES	mm

RUBBER TEST LEAD

C1326	1	20	41/36	0.040	1.02	6,000V	1,500V	0.125	3.18
C1319	1	20	41/36	0.047	1.19	12,000V	3,000V	0.140	3.56
C1321	1	18	65/36	0.045	1.14	20,000V	5,000V	0.145	3.68
C1318	1	18	65/36	0.088	2.24	29,000V	10,000V	0.230	5.84

PVC TEST LEAD

C1320A	1	18	65/36	0.047	1.19	20,000V	5,000V	0.140	3.56
---------------	---	----	-------	-------	------	---------	--------	-------	------

POLYETHYLENE TEST LEAD

C7108A	1	14	105/34	0.032	0.81	4,000V	600V	0.140	3.56
---------------	---	----	--------	-------	------	--------	------	-------	------

*For intermittent duty only.

Color Code Chart

ORDERING SUFFIX	COLORS
01	Black
03	Red
06	Green

Communication & Control Cable, Multi-Conductor

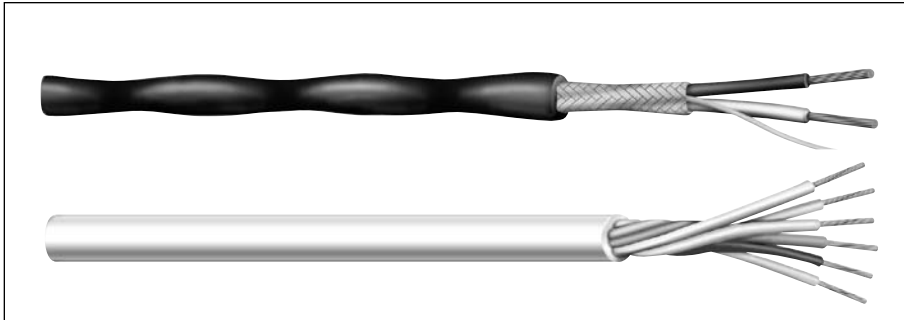

The multi-conductor array of communication and control cable facilitates cable pull-ins and single-site installations.

This cable is typically used for industrial equipment control, electric valve actuation and remote signaling, as well as communications and broadcast applications. These designs are available in a wide variety of insulation and jacketing materials, as well as shield designs to alleviate unwanted circuit noise.

General Cable's Carol® Brand products are manufactured to meet the latest UL, CSA and NEC requirements and approvals.

A Design To Meet Every Application

PVC/PVC designs employ polyvinyl chloride insulations and jackets capable of meeting everyday, general purpose applications.

PE or PP/PVC designs employ high quality polyethylene or polypropylene insulations to assure faithful reproduction of transmitted signals across interconnection circuits.

Foamed PP/PVC designs use high speed, foamed polypropylene insulations for long-distance critical circuits, which would not perform if higher loss insulations were employed.

FEP/FEP designs employ fluoropolymer 200°C-rated materials. They are recommended for use in applications where high temperature, plenum rating, electrical and mechanical safety and chemical resistance are essential.

Rubber/Rubber is typically employed in installations characterized as severely hostile environments, where these designs provide unsurpassed service life.

Rubber/Carolprene® offers the ultimate performance for applications that demand the greatest protection from the environment, including physical abuse. The specially formulated Carolprene® jacket has been proven time and again to withstand all types of abuse, both mechanical and chemical.

Index	Page
Multi-Conductor, Unshielded	9-17
Multi-Conductor, Unshielded (CSA)	18-20
Multi-Conductor, Rubber, Unshielded	21
Power-Limited Tray Cable, Unshielded	22
Multi-Conductor, Foil Shield	23-28
Multi-Conductor, Foil Shield (CSA)	29-31
Power-Limited Tray Cable, Foil Shield	32
Multi-Conductor, Spiral Shield	33
Multi-Conductor, Braid Shield	34-37
Multi-Conductor, Foil/Braid Shield	38
Multi-Conductor, Foil & TC Braid Shield	39
Multi-Conductor, Rubber, Braid Shield	40
Multi-Conductor, Carolprene®, Braid Shield	41

Multi-Conductor, Unshielded

UL 2464, NEC Type CM (UL) c(UL), CSA CMG

Product Construction:

Conductor:

- Fully annealed tinned copper per ASTM B-33 (C4008A, C4311A)
- Fully annealed solid bare copper per ASTM B-3 (C2754A)

Insulation:

- Premium-grade, color-coded S-R PVC per UL 1061

Jacket:

- PVC, gray
- Temperature range: -20°C to +80°C

Applications:

- Public address systems
- Intercoms
- Remote control circuits
- Suggested voltage rating: 300 volts

Compliances:

- NEC Article 800 Type CM (UL: 75°C)
- UL Style 2464 (UL: 80°C, 300V)
- CSA CMG (CSA: 60°C)
- RoHS Compliant Directive 2002/95/EC
- Designed to meet UL 70,000 BTU Vertical Tray Flame Test
- Passes CSA CMG Flame Test

Packaging:

- Please contact Customer Service for packaging and color options

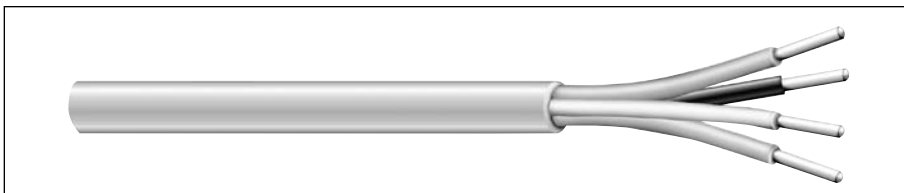

CATALOG NUMBER	NO. OF COND.	AWG SIZE	COND. STRAND	NOM. INSULATION THICKNESS		NOM. JACKET THICKNESS		NOMINAL O.D.		COLOR CODE	NOM. C-C CAP.* pF/ft
				INCHES	mm	INCHES	mm	INCHES	mm		
C4008A	2	22	Solid	0.010	0.25	0.032	0.81	0.156	3.94	Black/Red	24.5
C4311A	2	20	Solid	0.010	0.25	0.032	0.81	0.166	4.22	Black/Red	28.0
C2754A	2	19	Solid	0.010	0.25	0.032	0.81	0.176	4.47	Brown/Tan	29.5

*Capacitance between conductors

Multi-Conductor, Unshielded

UL 2464, NEC Type CM (UL) c(UL), CSA CMG

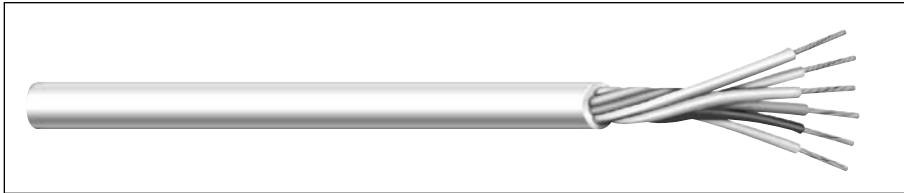

Product Construction:

Conductor:

- 22 thru 18 fully annealed stranded tinned copper per ASTM B-33

Insulation:

- Premium-grade, color-coded PVC (18 AWG), S-R PVC (22 AWG)
- Color code: See chart below

Jacket:

- PVC, gray
- Temperature range: -20°C to +80°C

Applications:

- TV antenna rotor control
- Satellite actuator control
- Public address systems
- Suggested voltage rating: 300 volts

Features:

- Tinned copper conductors provide excellent corrosion resistance
- Assists with soldering applications

Compliances:

- NEC Article 800 Type CM (UL: 75°C)
- UL Style 2464 (UL: 80°C, 300V)
- CSA CMG (CSA: 60°C)
- RoHS Compliant Directive 2002/95/EC
- Designed to meet UL 70,000 BTU Vertical Tray Flame Test
- Passes CSA CMG Flame Test

Packaging:

- Please contact Customer Service for packaging and color options

CATALOG NUMBER	NO. OF COND.	AWG SIZE	COND. STRAND	NOM. INSULATION THICKNESS		NOM. JACKET THICKNESS		NOMINAL O.D.		NOM. C-C CAP* pF/ft
				INCHES	mm	INCHES	mm	INCHES	mm	
C4081A	6	4-22 2-18	7/30 16/30	0.010 0.016	0.25 0.41	0.032	0.81	0.244	6.20	24.5 31.0
C4082A	7	5-22 2-18	7/30 16/30	0.010 0.016	0.25 0.41	0.032	0.81	0.253	6.43	24.5 31.0
C4083A	8	6-22 2-18	7/30 16/30	0.010 0.016	0.25 0.41	0.032	0.81	0.263	6.69	24.5 31.0
C4084A	9	7-22 2-18	7/30 16/30	0.010 0.016	0.25 0.41	0.032	0.81	0.273	6.94	24.5 31.0

*Capacitance between conductors

Color Code Chart

NO. OF COND.	COLOR
1 18 ga.	Black
2	White
1 22 ga.	Red
2	Green
3	Brown
4	Blue
5	Orange
6	Yellow
7	Violet



Multi-Conductor, Unshielded

UL 2464, UL 2576, NEC Type CM (UL) c(UL), CSA CMG

Product Construction:

Conductor:

- 24 AWG fully annealed stranded tinned copper per ASTM B-33

Insulation:

- Premium-grade, color-coded S-R PVC per UL 1061
- Color code: See charts below

Jacket:

- PVC, gray
- Temperature range: -20°C to +80°C

Applications:

- Public address systems
- Intercoms
- Internal telephones
- Remote control circuits
- Suitable for EIA RS-232 applications
- Suggested voltage rating: 300 volts

Features:

- Easy to terminate
- Excellent electrical properties
- Tinned conductors provide excellent corrosion resistance
- Assists soldering applications

Compliances:

- NEC Article 800 Type CM (UL: 75°C)
- UL Style 2464 (UL: 80°C, 300V)
- UL Style 2576 (UL: 80°C, 150V)
- CSA CMG (CSA: 60°C)
- RoHS Compliant Directive 2002/95/EC
- Designed to meet UL 70,000 BTU Vertical Tray Flame Test
- Passes CSA CMG Flame Test

Packaging:

- Please contact Customer Service for packaging and color options

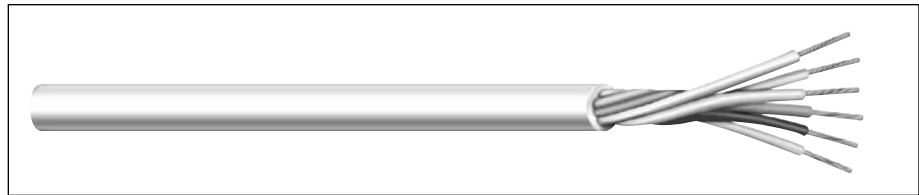

CATALOG NUMBER	NO. OF COND.	AWG SIZE	COND. STRAND	NOM. INSULATION THICKNESS		NOM. JACKET THICKNESS		NOMINAL O.D.		COLOR CODE	NOM. C-C CAP.* pF/ft
				INCHES	mm	INCHES	mm	INCHES	mm		
C2461A	2	24	7/32	0.010	0.25	0.032	0.81	0.152	3.86	Black/Red	23.0
C2462A	3	24	7/32	0.010	0.25	0.032	0.81	0.163	4.14	Black/Red/Green	23.0
C2463A	4	24	7/32	0.010	0.25	0.032	0.81	0.174	4.42	1	23.0
C2464A	5	24	7/32	0.010	0.25	0.032	0.81	0.183	4.75	1	23.0
C2466A	6	24	7/32	0.010	0.25	0.032	0.81	0.200	5.08	1	23.0
C2488A	7	24	7/32	0.010	0.25	0.032	0.81	0.200	5.08	1	23.0
C2465A	8	24	7/32	0.010	0.25	0.032	0.81	0.214	5.44	1	23.0
C2470A	9	24	7/32	0.010	0.25	0.032	0.81	0.227	5.77	1	23.0
C2471A	10	24	7/32	0.010	0.25	0.032	0.81	0.244	6.20	1	23.0
C2467A	12	24	7/32	0.010	0.25	0.032	0.81	0.251	6.38	1	23.0
C2473A	15	24	7/32	0.010	0.25	0.032	0.81	0.275	6.99	2	23.0

*Capacitance between conductors

Color Code Chart 1 - For cables up to and including 12 conductors

NO. OF COND.	COLOR	NO. OF COND.	COLOR
1	Black	7	Orange
2	White	8	Yellow
3	Red	9	Violet
4	Green	10	Gray
5	Brown	11	Pink
6	Blue	12	Tan

Color Code Chart 2 Per ICEA - For cables with 15 conductors

NO. OF COND.	COLOR	NO. OF COND.	COLOR	NO. OF COND.	COLOR
1	Black	6	Blue	11	Blue/Black
2	White	7	White/Black	12	Black/White
3	Red	8	Red/Black	13	Red/White
4	Green	9	Green/Black	14	Green/White
5	Orange	10	Orange/Black	15	Blue/White

Multi-Conductor, Unshielded

UL 2464, UL 2576, NEC Type CM (UL) c(UL), CSA CMG

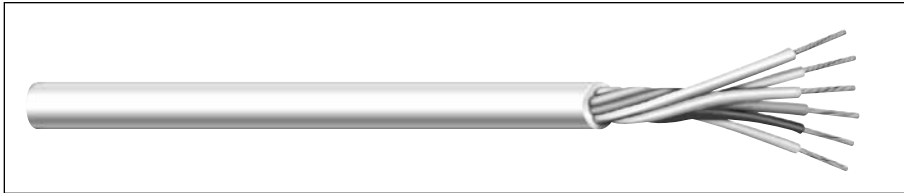

Product Construction:

Conductor:

- 22 AWG fully annealed, stranded tinned copper per ASTM B-33

Insulation:

- Premium-grade, color-coded S-R PVC per UL 1061
- Color code: See charts below

Jacket:

- PVC, gray
- Temperature range: -20°C to +80°C

Applications:

- Public address systems
- Intercoms
- Internal telephones
- Remote control circuits
- Suitable for EIA RS-232 applications
- Suggested voltage rating: 300 volts

Features:

- Easy to terminate
- Excellent electrical properties
- Tinned conductors provide excellent corrosion resistance
- Assists soldering applications

Compliances:

- NEC Article 800 Type CM (UL: 75°C)
- UL Style 2464 (UL: 80°C, 300V)
- UL Style 2576 (UL: 80°C, 150V)
- CSA CMG (CSA 60°C)
- RoHS Compliant Directive 2002/95/EC
- Designed to meet UL 70,000 BTU Vertical Tray Flame Test
- Passes CSA CMG Flame Test

Packaging:

- Please contact Customer Service for packaging and color options

CATALOG NUMBER	NO. OF COND.	AWG SIZE	COND. STRAND	NOM. INSULATION THICKNESS		NOM. JACKET THICKNESS		NOMINAL O.D.		COLOR CODE	NOM. C-C CAP* pF/ft
				INCHES	mm	INCHES	mm	INCHES	mm		
C6348A†	2	22	7/30	0.010	0.25	0.015	0.38	0.130	3.30	Black/Red	24.5
C4062A	3	22	7/30	0.010	0.25	0.032	0.81	0.176	4.47	Black/Red/Green	24.5
C4063A	4	22	7/30	0.010	0.25	0.032	0.81	0.189	4.80	1	24.5
C4064A	5	22	7/30	0.010	0.25	0.032	0.81	0.203	5.16	1	24.5
C4066A	6	22	7/30	0.010	0.25	0.032	0.81	0.218	5.54	1	24.5
C4088A	7	22	7/30	0.010	0.25	0.032	0.81	0.205	5.54	1	24.5
C4065A	8	22	7/30	0.010	0.25	0.032	0.81	0.230	5.94	1	24.5
C4070A	9	22	7/30	0.010	0.25	0.032	0.81	0.249	6.32	1	24.5
C4071A	10	22	7/30	0.010	0.25	0.032	0.81	0.268	6.81	1	24.5
C4067A	12	22	7/30	0.010	0.25	0.032	0.81	0.276	7.01	1	24.5
C4073A	15	22	7/30	0.010	0.25	0.032	0.81	0.303	7.70	2	24.5
C4075A	20	22	7/30	0.010	0.25	0.032	0.81	0.334	8.48	2	24.5
C4076A	25	22	7/30	0.010	0.25	0.032	0.81	0.368	9.35	2	24.5
C4077A	30	22	7/30	0.010	0.25	0.032	0.81	0.389	9.88	2	24.5
C4078A	40	22	7/30	0.010	0.25	0.032	0.81	0.434	11.02	2	24.5
C4079A	50	22	7/30	0.010	0.25	0.032	0.81	0.489	12.42	2	24.5

*Capacitance between conductors

†CM-CSA CMG Only

Color Code Chart 1 - For cables up to and including 12 conductors

NO. OF COND.	COLOR	NO. OF COND.	COLOR
1	Black	7	Orange
2	White	8	Yellow
3	Red	9	Violet
4	Green	10	Gray
5	Brown	11	Pink
6	Blue	12	Tan

Color Code Chart 2 Per ICEA - For cables of 15 thru 50 conductors

NO. OF COND.	COLOR	NO. OF COND.	COLOR	NO. OF COND.	COLOR	NO. OF COND.	COLOR
1	Black	14	Green/White	27	Blue/Black/White	39	White/Black/Green
2	White	15	Blue/White	28	Black/Red/Green	40	Red/White/Green
3	Red	16	Black/Red	29	White/Red/Green	41	Green/White/Blue
4	Green	17	White/Red	30	Red/Black/Green	42	Orange/Red/Green
5	Orange	18	Orange/Red	31	Green/Black/Orange	43	Blue/Red/Green
6	Blue	19	Blue/Red	32	Orange/Black/Green	44	Black/White/Blue
7	White/Black	20	Red/Green	33	Blue/White/Orange	45	White/Black/Blue
8	Red/Black	21	Orange/Green	34	Black/White/Orange	46	Red/White/Blue
9	Green/Black	22	Black/White/Red	35	White/Red/Orange	47	Green/Orange/Red
10	Orange/Black	23	White/Black/Red	36	Orange/White/Blue	48	Orange/Red/Blue
11	Blue/Black	24	Red/Black/White	37	White/Red/Blue	49	Blue/Red/Orange
12	Black/White	25	Green/Black/White	38	Black/White/Green	50	Black/Orange/Red
13	Red/White	26	Orange/Black/White				



Multi-Conductor, Unshielded

UL 2464, UL 2576, NEC Type CM (UL) c(UL), CSA CMG

Product Construction:

Conductor:

- 20 or 18 AWG fully annealed stranded, tinned copper per ASTM B-33

Insulation:

- Premium-grade, color-coded PVC per UL 1007
- Color code: See charts below

Jacket:

- PVC, gray
- Temperature range: -20°C to +80°C

Applications:

- Public address systems
- Intercoms
- Internal telephones
- Remote control circuits
- Suitable for EIA RS-232 applications
- Suggested voltage rating: 300 volts

Compliances:

- NEC Article 800 Type CM (UL: 75°C)
- UL Style 2464 (UL: 80°C, 300V)
- UL Style 2576 (UL: 80°C, 150V)
- CSA CMG (CSA: 60°C)
- RoHS Compliant Directive 2002/95/EC
- Designed to meet UL 70,000 BTU Vertical Tray Flame Test
- Passes CSA CMG Flame Test

Packaging:

- Please contact Customer Service for packaging and color options

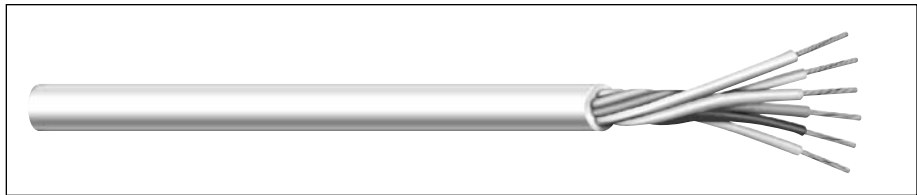

CATALOG NUMBER	NO. OF COND.	AWG SIZE	COND. STRAND	NOM. INSULATION THICKNESS		NOM. JACKET THICKNESS		NOMINAL O.D.		COLOR CODE	NOM. C-C CAP.* pF/ft
				INCHES	mm	INCHES	mm	INCHES	mm		
C6351A†	2	20	7/28	0.016	0.41	0.025	0.64	0.192	4.88	Black/Red	28.0
C6352A	3	20	7/28	0.016	0.41	0.032	0.81	0.216	5.50	1	28.0
C6353A	4	20	7/28	0.016	0.41	0.032	0.81	0.235	5.97	1	28.0
C6355A	5	20	7/28	0.016	0.41	0.032	0.81	0.254	6.46	1	28.0
C6356A	7	20	7/28	0.016	0.41	0.032	0.81	0.275	6.99	1	28.0
C6357A	9	20	7/28	0.016	0.41	0.032	0.81	0.317	8.05	1	28.0
C6360A	12	20	7/28	0.016	0.41	0.032	0.81	0.354	9.00	2	28.0
C6358A	15	20	7/28	0.016	0.41	0.032	0.81	0.392	9.96	2	28.0
C2830A†	2	18	16/30	0.016	0.41	0.015	0.64	0.190	5.33	Black/Red	30.5
C2831A	3	18	16/30	0.016	0.41	0.032	0.81	0.236	5.99	1	30.5
C2404A	4	18	16/30	0.016	0.41	0.032	0.81	0.258	6.55	1	30.5
C2420A	5	18	16/30	0.016	0.41	0.032	0.81	0.280	7.11	1	30.5
C2421A	7	18	16/30	0.016	0.41	0.032	0.81	0.309	7.85	1	30.5
C2422A	9	18	16/30	0.016	0.41	0.032	0.81	0.358	9.09	1	30.5
C2412A	12	18	16/30	0.016	0.41	0.032	0.81	0.401	10.19	2	30.5
C2423A	15	18	16/30	0.016	0.41	0.032	0.81	0.445	11.30	2	30.5
C2424A	19	18	16/30	0.016	0.41	0.032	0.81	0.469	11.91	2	30.5
C2433A	25	18	16/30	0.016	0.41	0.032	0.81	0.550	13.94	2	30.5

*Capacitance between conductors
†CM (UL) c(UL), CSA CMG Only

Color Code Chart 1 - For cables up to and including 9 conductors

NO. OF COND.	COLOR	NO. OF COND.	COLOR
1	Black	6	Blue
2	White	7	Orange
3	Red	8	Yellow
4	Green	9	Violet
5	Brown		

Color Code Chart 2 Per ICEA - For cables of 12 thru 25 conductors

NO. OF COND.	COLOR	NO. OF COND.	COLOR	NO. OF COND.	COLOR
1	Black	10	Orange/Black	19	Blue/Red
2	White	11	Blue/Black	20	Red/Green
3	Red	12	Black/White	21	Orange/Green
4	Green	13	Red/White	22	Black/White/Red
5	Orange	14	Green/White	23	White/Black/Red
6	Blue	15	Blue/White	24	Red/Black/White
7	White/Black	16	Black/Red	25	Green/Black/White
8	Red/Black	17	White/Red		
9	Green/Black	18	Orange/Red		



Multi-Conductor, Unshielded

UL 2464, UL 2587, NEC Type CL3 and CM (UL) c(UL), CSA CMG

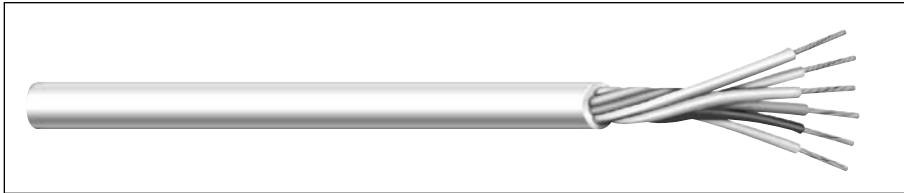

Product Construction:

Conductor:

- 16 thru 12 AWG fully annealed stranded tinned copper per ASTM B-33

Insulation:

- Premium-grade, color-coded PVC
- Color code: See chart below

Jacket:

- PVC, gray
- Temperature range: -20°C to +90°C

Applications:

- Public address systems
- Intercoms
- Internal telephones
- Remote control circuits
- Suitable for EIA RS-232 applications
- Suggested voltage rating: 300 volts

Compliances:

- NEC Article 725 Type CL3 (UL: 75°C)
- NEC Article 800 Type CM (UL: 75°C)
- UL Style 2464 (UL: 80°C, 300V)
- UL Style 2587 (UL: 90°C, 600V)
- CSA CMG (CSA: 60°C)
- RoHS Compliant Directive 2002/95/EC
- Designed to meet UL 70,000 BTU Vertical Tray Flame Test
- Passes CSA CMG Flame Test

Packaging:

- Please contact Customer Service for packaging and color options

CATALOG NUMBER	NO. OF COND.	AWG SIZE	COND. STRAND	NOM. INSULATION THICKNESS		NOM. JACKET THICKNESS		NOMINAL O.D.		NOM. C-C CAP* pF/ft
				INCHES	mm	INCHES	mm	INCHES	mm	

NEC TYPE CM, UL STYLE 2464 (80°C, 300 VOLTS)

C2405A	2	16	19/.0117	0.021	0.53	0.032	0.81	0.260	6.81	30.5
C2406A	3	16	19/.0117	0.021	0.53	0.032	0.81	0.283	7.19	30.5
C2425A	4	16	19/.0117	0.021	0.53	0.032	0.81	0.306	7.77	30.5
C2434A	5	16	19/.0117	0.021	0.53	0.032	0.81	0.334	8.48	30.5
C2426A	7	16	19/.0117	0.021	0.53	0.032	0.81	0.363	9.25	30.5
C2443A	8	16	19/.0117	0.021	0.53	0.032	0.81	0.393	10.03	30.5
C2435A	9	16	19/.0117	0.021	0.53	0.032	0.81	0.423	10.80	30.5
C2427A	12	16	19/.0117	0.021	0.53	0.032	0.81	0.476	12.17	30.5
C2428A	15	16	19/.0117	0.021	0.53	0.032	0.81	0.530	13.46	30.5
C2429A	19	16	19/.0117	0.021	0.53	0.032	0.81	0.559	14.33	30.5
C2436A	25	16	19/.0117	0.021	0.53	0.032	0.81	0.657	16.69	30.5

NEC TYPE CL3, UL STYLE 2587 (90°C, 600 VOLTS)

C2409A†	2	14	19/.0147	0.030	0.81	0.032	0.81	0.326	8.51	29.0
C2430A	4	14	19/.0147	0.032	0.81	0.032	0.81	0.391	9.93	28.2
C2437A	5	14	19/.0147	0.032	0.81	0.032	0.81	0.428	10.87	28.2
C2431A	7	14	19/.0147	0.032	0.81	0.032	0.81	0.469	11.91	28.2
C2410A	2	12	19/0.0185	0.032	0.81	0.032	0.81	0.366	9.40	31.0
C2440A	4	12	19/0.0185	0.032	0.81	0.032	0.81	0.437	11.02	31.0

*Capacitance between conductors
†CL3, UL2587, CSA CMH Only

Color Code Chart Per ICEA

NO. OF COND.	COLOR	NO. OF COND.	COLOR	NO. OF COND.	COLOR
1	Black	10	Orange/Black	19	Blue/Red
2	White	11	Blue/Black	20	Red/Green
3	Red	12	Black/White	21	Orange/Green
4	Green	13	Red/White	22	Black/White/Red
5	Orange	14	Green/White	23	White/Black/Red
6	Blue	15	Blue/White	24	Red/Black/White
7	White/Black	16	Black/Red	25	Green/Black/White
8	Red/Black	17	White/Red		
9	Green/Black	18	Orange/Red		



Multi-Conductor, Unshielded

NEC Type CMP (UL) c(UL)

Product Construction:

Conductor:

- 18 AWG fully annealed stranded tinned copper per ASTM B-33

Insulation:

- Premium-grade, color-coded FEP
- Color code: See chart below

Jacket:

- Flexguard® PVC, natural or as requested
- Temperature range: -20°C to +75°C

Applications:

- Audio systems
- Remote control circuits
- Process control and instrumentation
- Suggested voltage rating: 300 volts

Compliances:

- NEC Article 800 (UL: 75°C, 300V)
- Designed to meet NFPA 262 and CSA FT-6 Steiner Tunnel Fire Tests for Plenum Applications

Features:

- Fire-retardant, low-smoke jacket

Packaging:

- Please contact Customer Service for packaging and color options

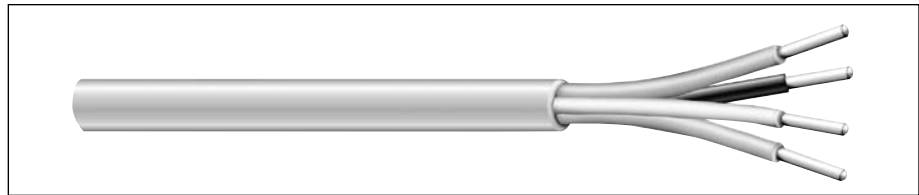

CATALOG NUMBER	NO. OF COND.	AWG SIZE	COND. STRAND	NOM. INSULATION THICKNESS		NOM. JACKET THICKNESS		NOMINAL O.D.		NOM. C-C CAP.* pF/ft
				INCHES	mm	INCHES	mm	INCHES	mm	
C8102	4	18	19/30 TC	0.007	0.18	0.014	0.36	0.178	4.52	21.5

*Capacitance between conductors

Color Code Chart

NO. OF COND.	COLOR
1	Black
2	White
3	Red
4	Green

Multi-Conductor, Unshielded

NEC Type CMP (UL) c(UL) and/or CL2P

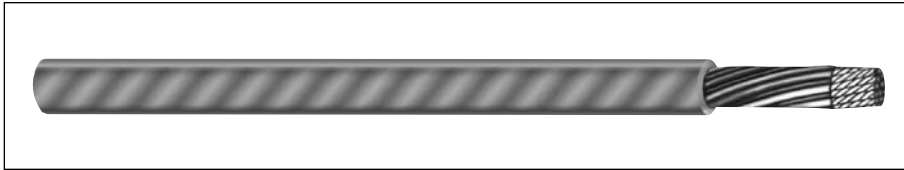

CATALOG NUMBER	NO. OF COND.	AWG SIZE	COND. STRAND	NOM. INSULATION THICKNESS		NOM. JACKET THICKNESS		NOMINAL O.D.		NOM. C-C CAP* pF/ft
				INCHES	mm	INCHES	mm	INCHES	mm	

22 AWG CONDUCTORS

C3105†	2	22	7/30 TC	0.006	0.15	0.010	0.25	0.089	2.26	29.0
C3106†	4	22	7/30 TC	0.006	0.15	0.010	0.25	0.121	3.07	29.0

18 AWG CONDUCTORS

C3102	2	18	7/26 BC	0.008	0.20	0.010	0.25	0.123	3.12	31.0
C3190	3	18	7/26 BC	0.008	0.20	0.010	0.25	0.143	3.63	31.0
C3103	4	18	7/26 BC	0.008	0.20	0.010	0.25	0.163	4.14	31.0
C3134	5	18	7/26 BC	0.008	0.20	0.010	0.25	0.187	4.75	30.8
C3192	6	18	7/26 BC	0.008	0.20	0.010	0.25	0.198	5.03	31.0
C3191	8	18	7/26 BC	0.008	0.20	0.010	0.25	0.223	5.66	31.0
C3178	10	18	7/26 BC	0.008	0.20	0.010	0.25	0.244	6.19	31.0
C3179	12	18	7/26 BC	0.008	0.20	0.010	0.25	0.263	6.68	31.0

16 AWG CONDUCTORS

C3193	2	16	19/.0117 BC	0.008	0.20	0.010	0.25	0.141	3.58	33.0
C3194	3	16	7/.0192 BC	0.008	0.20	0.010	0.25	0.164	4.17	33.0
C3195	4	16	7/.0192 BC	0.008	0.20	0.010	0.25	0.187	4.75	33.0

14 AWG CONDUCTORS

C3126†	2	14	19/.0147 BC	0.010	0.25	0.010	0.25	0.168	4.27	35.0
---------------	---	----	-------------	-------	------	-------	------	-------	------	------

12 AWG CONDUCTORS

C3135†	2	12	19/.0185 BC	0.010	0.25	0.010	0.25	0.238	6.05	37.0
---------------	---	----	-------------	-------	------	-------	------	-------	------	------

*Capacitance between conductors

†CL2P only

Color Code Chart

NO. OF COND.	COLOR
1	Black
2	White
3	Red
4	Green
5	Brown
6	Blue
7	Orange
8	Yellow
9	Violet
10	Gray
11	Pink
12	Tan

Product Construction:

Conductor:

- 22 thru 14 AWG fully annealed stranded tinned or bare copper per ASTM B-3, B-8 or B-33

Insulation:

- Premium-grade, color-coded Flexguard® PVC
- Color code: See chart below

Jacket:

- Fluoropolymer, natural
- Temperature range: -20°C to +75°C
- Sequential footage marked to facilitate installation
- Includes ripcord

Applications:

- Intercom systems
- Background music
- Audio systems
- Power-limited control circuits
- Suggested voltage rating: 150 volts

Compliances:

- NEC Article 725 (UL: 75°C, 150V)
- NEC Article 800 (UL: 75°C, 300V)
- Designed to meet NFPA 262 and CSA FT-6 Steiner Tunnel Fire Tests for Plenum Applications

Features:

- Abrasion-, chemical- and water-resistant jacket

Packaging:

- Please contact Customer Service for packaging and color options



Designed to Meet
NFPA 262 and CSA FT-6
Steiner Tunnel Fire Tests
for Plenum Applications

Underwriters Laboratories Inc.



Multi-Conductor, Unshielded

NEC Type CMP (UL) c(UL) and/or CL3P

Product Construction:

Conductor:

- 22 thru 12 AWG fully annealed solid, stranded tinned or bare copper per ASTM B-3, B-8 or B-33

Insulation:

- Premium-grade, color-coded Flexguard® PVC
- Color code: See chart below

Jacket:

- Flexguard® PVC, natural
- Temperature range: 0°C to +75°C
- Sequential footage marked to facilitate installation
- Includes ripcord

Applications:

- Intercom systems
- Background music
- Audio systems
- Power-limited control circuits
- Suggested voltage rating: 150 volts

Compliances:

- NEC Article 725 (UL: 75°C, 150V)
- NEC Article 800 (UL: 75°C, 300V)
- Designed to meet NFPA 262 and CSA FT-6 Steiner Tunnel Fire Tests for Plenum Applications

Features:

- Flexible
- Easy to terminate

Packaging:

- Please contact Customer Service for packaging and color options

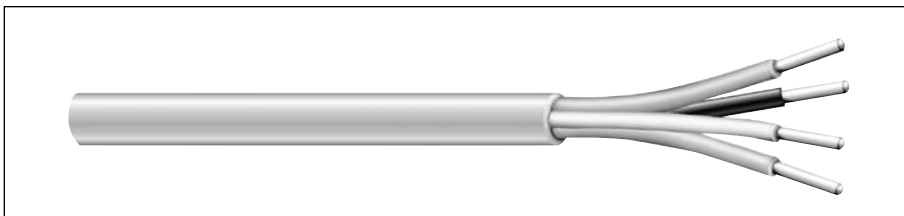

CATALOG NUMBER	NO. OF COND.	AWG SIZE	COND. STRAND	NOM. INSULATION THICKNESS		NOM. JACKET THICKNESS		NOMINAL O.D.		NOM.* C-C CAP. pF/ft
				INCHES	mm	INCHES	mm	INCHES	mm	

22 AWG CONDUCTORS

C3115	2	22	7/32 TC	0.008	0.20	0.015	0.38	0.122	3.10	30.0
C3116	4	22	7/32 TC	0.008	0.20	0.015	0.38	0.141	3.58	30.0

18 AWG CONDUCTORS

C3110	2	18	Solid BC	0.008	0.20	0.015	0.38	0.142	3.61	37.0
C3114	3	18	Solid BC	0.008	0.20	0.015	0.38	0.151	3.84	37.0
C3111	4	18	Solid BC	0.008	0.20	0.015	0.38	0.166	4.22	37.0
C3117	5	18	Solid BC	0.008	0.20	0.015	0.38	0.182	4.62	37.0
C3118	6	18	Solid BC	0.008	0.20	0.015	0.38	0.199	5.05	37.0
C3119	8	18	Solid BC	0.008	0.20	0.015	0.38	0.216	5.49	37.0
C3112	2	18	7/26 BC	0.008	0.20	0.015	0.38	0.156	3.96	35.0
C3120	3	18	7/26 BC	0.008	0.20	0.015	0.38	0.166	4.22	35.0
C3113	4	18	7/26 BC	0.008	0.20	0.015	0.38	0.182	4.62	35.0
C3125	5	18	7/26 BC	0.008	0.20	0.015	0.38	0.200	5.08	54.6
C3121	6	18	7/26 BC	0.008	0.20	0.015	0.38	0.216	5.49	35.0
C3122	8	18	7/26 BC	0.008	0.20	0.015	0.38	0.239	6.07	35.0
C3123	10	18	7/26 BC	0.008	0.20	0.015	0.38	0.278	7.06	35.0
C3124	12	18	7/26 BC	0.008	0.20	0.015	0.38	0.287	7.29	35.0

16 AWG CONDUCTORS

C3127	2	16	19/.0117 BC	.009	.227	0.015	0.38	0.178	4.52	40.0
--------------	---	----	-------------	------	------	-------	------	-------	------	------

14 AWG CONDUCTORS

C3128†	2	14	19/.0147 BC	0.010	0.20	0.015	0.38	0.212	5.38	40.0
---------------	---	----	-------------	-------	------	-------	------	-------	------	------

12 AWG CONDUCTORS

C3129†	2	12	19/.0185 BC	0.010	0.20	0.015	0.38	0.254	6.45	43.0
---------------	---	----	-------------	-------	------	-------	------	-------	------	------

*Capacitance between conductors

†CL3P only

Color Code Chart

NO. OF COND.	COLOR
1	Black
2	White
3	Red
4	Green
5	Brown
6	Blue
7	Orange
8	Yellow

Multi-Conductor, Unshielded

AWM Style 2464, CSA Type AWM I/II A/B, NEC/CEC Type CMG (CSA C/US)

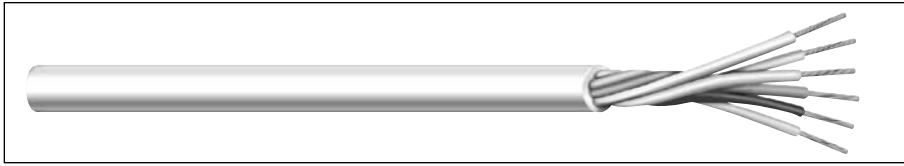

CATALOG NUMBER	NO. OF COND.	AWG SIZE	COND. STRAND	NOM. INSULATION THICKNESS		NOM. JACKET THICKNESS		NOMINAL O.D.		COLOR CODE	NOM. C-C CAP* pF/ft
				INCHES	mm	INCHES	mm	INCHES	mm		
C4100A	2	22	7/30	0.010	0.25	0.032	0.81	0.165	4.19	Black/Red	27.5
C4101A	3	22	7/30	0.010	0.25	0.032	0.81	0.176	4.47	Black/Red/Green	27.5
C4102A	4	22	7/30	0.010	0.25	0.032	0.81	0.189	4.80	1	27.5
C4103A	5	22	7/30	0.010	0.25	0.032	0.81	0.203	5.16	1	27.5
C4104A	6	22	7/30	0.010	0.25	0.032	0.81	0.208	5.28	1	27.5
C4105A	7	22	7/30	0.010	0.25	0.032	0.81	0.218	5.54	1	27.5
C4106A	8	22	7/30	0.010	0.25	0.032	0.81	0.234	5.94	1	27.5
C4107A	9	22	7/30	0.010	0.25	0.032	0.81	0.249	6.32	1	27.5
C4108A	10	22	7/30	0.010	0.25	0.032	0.81	0.268	6.81	1	27.5
C4109A	12	22	7/30	0.010	0.25	0.032	0.81	0.276	7.01	1	27.5
C4110A	15	22	7/30	0.010	0.25	0.032	0.81	0.303	7.70	2	27.5
C4111A	18	22	7/30	0.010	0.25	0.032	0.81	0.318	8.08	2	27.5
C4112A	20	22	7/30	0.010	0.25	0.032	0.81	0.334	8.48	2	27.5
C4113A	25	22	7/30	0.010	0.25	0.032	0.81	0.368	9.35	2	27.5
C4114A	30	22	7/30	0.010	0.25	0.032	0.81	0.389	9.88	2	27.5
C4115A	40	22	7/30	0.010	0.25	0.032	0.81	0.434	11.02	2	27.5
C4116A	50	22	7/30	0.010	0.25	0.032	0.81	0.489	12.42	2	27.5

*Capacitance between conductors

Color Code Chart 1- For cables up to and including 12 conductors

NO. OF COND.	COLOR	NO. OF COND.	COLOR
1	Black	7	Orange
2	White	8	Yellow
3	Red	9	Violet
4	Green	10	Gray
5	Brown	11	Pink
6	Blue	12	Tan

Color Code Chart 2 Per ICEA - For cables of 15 thru 50 conductors

NO. OF COND.	COLOR	NO. OF COND.	COLOR	NO. OF COND.	COLOR
1	Black	18	Orange/Red	35	White/Red/Orange
2	White	19	Blue/Red	36	Orange/White/Blue
3	Red	20	Red/Green	37	White/Red/Blue
4	Green	21	Orange/Green	38	Black/White/Green
5	Orange	22	Black/White/Red	39	White/Black/Green
6	Blue	23	White/Black/Red	40	Red/White/Green
7	White/Black	24	Red/Black/White	41	Green/White/Blue
8	Red/Black	25	Green/Black/White	42	Orange/Red/Green
9	Green/Black	26	Orange/Black/White	43	Blue/Red/Green
10	Orange/Black	27	Blue/Black/White	44	Black/White/Blue
11	Blue/Black	28	Black/Red/Green	45	White/Black/Blue
12	Black/White	29	White/Red/Green	46	Red/White/Blue
13	Red/White	30	Red/Black/Green	47	Green/Orange/Red
14	Green/White	31	Green/Black/Orange	48	Orange/Red/Blue
15	Blue/White	32	Orange/Black/Green	49	Blue/Red/Orange
16	Black/Red	33	Blue/White/Orange	50	Black/Orange/Red
17	White/Red	34	Black/White/Orange		

Product Construction:

Conductor:

- 22 AWG fully annealed, stranded tinned copper per ASTM B-33

Insulation:

- Premium-grade, color-coded PVC
- Color code: See charts below

Jacket:

- PVC, gray
- Temperature range: -20°C to +105°C

Applications:

- Public address systems
- Intercoms
- Internal telephones
- Remote control circuits
- Suitable for EIA RS-232 applications
- Suggested voltage rating: 300 or 600 volts

Features:

- Easy to terminate
- Excellent electrical properties
- Tinned conductors provide excellent corrosion resistance
- Assists soldering applications

Compliances:

- AWM Style 2464 (CSA: 80°C, 300V)
- CSA Type AWM (105°C, 600V)
- CSA Certified CMG to harmonized standard UL444 and CSA 22.2 No. 214
- NEC/CEC Type CMG (CSA: 105°C, 300V)
- RoHS Compliant Directive 2002/95/EC
- Designed to meet CSA 70,000 BTU Vertical Tray Flame Test
- Passes CSA FT4 vertical flame test

Packaging:

- Please contact Customer Service for packaging and color options



Multi-Conductor, Unshielded

AWM Style 2464, CSA Type AWM I/II A/B, NEC/CEC Type CMG (CSA C/US)

Product Construction:

Conductor:

- 20 or 18 AWG fully annealed, stranded tinned copper per ASTM B-33

Insulation:

- Premium-grade, color-coded PVC
- Color code: See charts below

Jacket:

- PVC, gray
- Temperature range: -20°C to +105°C

Applications:

- Public address systems
- Intercoms
- Internal telephones
- Remote control circuits
- Suitable for EIA RS-232 applications
- Suggested voltage rating: 300 or 600 volts

Features:

- Easy to terminate
- Excellent electrical properties
- Tinned conductors provide excellent corrosion resistance
- Assists soldering applications

Compliances:

- AWM Style 2464 (CSA: 80°C, 300V)
- CSA Type AWM (105°C, 600V)
- CSA Certified CMG to harmonized standard UL444 and CSA 22.2 No. 214
- NEC/CEC Type CMG (CSA: 105°C, 300V)
- RoHS Compliant Directive 2002/95/EC
- Designed to meet CSA 70,000 BTU Vertical Tray Flame Test
- Passes CSA FT4 vertical flame test

Packaging:

- Please contact Customer Service for packaging and color options

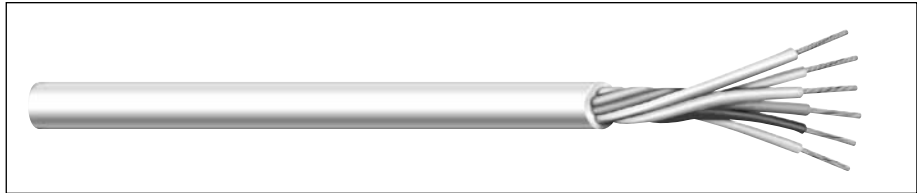

CATALOG NUMBER	NO. OF COND.	AWG SIZE	COND. STRAND	NOM. INSULATION THICKNESS		NOM. JACKET THICKNESS		NOMINAL O.D.		COLOR CODE	NOM. C-C CAP* pF/ft
				INCHES	mm	INCHES	mm	INCHES	mm		
C4117A	2	20	7/28	0.016	0.41	0.032	0.81	0.206	5.23	Black/Red	25.0
C4118A	3	20	7/28	0.016	0.41	0.032	0.81	0.216	5.49	1	25.0
C4119A	4	20	7/28	0.016	0.41	0.032	0.81	0.235	5.97	1	25.0
C4120A	5	20	7/28	0.016	0.41	0.032	0.81	0.254	6.45	1	25.0
C4121A	7	20	7/28	0.016	0.41	0.032	0.81	0.275	6.99	1	25.0
C4122A	9	20	7/28	0.016	0.41	0.032	0.81	0.317	8.05	1	25.0
C4123A	12	20	7/28	0.016	0.41	0.032	0.81	0.354	8.99	2	25.0
C4124A	15	20	7/28	0.016	0.41	0.032	0.81	0.392	9.96	2	25.0
C4125A	2	18	16/30	0.016	0.41	0.032	0.81	0.224	5.69	Black/Red	27.5
C4214A	2	18	16/30	0.016	0.41	0.032	0.81	0.224	5.69	1	27.5
C4126A	3	18	16/30	0.016	0.41	0.032	0.81	0.236	5.99	1	27.5
C4127A	4	18	16/30	0.016	0.41	0.032	0.81	0.258	6.55	1	27.5
C4128A	5	18	16/30	0.016	0.41	0.032	0.81	0.280	7.11	1	27.5
C4206A	6	18	16/30	0.016	0.41	0.032	0.81	0.304	7.72	1	27.5
C4129A	7	18	16/30	0.016	0.41	0.032	0.81	0.309	7.85	1	27.5
C4130A	9	18	16/30	0.016	0.41	0.032	0.81	0.358	9.09	1	27.5
C4131A	12	18	16/30	0.016	0.41	0.032	0.81	0.401	10.19	2	27.5
C4132A	15	18	16/30	0.016	0.41	0.032	0.81	0.445	11.30	2	27.5
C4133A	19	18	16/30	0.016	0.41	0.032	0.81	0.469	11.91	2	27.5
C4134A	25	18	16/30	0.016	0.41	0.032	0.81	0.549	13.94	2	27.5

*Capacitance between conductors

Color Code Chart 1 - For cables up to and including 9 conductors

NO. OF COND.	COLOR	NO. OF COND.	COLOR
1	Black	6	Blue
2	White	7	Orange
3	Red	8	Yellow
4	Green	9	Violet
5	Brown		

Color Code Chart 2 Per ICEA - For cables of 12 thru 25 conductors

NO. OF COND.	COLOR	NO. OF COND.	COLOR	NO. OF COND.	COLOR
1	Black	10	Orange/Black	19	Blue/Red
2	White	11	Blue/Black	20	Red/Green
3	Red	12	Black/White	21	Orange/Green
4	Green	13	Red/White	22	Black/White/Red
5	Orange	14	Green/White	23	White/Black/Red
6	Blue	15	Blue/White	24	Red/Black/White
7	White/Black	16	Black/Red	25	Green/Black/White
8	Red/Black	17	White/Red		
9	Green/Black	18	Orange/Red		

Multi-Conductor, Unshielded

AWM Styles 2464, 2587, CSA Type AWM I/II A/B, NEC/CEC Type CMG (CSA C/US), or NEC Type CL2

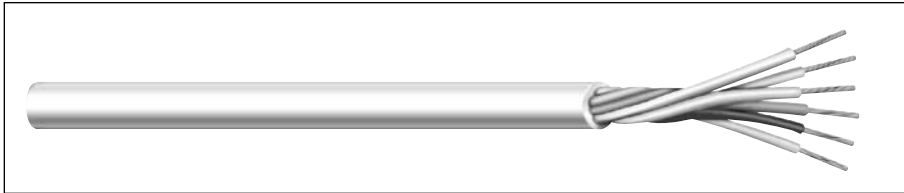

Product Construction:

Conductor:

- 16 thru 12 AWG fully annealed, stranded tinned copper per ASTM B-33

Insulation:

- Premium-grade, color-coded PVC
- Color code: See chart below

Jacket:

- PVC, gray
- Temperature range: -20°C to +105°C

Applications:

- Public address systems
- Intercoms
- Internal telephones
- Remote control circuits
- Suitable for EIA RS-232 applications
- Suggested voltage rating: 300 or 600 volts

Features:

- Easy to terminate
- Excellent electrical properties
- Tinned conductors provide excellent corrosion resistance
- Assists soldering applications

Compliances:

- AWM Style 2464 (CSA or UL: 80°C, 300V)
- AWM Style 2587 (CSA: 90°C, 600V)
- CSA Type AWM (105°C, 600V)
- CSA Certified CMG to harmonized standard UL444 and CSA 22.2 No. 214
- NEC/CEC Type CMG (CSA: 105°C, 300V)
- RoHS Compliant Directive 2002/95/EC
- Designed to meet CSA 70,000 BTU Vertical Tray Flame Test
- Passes CSA FT4 Vertical Flame Test
- UL Certified CL2 to Standard UL13**
- Designed to meet UL 70,000 BTU Vertical Tray Flame Test

CATALOG NUMBER	NO. OF COND.	AWG SIZE	COND. STRAND	NOM. INSULATION THICKNESS		NOM. JACKET THICKNESS		NOMINAL O.D.		NOM. C-C CAP* pF/ft
				INCHES	mm	INCHES	mm	INCHES	mm	

AWM STYLE 2464, CSA TYPE AWM, CSA C/US TYPE CMG

C4135A	2	16	19/.0117	0.021	0.53	0.032	0.81	0.268	6.81	27.0
C4136A	3	16	19/.0117	0.021	0.53	0.032	0.81	0.283	7.19	27.0
C4137A	4	16	19/.0117	0.021	0.53	0.032	0.81	0.306	7.77	27.0
C4138A	5	16	19/.0117	0.021	0.53	0.032	0.81	0.334	8.48	27.0
C4139A	7	16	19/.0117	0.021	0.53	0.032	0.81	0.364	9.25	27.0
C4140A	8	16	19/.0117	0.021	0.53	0.032	0.81	0.395	10.03	27.0
C4141A	9	16	19/.0117	0.021	0.53	0.032	0.81	0.425	10.80	27.0
C4142A	12	16	19/.0117	0.021	0.53	0.032	0.81	0.479	12.17	27.0
C4143A	15	16	19/.0117	0.021	0.53	0.032	0.81	0.530	13.46	27.0
C4144A	19	16	19/.0117	0.021	0.53	0.032	0.81	0.564	14.33	27.0
C4145A	25	16	19/.0117	0.021	0.53	0.032	0.81	0.657	16.69	27.0

AWM STYLE 2587, CSA TYPE AWM (FT4), NEC TYPE CL2**

C4146A	2	14	19/.0147	0.032	0.81	0.032	0.81	0.334	8.48	25.0
C4147A	4	14	19/.0147	0.032	0.81	0.032	0.81	0.391	9.93	25.0
C4148A	5	14	19/.0147	0.032	0.81	0.032	0.81	0.428	10.87	25.0
C4149A	7	14	19/.0147	0.032	0.81	0.032	0.81	0.469	11.91	25.0
C4150A	2	12	19/.0185	0.032	0.81	0.032	0.81	0.370	9.40	29.4
C4151A	4	12	19/.0185	0.032	0.81	0.032	0.81	0.434	11.02	29.4

* Capacitance between conductors

Color Code Chart Per ICEA

NO. OF COND.	COLOR	NO. OF COND.	COLOR	NO. OF COND.	COLOR
1	Black	10	Orange/Black	19	Blue/Red
2	White	11	Blue/Black	20	Red/Green
3	Red	12	Black/White	21	Orange/Green
4	Green	13	Red/White	22	Black/White/Red
5	Orange	14	Green/White	23	White/Black/Red
6	Blue	15	Blue/White	24	Red/Black/White
7	White/Black	16	Black/Red	25	Green/Black/White
8	Red/Black	17	White/Red		
9	Green/Black	18	Orange/Red		

Packaging:

- Please contact Customer Service for packaging and color options



Multi-Conductor, Rubber, Unshielded

Product Construction:

Conductor:

- 20 AWG fully annealed stranded tinned copper per ASTM B-33

Insulation:

- Premium-grade, color-coded rubber
- Color code: See chart below

Jacket:

- Rubber, black
- Temperature range: -20°C to +60°C

Applications:

- Energy management systems
- Control circuits
- Fire alarm control
- Broadcast and studio requirements
- Suggested voltage rating: 350 volts

Features:

- Excellent impact resistance
- High level of abrasion resistance
- High flexibility
- Excellent mechanical strength
- Excellent moisture resistance

Compliances:

- RoHS Compliant Directive 2002/95/EC

Packaging:

- Please contact Customer Service for packaging and color options

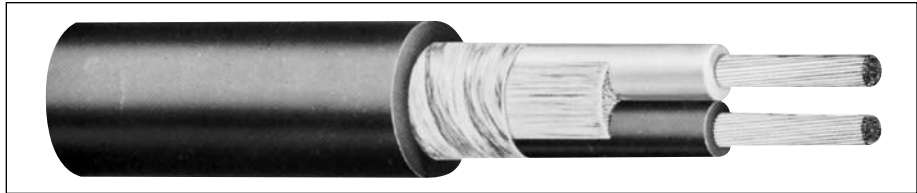

CATALOG NUMBER	NO. OF COND.	AWG SIZE	COND. STRAND	NOM. INSULATION THICKNESS		NOM. JACKET THICKNESS		NOMINAL O.D.	
				INCHES	mm	INCHES	mm	INCHES	mm
C3602	2	20	26/34	0.020	0.51	0.035	0.89	0.230	5.84
C3603	3	20	26/34	0.020	0.51	0.035	0.89	0.255	6.48
C3604	4	20	26/34	0.020	0.51	0.035	0.89	0.260	6.60
C3605	5	20	26/34	0.020	0.51	0.035	0.89	0.300	7.62
C3606	6	20	26/34	0.020	0.51	0.035	0.89	0.315	8.00
C3607	7	20	26/34	0.020	0.51	0.035	0.89	0.347	8.81
C3608	8	20	26/34	0.020	0.51	0.035	0.89	0.260	9.14
C3610	10	20	26/34	0.020	0.51	0.035	0.89	0.410	10.41

Color Code Chart

NO. OF COND.	COLOR
1	Black
2	White
3	Red
4	Green
5	Blue
6	Brown
7	Yellow
8	Orange
9	Gray
10	Violet

Power-Limited Tray Cable, Unshielded

NEC Type PLTC

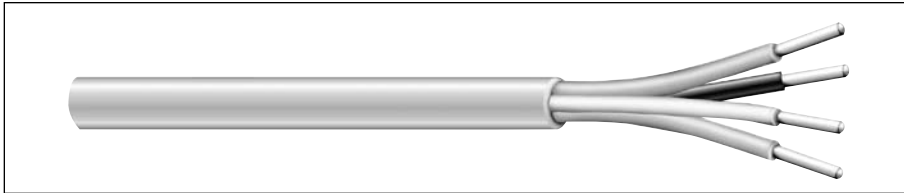

Product Construction:

Conductor:

- 22 thru 12 AWG fully annealed stranded tinned copper per ASTM B-33

Insulation:

- Premium-grade, color-coded PVC
- Color code: See chart below

Jacket:

- PVC, gray
- Temperature range: -20°C to +105°C

Applications:

- Cable tray installations
- Power limited circuits
- Intercom systems
- Business machines
- Cash registers
- Automatic valve control systems
- Irrigation systems
- Suggested voltage rating: 300 volts
- Burglar alarms

Features:

- Sunlight-resistant PVC jacket
- UL rated for cable tray use

Compliances:

- NEC Article 725 Power-Limited Tray Cable (UL: 105°C, 300V)
- RoHS Compliant Directive 2002/95/EC
- Meets UL 70,000 BTU Vertical Tray Flame Test

Packaging:

- Please contact Customer Service for packaging and color options

CATALOG NUMBER	NO. OF COND.	AWG SIZE	COND. STRAND	NOM. INSULATION THICKNESS		NOM. JACKET THICKNESS		NOMINAL O.D.		NOM. C-C CAP* pF/ft
				INCHES	mm	INCHES	mm	INCHES	mm	
C0431A	2	22	7/30	0.013	0.33	0.037	0.94	0.190	4.83	27.5
C0432A	3	22	7/30	0.013	0.33	0.037	0.94	0.198	5.03	27.5
C0433A	2	20	7/28	0.013	0.33	0.037	0.94	0.206	5.23	30.5
C0434A	3	20	7/28	0.013	0.33	0.037	0.94	0.216	5.49	30.5
C0435A	2	18	16/30	0.015	0.38	0.037	0.94	0.226	5.74	31.5
C0436A	3	18	16/30	0.015	0.38	0.037	0.94	0.237	6.02	31.5
C0444A	4	18	16/30	0.015	0.38	0.037	0.94	0.257	6.53	31.5
C0437A	2	16	19/.0117	0.013	0.33	0.037	0.94	0.243	6.17	37.0
C0438A	3	16	19/.0117	0.013	0.33	0.037	0.94	0.250	6.35	37.0
C0439A	2	14	19/.0147	0.013	0.33	0.042	1.07	0.288	7.32	40.5
C0440A	3	14	19/.0147	0.013	0.33	0.042	1.07	0.290	7.37	40.5
C0441A	2	12	19/.0185	0.013	0.33	0.042	1.07	0.315	8.00	44.0

*Capacitance between conductors

Color Code Chart

NO. OF COND.	COLOR
1	Black
2	Red
3	White
4	Green



Designed to Meet
UL Vertical Tray
Flame Test
Underwriters Laboratories Inc.



Multi-Conductor, Foil Shield

NEC Type CL2 and CM (UL) c(UL) CMH

Product Construction:

Conductor:

- 24 thru 12 AWG fully annealed solid or stranded tinned copper per ASTM B-33

Insulation:

- Premium-grade, color-coded polyethylene
- Premium-grade, color-coded polypropylene
- Color code: See charts below

Shield:

- 100% Flexfoil® aluminum/polyester, 25% overlap, foil facing out
- Stranded tinned copper drain wire

Jacket:

- PVC, gray
- Temperature range: -20°C to +75°C

Applications:

- Recording studios and sound stages
- Broadcast and sound systems
- Computers
- Industrial equipment control
- Suggested voltage rating: 300 or 600 volts

Features:

- Excellent electrical properties
- Superior shielding effectiveness
- 25% shield overlap provides excellent shielding efficiency
- Good flexibility

Compliances:

- UL Style 2092 (UL: 60°C, 300V)
- UL Style 2093 (UL: 60°C, 300V)
- UL Style 2094 (UL: 60°C, 300V)
- UL Style 2106 (UL: 60°C, 600V)
- UL Style 2107 (UL: 60°C, 600V)
- UL Style 2464 (UL: 80°C, 300V)
- NEC Article 725 Type CL2 (UL: 75°C)
- NEC Article 800 Type CM (UL: 75°C)
- RoHS Compliant Directive 2002/95/EC
- Designed to meet UL 70,000 BTU Vertical Tray Flame Test
- CSA CMH (CSA: 60°C)
- Passes CSA CMH Flame Test

Packaging:

- Please contact Customer Service for packaging and color options

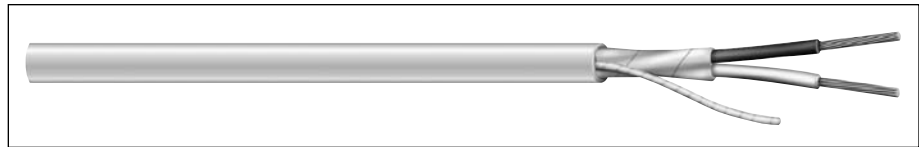

CATALOG NUMBER	NO. OF COND.	AWG SIZE	COND. STRAND	NOM. INSULATION THICKNESS		NOM. JACKET THICKNESS		NOMINAL O.D.		NOM. CAP***	
				INCHES	mm	INCHES	mm	INCHES	mm	A	B
UL STYLE 2092, CM (UL) C(UL) CMH, 300V											
C2513A	2	24	7/32	0.016	0.41	0.026	0.66	0.167	4.24	18.0	33.0
C2514A	2	22	7/30	0.016	0.41	0.020	0.51	0.167	4.24	20.0	36.0
C2524A	2	20	7/28	0.016	0.41	0.020	0.51	0.183	4.65	22.5	40.5
C2534A	2	18	16/30	0.016	0.41	0.020	0.51	0.201	5.21	25.5	45.5

Polyethylene Insulation, Color Code Chart #1

UL STYLE 2093, CM (UL) c(UL) CMH, 300V											
C2526A	3	22	7/30	0.016	0.41	0.030	0.76	0.196	4.98	18.5	33.5
C2528A	3	20	7/28	0.016	0.41	0.030	0.76	0.210	5.34	21.0	37.5
C2525A	3	20	7/28	0.016	0.41	0.030	0.76	0.213	5.41	21.0	37.0
C2535A	3	18	16/30	0.016	0.41	0.020	0.51	0.213	5.56	23.0	41.0

Polyethylene Insulation, Color Code Chart #1

UL STYLE 2094, CM (UL) c(UL) CMH, 300V											
C2523A	4	22	7/30	0.016	0.41	0.030	0.76	0.213	5.41	18.5	33.5
C2555A	4	20	7/28	0.016	0.41	0.030	0.76	0.234	5.94	20.5	36.5

Polyethylene Insulation, Color Code Chart #1

UL STYLE 2106, CSA, 600V											
C2536A*	2	16	19/.0117	0.031	0.79	0.032	0.81	0.307	7.80	20.0	36.0
C2538A**	2	14	19/.0147	0.031	0.79	0.032	0.81	0.335	8.51	23.0	42.0
C2539A**	2	12	19/.0185	0.032	0.81	0.032	0.81	0.376	9.55	26.0	46.0

* CM (UL) c(UL) CMH

** CL2

Polyethylene Insulation, Color Code Chart #1

UL STYLE 2107, CM (UL) c(UL) CMH, 600V											
C2537A	3	16	19/.0117	0.031	0.79	0.032	0.81	0.325	8.26	19.0	34.0

Polyethylene Insulation, Color Code Chart #1

UL STYLE 2464, CL2/CM (UL) c(UL) CMH, 300V											
C2540A	2	20	7/28	0.013	0.33	0.032	0.81	0.194	4.9	49.7	89.5

PVC Insulation, Color Code Chart #2

CM (UL) c(UL) CMH, 300V											
C2515A	2	22	Solid	0.007	0.18	0.020	0.51	0.124	3.15	30.0	55.0
C2516A	2	22	7/30	0.008	0.20	0.020	0.51	0.137	3.48	28.0	51.0
C2517A	3	22	7/30	0.008	0.20	0.020	0.51	0.144	3.36	25.0	45.0

Polypropylene Insulation, Color Code Chart #2

***A - Capacitance between conductors

***B - Capacitance between one conductor and other conductors connected to shield

Color Code Chart 1

NO. OF COND.	COLOR
1	Black
2	Natural
3	Red
4	Green

Color Code Chart 2

NO. OF COND.	COLOR
1	Black
2	Red
3	Clear

Multi-Conductor, Foil Shield

UL 2092, NEC Type CM (UL) c(UL) CMH

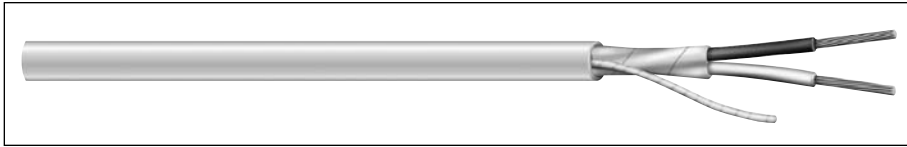

CATALOG NUMBER	NO. OF COND.	AWG SIZE	COND. STRAND	NOM. INSULATION THICKNESS		NOM. JACKET THICKNESS		NOMINAL O.D.		NOM. CAP.*	
				INCHES	mm	INCHES	mm	INCHES	mm	A	B
UL STYLE 2092, CM (UL) C(UL) CMH, 300V											
C2518A	2	22	7/30	0.016	0.41	0.026	0.66	0.181	4.60	20.0	36.0
C2519A	2	20	7/28	0.016	0.41	0.028	0.71	0.201	5.11	21.5	38.5
C2521A	2	18	16/30	0.018	0.46	0.028	0.71	0.229	5.82	23.5	43.0

Polyethylene Insulation, Color Code Chart #1

CM (UL) c(UL) CMH, 300V

C2520A	2	22	7/30	0.008	0.20	0.020	0.51	0.137	3.48	28.0	50.0
---------------	---	----	------	-------	------	-------	------	-------	------	------	------

Polypropylene Insulation, Color Code Chart #2

*A – Capacitance between conductors

*B – Capacitance between one conductor and other conductors connected to shield

Color Code Chart 1

NO. OF COND.	COLOR
1	Black
2	Natural

Color Code Chart 2

NO. OF COND.	COLOR
1	Black
2	Red

Product Construction:

Conductor:

- 22 thru 18 AWG fully annealed stranded tinned copper per ASTM B-33

Insulation:

- Premium-grade, color-coded polyethylene or polypropylene
- Color code: See charts below

Shield:

- 100% aluminum/polyester foil “bonded” to jacket, foil facing in
- Stranded tinned copper drain wire

Jacket:

- PVC, gray
- Temperature range: -20°C to +75°C

Applications:

- 100% shielded cable where RF shielding is required
- Control circuits
- Data and signal transmission
- Computer interconnections
- Suggested voltage rating: 300 volts

Features:

- The jacket and shield are “bonded” for ease of removal on automatic stripping equipment

Compliances:

- NEC Article 800 Type CM (UL: 75°C)
- UL Style 2092 (UL: 60°C, 300V)
- Designed to meet UL 70,000 BTU Vertical Tray Flame Test
- CSA CMH (CSA: 60°C)
- RoHS Compliant Directive 2002/95/EC
- Passes CSA CMH Flame Test

Packaging:

- Please contact Customer Service for packaging and color options



Multi-Conductor, Foil Shield

UL 2464, NEC Type CM (UL) c(UL), CSA CMG

Product Construction:

Conductor:

- 18 AWG fully annealed stranded tinned copper per ASTM B-33

Insulation:

- Premium-grade, color-coded S-R PVC
- Color code: See chart below

Shield:

- 100% Flexfoil® aluminum/polyester, 25% overlap, foil facing out
- Stranded tinned copper drain wire

Jacket:

- PVC, gray
- Temperature range: -20°C to +80°C

Applications:

- Audio, broadcast, instrumentation and sound systems
- Suggested voltage rating: 300 volts

Compliances:

- NEC Article 800 Type CM (UL: 75°C)
- UL Style 2464 (UL: 80°C, 300V)
- CSA CMG (60°C)
- RoHS Compliant Directive 2002/95/EC
- Designed to meet UL 70,000 BTU Vertical Tray Flame Test
- Passes CSA CMG Flame Test

Packaging:

- Please contact Customer Service for packaging and color options

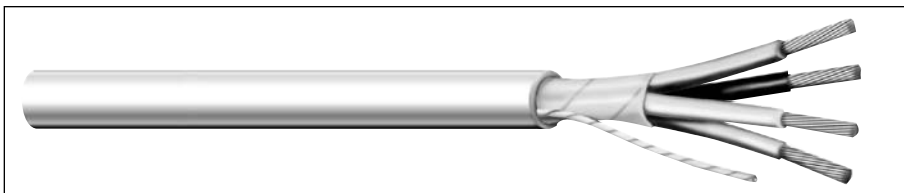

CATALOG NUMBER	NO. OF COND.	AWG SIZE	COND. STRAND	NOM. INSULATION THICKNESS		NOM. JACKET THICKNESS		NOMINAL O.D.		NOM. CAP.* pF/ft	
				INCHES	mm	INCHES	mm	INCHES	mm	A	B
C2543A	4	18	19/30	0.010	0.25	0.032	0.81	0.238	6.05	47	84.5

*A – Capacitance between conductors

*B – Capacitance between one conductor and other conductors connected to shield

Color Code Chart

NO. OF COND.	COLOR
1	Black
2	Red
3	White
4	Green

Multi-Conductor, Foil Shield

NEC Type CMP (UL) c(UL)



CATALOG NUMBER	NO. OF COND.	AWG SIZE	COND. STRAND	NOM. INSULATION THICKNESS		NOM. JACKET THICKNESS		NOMINAL O.D.		NOM. CAP.* pF/ft	
				INCHES	mm	INCHES	mm	INCHES	mm	A	B
C8106	3	18	19/30 TC	0.007	0.18	0.014	0.36	0.178	4.27	54.0	95.0
C8114	4	18	19/30 TC	0.007	0.18	0.014	0.36	0.185	4.70	30.0	55.0

*A – Capacitance between conductors

*B – Capacitance between one conductor and other conductors connected to shield

Color Code Chart

NO. OF COND.	COLOR
1	Black
2	White
3	Red
4	Green

Product Construction:

Conductor:

- 18 AWG fully annealed stranded tinned copper per ASTM B-33

Insulation:

- Premium-grade, color-coded FEP
- Color code: See chart below

Separator:

- Polyester tape with 25% overlap

Shield:

- 100% Flexfoil® aluminum/polyester foil with 25% overlap
- Stranded tinned copper drain wire

Jacket:

- FEP, red or as requested
- Temperature range: -40°C to +200°C

Applications:

- Computer systems
- Remote control circuits
- Process control and instrumentation
- Suggested voltage rating: 300 volts

Compliances:

- NEC Article 800
- Designed to meet NFPA 262 and CSA FT-6 Steiner Tunnel Fire Tests for Plenum Applications

Features:

- Fire-retardant, low-smoke jacket
- Suitable for outdoor and direct burial
- Chemical-resistant

Packaging:

- Please contact Customer Service for packaging and color options



Designed to Meet
NFPA 262 and CSA FT-6
Steiner Tunnel Fire Tests
for Plenum Applications

Underwriters Laboratories Inc.



Multi-Conductor, Foil Shield

NEC Type CMP (UL) c(UL) and/or CL2P

Product Construction:

Conductor:

- 22 thru 16 AWG fully annealed stranded tinned or bare copper per ASTM B-3, B-8 or B-33
- Class B stranding per ASTM B-8

Insulation:

- Premium-grade, color-coded Flexguard®
- Color code: See chart below

Shield:

- 100% Flexfoil® aluminum/polyester foil, with 25% overlap
- Stranded tinned copper drain wire

Jacket:

- Fluoropolymer, natural
- Temperature range: -20°C to +75°C
- Sequential footage marked to facilitate installations
- Stranded tinned copper drain wire
- Includes ripcord

Applications:

- Intercom systems
- Background music
- Audio systems
- Power-limited control circuits
- Suggested voltage rating: 150 volts

Compliances:

- NEC Article 725 (UL: 75°C, 150V)
- NEC Article 800 (UL: 75°C, 300V)
- Designed to meet NFPA 262 and CSA FT-6 Steiner Tunnel Fire Tests for Plenum Applications

Features:

- Abrasion-, chemical- and water-resistant jacket

Packaging:

- Please contact Customer Service for packaging and color options



CATALOG NUMBER	NO. OF COND.	AWG SIZE	COND. STRAND	NOM. INSULATION THICKNESS		NOM. JACKET THICKNESS		NOMINAL O.D.		NOM. CAP:**	
				INCHES	mm	INCHES	mm	INCHES	mm	A	B

22 AWG CONDUCTORS

C3154*	2	22	7/30 TC	0.006	0.15	0.010	0.25	0.103	2.62	51.0	92.0
C3310*	3	22	7/30 TC	0.006	0.15	0.010	0.25	0.116	2.95	45.0	81.0
C3155*	4	22	7/30 TC	0.006	0.15	0.010	0.25	0.130	3.30	45.0	81.0
C3311*	6	22	7/30 TC	0.006	0.15	0.010	0.25	0.152	3.86	40.0	73.0

20 AWG CONDUCTORS

C3320*	2	20	7/28 TC	0.007	0.18	0.010	0.25	0.120	3.05	53.0	96.0
C3321*	3	20	7/28 TC	0.007	0.18	0.010	0.25	0.136	3.45	46.0	84.0
C3322*	4	20	7/28 TC	0.007	0.18	0.010	0.25	0.153	3.89	46.0	84.0

18 AWG CONDUCTORS

C3162	2	18	7/26 BC	0.008	0.20	0.010	0.25	0.152	3.86	54.0	98.0
C3164	3	18	7/26 BC	0.008	0.20	0.010	0.25	0.158	4.01	47.0	85.0
C3163	4	18	7/26 BC	0.008	0.20	0.010	0.25	0.178	4.52	47.0	85.0
C3166	6	18	7/26 BC	0.008	0.20	0.010	0.25	0.212	5.38	43.0	76.0
C3180	8	18	7/26 BC	0.008	0.20	0.010	0.25	0.229	5.82	43.0	76.0
C3181	10	18	7/26 BC	0.008	0.20	0.010	0.25	0.273	6.93	43.0	76.0
C3182	12	18	7/26 BC	0.008	0.20	0.012	0.30	0.285	7.24	43.0	76.0

16 AWG CONDUCTORS

C3169	2	16	19/0.117 BC	0.008	0.20	0.010	0.25	0.181	4.60	62.0	112.0
C3340	3	16	7/0.0192 BC	0.008	0.20	0.010	0.25	0.185	4.70	52.0	93.0
C3341	4	16	7/0.0192 BC	0.008	0.20	0.010	0.25	0.210	5.16	52.0	93.0

*CL2P only

**A – Capacitance between conductors

**B – Capacitance between one conductor and other conductors connected to shield

Color Code Chart

NO. OF COND.	COLOR
1	Black
2	White
3	Red
4	Green
5	Brown
6	Blue
7	Orange
8	Yellow
9	Violet
10	Gray
11	Pink
12	Tan

Designed to Meet
NFPA 262 and CSA FT-6
Steiner Tunnel Fire Tests
for Plenum Applications

Underwriters Laboratories Inc.



Multi-Conductor, Foil Shield

NEC Type CMP (UL) c(UL) and CL3P

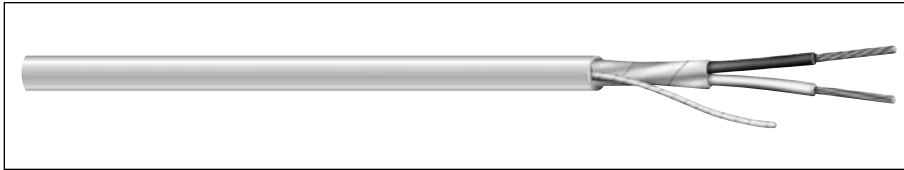

Product Construction:

Conductor:

- 22 thru 16 AWG fully annealed stranded tinned or bare copper per ASTM B-3, B-8 or B-33

Insulation:

- Premium-grade, color-coded Flexguard® PVC
- Color code: See chart below

Shield:

- 100% Flexfoil® aluminum/polyester foil with 25% overlap, minimum
- Stranded tinned copper drain wire

Jacket:

- Flexguard® PVC, natural
- Temperature range: 0°C to +75°C
- Sequential footage marked to facilitate installation
- Includes ripcord

Applications:

- Intercom systems
- Background music
- Audio systems
- Power-limited control circuits
- Suggested voltage rating: 150 volts

Compliances:

- NEC Article 725 (UL: 75°C, 150V)
- NEC Article 800 (UL: 75°C, 300V)
- Designed to meet NFPA 262 and CSA FT-6 Steiner Tunnel Fire Tests for Plenum Applications

Features:

- Flexible
- Easy to terminate

Packaging:

- Please contact Customer Service for packaging and color options

CATALOG NUMBER	NO. OF COND.	AWG SIZE	COND. STRAND	NOM. INSULATION THICKNESS		NOM. JACKET THICKNESS		NOMINAL O.D.		NOM. CAP.*	
				INCHES	mm	INCHES	mm	INCHES	mm	A	B
22 AWG CONDUCTORS											
C3158	2	22	7/30 TC	0.008	0.20	0.015	0.38	0.127	3.23	51.0	91.0
C3159	4	22	7/30 TC	0.008	0.20	0.015	0.38	0.146	3.71	45.0	81.0
18 AWG CONDUCTORS											
C3060	2	18	Solid BC	0.008	0.20	0.015	0.38	0.148	3.76	67.0	120.0
C3061	4	18	Solid BC	0.008	0.20	0.015	0.38	0.171	4.34	58.0	104.0
C3062	2	18	7/26 BC	0.008	0.20	0.015	0.38	0.164	4.17	61.0	110.0
C3064	3	18	7/26 BC	0.008	0.20	0.015	0.38	0.169	4.29	53.0	96.0
C3063	4	18	7/26 BC	0.008	0.20	0.015	0.38	0.185	4.70	53.0	96.0
C3065	6	18	7/26 BC	0.010	0.25	0.015	0.38	0.230	5.84	48.0	86.0
C3183	10	18	7/26 BC	0.012	0.20	0.015	0.38	0.310	7.87	47.0	84.0
C3184	12	18	7/26 BC	0.010	0.25	0.015	0.38	0.308	7.82	52.5	94.6
16 AWG CONDUCTORS											
C3068	2	16	19/.0117 BC	0.009	0.23	0.015	0.38	0.187	4.75	75.0	134.0

*A – Capacitance between conductors

*B – Capacitance between one conductor and other conductors connected to shield

Color Code Chart

NO. OF COND.	COLOR
1	Black
2	White
3	Red
4	Green
5	Brown
6	Blue
7	Orange
8	Yellow
9	Violet
10	Gray
11	Pink
12	Tan



Designed to Meet
NFPA 262 and CSA FT-6
Steiner Tunnel Fire Tests
for Plenum Applications

Underwriters Laboratories Inc.



Multi-Conductor, Foil Shield

Various AWM Styles, CSA Type AWM I/II A/B, NEC/CEC Type CMG (CSA C/US), NEC Type CL2

Product Construction:

Conductor:

- 24 thru 12 AWG fully annealed solid or stranded tinned copper per ASTM B-33

Insulation:

- Premium-grade, color-coded polypropylene
- Color code: See charts below

Shield:

- 100% Flexfoil® aluminum/polyester, 25% overlap, foil facing out
- Stranded tinned copper drain wire

Jacket:

- PVC, gray
- Temperature range: -20°C to +80°C

Applications:

- Recording studios and sound stages
- Broadcast and sound systems
- Computers
- Industrial equipment control
- Suggested voltage rating: 300 or 600 volts

Features:

- Excellent electrical properties
- Superior shielding effectiveness
- 25% shield overlap provides excellent shielding efficiency
- Good flexibility

Compliances:

- AWM Style 20251 (CSA: 60°C, 150V, 300V peak)
- CSA Type AWM (80°C, 600V)
- CSA Certified CMG to harmonized standard UL444 and CSA 22.2 No. 214
- NEC Type CL2/CEC Type CMG (CSA: 80°C, 300V)
- RoHS Compliant Directive 2002/95/EC
- Designed to meet CSA 70,000 BTU Vertical Tray Flame Test
- Passes CSA FT4 Vertical Flame Test

Packaging:

- Please contact Customer Service for packaging and color options

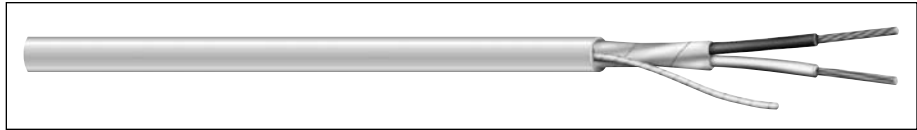

CATALOG NUMBER	NO. OF COND.	AWG SIZE	COND. STRAND	NOM. INSULATION THICKNESS		NOM. JACKET THICKNESS		NOMINAL O.D.		NOM. CAP.* pF/ft	
				INCHES	mm	INCHES	mm	INCHES	mm	A	B

AWM STYLE 20251, CSA TYPE AWM, CSA C/US TYPE CMG

C4152A	2	24	7/32	0.016	0.41	0.026	0.66	0.167	4.24	23.0	42.0
C4153A	2	22	7/30	0.016	0.41	0.026	0.66	0.179	4.55	21.0	38.0
C4154A	2	20	7/28	0.016	0.41	0.030	0.76	0.203	5.16	22.0	40.0
C4155A	2	18	16/30	0.018	0.46	0.030	0.76	0.233	5.92	24.0	43.0
C4156A	3	22	7/30	0.016	0.41	0.030	0.76	0.196	4.98	25.0	45.0
C4157A	3	20	7/28	0.016	0.41	0.030	0.76	0.210	5.33	27.0	51.0
C4158A	3	20	7/28	0.016	0.41	0.030	0.76	0.213	5.41	29.0	52.0
C4159A	3	18	16/30	0.018	0.46	0.030	0.76	0.247	6.27	22.0	40.0
C4160A	4	22	7/30	0.016	0.41	0.030	0.76	0.213	5.41	23.0	42.0
C4161A	4	20	7/28	0.016	0.41	0.030	0.76	0.234	5.94	26.0	74.0

Color Code Chart #1

AWM STYLE 2106, CSA TYPE AWM, CSA C/US TYPE CMG

C4162A	2	16	19/.0117	0.032	0.81	0.032	0.81	0.307	7.80	27.0	49.0
C4165A	3	16	19/.0117	0.032	0.81	0.032	0.81	0.326	8.28	26.0	46.0

Color Code Chart #1

NEC TYPE CL2, AWM STYLE 2464, CSA TYPE AWM

C4163A	2	14	41/30	0.020	0.51	0.032	0.81	0.298	7.57	31.0	56.0
---------------	---	----	-------	-------	------	-------	------	-------	------	------	------

Color Code Chart #3

NEC TYPE CL2, AWM STYLE 2106, CSA TYPE AWM

C4164A	2	12	19/.0185	0.032	0.81	0.040	1.02	0.390	9.90	35.0	63.0
---------------	---	----	----------	-------	------	-------	------	-------	------	------	------

Color Code Chart #1

AWM STYLE 20251, CSA TYPE AWM, CSA C/US TYPE CMG

C4167A	2	22	Solid	0.007	0.18	0.020	0.51	0.124	3.15	40.0	76.0
C4168A	2	22	7/30	0.008	0.20	0.020	0.51	0.137	3.48	34.0	67.0
C4169A	3	22	7/30	0.008	0.20	0.020	0.51	0.144	3.66	32.0	60.0

Polyethylene Insulation, Color Code Chart #2

*A – Capacitance between conductors

*B – Capacitance between one conductor and other conductors connected to shield

Color Code Chart 1

NO. OF COND.	COLOR
1	Black
2	Natural
3	Red
4	Green

Color Code Chart 2

NO. OF COND.	COLOR
1	Black
2	Red
3	Clear

Color Code Chart 3

NO. OF COND.	COLOR
1	Black
2	White

Multi-Conductor, Foil Shield

AWM Styles 2464, CSA Type AWM I/II A/B, NEC/CEC Type CMG (CSA C/US), or NEC Type CL2

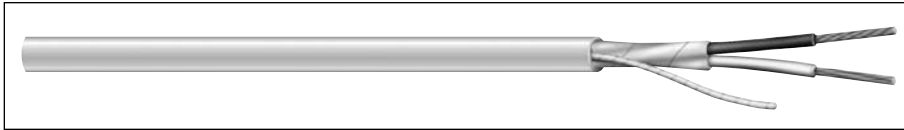

Product Construction:

Conductor:

- 22 thru 12 AWG fully annealed stranded tinned copper per ASTM B-33

Insulation:

- Premium-grade, color-coded PVC
- Color code: See charts below

Shield:

- 100% Flexfoil® aluminum/polyester, 25% overlap, foil facing out
- Stranded tinned copper drain wire

Jacket:

- PVC, gray
- Temperature range: -20°C to +105°C

Applications:

- Recording studios and sound stages
- Broadcast and sound systems
- Industrial equipment control
- Suitable for EIA RS-232 applications
- Suggested voltage rating: 300 or 600 volts

Features:

- Superior shielding effectiveness
- 25% shield overlap provides excellent shielding efficiency
- Good flexibility

Compliances:

- AWM Style 2464 (UL or CSA: 80°C, 300V)
- CSA Type AWM (105°C, 600V)
- CSA Certified CMG to harmonized standard UL444 and CSA 22.2 No. 214
- NEC/CEC Type CMG (CSA: 105°C, 300V)
- RoHS Compliant Directive 2002/95/EC
- Designed to meet CSA 70,000 BTU Vertical Tray Flame Test
- Passes CSA FT4 Vertical Flame Test
- UL Certified CL2 to Standard UL 13*

Packaging:

- Please contact Customer Service for packaging and color options

CATALOG NUMBER	NO. OF COND.	AWG SIZE	COND. STRAND	NOM. INSULATION THICKNESS		NOM. JACKET THICKNESS		NOMINAL O.D.		COLOR CODE	NOM. CAP.* pF/ft	
				INCHES	mm	INCHES	mm	INCHES	mm		A	B

AWM STYLE 2464, CSA TYPE AWM, CSA C/US TYPE CMG

C4192A	2	22	7/30	0.009	0.23	0.030	0.76	0.165	4.19	1	47.0	85.0
C4210A	2	22	7/30	0.009	0.23	0.032	0.81	0.165	4.19	2	47.0	85.0
C4193A	3	22	7/30	0.009	0.23	0.030	0.76	0.169	4.29	2	43.0	76.0
C4194A	4	22	7/30	0.009	0.23	0.030	0.76	0.181	4.60	2	43.0	76.0
C4207A	6	22	7/30	0.009	0.23	0.032	0.81	0.204	5.18	2	43.0	76.0
C4208A	8	22	7/30	0.009	0.23	0.032	0.81	0.223	5.66	2	43.0	76.0
C4166A	2	20	7/28	0.012	0.30	0.030	0.76	0.187	4.75	1	46.0	83.0
C4211A	2	20	7/28	0.012	0.30	0.032	0.81	0.191	4.85	2	46.0	83.0
C4195A	3	20	7/28	0.012	0.30	0.030	0.76	0.200	5.08	2	42.0	75.0
C4196A	4	20	7/28	0.012	0.30	0.030	0.76	0.216	5.49	2	42.0	75.0
C4197A	2	18	16/30	0.012	0.30	0.030	0.76	0.203	5.16	1	51.0	92.0
C4212A	2	18	16/30	0.012	0.30	0.032	0.81	0.205	5.20	2	51.0	92.0
C4198A	3	18	16/30	0.012	0.30	0.030	0.76	0.214	5.44	2	46.0	83.0
C4204A	4	18	16/30	0.012	0.30	0.032	0.81	0.236	5.99	2	46.0	83.0
C4205A	6	18	16/30	0.012	0.30	0.032	0.81	0.271	6.88	2	46.0	83.0
C4199A	2	16	19/.0117	0.010	0.25	0.030	0.76	0.218	5.54	1	62.0	112.0
C4213A	2	16	19/.0117	0.010	0.25	0.032	0.81	0.219	5.56	2	62.0	112.0
C4200A	3	16	19/.0117	0.010	0.25	0.030	0.76	0.230	5.84	2	58.0	104.0

AWM STYLE 2464, CSA TYPE AWM (FT4), NEC TYPE CL2*

C4201A	2	14	19/.0147	0.014	0.36	0.030	0.76	0.268	6.81	1	60.0	107.0
C4215A	2	14	19/.0147	0.014	0.36	0.030	0.76	0.268	6.81	2	60.0	107.0
C4202A	2	12	19/.0185	0.014	0.36	0.030	0.76	0.302	7.67	1	64.0	116.0

*A – Capacitance between conductors

*B – Capacitance between one conductor and other conductors connected to shield

Color Code Chart 1

NO. OF COND.	COLOR
1	Black
2	Red

Color Code Chart 2

NO. OF COND.	COLOR
1	Black
2	White
3	Red
4	Green
5	Brown
6	Blue
7	Orange
8	Yellow



Multi-Conductor, Foil Shield

AWM Style 2464, CSA Type AWM I/II A/B, NEC/CEC Type CMG (CSA C/US)

Product Construction:

Conductor:

- 24 AWG fully annealed stranded tinned copper per ASTM B-33

Insulation:

- Premium-grade, color-coded PVC
- Color code: See charts below

Shield:

- 100% Flexfoil® aluminum/polyester with 25% overlap, foil facing out
- Stranded tinned copper drain wire

Jacket:

- PVC, gray
- Temperature range: -20°C to +105°C

Applications:

- Computer interconnections
- Data transmission
- Control circuits
- Industrial equipment control
- Suitable for EIA RS-232 applications
- Suggested voltage rating: 300 or 600 volts

Features:

- Superior shielding effectiveness
- 25% shield overlap provides excellent shielding efficiency
- Good flexibility

Compliances:

- AWM Style 2464 (UL or CSA: 80°C, 300V)
- CSA Type AWM (105°C, 600V)
- CSA Certified CMG to harmonized standard UL444 and CSA 22.2 No. 214
- NEC/CEC Type CMG (CSA: 105°C, 300V)
- RoHS Compliant Directive 2002/95/EC
- Designed to meet CSA 70,000 BTU Vertical Tray Flame Test
- Passes CSA FT4 Vertical Flame Test

Packaging:

- Please contact Customer Service for packaging and color options

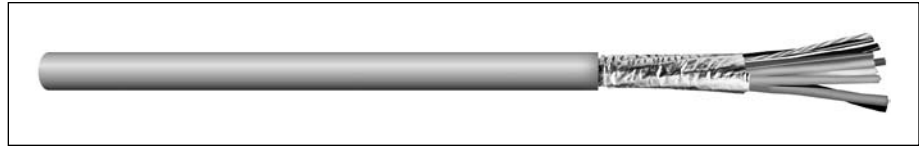

CATALOG NUMBER	NO. OF COND.	AWG SIZE	COND. STRAND	NOMINAL INSULATION THICKNESS		NOMINAL JACKET THICKNESS		NOMINAL O.D.		NOMINAL DCR Ω/kft @20°C		NOMINAL CAP* pF/ft	
				INCHES	mm	INCHES	mm	INCHES	mm	COND.	SHLD.	A	B
AWM STYLE 2464, CSA TYPE AWM, CSA C/US TYPE CMG													
C4216A	2	24	7/32	0.010	0.25	0.032	0.81	0.157	3.99	26.0	18.0	40.0	72.0
C4217A	3	24	7/32	0.010	0.25	0.032	0.81	0.164	4.17	26.0	18.0	36.0	66.0
C4218A	4	24	7/32	0.010	0.25	0.032	0.81	0.175	4.45	26.0	18.0	36.0	66.0
C4219A	5	24	7/32	0.010	0.25	0.032	0.81	0.188	4.78	26.0	16.0	36.0	66.0
C4220A	6	24	7/32	0.010	0.25	0.032	0.81	0.201	5.11	26.0	16.0	34.0	61.0
C4221A	7	24	7/32	0.010	0.25	0.032	0.81	0.201	5.11	26.0	16.0	34.0	61.0
C4222A	8	24	7/32	0.010	0.25	0.032	0.81	0.215	5.46	26.0	16.0	34.0	61.0
C4223A	9	24	7/32	0.010	0.25	0.032	0.81	0.228	5.79	26.0	16.0	34.0	61.0
C4224A	10	24	7/32	0.010	0.25	0.032	0.81	0.245	6.22	26.0	14.0	34.0	61.0

Color Code Chart #1

C4225A	15	24	7/32	0.010	0.25	0.032	0.81	0.276	7.01	26.0	14.0	34.0	61.0
C4226A	20	24	7/32	0.010	0.25	0.032	0.81	0.303	7.70	26.0	14.0	34.0	61.0
C4227A	25	24	7/32	0.010	0.25	0.032	0.81	0.333	8.46	26.0	12.0	34.0	61.0
C4228A	30	24	7/32	0.010	0.25	0.032	0.81	0.351	8.92	26.0	12.0	34.0	61.0
C4229A	40	24	7/32	0.010	0.25	0.032	0.81	0.391	9.93	26.0	12.0	34.0	61.0
C4230A	50	24	7/32	0.010	0.25	0.032	0.81	0.439	11.15	26.0	10.0	34.0	61.0

Color Code Chart #2

*A – Capacitance between conductors

*B – Capacitance between one conductor and other conductors connected to shield

Color Code Chart 1 – For cables up to and including 10 conductors

NO. OF COND.	COLOR	NO. OF COND.	COLOR
1	Black	6	Blue
2	White	7	Orange
3	Red	8	Yellow
4	Green	9	Violet
5	Brown	10	Gray

Color Code Chart 2 Per ICEA – For cables of 15 to 50 conductors

NO. OF COND.	COLOR	NO. OF COND.	COLOR	NO. OF COND.	COLOR
1	Black	18	Orange/Red	35	White/Red/Orange
2	White	19	Blue/Red	36	Orange/White/Blue
3	Red	20	Red/Green	37	White/Red/Blue
4	Green	21	Orange/Green	38	Black/White/Green
5	Orange	22	Black/White/Red	39	White/Black/Green
6	Blue	23	White/Black/Red	40	Red/White/Green
7	White/Black	24	Red/Black/White	41	Green/White/Blue
8	Red/Black	25	Green/Black/White	42	Orange/Red/Green
9	Green/Black	26	Orange/Black/White	43	Blue/Red/Green
10	Orange/Black	27	Blue/Black/White	44	Black/White/Blue
11	Blue/Black	28	Black/Red/Green	45	White/Black/Blue
12	Black/White	29	White/Red/Green	46	Red/White/Blue
13	Red/White	30	Red/Black/Green	47	Green/Orange/Red
14	Green/White	31	Green/Black/Orange	48	Orange/Red/Blue
15	Blue/White	32	Orange/Black/Green	49	Blue/Red/Orange
16	Black/Red	33	Blue/White/Orange	50	Black/Orange/Red
17	White/Red	34	Black/White/Orange		

Power-Limited Tray Cable, Foil Shield

NEC Type PLTC

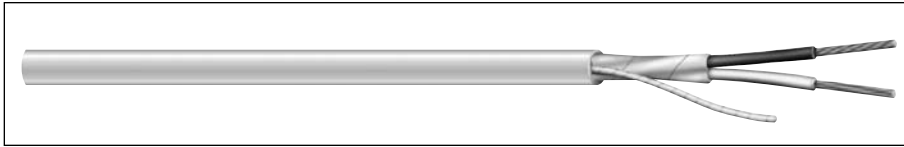

CATALOG NUMBER	NO. OF COND.	AWG SIZE	COND. STRAND	NOM. INSULATION THICKNESS		NOM. JACKET THICKNESS		NOMINAL O.D.		NOM. CAP.*	
				INCHES	mm	INCHES	mm	INCHES	mm	A	B
C0450A	2	22	7/30	0.013	0.33	0.037	0.94	0.191	4.85	43.0	77.5
C0451A	3	22	7/30	0.013	0.33	0.037	0.94	0.199	5.05	39.5	71.0
C0452A	2	20	7/28	0.013	0.33	0.037	0.94	0.207	5.26	50.0	89.5
C0453A	3	20	7/28	0.013	0.33	0.037	0.94	0.217	5.51	45.0	81.0
C0454A	2	18	16/30	0.015	0.38	0.037	0.94	0.227	5.77	51.5	92.5
C0455A	3	18	16/30	0.015	0.38	0.037	0.94	0.238	6.04	46.5	83.5
C0456A	2	16	19/.0117	0.013	0.33	0.037	0.94	0.243	6.17	64.0	115.5
C0457A	3	16	19/.0117	0.013	0.33	0.037	0.94	0.255	6.48	56.5	102.0
C0458A	2	14	19/.0147	0.013	0.33	0.042	1.07	0.288	7.32	72.5	131.0
C0459A	3	14	19/.0147	0.015	0.33	0.042	1.07	0.298	7.57	60.0	108.0
C0460A	2	12	19/.0185	0.013	0.33	0.042	1.07	0.315	8.00	80.5	145.0

*A – Capacitance between conductors

*B – Capacitance between one conductor and other conductors connected to shield

Color Code Chart

NO. OF COND.	COLOR
1	Black
2	Red
3	White

Product Construction:

Conductor:

- 22 thru 12 AWG fully annealed stranded tinned copper per ASTM B-33

Insulation:

- Premium-grade, color-coded PVC
- Color code: See chart below

Shield:

- 100% Flexfoil® aluminum/polyester, 25% overlap foil facing out
- Stranded tinned copper drain wire

Jacket:

- PVC, gray
- Temperature range: -20°C to +105°C

Applications:

- Cable tray installations
- Power limited circuits
- Intercom systems
- Business machines
- Cash registers
- Industrial control systems
- Petrochemical refineries
- Suggested voltage rating: 300 volts
- Burglar alarms

Features:

- Sunlight-resistant PVC jacket
- Good weather resistance
- UL tray cable rated

Compliances:

- NEC Article 725 Power-Limited Tray Cable (UL: 105°C, 300V)
- RoHS Compliant Directive 2002/95/EC
- Designed to meet UL 70,000 BTU Vertical Tray Flame Test

Packaging:

- Please contact Customer Service for packaging and color options

Multi-Conductor, Spiral Shield

UL 2095, NEC Type CL2 and CM (UL) c(UL), CSA CMG

Product Construction:

Conductor:

- 22 thru 16 AWG fully annealed stranded tinned copper per ASTM B-33

Insulation:

- Premium-grade, color-coded PVC
- Color code: See charts below

Shield:

- 85% spiral tinned copper

Jacket:

- PVC, gray
- Temperature range: -20°C to +80°C

Applications:

- Electronic circuits where RF shielding is required
- Radio transmitters
- Sound systems
- Recording studios
- Suggested voltage rating: 300 volts

Features:

- Spiral shield allows ease of “pigtail soldering”
- Maximum flexibility

Compliances:

- NEC Article 800 Type CM (UL: 75°C)
- UL Style 2095 (UL: 80°C, 300V)
- CSA CMG (CSA: 60°C)
- RoHS Compliant Directive 2002/95/EC
- Designed to meet UL 70,000 BTU Vertical Tray Flame Test
- Passes CSA CMG Flame Test
- NEC Article 725 Type CL2 (UL: 75°C)

Packaging:

- Please contact Customer Service for packaging and color options

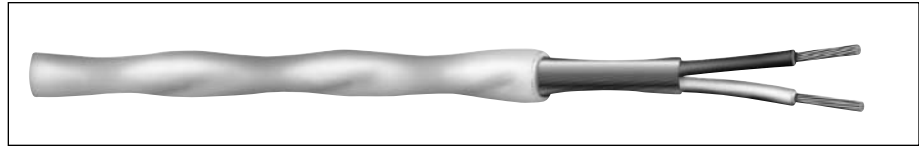

CATALOG NUMBER	NO. OF COND.	AWG SIZE	COND. STRAND	NOM. INSULATION THICKNESS		NOM. JACKET THICKNESS		NOMINAL O.D.		NOM. CAP.* pF/ft	
				INCHES	mm	INCHES	mm	INCHES	mm	A	B

UL STYLE 2095, CM (UL) c(UL), CSA CMG, 300V

C2882A	2	22	7/30	0.015	0.38	0.032	0.81	0.197	5.00	40.0	72.0
C2888A	2	20	7/28	0.016	0.41	0.032	0.81	0.215	5.46	44.0	80.2

Color Code Chart #1

CL2/CM (UL) c(UL), CSA CMG, 300V

C1335A	3	22	7/30	0.015	0.38	0.032	0.81	0.206	5.23	37.0	67.0
C1337A	4	22	7/30	0.015	0.38	0.032	0.81	0.222	5.64	37.0	67.0
C1341A	6	22	7/30	0.015	0.38	0.032	0.81	0.257	6.53	34.5	62.0
C2768A	3	18	7/26	0.020	0.51	0.032	0.81	0.266	6.76	41.0	74.0

Color Code Chart #1

CM (UL) c(UL), CSA CMG, 300V

C2892A	2	18	16/30	0.016	0.41	0.032	0.81	0.252	6.40	49.5	89.0
C2895A	2	16	19/.0117	0.016	0.41	0.032	0.81	0.265	6.73	58.0	104.0

Color Code Chart #2

*A – Capacitance between conductors

*B – Capacitance between one conductor and other conductors connected to shield

Color Code Chart 1

NO. OF COND.	COLOR
1	Black
2	Red
3	White
4	Green
5	Yellow
6	Blue

Color Code Chart 2

CATALOG NUMBER	CONDUCTOR	COLOR
C2892A	1	White
	2	Red
C2895A	1	White
	2	Black

Multi-Conductor, Braid Shield

NEC Type CL2 and CM(UL) c(UL), CSA CMG

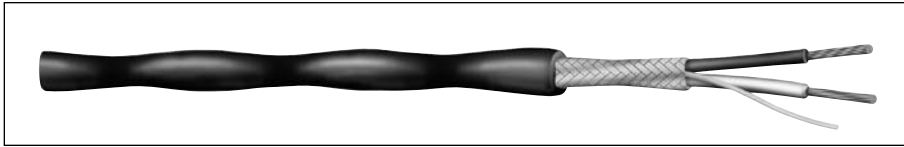

CATALOG NUMBER	NO. OF COND.	AWG SIZE	COND. STRAND	NOM. INSULATION THICKNESS		NOM. JACKET THICKNESS		NOMINAL O.D.		NOM. CAP.*	
				INCHES	mm	INCHES	mm	INCHES	mm	A	B
C2676A	2	22	Solid	0.015	0.38	0.032	0.81	0.209	5.31	38.6	69.4
C2677A	2	22	7/30	0.015	0.38	0.032	0.81	0.211	5.36	39.3	70.7

A – Capacitance between conductors

*B – Capacitance between one conductor and other conductors connected to shield

Color Code Chart

NO. OF COND.	COLOR
1	Black
2	Red

Product Construction:

Conductor:

- 22 AWG fully annealed solid or stranded tinned copper per ASTM B-33

Insulation:

- Premium-grade, color-coded PVC
- Color code: See chart below

Shield:

- 88% tinned copper braid
- Stranded or solid tinned copper drain wire

Jacket:

- PVC, black
- Temperature range: -20°C to +75°C

Applications:

- Electronic circuits where RF shielding is required
- Radio transmitters
- Sound systems
- Recording studios
- Good flexibility
- Excellent shielding for noise reduction
- Suggested voltage rating: 300 volts

Compliances:

- NEC Article 800 Type CM (UL: 75°C)
- RoHS Compliant Directive 2002/95/EC
- Designed to meet UL 70,000 BTU Vertical Tray Flame Test
- NEC Article 725 Type CL2 (UL: 75°C)

Packaging:

- Please contact Customer Service for packaging and color options



Multi-Conductor, Braid Shield

UL 2092, 2093, 2094, NEC Type CM (UL) c(UL) CMH

Product Construction:

Conductor:

- 20 AWG fully annealed stranded tinned copper per ASTM B-33

Insulation:

- Premium-grade, color-coded polyethylene
- Color code: See chart below

Shield:

- 80% tinned copper braid
- Mylar wrap under braid

Jacket:

- PVC, gray
- Temperature range: -20°C to +75°C

Applications:

- Electronic circuits where RF shielding is required
- Video interconnect
- Broadcast and studio
- Sound systems
- Suggested voltage rating: 300 volts

Features:

- Low capacitance
- Lightweight
- Excellent shielding for noise reduction

Compliances:

- NEC Article 800 Type CM/CMH (UL: 75°C)
- AWM style 2092 (UL: 60°C, 300V)
- AWM style 2093 (UL: 60°C, 300V)
- AWM style 2094 (UL: 60°C, 300V)
- RoHS Compliant Directive 2002/95/EC
- Designed to meet UL VW-1 Vertical Wire Flame Test

Packaging:

- Please contact Customer Service for packaging and color options

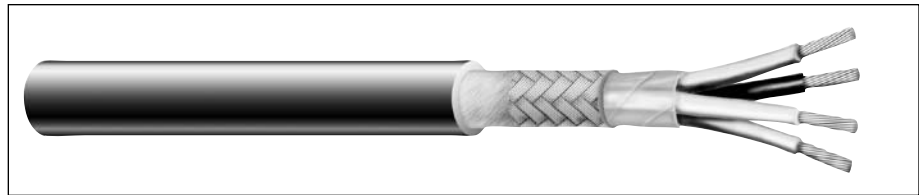

CATALOG NUMBER	NO. OF COND.	AWG SIZE	COND. STRAND	NOM. INSULATION THICKNESS		NOM. JACKET THICKNESS		NOMINAL O.D.		NOM. CAP.* pF/ft	
				INCHES	mm	INCHES	mm	INCHES	mm	A	B

AWM STYLE 2092, CM (UL) c(UL) CMH, 300V

C1642A	2	20	26/34	0.016	0.38	0.029	0.74	0.226	5.74	24.0	43.0
---------------	---	----	-------	-------	------	-------	------	-------	------	------	------

AWM STYLE 2093, CM (UL) c(UL) CMH, 300V

C1643A	3	20	26/34	0.016	0.38	0.029	0.74	0.236	5.99	22.0	40.0
---------------	---	----	-------	-------	------	-------	------	-------	------	------	------

AWM STYLE 2094, CM (UL) c(UL) CMH 300V

C1644A	4	20	26/34	0.016	0.38	0.029	0.74	0.255	6.48	22.0	39.0
C1645A	5	20	26/34	0.016	0.38	0.029	0.74	0.274	6.96	22.0	39.0
C1646A	6	20	26/34	0.016	0.38	0.029	0.74	0.290	7.37	20.0	36.0

*A – Capacitance between conductors

*B – Capacitance between one conductor and other conductors connected to shield

Color Code Chart

NO. OF COND.	COLOR
1	Black
2	White
3	Red
4	Green
5	Yellow
6	Blue

Multi-Conductor, Braid Shield

UL 2095, NEC Type CM (UL) c(UL)

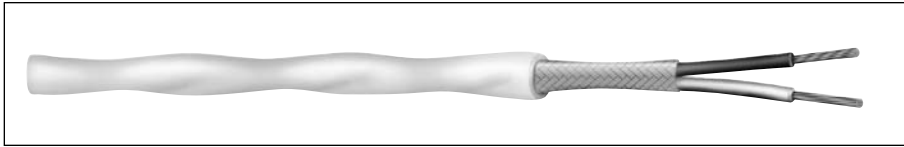

CATALOG NUMBER	NO. OF COND.	AWG SIZE	COND. STRAND	NOM. INSULATION THICKNESS		NOM. JACKET THICKNESS		NOMINAL O.D.		NOM. CAP.*	
				INCHES	mm	INCHES	mm	INCHES	mm	A	B
C2679A	2	22	7/30	0.015	0.38	0.032	0.81	0.212	5.38	40.0	72.0
C2678A	3	22	7/30	0.015	0.38	0.032	0.81	0.221	5.61	37.0	67.0
C2680A	4	22	7/30	0.015	0.38	0.032	0.81	0.237	6.02	37.0	67.0
C2681A	2	20	7/28	0.016	0.41	0.032	0.81	0.230	5.84	44.0	80.0
C1332A	3	20	7/28	0.016	0.41	0.032	0.81	0.240	6.10	40.0	72.0
C2683A	4	20	7/28	0.016	0.41	0.032	0.81	0.259	6.58	40.0	73.0
C2686A	2	18	16/30	0.016	0.41	0.032	0.81	0.252	6.40	49.0	89.0
C2687A	3	18	16/30	0.016	0.41	0.032	0.81	0.264	6.71	45.0	80.5
C2688A	4	18	16/30	0.016	0.41	0.032	0.81	0.286	7.26	45.0	80.5
C2689A	2	16	19/29	0.020	0.51	0.030	0.76	0.280	7.11	51.0	91.0

*A – Capacitance between conductors

*B – Capacitance between one conductor and other conductors connected to shield

Color Code Chart

NO. OF COND.	COLOR
1	Black
2	Red
3	White
4	Green

Product Construction:

Conductor:

- 22 thru 16 AWG fully annealed stranded tinned copper per ASTM B-33

Insulation:

- Premium-grade, color-coded PVC
- Color code: See chart below

Shield:

- 75% tinned copper braid

Jacket:

- PVC, gray
- Temperature range: -20°C to +80°C

Applications:

- Electronic circuits where RF shielding is required
- Radio transmitters
- Sound systems
- Recording studios
- Provides good flexibility
- Excellent shielding for noise reduction
- Suggested voltage rating: 300 volts

Compliances:

- NEC Article 800 Type CM (UL: 75°C)
- UL Style 2095 (UL: 80°C, 300V)
- RoHS Compliant Directive 2002/95/EC
- Designed to meet UL 70,000 BTU Vertical Tray Flame Test
- CSA CMG (CSA: 60°C)
- Passes CSA CMG Flame Test

Packaging:

- Please contact Customer Service for packaging and color options



Multi-Conductor, Braid Shield

MIL-W-16878 Type B

Product Construction:

Conductor:

- 28 AWG fully annealed stranded tinned copper per ASTM B-33

Insulation:

- Premium-grade, color-coded PVC per MIL-W-16878 Type B
- Color code: See chart below

Shield:

- 90% tinned copper braid

Jacket:

- PVC, gray
- Temperature range: -20°C to +90°C

Applications:

- Electronic circuits where RF shielding is required
- Remote control for studio equipment
- Sound systems
- Provides good flexibility
- Excellent shielding for noise reduction
- Suggested voltage rating: 600 volts
- Non QPL

Compliances:

- RoHS Compliant Directive 2002/95/EC

Packaging:

- Please contact Customer Service for packaging and color options

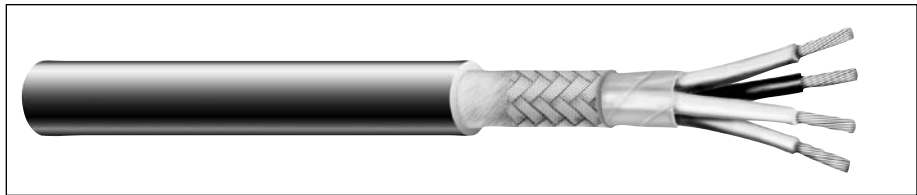

CATALOG NUMBER	NO. OF COND.	AWG SIZE	COND. STRAND	NOM. INSULATION THICKNESS		NOM. JACKET THICKNESS		NOMINAL O.D.		NOM. CAP.* pF/ft	
				INCHES	mm	INCHES	mm	INCHES	mm	A	B
C6500A	2	28	7/36	0.010	0.28	0.016	0.41	0.130	3.30	34.0	61.0
C6501A	3	28	7/36	0.010	0.28	0.016	0.41	0.135	3.30	32.5	58.5
C6502A	4	28	7/36	0.010	0.28	0.016	0.41	0.145	3.68	32.5	58.5
C6503A	6	28	7/36	0.010	0.28	0.019	0.48	0.172	4.37	30.5	55.0
C6504A	8	28	7/36	0.010	0.28	0.021	0.53	0.187	4.75	30.5	55.0
C6505A	10	28	7/36	0.010	0.28	0.021	0.53	0.212	5.38	30.5	55.0
C6506A	12	28	7/36	0.010	0.28	0.021	0.53	0.217	5.51	30.5	55.0
C6507A	15	28	7/36	0.010	0.28	0.021	0.53	0.237	6.01	30.5	55.0
C6508A	20	28	7/36	0.010	0.28	0.021	0.53	0.259	6.58	30.5	55.0

*A – Capacitance between conductors

*B – Capacitance between one conductor and other conductors connected to shield

Color Code Chart

NO. OF COND.	COLOR	NO. OF COND.	COLOR	NO. OF COND.	COLOR
1	Black	8	Red/Black	15	Blue/White
2	White	9	Green/Black	16	Black/Red
3	Red	10	Orange/Black	17	White/Red
4	Green	11	Blue/Black	18	Orange/Red
5	Orange	12	Black/White	19	Blue/Red
6	Blue	13	Red/White	20	Red/Green
7	White/Black	14	Green/White		

Multi-Conductor, Foil/Braid Shield

UL 2094, NEC Type CL2

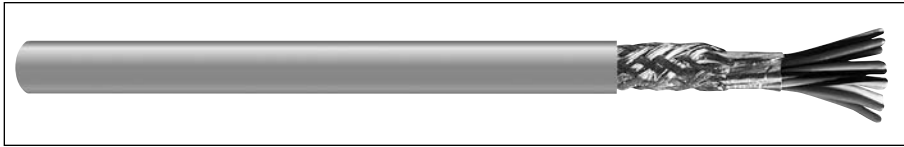

CATALOG NUMBER	NO. OF COND.	AWG SIZE	COND. STRAND	NOM. INSULATION THICKNESS		NOM. JACKET THICKNESS		NOMINAL O.D.		NOM. CAP.*	
				INCHES	mm	INCHES	mm	INCHES	mm	A	B
C1648A	8	20	26/34	0.016	0.38	0.029	0.74	0.316	8.03	20.0	36.0

*A – Capacitance between conductors

*B – Capacitance between one conductor and other conductors connected to shield

Color Code Chart

NO. OF COND.	COLOR	NO. OF COND.	COLOR
1	Black	5	Yellow
2	White	6	Blue
3	Red	7	Brown
4	Green	8	Orange

Product Construction:

Conductor:

- 20 AWG fully annealed stranded tinned copper per ASTM B-33

Insulation:

- Premium-grade, color-coded polyethylene
- Color code: See chart below

Shield:

- 100% Flexfoil® aluminum/polyester, 25% overlap, foil facing out
- 80% tinned copper braid

Jacket:

- PVC, gray
- Temperature range: -20°C to +75°C

Applications:

- Electronic circuits where RF shielding is required
- Video interconnect
- Broadcast and studio
- Sound systems
- Suggested voltage rating: 300 volts

Features:

- Low capacitance
- Lightweight
- Excellent shielding for noise reduction

Compliances:

- NEC Article 725 Type CL2 (UL: 75°C)
- UL Style 2094 (UL: 60°C, 300V)
- RoHS Compliant Directive 2002/95/EC
- Designed to meet UL 70,000 BTU Vertical Tray Flame Test

Packaging:

- Please contact Customer Service for packaging and color options



Designed to Meet
UL Vertical Tray
Flame Test

Underwriters Laboratories Inc.



Multi-Conductor, Foil & TC Braid Shield

NEC Type CMP (UL) c(UL)

Product Construction:

Conductor:

- Fully annealed stranded tinned copper per ASTM B-33

Insulation:

- Premium-grade, color-coded FEP
- Color code: See chart below

Separator:

- Polyester tape with 25% overlap

Shield:

- 100% Flexfoil® aluminum/polyester foil with 25% overlap
- Tinned copper braid, 90% coverage

Jacket:

- FEP, red or as requested
- Temperature range: -40°C to +200°C

Applications:

- Computer systems
- Remote control circuits
- Process control and instrumentation
- Audio controls
- Suggested voltage rating: 300 volts

Compliances:

- NEC Article 800
- Designed to meet NFPA 262 and CSA FT-6 Steiner Tunnel Fire Tests for Plenum Applications

Features:

- Fire-retardant, low-smoke jacket

Packaging:

- Please contact Customer Service for packaging and color options



CATALOG NUMBER	NO. OF COND.	AWG SIZE	COND. STRAND	NOM. INSULATION THICKNESS		NOM. JACKET THICKNESS		NOMINAL O.D.		NOM. CAP* pF/ft	
				INCHES	mm	INCHES	mm	INCHES	mm	A	B

16 AWG CONDUCTORS

C8108	6	16	19/29	0.007	0.18	0.014	0.36	0.270	6.86	33.0	61.0
C8119	3	16	19/29	0.007	0.18	0.014	0.36	0.209	5.31	35.0	63.0
C8111	2	16	19/29	0.007	0.18	0.014	0.36	0.198	5.03	35.0	63.0

18 AWG CONDUCTORS

C8120	6	18	19/30	0.007	0.18	0.014	0.36	0.242	6.15	33.0	61.0
C8110	4	18	19/30	0.007	0.18	0.014	0.36	0.206	5.23	35.0	63.0
C8107	3	18	19/30	0.007	0.18	0.014	0.36	0.190	4.83	35.0	63.0

24 AWG CONDUCTORS

C8115	3	24	7/32	0.006	0.15	0.014	0.36	0.133	3.38	25.0	45.0
--------------	---	----	------	-------	------	-------	------	-------	------	------	------

*A – Capacitance between conductors

*B – Capacitance between one conductor and other conductors connected to shield

Color Code Chart

NO. OF COND.	COLOR
1	Black
2	White
3	Red
4	Green
5	Orange
6	Blue

Multi-Conductor, Rubber, Braid Shield

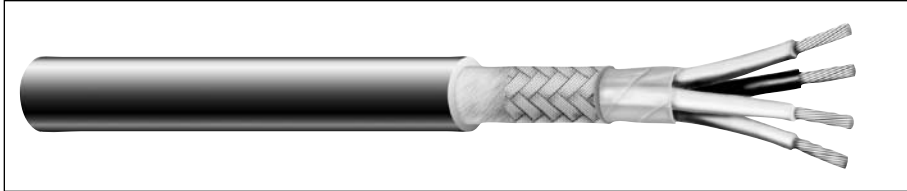

CATALOG NUMBER	NO. OF COND.	AWG SIZE	COND. STRAND	NOM. INSULATION THICKNESS		NOM. JACKET THICKNESS		NOMINAL O.D.	
				INCHES	mm	INCHES	mm	INCHES	mm
C1302	2	20	26/34	0.020	0.51	0.035	0.89	0.270	6.86
C1304	3	20	26/34	0.020	0.51	0.035	0.89	0.285	7.24
C1305	4	20	26/34	0.020	0.51	0.035	0.89	0.300	7.62
C1308	5	20	26/34	0.020	0.51	0.035	0.89	0.330	8.38
C1310	6	20	26/34	0.020	0.51	0.035	0.89	0.340	8.64
C1312	7	20	26/34	0.020	0.51	0.035	0.89	0.355	9.02
C1313	8	20	26/34	0.020	0.51	0.035	0.89	0.385	9.78

Color Code Chart

NO. OF COND.	COLOR	NO. OF COND.	COLOR
1	Black	5	Blue
2	White	6	Brown
3	Red	7	Yellow
4	Green	8	Orange

Product Construction:

Conductor:

- 20 AWG fully annealed stranded tinned copper per ASTM B-33

Insulation:

- Premium-grade, color-coded rubber
- Color code: See chart below

Shield:

- 80% tinned copper braid

Jacket:

- Rubber, black
- Temperature range: -20°C to +60°C

Applications:

- Control circuits
- Broadcast and studio applications
- Audio interconnects
- Suggested voltage rating: 300 volts

Features:

- Impact- and abrasion-resistant
- Stranded conductors for superior flexibility

Compliances:

- RoHS Compliant Directive 2002/95/EC

Packaging:

- Please contact Customer Service for packaging and color options

Multi-Conductor, Carolprene[®], Braid Shield

Product Construction:

Conductor:

- 18 thru 14 AWG fully annealed stranded tinned copper per ASTM B-33

Insulation:

- Premium-grade, color-coded rubber
- Color code: See chart below

Shield:

- 80% tinned copper braid

Jacket:

- Carolprene[®], black
- Temperature range: -20°C to +60°C

Applications:

- Control circuits
- Broadcast and studio applications
- Audio interconnects
- Suggested voltage rating: 300 volts

Features:

- Impact- and abrasion-resistant
- Stranded conductors for superior flexibility
- Designed to meet UL VW-1 Vertical Wire Flame Test

Compliance:

- RoHS Compliant Directive 2002/95/EC

Packaging:

- Please contact Customer Service for packaging and color options

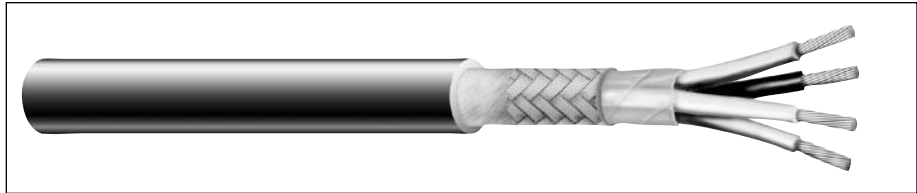

CATALOG NUMBER	NO. OF COND.	AWG SIZE	COND. STRAND	NOM. INSULATION THICKNESS		NOM. JACKET THICKNESS		NOMINAL O.D.	
				INCHES	mm	INCHES	mm	INCHES	mm
C1202	2	18	41/34	0.020	0.51	0.035	0.89	0.295	7.49
C1203	3	18	41/34	0.020	0.51	0.035	0.89	0.305	7.75
C1204	4	18	41/34	0.020	0.51	0.035	0.89	0.330	8.38
C1206	6	18	41/34	0.020	0.51	0.035	0.89	0.370	9.39
C1208	8	18	41/34	0.020	0.51	0.035	0.89	0.420	10.67
C1210	10	18	41/34	0.020	0.51	0.035	0.89	0.425	10.80
C1212	12	18	41/34	0.020	0.51	0.065	1.65	0.555	14.10
C1602	2	16	65/34	0.025	0.64	0.035	0.89	0.335	8.51
C1603	3	16	65/34	0.025	0.64	0.035	0.89	0.355	9.02
C1604	4	16	65/34	0.025	0.64	0.035	0.89	0.385	9.78
C1606	6	16	65/34	0.025	0.64	0.040	1.02	0.445	11.30
C1608	8	16	65/34	0.025	0.64	0.040	1.02	0.510	12.95
C1612	2	14	41/30	0.030	0.76	0.040	1.02	0.395	10.03
C1614	4	14	41/30	0.030	0.76	0.040	1.02	0.455	11.56

Color Code Chart

NO. OF COND.	COLOR	NO. OF COND.	COLOR
1	Black	7	Yellow
2	White	8	Orange
3	Red	9	Gray
4	Green	10	Violet
5	Blue	11	White/Black
6	Brown	12	White/Red

Communication & Control Cable, Multi-Paired

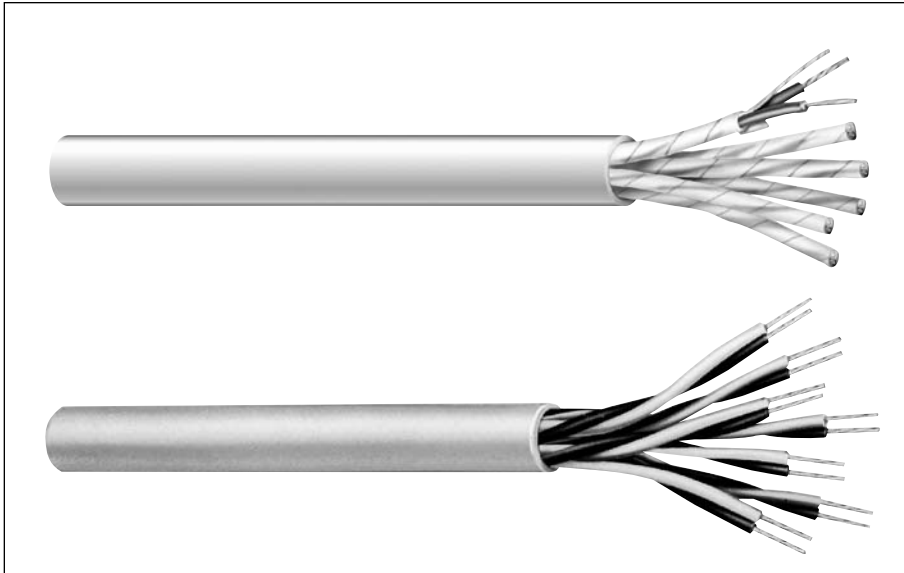

In many electronic applications, two wires are required to complete circuits; these are often referred to as “balanced arrays” or “twisted pair” constructions.

Paired cable designs find frequent application in circuits requiring circuit-to-circuit isolation from noise, minimization of capacitance imbalances and a reduction of EMI interference currents.

Circuit separation is further enhanced in those designs employing individual circuit shields in concert with an overall shield. These shielding systems are available from General Cable in myriad combinations to suit the unique needs of the circuit designer.

As with the multi-conductor designs, a wide array of insulating and jacketing materials are available to meet specific electronic applications.

General Cable’s Carol® Brand communication cable products are manufactured to meet the latest UL, CSA and NEC requirements and approvals.

Index	Page
Multi-Paired, Unshielded	43-45
Multi-Paired, Foil Shield	46-52
Multi-Paired, Foil Shield (CSA)	53-54
Multi-Paired, Foil Shield, Mid-Cap	55
Multi-Paired, Foil Shield, Lo-Cap®	56
Multi-Paired, Overall Foil & TC Braid Shield, Lo-Cap®	57
Multi-Paired, Individually Shielded	58
Multi-Paired, Individually Shielded (CSA)	59
Multi-Paired, Individually Shielded, Overall Shield	60
Multi-Paired, Individually Foil Shielded	61-64
Power-Limited Tray Cable, Individually Shielded	65
Power-Limited Tray Cable, Foil Shield or Foil/Braid Shield	66

Multi-Paired, Unshielded

UL 2464, NEC Type CM (UL) c(UL), CSA CMG

Product Construction:

Conductor:

- 22 AWG fully annealed solid or stranded tinned copper per ASTM B-33
- Twisted pairs

Insulation:

- Premium-grade, color-coded S-R PVC
- Color code: See chart below

Jacket:

- PVC, gray
- Temperature range: -20°C to +80°C

Applications:

- Computers
- Industrial equipment
- Data transmission
- Control circuits
- Suitable for EIA RS-232 applications
- Suggested voltage rating: 300 volts

Compliances:

- NEC Article 800 Type CM (UL: 75°C)
- UL Style 2464 (UL: 80°C, 300V)
- CSA CMG (CSA: 60°C)
- RoHS Compliant Directive 2002/95/EC
- Designed to meet UL 70,000 BTU Vertical Tray Flame Test
- Passes CSA CMG Flame Test

Packaging:

- Please contact Customer Service for packaging and color options



CATALOG NUMBER	NO. OF PAIRS	AWG SIZE	COND. STRAND	NOM. INSULATION THICKNESS		NOM. JACKET THICKNESS		NOMINAL O.D.		NOM. C-C CAP.* pF/ft
				INCHES	mm	INCHES	mm	INCHES	mm	
C4008A	1	22	Solid	0.010	0.25	0.032	0.81	0.156	3.94	24.5
C4010A	2	22	Solid	0.010	0.25	0.032	0.81	0.218	5.54	24.5
C4014A	3	22	Solid	0.010	0.25	0.032	0.81	0.229	5.82	24.5
C4015A	4	22	Solid	0.010	0.25	0.032	0.81	0.249	6.32	24.5
C4017A	6	22	Solid	0.012	0.30	0.032	0.81	0.293	7.44	24.5
C6010A	2	22	7/30	0.010	0.25	0.032	0.81	0.228	5.79	24.5
C6014A	3	22	7/30	0.010	0.25	0.032	0.81	0.240	6.10	24.5
C6015A	4	22	7/30	0.010	0.25	0.032	0.81	0.262	6.65	24.5
C6017A	6	22	7/30	0.010	0.25	0.032	0.81	0.300	7.62	24.5
C6019A	9	22	7/30	0.010	0.25	0.032	0.81	0.366	9.30	24.5
C6023A	12	22	7/30	0.010	0.25	0.032	0.81	0.410	10.40	24.5
C6026A	15	22	7/30	0.010	0.25	0.032	0.81	0.456	11.58	24.5

* Capacitance between conductors

Color Code Chart

NO. OF PAIRS	COLOR	NO. OF PAIRS	COLOR
1	Black paired with Red	9	Red paired with Green
2	Black paired with White	10	Red paired with Blue
3	Black paired with Green	11	Red paired with Yellow
4	Black paired with Blue	12	Red paired with Brown
5	Black paired with Yellow	13	Red paired with Orange
6	Black paired with Brown	14	Green paired with White
7	Black paired with Orange	15	Green paired with Blue
8	Red paired with White		

Multi-Paired, Unshielded

UL 2464, NEC Type CM (UL) c(UL), CSA CMG

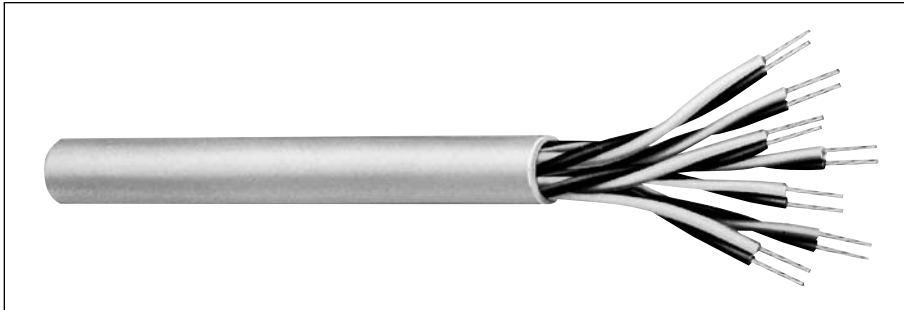

Product Construction:

Conductor:

- 18 AWG fully annealed stranded tinned copper per ASTM B-33
- Twisted pairs

Insulation:

- Premium-grade, color-coded S-R PVC
- Color code: See chart below

Jacket:

- PVC, gray
- Temperature range: -20°C to +80°C

Applications:

- Computers
- Industrial equipment
- Data transmission
- Control circuits
- Suitable for EIA RS-232 applications
- Suggested voltage rating: 300 volts

Compliances:

- NEC Article 800 Type CM (UL: 75°C)
- UL Style 2464 (UL: 80°C, 300V)
- CSA CMG (CSA: 60°C)
- RoHS Compliant Directive 2002/95/EC
- Designed to meet UL 70,000 BTU Vertical Tray Flame Test
- Passes CSA CMG Flame Test

CATALOG NUMBER	NO. OF PAIRS	AWG SIZE	COND. STRAND	NOM. INSULATION THICKNESS		NOM. JACKET THICKNESS		NOMINAL O.D.		NOM. C-C CAP* pF/ft
				INCHES	mm	INCHES	mm	INCHES	mm	
C6101A	1	18	16/30	0.013	0.33	0.032	0.81	0.206	5.23	26.3
C6118A	2	18	16/30	0.013	0.33	0.032	0.81	0.320	8.13	26.3
C6103A	3	18	16/30	0.013	0.33	0.032	0.81	0.338	8.59	26.3
C6119A	4	18	16/30	0.013	0.33	0.032	0.81	0.372	9.45	26.3
C6120A	5	18	16/30	0.013	0.33	0.032	0.81	0.408	10.36	26.3
C6106A	6	18	16/30	0.013	0.33	0.032	0.81	0.445	11.30	26.3
C6121A	8	18	16/30	0.013	0.33	0.032	0.81	0.484	12.29	26.3
C6109A	9	18	16/30	0.013	0.33	0.032	0.81	0.522	13.26	26.3
C6111A	15	18	16/30	0.013	0.33	0.032	0.81	0.659	16.74	26.3

* Capacitance between conductors

Color Code Chart

NO. OF PAIRS	COLOR	NO. OF PAIRS	COLOR
1	Black paired with Red	9	Red paired with Green
2	Black paired with White	10	Red paired with Blue
3	Black paired with Green	11	Red paired with Yellow
4	Black paired with Blue	12	Red paired with Brown
5	Black paired with Yellow	13	Red paired with Orange
6	Black paired with Brown	14	Green paired with White
7	Black paired with Orange	15	Green paired with Blue
8	Red paired with White		

Packaging:

- Please contact Customer Service for packaging and color options



Multi-Paired, Unshielded

NEC Type CMP (UL) c(UL)

Product Construction:

Conductor:

- 18 AWG fully annealed stranded tinned copper per ASTM B-33

Insulation:

- Premium-grade, color-coded FEP
- Color code: See chart below

Jacket:

C8116

- FEP, red or as requested
- Temperature range: -40°C to +200°C

C8122

- Flexguard® PVC, natural
- Temperature range: -20°C to +75°C

Applications:

- Audio systems
- Remote control circuits
- Process control and instrumentation
- Suggested voltage rating: 300 volts

Compliances:

- NEC Article 800
- Designed to meet NFPA 262 and CSA FT-6 Steiner Tunnel Fire Tests for Plenum Applications

Features:

- Fire-retardant, low-smoke jacket

Packaging:

- Please contact Customer Service for packaging and color options

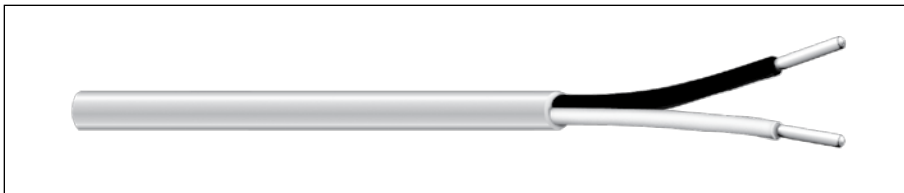

CATALOG NUMBER	NO. OF PAIRS	AWG SIZE	COND. STRAND	NOM. INSULATION THICKNESS		NOM. JACKET THICKNESS		NOMINAL O.D.		NOM. C-C CAP.* pF/ft
				INCHES	mm	INCHES	mm	INCHES	mm	
C8116	1	18	19/30	0.007	0.18	0.009	0.23	0.142	3.61	20.0
C8122	1	18	19/30	0.007	0.18	0.015	0.38	0.154	3.91	20.0

*Capacitance between conductors

Color Code Chart

NO. OF PAIRS	COLOR
1	Black and Red

Multi-Paired, Foil Shield

NEC Type CM (UL) c(UL), CSA CMG

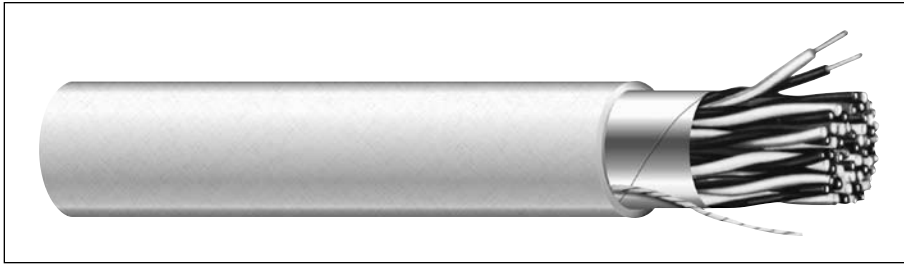

Product Construction:

Conductor:

- 22 AWG fully annealed solid or stranded tinned copper per ASTM B-33
- Twisted pairs

Insulation:

- Premium-grade, color-coded S-R PVC
- Color code: See chart below

Shield:

- 100% Flexfoil® aluminum/polyester, 25% overlap, foil facing out
- Stranded tinned copper drain wire

Jacket:

- PVC, gray
- Temperature range: -20°C to +75°C

Applications:

- Audio systems
- Communication circuits
- Instrumentation and control use
- Suggested voltage rating: 300 volts

Compliances:

- NEC Article 800 Type CM (UL: 75°C, 300V)
- CSA CMG (CSA: 60°C)
- RoHS Compliant Directive 2002/95/EC
- Designed to meet UL 70,000 BTU Vertical Tray Flame Test
- Passes CSA CMG Flame Test

Packaging:

- Please contact Customer Service for packaging and color options

CATALOG NUMBER	NO. OF PAIRS	AWG SIZE	COND. STRAND	NOM. INSULATION THICKNESS		NOM. JACKET THICKNESS		NOMINAL O.D.		NOMINAL CAP.*	
				INCHES	mm	INCHES	mm	INCHES	mm	A	B
C7104A†	1	22	7/0096	0.013	0.33	0.035	0.89	0.185	4.70	35.0	62.0
C1670A	2	22	Solid	0.010	0.25	0.032	0.81	0.218	5.54	32.0	57.0
C1676A	4	22	Solid	0.010	0.25	0.032	0.81	0.249	6.32	28.0	50.0
C1671A	6	22	Solid	0.010	0.25	0.032	0.81	0.292	7.42	25.0	45.0
C1672A	9	22	Solid	0.010	0.25	0.032	0.81	0.338	8.59	25.0	45.0
C1673A	15	22	Solid	0.010	0.25	0.032	0.81	0.419	10.64	25.0	45.0

*A – Capacitance between conductors

*B – Capacitance between one conductor and other conductors connected to shield

† Also UL Style 2464 (UL: 80°C, 300V)

Color Code Chart

NO. OF PAIRS	COLOR	NO. OF PAIRS	COLOR
1	Black paired with Red	9	Red paired with Green
2	Black paired with White	10	Red paired with Blue
3	Black paired with Green	11	Red paired with Yellow
4	Black paired with Blue	12	Red paired with Brown
5	Black paired with Yellow	13	Red paired with Orange
6	Black paired with Brown	14	Green paired with White
7	Black paired with Orange	15	Green paired with Blue
8	Red paired with White		



Underwriters Laboratories Inc.



Multi-Paired, Foil Shield

UL 2095, NEC Type CM (UL) c(UL)

Product Construction:

Conductor:

- 22 AWG fully annealed solid tinned copper per ASTM B-33
- Twisted pairs

Insulation:

- Premium-grade, color-coded S-R PVC
- Color code: See chart below

Shield:

- 100% Flexfoil® aluminum/polyester, 25% overlap, foil facing out
- Stranded tinned copper drain wire

Jacket:

- PVC, gray
- Temperature range: -20°C to +80°C

Applications:

- Intercom systems
- Sound systems
- Electronic instrumentation control systems
- Suggested voltage rating: 300 volts

Compliances:

- NEC Article 800 Type CM (UL: 75°C, 300V)
- UL Style 2095 (UL: 80°C, 300V)
- RoHS Compliant Directive 2002/95/EC
- Designed to meet UL 70,000 BTU Vertical Tray Flame Test

Packaging:

- Please contact Customer Service for packaging and color options



CATALOG NUMBER	NO. OF PAIRS	AWG SIZE	COND. STRAND	NOM. INSULATION THICKNESS		NOM. JACKET THICKNESS		NOMINAL O.D.		NOMINAL CAP.*	
				INCHES	mm	INCHES	mm	INCHES	mm	A	B
C6451A	51	22	Solid	0.010	0.25	0.050	1.27	0.715	18.16	25.0	45.0

*A – Capacitance between conductors

*B – Capacitance between one conductor and other conductors connected to shield

Color Code Chart

NO. OF PAIRS	COLOR	NO. OF PAIRS	COLOR	NO. OF PAIRS	COLOR
1	Blue paired with White	18	Brown/White striped paired with White	35	Green/White striped paired with Red
2	Orange paired with White			36	Green/Brown striped paired with Red
3	Green paired with White	19	Brown/Gray striped paired with White	37	Green/Gray striped paired with Red
4	Brown paired with White			38	Brown/White striped paired with Red
5	Gray paired with White	20	Gray/White striped paired with White	39	Brown/Gray striped paired with Red
6	Blue/White striped paired with White			40	Gray/White striped paired with Red
7	Blue/Orange striped paired with White	21	Blue paired with Red	41	Blue paired with Black
		22	Orange paired with Red		
8	Blue/Green striped paired with White	23	Green paired with Red	42	Orange paired with Black
		24	Brown paired with Red		
9	Blue/Brown striped paired with White	25	Gray paired with Red	43	Green paired with Black
		26	Blue/White striped paired with Red		
10	Blue/Gray striped paired with White	27	Blue/Orange striped paired with Red	44	Brown paired with Black
11	Orange/White striped paired with White	29	Blue/Brown striped paired with Red	45	Gray paired with Black
12	Orange/Green striped paired with White	31	Orange/White striped paired with Red	46	Blue/White striped paired with Black
13	Orange/Brown striped paired with White	33	Orange/Brown striped paired with Red	47	Blue/Orange striped paired with Black
14	Orange/Gray striped paired with White	35	Orange/Gray striped paired with Red	48	Blue/Green striped paired with Black
15	Green/White striped paired with White	37	Green/White striped paired with Red	49	Blue/Brown striped paired with Black
16	Green/Brown striped paired with White	39	Green/Brown striped paired with Red	50	Blue/Gray striped paired with Black
17	Green/Gray striped paired with White	41	Brown/White striped paired with Red	51	Orange/White striped paired with Black

Multi-Paired, Foil Shield

NEC Type CMP (UL) c(UL)

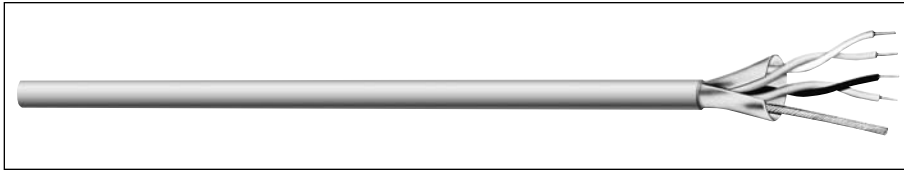

Product Construction:

Conductor:

- 22 and 24 AWG fully annealed stranded tinned copper per ASTM B-33

Insulation:

- Premium-grade, color-coded fluoropolymer
- Color code: See chart below

Shield:

- 100% Flexfoil® aluminum/polyester foil with 25% overlap, minimum
- Stranded tinned copper drain wire

Jacket:

- Fluoropolymer, natural
- Temperature range: -40°C to +150°C
- Sequential footage marked to facilitate installation
- Includes ripcord

Applications:

- EIA RS-232 circuits
- Remote control circuits
- Process control and instrumentation
- Power-limited control circuits
- Suggested voltage rating: 300 volts

Compliances:

- NEC Article 800 (UL: 150°C, 300V)
- Designed to meet NFPA 262 and CSA FT-6 Steiner Tunnel Fire Tests for Plenum Applications

Features:

- Water-resistant jacket

Packaging:

- Please contact Customer Service for packaging and color options

CATALOG NUMBER	NO. OF PAIRS	AWG SIZE	COND. STRAND	NOM. INSULATION THICKNESS		NOM. JACKET THICKNESS		NOMINAL O.D.		NOM. CAP.*	
				INCHES	mm	INCHES	mm	INCHES	mm	A	B
22 AWG CONDUCTORS											
C3204	1	22	7/30	0.006	0.15	0.010	0.25	0.117	2.97	31.0	55.8
C3205	2	22	7/30	0.006	0.15	0.010	0.25	0.151	3.84	25.0	45.0
C3206	3	22	7/30	0.006	0.15	0.010	0.25	0.177	4.50	25.0	36.0
C3207	4	22	7/30	0.006	0.15	0.010	0.25	0.200	5.08	20.0	45.0
C3208	6	22	7/30	0.006	0.15	0.010	0.25	0.237	6.02	18.0	32.4
24 AWG CONDUCTORS											
C3150	2	24	7/32	0.006	0.15	0.010	0.25	0.130	3.30	22.0	39.6
C3153	3	24	7/32	0.006	0.15	0.010	0.25	0.152	3.86	18.0	32.4
C3151	4	24	7/32	0.006	0.15	0.010	0.25	0.170	4.32	17.0	30.6
C3165	6	24	7/32	0.006	0.15	0.010	0.25	0.200	5.08	17.0	30.6
C3152	12.5	24	7/32	0.006	0.15	0.012	0.30	0.290	7.04	17.0	30.6

*A – Capacitance between conductors

*B – Capacitance between one conductor and other conductors connected to shield

Color Code Chart

NO. OF PAIRS	COLOR
1	Black & Yellow
2	Red & Violet
3	Dark Blue & Brown
4	Orange & Dark Green
5	Pink & Gray
6	Tan & White
7	Light Blue & Light Green
8	Red/White & White/Red
9	Orange/White & White/Orange
10	Yellow/White & White/Yellow
11	Gray/White & White/Gray
12	Blue/White & White/Blue
1C	Dark Green/Yellow



Designed to Meet
NFPA 262 and CSA FT-6
Steiner Tunnel Fire Tests
for Plenum Applications

Underwriters Laboratories Inc.



Multi-Paired, Foil Shield

NEC Type CMP (UL) c(UL)

Product Construction:

Conductor:

- 22 and 18 AWG fully annealed stranded tinned copper per ASTM B-33

Insulation:

- Premium-grade, color-coded FEP
- Color code: See chart below

Separator:

- Polyester tape with 25% overlap

Shield:

- 100% Flexfoil® aluminum/polyester foil with 25% overlap, minimum
- Stranded tinned copper drain wire

Jacket:

- FEP, red or as requested
- PVDF, red or as requested

C8101, C8109

- Temperature range: -40°C to +200°C

C8104, C8103

- Temperature range: -40°C to +150°C

Applications:

- Computer systems
- Remote control circuits
- Process control and instrumentation
- Suggested voltage rating: 300 volts

Compliances:

- NEC Article 800
- Designed to meet NFPA 262 and CSA FT-6 Steiner Tunnel Fire Tests for Plenum Applications

Features:

- Fire-retardant, low-smoke jacket

Packaging:

- Please contact Customer Service for packaging and color options
- 1000' (305m) reels

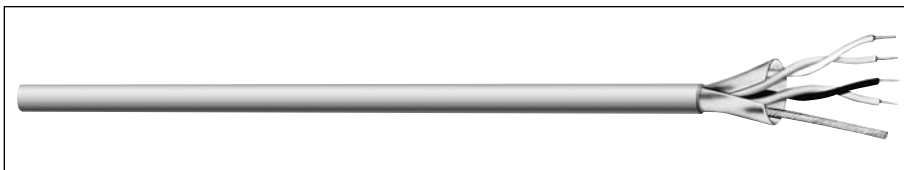

CATALOG NUMBER	NO. OF PAIRS	AWG SIZE	COND. STRAND	NOM. INSULATION THICKNESS		NOM. JACKET THICKNESS		NOMINAL O.D.		NOM. CAP.* pF/ft	
				INCHES	mm	INCHES	mm	INCHES	mm	A	B
C8101**	1	18	19/30	0.007	0.18	0.016	0.41	0.165	4.19	51.0	95.0
C8104	1	18	19/30	0.007	0.18	0.016	0.41	0.165	4.19	51.0	95.0
C8103	1	22	7/30	0.006	0.15	0.014	0.36	0.120	3.05	35.0	65.0
C8109**	1	22	7/30	0.006	0.15	0.016	0.41	0.122	3.10	35.0	65.0

*A – Capacitance between conductors

*B – Capacitance between one conductor and other conductors connected to shield

** FEP jacket

Color Code Chart

NO. OF PAIRS	COLOR
1	Black and Red

Multi-Paired, Foil Shield

NEC Type CMP (UL) c(UL)

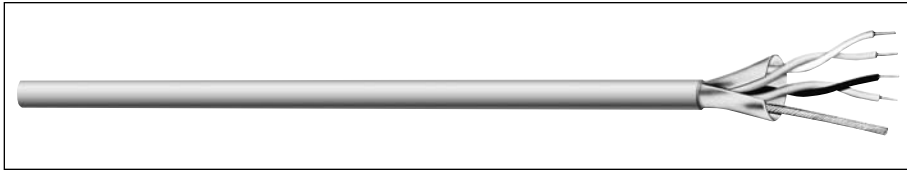

CATALOG NUMBER	NO. OF PAIRS	AWG SIZE	COND. STRAND	NOM. INSULATION THICKNESS		NOM. JACKET THICKNESS		NOMINAL O.D.		NOM. CAP.*	
				INCHES	mm	INCHES	mm	INCHES	mm	A	B
C8118	2	24	7/32	0.014	0.15	0.015	0.38	0.203	5.16	12.0	22.0

*A – Capacitance between conductors

*B – Capacitance between one conductor and other conductors connected to shield

Color Code Chart

NO. OF PAIRS	COLOR
1	White/Blue paired with Blue/White
2	White/Orange paired with Orange/White

Product Construction:

Conductor:

- 24 AWG fully annealed stranded tinned copper per ASTM B-33

Insulation:

- Premium-grade, color-coded foam FEP
- Color code: See chart below

Separator:

- Polyester tape with 25% overlap

Shield:

- 100% Flexfoil® aluminum/polyester foil with 25% overlap, minimum
- Stranded tinned copper drain wire

Jacket:

- PVDF, gray or as requested
- Temperature range: -40°C to +150°C

Applications:

- Computer systems
- Remote control circuits
- Process control and instrumentation
- Suitable for RS232, RS422, RS485
- Suggested voltage rating: 300 volts

Compliances:

- NEC Article 800
- Designed to meet NFPA 262 and CSA FT-6 Steiner Tunnel Fire Tests for Plenum Applications

Features:

- Fire-retardant, low-smoke jacket

Packaging:

- Please contact Customer Service for packaging and color options



Designed to Meet
NFPA 262 and CSA FT-6
Steiner Tunnel Fire Tests
for Plenum Applications

Underwriters Laboratories Inc.



Multi-Paired, Foil Shield

NEC Type CMP (UL) c(UL)

Product Construction:

Conductor:

- 24, 22 and 18 AWG fully annealed stranded tinned copper per ASTM B-33

Insulation:

- Premium-grade, color-coded FEP
- Color code: See chart below

Separator:

- Polyester tape with 25% overlap

Shield:

- 100% Flexfoil® aluminum/polyester foil with 25% overlap, minimum
- Stranded tinned copper drain wire

Jacket:

- Flexguard® PVC, natural or as requested
- Temperature range: -20°C to +75°C

Applications:

- Computer systems
- Remote control circuits
- Process control and instrumentation
- Suggested voltage rating: 300 volts

Compliances:

- NEC Article 800
- Designed to meet NFPA 262 and CSA FT-6 Steiner Tunnel Fire Tests for Plenum Applications

Features:

- Fire-retardant, low-smoke jacket

Packaging:

- Please contact Customer Service for packaging and color options

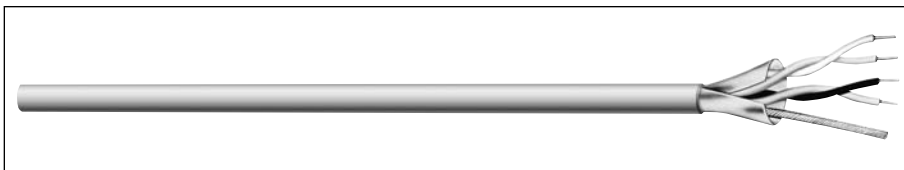

CATALOG NUMBER	NO. OF PAIRS	AWG SIZE	COND. STRAND	NOM. INSULATION THICKNESS		NOM. JACKET THICKNESS		NOMINAL O.D.		NOM. CAP.* pF/ft	
				INCHES	mm	INCHES	mm	INCHES	mm	A	B
C8127	1	24	7/32	0.006	0.15	0.014	0.36	0.108	2.69	30.0	60.0
C8113	3	24	7/32	0.006	0.15	0.014	0.36	0.161	4.09	25.0	45.0
C8126	1	22	7/30	0.006	0.15	0.014	0.36	0.120	3.05	35.0	65.0
C8123	1	18	19/30	0.007	0.18	0.014	0.36	0.160	4.06	51.0	90.0

*A – Capacitance between conductors

*B – Capacitance between one conductor and other conductors connected to shield

C8124**	1	22	7/30	0.007	0.18	0.017	0.43	0.128	3.25	32.0	62.0
----------------	---	----	------	-------	------	-------	------	-------	------	------	------

*A – Capacitance between conductors

*B – Capacitance between one conductor and other conductors connected to shield

**This item does not have a separator and has a shield fusible to the jacket to facilitate removal along with the jacket while stripping.

Color Code Chart

NO. OF PAIRS	COLOR
1	Black and Red
C8113	
NO. OF PAIRS	COLOR
1	Black paired with White
2	Black paired with Red
3	Black paired with Green

Multi-Paired, Foil Shield

NEC Type CMP (UL) c(UL) and/or CL2P

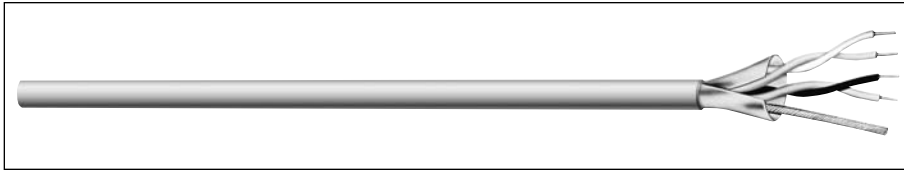

CATALOG NUMBER	NO. OF PAIRS	AWG SIZE	COND. STRAND	NOM. INSULATION THICKNESS		NOM. JACKET THICKNESS		NOMINAL O.D.		NOM. CAP.*	
				INCHES	mm	INCHES	mm	INCHES	mm	A	B
22 AWG, CL2P, c(UL) 150 VOLTS											
C3352	2	22	7/30 TC	0.007	0.180	0.010	0.25	0.157	3.99	37.0	66.0
C3353	3	22	7/30 TC	0.007	0.180	0.010	0.25	0.194	4.42	30.0	53.0
C3354	4	22	7/30 TC	0.007	0.180	0.010	0.25	0.207	4.75	30.0	53.0
C3356	6	22	7/30 TC	0.007	0.180	0.010	0.25	0.246	5.74	27.0	48.0
18 AWG, CL2P/CMP, c(UL) 150 VOLTS											
C3362	2	18	7/26 BC	0.008	0.020	0.010	0.25	0.205	5.21	44.0	79.0
C3364	4	18	7/26 BC	0.008	0.020	0.010	0.25	0.277	7.04	33.0	59.0

*A – Capacitance between conductors

*B – Capacitance between one conductor and other conductors connected to shield

Color Code Chart

NO. OF PAIRS	COLOR
1	Black & Yellow
2	Red & Violet
3	Dark Blue & Brown
4	Orange & Dark Green
5	Pink & Gray
6	Tan & White

Product Construction:

Conductor:

- 22 and 18 AWG fully annealed stranded tinned copper per ASTM B-33 or stranded bare copper per ASTM B-3

Insulation:

- Premium-grade, color-coded Flexguard® PVC
- Color code: See chart below

Shield:

- 100% Flexfoil® aluminum/polyester foil with 25% overlap, minimum
- Stranded tinned copper drain wire

Jacket:

- Fluoropolymer, natural
- Temperature range: -20°C to +75°C
- Sequential footage marked to facilitate installation
- Includes ripcord

Applications:

- EIA RS-232 circuits
- Remote control circuits
- Process control and instrumentation
- Power-limited control circuits
- Suggested voltage rating: 150 volts

Compliances:

- NEC Article 800 (UL: 75°C, 300V)
- NEC Article 725 (UL: 75°C, 150V)
- Designed to meet NFPA 262 and CSA FT-6 Steiner Tunnel Fire Tests for Plenum Applications

Features:

- Abrasion-, chemical- and water-resistant jacket

Packaging:

- Please contact Customer Service for packaging and color options



Designed to Meet
NFPA 262 and CSA FT-6
Steiner Tunnel Fire Tests
for Plenum Applications

Underwriters Laboratories Inc.



Multi-Paired, Foil Shield

AWM Style 2464, CSA Type AWM I/II A/B, NEC/CEC Type CMG (CSA C/US)

Product Construction:

Conductor:

- 24 AWG fully annealed stranded tinned copper per ASTM B-33
- Twisted pairs

Insulation:

- Premium-grade, color-coded PVC
- Color code: See chart below

Shield:

- 100% Flexfoil® aluminum/polyester, 25% overlap, foil facing out
- Stranded tinned copper drain wire

Jacket:

- PVC, gray
- Temperature range: -20°C to +105°C

Applications:

- Computers
- Industrial equipment
- Data transmission
- Control circuits
- Suitable for EIA RS-232 applications
- Suggested voltage rating: 300 or 600 volts

Features:

- Excellent electrical properties
- Superior shielding effectiveness
- 25% shield overlap provides excellent shielding efficiency
- Assists system designers in meeting FCC Docket 20780 demands
- Good flexibility

Compliances:

- AWM Style 2464 (CSA: 80°C, 300V)
- CSA Type AWM (105°C, 600V)
- CSA Certified CMG to harmonized standard UL444 and CSA 22.2 No. 214
- NEC/CEC Type CMG (CSA: 105°C, 300V)
- RoHS Compliant Directive 2002/95/EC
- Designed to meet CSA 70,000 BTU Vertical Tray Flame Test
- Passes CSA FT4 Vertical Flame Test

Packaging:

- Please contact Customer Service for packaging and color options



CATALOG NUMBER	NO. OF PAIRS	AWG SIZE	COND. STRAND	NOM. INSULATION THICKNESS		NOM. JACKET THICKNESS		NOMINAL O.D.		NOMINAL DCR Ω/KFT	COND. SHLD.	COLOR CODE	NOM. CAP.* pF/ft	
				INCHES	mm	INCHES	mm	INCHES	mm				A	B
C4170A	1	24	7/32	0.010	0.25	0.032	0.81	0.157	3.99	26.0	18.0	1	36.4	65.5
C4209A	1	24	7/32	0.010	0.25	0.032	0.81	0.157	3.99	26.0	18.0	Wht/Blk	36.4	65.5
C4191A	1	24	7/32	0.009	0.23	0.030	0.76	0.148	3.78	26.0	16.5	Blk/Red	43.0	78.0
C4171A	2	24	7/32	0.010	0.25	0.032	0.81	0.214	5.44	26.0	18.0	1	31.9	57.3
C4172A	3	24	7/32	0.010	0.25	0.032	0.81	0.225	5.72	26.0	16.5	1	28.6	51.4
C4173A	4	24	7/32	0.010	0.25	0.032	0.81	0.245	6.22	26.0	16.5	1	28.6	51.4
C4174A	5	24	7/32	0.010	0.25	0.032	0.81	0.265	6.73	26.0	16.5	1	28.6	51.4
C4175A	6	24	7/32	0.010	0.25	0.032	0.81	0.287	7.29	26.0	15.2	1	26.3	47.5
C4176A	7	24	7/32	0.010	0.25	0.032	0.81	0.287	7.29	26.0	15.2	1	26.3	47.5
C4177A	8	24	7/32	0.010	0.25	0.032	0.81	0.309	7.85	26.0	15.0	1	26.3	47.5
C4178A	9	24	7/32	0.010	0.25	0.032	0.81	0.331	8.41	26.0	15.0	1	26.3	47.5
C4179A	10	24	7/32	0.010	0.25	0.032	0.81	0.359	9.12	26.0	14.0	1	26.3	47.5
C4180A	15	24	7/32	0.010	0.25	0.032	0.81	0.410	10.41	26.0	13.8	1	26.3	47.5
C4181A	19	24	7/32	0.010	0.25	0.032	0.81	0.432	10.97	26.0	13.5	1	26.3	47.5
C4182A	25	24	7/32	0.010	0.25	0.032	0.81	0.505	12.83	26.0	12.7	1	26.3	47.5

*A - Capacitance between conductors

*B - Capacitance between one conductor and other conductors connected to shield

Color Code Chart

NO. OF PAIRS	COLOR	NO. OF PAIRS	COLOR
1	Black with Red	14	Green with White
2	Black with White	15	Green with Blue
3	Black with Green	16	Green with Yellow
4	Black with Blue	17	Green with Brown
5	Black with Yellow	18	Green with Orange
6	Black with Brown	19	White with Blue
7	Black with Orange	20	White with Yellow
8	Red with White	21	White with Brown
9	Red with Green	22	White with Orange
10	Red with Blue	23	Blue with Yellow
11	Red with Yellow	24	Blue with Brown
12	Red with Brown	25	Blue with Orange
13	Red with Orange		

Multi-Paired, Foil Shield

AWM Style 2464, CSA Type AWM I/II A/B, NEC/CEC Type CMG (CSA C/US)



Product Construction:

Conductor:

- 22 AWG fully annealed stranded tinned copper per ASTM B-33
- Twisted pairs

Insulation:

- Premium-grade, color-coded PVC
- Color code: See chart below

Shield:

- 100% Flexfoil® aluminum/polyester, 25% overlap, foil facing out
- Stranded tinned copper drain wire

Jacket:

- PVC, gray
- Temperature range: -20°C to +105°C

Applications:

- Computers
- Industrial equipment
- Data transmission
- Control circuits
- Suitable for EIA RS-232 applications
- Suggested voltage ratings: 300 or 600 volts

Features:

- Excellent electrical properties
- Superior shielding effectiveness
- 25% shield overlap provides excellent shielding efficiency
- Assists system designers in meeting FCC Docket 20780 demands
- Good flexibility

Compliances:

- AWM Style 2464 (CSA: 80°C, 300V)
- CSA Type AWM (105°C, 600V)
- CSA Certified CMG to harmonized standard UL444 and CSA 22.2 No. 214
- NEC/CEC Type CMG (CSA: 105°C, 300V)
- RoHS Compliant Directive 2002/95/EC
- Designed to meet CSA 70,000 BTU Vertical Tray Flame Test
- Passes CSA FT4 Vertical Flame Test

Packaging:

- Please contact Customer Service for packaging and color options

CATALOG NUMBER	NO. OF PAIRS	AWG SIZE	COND. STRAND	NOMINAL INSULATION THICKNESS		NOMINAL JACKET THICKNESS		NOMINAL O.D.		NOMINAL DCR		NOMINAL CAP*	
				INCHES	mm	INCHES	mm	INCHES	mm	COND.	SHLD.	A	B
C4183A	1	22	7/30	0.010	0.25	0.032	0.81	0.169	4.29	15.0	18.0	44.8	80.7
C4184A	2	22	7/30	0.010	0.25	0.032	0.81	0.234	5.94	15.0	16.5	35.9	64.6
C4185A	3	22	7/30	0.010	0.25	0.032	0.81	0.246	6.25	15.0	16.5	30.9	55.7
C4186A	4	24	7/30	0.010	0.25	0.032	0.81	0.269	6.83	15.0	16.5	30.9	55.7
C4187A	5	22	7/30	0.010	0.25	0.032	0.81	0.294	7.47	15.0	16.5	30.9	55.7
C4188A	6	22	7/30	0.010	0.25	0.032	0.81	0.320	8.13	15.0	16.5	28.4	51.0
C4189A	9	22	7/30	0.010	0.25	0.032	0.81	0.367	9.32	15.0	16.5	28.4	51.0
C4190A	15	22	7/30	0.010	0.25	0.032	0.81	0.457	11.61	15.0	16.5	28.4	51.0

*A – Capacitance between conductors

*B – Capacitance between one conductor and other conductors connected to shield

Color Code Chart

NO. OF PAIRS	COLOR	NO. OF PAIRS	COLOR
1	Black with Red	9	Red with Green
2	Black with White	10	Red with Blue
3	Black with Green	11	Red with Yellow
4	Black with Blue	12	Red with Brown
5	Black with Yellow	13	Red with Orange
6	Black with Brown	14	Green with White
7	Black with Orange	15	Green with Blue
8	Red with White		



Multi-Paired, Foil Shield, Mid-Cap

NEC Type CMP (UL) c(UL)

Product Construction:

Conductor:

- 24 AWG fully annealed stranded tinned copper per ASTM B-33

Insulation:

- Premium-grade, color-coded fluoropolymer
- Color code: See chart below

Shield:

- 100% Flexfoil® aluminum/polyester foil with 25% overlap, minimum
- Stranded tinned copper drain wire

Jacket:

- Fluoropolymer, natural
- Temperature range: -40°C to +150°C
- Sequential footage marked to facilitate installation
- Includes ripcord

Applications:

- EIA RS-232 and RS-422 circuits
- Remote control circuits
- Process control and instrumentation
- Power-limited control circuits
- Suggested voltage rating: 300 volts

Compliances:

- NEC Article 800 (UL: 150°C, 300V)
- Designed to meet NFPA 262 and CSA FT-6 Steiner Tunnel Fire Tests for Plenum Applications

Features:

- Abrasion-, chemical- and water-resistant jacket

Packaging:

- Please contact Customer Service for packaging and color options

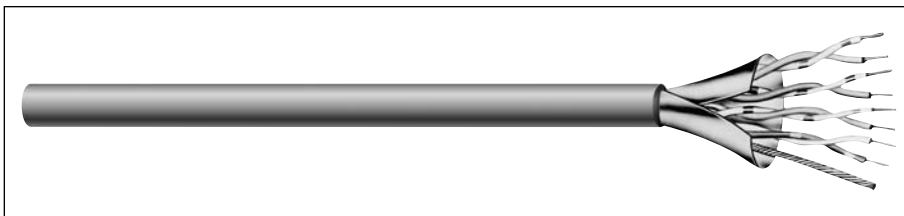

CATALOG NUMBER	NO. OF PAIRS	AWG SIZE	COND. STRAND	NOM. INSULATION THICKNESS		NOM. JACKET THICKNESS		NOMINAL O.D.		NOM. CAP.*	
				INCHES	mm	INCHES	mm	INCHES	mm	A	B
C3214	2	24	7/32	0.010	0.25	0.010	0.25	0.150	3.81	17.0	30.0
C3215	3	24	7/32	0.010	0.25	0.010	0.25	0.177	4.50	15.0	27.0
C3216	4	24	7/32	0.010	0.25	0.010	0.25	0.201	5.11	15.0	27.0
C3217	4.5	24	7/32	0.010	0.25	0.010	0.25	0.214	5.18	15.0	27.0
C3218	6	24	7/32	0.010	0.25	0.010	0.25	0.239	6.07	14.0	25.0

*A – Capacitance between conductors

*B – Capacitance between one conductor and other conductors connected to shield

Color Code Chart

NO. OF PAIRS	COLOR
1	Black paired with Yellow
2	Red paired with Violet
3	Dark Blue paired with Brown
4	Orange paired with Dark Green
5	Pink paired with Gray
6	Tan paired with White
1C	Green with Yellow Stripe

Multi-Paired, Foil Shield, Lo-Cap®

NEC Type CMP (UL) c(UL)

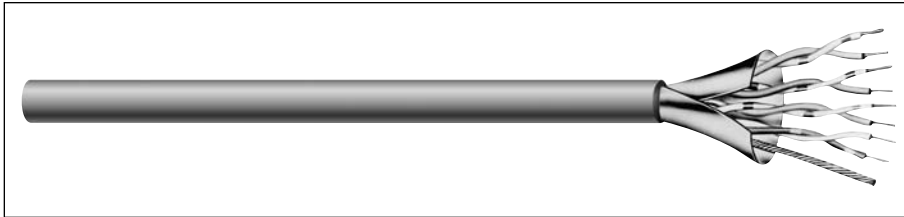

CATALOG NUMBER	NO. OF PAIRS	AWG SIZE	COND. STRAND	NOM. JACKET THICKNESS		NOMINAL O.D.		NOM. CAP.* pF/ft		IMPED. Ω NOM
				INCHES	mm	INCHES	mm	A	B	
C3028	2	24	7/32	0.010	0.25	0.159	4.04	15.0	27.00	94.0
C3029	3	24	7/32	0.010	0.25	0.183	4.65	14.0	25.00	107.0
C3030	4	24	7/32	0.010	0.25	0.246	6.25	14.0	25.00	107.0
C3031	6	24	7/32	0.012	0.30	0.285	7.24	13.0	23.00	115.0

*A – Capacitance between conductors

*B – Capacitance between one conductor and other conductors connected to shield

Color Code Chart

NO. OF PAIRS	COLOR
1	Black paired with Yellow
2	Red paired with Violet
3	Dark Blue paired with Brown
4	Orange paired with Dark Green
5	Pink paired with Gray
6	Tan paired with White

Product Construction:

Conductor:

- 24 AWG fully annealed stranded tinned copper per ASTM B-33

Insulation:

- Premium-grade, color-coded fluoropolymer
- Color code: See chart below

Shield:

- 100% Flexfoil® aluminum/polyester foil with 25% overlap, minimum
- Stranded tinned copper drain wire

Jacket:

- Fluoropolymer, natural
- Temperature range: -40°C to +150°C
- Sequential footage marked to facilitate installation
- Includes ripcord

Applications:

- EIA RS-232 and RS-422 circuits
- Remote control circuits
- Process control and instrumentation
- Low capacitance requirements
- Suggested voltage rating: 300 volts

Compliances:

- NEC Article 800 (UL: 150°C, 300V)
- Designed to meet NFPA 262 and CSA FT-6 Steiner Tunnel Fire Tests for Plenum Applications

Features:

- Abrasion-, chemical- and water-resistant jacket

Packaging:

- Please contact Customer Service for packaging and color options



Designed to Meet
NFPA 262 and CSA FT-6
Steiner Tunnel Fire Tests
for Plenum Applications

Underwriters Laboratories Inc.



Multi-Paired, Overall Foil & TC Braid Shield, Lo-Cap®

NEC Type CMP (UL) c(UL)

Product Construction:

Conductor:

- 24 AWG fully annealed stranded tinned copper per ASTM B-33

Insulation:

- Premium-grade, color-coded foam FEP
- Color code: See chart below

Shield:

- 100% Flexfoil® aluminum/polyester foil with 25% overlap, minimum
- Tinned copper braid, 90% coverage

Jacket:

C8117

- FEP, red or as requested
- Temperature range: -40°C to +200°C

C8129

- Flexguard® PVC, natural
- Temperature range: -20°C to +75°C

Applications:

- Computer systems
- Remote control circuits
- Process control and instrumentation
- Suggested voltage rating: 300 volts

Compliances:

- NEC Article 800
- Designed to meet NFPA 262 and CSA FT-6 Steiner Tunnel Fire Tests for Plenum Applications

Features:

- Fire-retardant, low-smoke jacket

Packaging:

- Please contact Customer Service for packaging and color options

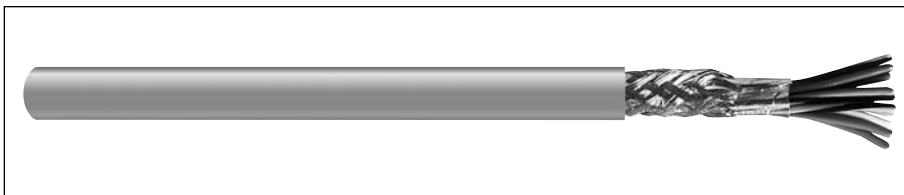

CATALOG NUMBER	NO. OF PAIRS	AWG SIZE	COND. STRAND	NOM. INSULATION THICKNESS		NOM. JACKET THICKNESS		NOMINAL O.D.		NOM. CAP.* pF/ft	
				INCHES	mm	INCHES	mm	INCHES	mm	A	B
C8117	1	24	7/32	0.026	0.66	0.014	0.36	0.208	5.28	12.0	22.0
C8129	2	24	7/32	0.019	0.48	0.017	0.43	0.280	6.93	12.0	22.0

*A – Capacitance between conductors

*B – Capacitance between one conductor and other conductors connected to shield

Color Code Chart

C8117 NO. OF PAIRS	COLOR
1	White/Blue paired with Blue/White

C8129 NO. OF PAIRS	COLOR
1	White/Blue paired with Blue/White
2	White/Orange paired with Orange/White

Multi-Paired, Individually Shielded

UL 2717, UL 2835, NEC Type CM (UL) c(UL) CMH or CMG

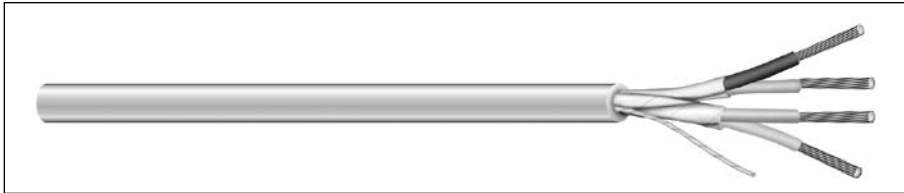

Product Construction:

Conductor:

- 22 AWG fully annealed stranded tinned copper per ASTM B-33
- Twisted pairs

Insulation:

- Premium-grade, color-coded polypropylene
- Color code: See chart below

Shield:

- Individually shielded pairs
- 100% Flexfoil® aluminum/polyester, 25% overlap, foil facing out
- Stranded tinned copper drain wire

Jacket:

- PVC, gray
- Temperature range: -20°C to +80°C

Applications:

- Where total isolation of signal is required
- Computers
- Control circuits
- Industrial equipment
- Suggested voltage rating: 300 volts

Features:

- Excellent high frequency properties
- Mechanical durability

Compliances:

- NEC Article 800 Type CM (UL: 75°C, 300V)
- UL Style 2717 (UL: 80°C)
- UL Style 2835 (UL: 60°C, 30V)
- UL Style 2464 (UL: 80°C, 300V)
- CSA CMH (CSA: 60°C)
- CSA CMG (CSA: 60°C)
- RoHS Compliant Directive 2002/95/EC
- Designed to meet CSA 70,000 BTU Vertical Tray Flame Test
- Passes CSA CMH or CMG Flame Test

Packaging:

- Please contact Customer Service for packaging and color options

CATALOG NUMBER	NO. OF PAIRS	AWG SIZE	COND. STRAND	NOM. INSULATION THICKNESS		NOM. JACKET THICKNESS		NOMINAL O.D.		NOMINAL CAP.*	
				INCHES	mm	INCHES	mm	INCHES	mm	A	B
POLYPROPYLENE INSULATION – NEC TYPE CM(UL) c(UL) CMH											
C1352A	2	22	7/30	0.007	0.18	0.020	0.51	0.160	4.06	30.0	45.0
POLYPROPYLENE INSULATION – UL STYLE 2717, UL STYLE 2835, CM(UL) c(UL) CMH											
C1353A**	2	22	7/30	0.010	0.25	0.028	0.71	0.208	5.028	25.0	53.5
SR-PVC INSULATION – UL STYLE 2464, CM(UL) c(UL) CMG											
C7106A	2	20	7/28	0.010	0.25	0.041	1.04	0.305	7.75	46.0	82.0

*A – Capacitance between conductors

*B – Capacitance between one conductor and other conductors connected to shield

**Individually shielded with overall shield

Color Code Chart

NO. OF PAIRS	COLOR
1	Black/Red
2	Green/White



Multi-Paired, Individually Shielded

CSA Type AWM I/II A/B, NEC/CEC Type CMG (CSA C/US)

Product Construction:

Conductor:

- 22 AWG fully annealed stranded tinned copper per ASTM B-33
- Twisted pairs

Insulation:

- Premium-grade, color-coded PVC
- Color code: See chart below

Shield:

- Individually shielded pairs
- 100% Flexfoil® aluminum/polyester, 25% overlap, foil facing out
- Stranded tinned copper drain wire

Jacket:

- PVC, gray
- Temperature range: -20°C to +105°C

Applications:

- Where total isolation of signal is required
- Computers
- Control circuits
- Industrial equipment
- Suggested voltage rating: 300 or 600 volts

Features:

- Excellent high-frequency properties
- Mechanical durability

Compliances:

- CSA Type AWM (105°C, 600V)
- CSA Certified CMG to harmonized standard UL444 and CSA (22.2 No. 2)
- NEC/CEC Type CMG (CSA: 105°C, 300V)
- RoHS Compliant Directive 2002/95/EC
- Designed to meet CSA 70,000 BTU Vertical Tray Flame Test
- Passes CSA FT4 Vertical Flame Test

Packaging:

- Please contact Customer Service for packaging and color options

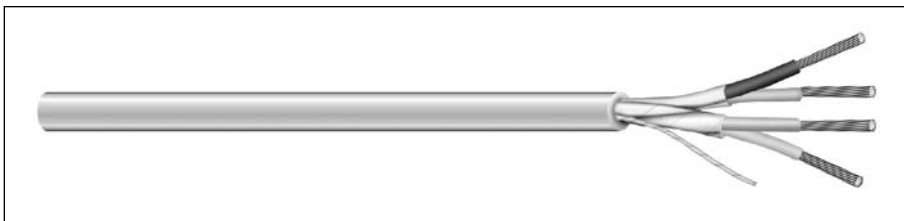

CATALOG NUMBER	NO. OF PAIRS	AWG SIZE	COND. STRAND	NOMINAL INSULATION THICKNESS		NOMINAL JACKET THICKNESS		NOMINAL O.D.		NOMINAL DCR Ω/kft		NOMINAL CAP* pF/ft	
				INCHES	mm	INCHES	mm	INCHES	mm	COND.	SHLD.	A	B
C4203A	2	22	7/30	0.007	0.18	0.020	0.51	0.160	4.06	16.6	7.2	67.0	121.0

*A – Capacitance between conductors

*B – Capacitance between one conductor and other conductors connected to shield

Color Code Chart

NO. OF PAIRS	COLOR
1	Black with Red
2	Green with White

Multi-Paired, Individually Shielded, Overall Shield

UL 2464, UL 2576, NEC Type CMR (UL) c(UL), CSA CMG

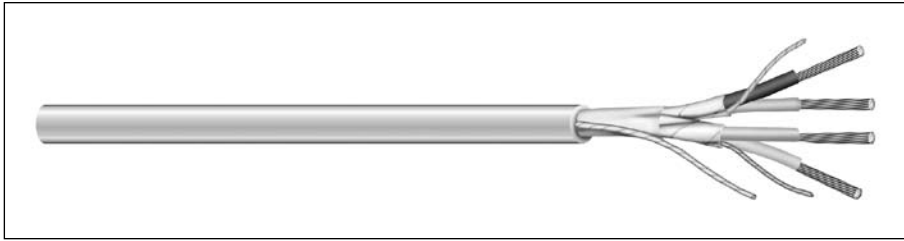

Product Construction:

Conductor:

- 22 AWG fully annealed stranded tinned copper per ASTM B-33
- Twisted pairs

Insulation:

- Premium-grade, color-coded S-R PVC per UL 1061
- Color code: See chart below

Shield:

- Individually shielded pairs plus an overall foil shield and drain wire
- 100% Flexfoil® aluminum/polyester, 25% overlap, foil facing in
- Stranded tinned copper drain wire

Jacket:

- PVC, beige
- Temperature range: -20°C to +80°C

Applications:

- Computer interconnections
- Data transmission
- Control circuits
- Industrial equipment control
- Suggested voltage rating: 300 volts

Features:

- Excellent high frequency properties
- Mechanical durability

Compliances:

- NEC Article 800 Type CMR (UL: 75°C)
- UL Style 2464 (UL: 80°C, 300V)
- UL Style 2576
- CSA CMG (CSA: 60°C)
- RoHS Compliant Directive 2002/95/EC
- Designed to meet UL 70,000 BTU Vertical Tray Flame Test
- Passes CSA CMG Flame Test

Packaging:

- Please contact Customer Service for packaging and color options

CATALOG NUMBER	NO. OF PAIRS	AWG SIZE	COND. STRAND	NOM. INSULATION THICKNESS		NOM. JACKET THICKNESS		NOMINAL O.D.		NOMINAL CAP.*	
				INCHES	mm	INCHES	mm	INCHES	mm	A	B
C1350A	2	22	7/30	0.010	0.25	0.035	0.889	0.175 x 0.280	4.45 x 7.11	40	71.5

*A – Capacitance between conductors

*B – Capacitance between one conductor and other conductors connected to shield

Color Code Chart

NO. OF PAIRS	COLOR
1	Black/White
2	Black/Yellow



Multi-Paired, Individually Foil Shielded

NEC Type CMP (UL) c(UL)

Product Construction:

Conductor:

- 22 AWG fully annealed stranded tinned copper per ASTM B-33

Insulation:

- Premium-grade, color-coded fluoropolymer
- Color code: See chart below

Shield:

- 100% Flexfoil® aluminum/polyester foil, each with 25% overlap, minimum
- Stranded tinned copper drain wire

Jacket:

- Fluoropolymer, red
- Temperature range: -20°C to +150°C
- Sequential footage marked to facilitate installation
- Includes ripcord

Applications:

- Point of sale systems
- Remote control circuits
- Process control and instrumentation
- Power-limited control circuits
- Suggested voltage rating: 300 volts

Compliances:

- NEC Article 800 (UL: 150°C, 300V)
- Designed to meet NFPA 262 and CSA FT-6 Steiner Tunnel Fire Tests for Plenum Applications

Features:

- Individually shielded pairs for excellent signal isolation
- Abrasion-, chemical- and water-resistant jacket

Packaging:

- Please contact Customer Service for packaging and color options

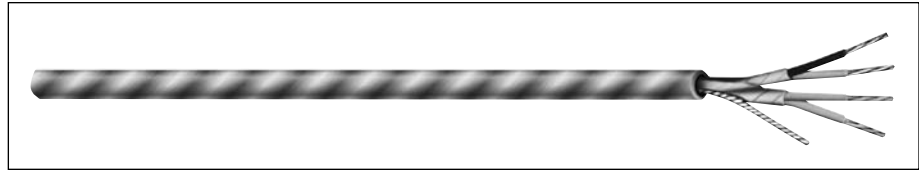

CATALOG NUMBER	NO. OF PAIRS	AWG SIZE	COND. STRAND	NOM. INSULATION THICKNESS		NOM. JACKET THICKNESS		NOMINAL O.D.		NOM. CAP:**	
				INCHES	mm	INCHES	mm	INCHES	mm	A	B
C3156*	2	22	7/30	0.006	0.15	0.010	0.25	0.147	3.73	35.0	63.0
C3157†	3	22	7/30	0.006	0.15	0.010	0.25	0.184	4.67	35.0	63.0

* Cabled on common axis to reduce diameter, foil out, common drain wire

** A – Capacitance between conductors

** B – Capacitance between one conductor and other conductors connected to shield

† 3 individually shielded pairs with separate drain wires

Color Code Chart

C3156	
NO. OF PAIRS	COLOR
1	Black paired with Red
2	White paired with Green

C3157	
NO. OF PAIRS	COLOR
1	Black paired with Red
2	Black paired with White
3	Black paired with Green

Multi-Paired, Individually Foil Shielded

NEC Type CMP (UL) c(UL)

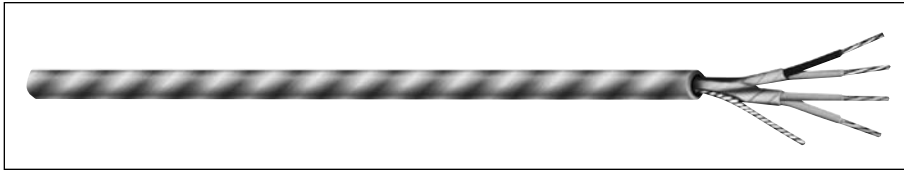

CATALOG NUMBER	NO. OF PAIRS	AWG SIZE	COND. STRAND	NOM. INSULATION THICKNESS		NOM. JACKET THICKNESS		NOMINAL O.D.		NOM. CAP.*	
				INCHES	mm	INCHES	mm	INCHES	mm	A	B
C8134	2	24	7/32	0.019	0.48	0.015	0.38	0.255	7.48	35.0	76.0
C8105	2	22	7/30	0.006	0.15	0.014	0.36	0.186	4.72	43.0	75.0
C8131	3	22	7/30	0.010	0.25	0.018	0.46	0.237	6.02	35.0	76.0
C8133	6	22	7/30	0.010	0.25	0.018	0.45	0.314	7.98	35.0	76.0

*A – Capacitance between conductors

*B – Capacitance between one conductor and other conductors connected to shield

Color Code Chart

C8105	
NO. OF PAIRS	COLOR
1	Black paired with Red
2	White paired with Green

C8131	
NO. OF PAIRS	COLOR
1	Black paired with Red
2	Black paired with White
3	Black paired with Green

C8133	
NO. OF PAIRS	COLOR
1	Black paired with Red
2	Black paired with White
3	Black paired with Green
4	Black paired with Blue
5	Black paired with Yellow
6	Black paired with Brown

C8134	
NO. OF PAIRS	COLOR
1	White/Blue paired with Blue/White
2	White/Orange paired with Orange/White

Product Construction:

Conductor:

- 24 thru 22 AWG fully annealed stranded tinned copper per ASTM B-33

Insulation:

- Premium-grade, color-coded FEP or foamed FEP
- Color code: See chart below

Pair Shield:

- 100% Flexfoil® aluminum/polyester foil, with 25% overlap, minimum
- Individually shielded pairs with stranded tinned copper drain wire

Jacket:

- Flexguard® PVC, natural
- Temperature range: -20°C to +75°C

Applications:

- Computer systems
- Remote control circuits
- Process control and instrumentation
- Suggested voltage rating: 300 volts

Compliances:

- NEC Article 800
- Designed to meet NFPA 262 and CSA FT-6 Steiner Tunnel Fire Tests for Plenum Applications

Features:

- Individually shielded pairs for excellent signal isolation
- Fire-retardant, low-smoke jacket

Packaging:

- Please contact Customer Service for packaging and color options



Designed to Meet
NFPA 262 and CSA FT-6
Steiner Tunnel Fire Tests
for Plenum Applications

Underwriters Laboratories Inc.



Multi-Paired, Individually Foil Shielded

NEC Type CMP (UL) c(UL)

Product Construction:

Conductor:

- 22 AWG fully annealed stranded tinned copper per ASTM B-33

Insulation:

- Premium-grade, color-coded FEP
- Color code: See chart below

Pair Shield:

- 100% Flexfoil® aluminum/polyester foil, with 25% overlap, minimum
- Individually shielded pairs with stranded tinned copper drain wire

Jacket:

- FEP, red or as requested
- Temperature range: -40°C to +200°C

Applications:

- Computer systems
- Remote control circuits
- Process control and instrumentation
- Suggested voltage rating: 300 volts

Compliances:

- NEC Article 800
- Designed to meet NFPA 262 and CSA FT-6 Steiner Tunnel Fire Tests for Plenum Applications

Features:

- Individually shielded pairs for excellent signal isolation
- Fire-retardant, low-smoke jacket

Packaging:

- Please contact Customer Service for packaging and color options

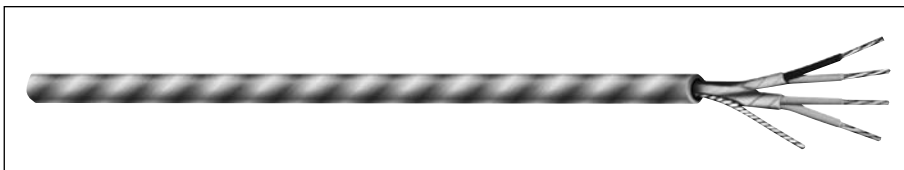

CATALOG NUMBER	NO. OF PAIRS	AWG SIZE	COND. STRAND	NOM. INSULATION THICKNESS		NOM. JACKET THICKNESS		NOMINAL O.D.		NOM. CAP.*	
				INCHES	mm	INCHES	mm	INCHES	mm	A	B
C8112	2	22	7/30	0.006	0.15	0.014	0.36	0.186	4.72	35.0	65.0
C8132	6	22	7/30	0.010	0.25	0.015	0.38	0.309	7.85	30.0	65.0

*A – Capacitance between conductors

*B – Capacitance between one conductor and other conductors connected to shield

Color Code Chart

C8112 NO. OF PAIRS	COLOR
1	Black paired with Red
2	White paired with Green

C8132 NO. OF PAIRS	COLOR
1	Black paired with Red
2	Black paired with White
3	Black paired with Green
4	Black paired with Blue
5	Black paired with Yellow
6	Black paired with Brown

Multi-Paired, Individually Foil Shielded

NEC Type CMP (UL) c(UL)

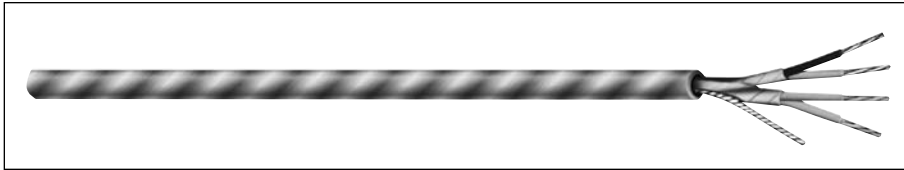

CATALOG NUMBER	NO. OF PAIRS	AWG SIZE	COND. STRAND	NOM. INSULATION THICKNESS		NOM. JACKET THICKNESS		NOMINAL O.D.		NOM. CAP.*	
				INCHES	mm	INCHES	mm	INCHES	mm	A	B
C8128	2	24	7/32	0.019	0.48	0.018	0.46	0.261	6.63	12.5	22.0

*A – Capacitance between conductors

*B – Capacitance between one conductor and other conductors connected to shield

Color Code Chart

NO. OF PAIRS	COLOR
1	White/Blue paired with Blue/White
2	White/Orange paired with Orange/White

Product Construction:

Conductor:

- 24 AWG fully annealed stranded tinned copper per ASTM B-33

Insulation:

- Premium-grade, color-coded foam FEP
- Color code: See chart below

Pair Shield:

- 100% Flexfoil® aluminum/polyester foil with 25% overlap, minimum
- Individually shielded pairs with stranded tinned copper drain wire

Jacket:

- PVDF, gray or as requested
- Temperature range: -40°C to +150°C

Applications:

- Computer systems
- Remote control circuits
- Process control and instrumentation
- Suggested voltage rating: 300 volts

Compliances:

- NEC Article 800
- Designed to meet NFPA 262 and CSA FT-6 Steiner Tunnel Fire Tests for Plenum Applications

Features:

- Individually shielded pairs for excellent signal isolation
- Fire-retardant, low-smoke jacket

Packaging:

- Please contact Customer Service for packaging and color options



Designed to Meet
NFPA 262 and CSA FT-6
Steiner Tunnel Fire Tests
for Plenum Applications

Underwriters Laboratories Inc.



Power-Limited Tray Cable, Individually Shielded

UL 2464, NEC Type PLTC AND CSA CMG

Product Construction:

Conductor:

- 22 or 18 AWG fully annealed stranded tinned copper per ASTM B-33
- Twisted pairs

Insulation:

- Premium-grade, color-coded PVC
- Color code: Each pair black and red, numbered at one-inch intervals

Shield:

- Pairs are 100% individually shielded with Flexfoil® aluminum/polyester, foil facing in
- Stranded tinned copper drain wire each pair

Jacket:

- PVC, gray
- Temperature range: -20°C to +105°C

Applications:

- Power-limited circuits
- Intercom systems
- Business machines
- Cash registers
- Computer interconnects
- Suitably marked for appropriate tray cable installations
- Burglar alarms
- Suggested voltage rating: 300 volts

Features:

- Superior temperature characteristics
- Robust, highly durable
- Sunlight-resistant jacket

Compliances:

- NEC Article 725 Power-Limited Tray Cable (UL: 105°C, 300V)
- UL Style 2464 (UL: 80°C)
- CSA CMG (CSA: 60°C)
- RoHS Compliant Directive 2002/95/EC
- Designed to meet UL 70,000 BTU Vertical Tray Flame Test
- Passes CSA CMG Flame Test

Packaging:

- Please contact Customer Service for packaging and color options

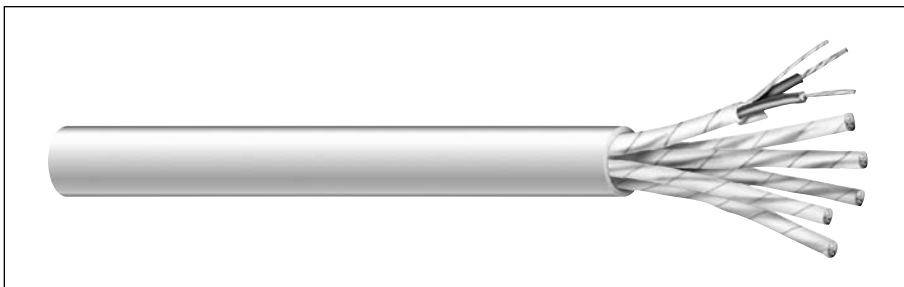

CATALOG NUMBER	NO. OF PAIRS	AWG SIZE	COND. STRAND	NOM. INSULATION THICKNESS		NOM. JACKET THICKNESS		NOMINAL O.D.		NOMINAL CAP.* pF/ft	
				INCHES	mm	INCHES	mm	INCHES	mm	A	B
C0570A	2	22	7/30	0.016	0.41	0.042	1.07	0.327	8.31	38.5	69.5
C0571A	3	22	7/30	0.015	0.41	0.042	1.07	0.345	8.76	38.5	69.5
C0572A	4	22	7/30	0.015	0.41	0.042	1.07	0.378	9.60	38.5	69.5
C0573A	6	22	7/30	0.015	0.41	0.053	1.35	0.469	11.91	38.5	69.5
C0574A	9	22	7/30	0.015	0.41	0.053	1.35	0.542	13.77	38.5	69.5
C0575A	11	22	7/30	0.015	0.41	0.053	1.35	0.589	14.96	38.5	69.5
C0584A	2	18	16/30	0.016	0.41	0.042	1.07	0.380	9.65	50.5	91.0
C0585A	3	18	16/30	0.016	0.41	0.053	1.35	0.437	11.10	50.5	91.0
C0586A	4	18	16/30	0.016	0.41	0.053	1.35	0.478	12.14	50.5	91.0
C0587A	6	18	16/30	0.016	0.41	0.053	1.35	0.566	14.38	50.5	91.0
C0588A	9	18	16/30	0.016	0.41	0.063	1.60	0.679	17.25	50.5	91.0
C0589A	11	18	16/30	0.016	0.41	0.063	1.60	0.738	18.75	50.5	91.0
C0590A	15	18	16/30	0.015	0.38	0.063	1.60	0.845	21.46	50.5	91.0

*A – Capacitance between conductors

*B – Capacitance between one conductor and other conductors connected to shield

Color Code Chart

NO. OF PAIRS	COLOR
1 thru 15	Black Red

Each pair marked and numbered

Power-Limited Tray Cable, Foil Shield or Foil/Braid Shield

UL 2464, NEC Type PLTC/CM, CSA CMG



Product Construction:

Conductor:

- 22 or 18 AWG fully annealed stranded tinned copper per ASTM B-33
- Twisted pairs

Insulation:

- Premium-grade, color-coded PVC or FMPE
- Color code: See chart below

Shield:

- 100% Flexfoil® aluminum/polyester, 25% overlap, foil facing out
- Stranded tinned copper drain wire
- 65% tinned copper braid (C7101A, C7103A and C7107A only)

Jacket:

- PVC, gray or black
- Temperature range: -20°C to +60°C or +105°C

Applications:

- Power-limited circuits
- Intercom systems
- Business machines
- Computer interconnects
- Suitably marked for appropriate tray cable installations
- Petrochemical control systems
- Burglar alarms
- Suggested voltage rating: 300 volts

Features:

- Superior temperature characteristics
- Robust, highly durable
- Sunlight-resistant jacket

Compliances:

- NEC Article 725 Power-Limited Tray Cable (UL: 105°C or 60°C, 300V)
- NEC Article 800 Communications Cable (UL: 105°C or 60°C, 300V)
- †UL Style 2464 (UL: 80°C, 300V)
- CSA CMG (CSA: 60°C) or CM c(UL)
- RoHS Compliant Directive 2002/95/EC
- Designed to meet UL 70,000 BTU Vertical Tray Flame Test
- Passes CSA CMG Flame Test

Packaging:

- Please contact Customer Service for packaging and color options

† UL Style 2464 only available on PVC insulation constructions

CATALOG NUMBER	NO. OF PAIRS	AWG SIZE	COND. STRAND	NOM. INSULATION THICKNESS		NOM. JACKET THICKNESS		NOMINAL O.D.		NOMINAL CAP.*	
				INCHES	mm	INCHES	mm	INCHES	mm	A	B

PVC INSULATION – UL STYLE 2464, NEC TYPE PLT/CM, CSA CMG, 105°C

C0550A	2	22	7/.0096	0.015	0.38	0.042	1.07	0.294	7.47	32.0	57.0
C0551A	3	22	7/.0096	0.015	0.38	0.042	1.07	0.309	7.85	29.0	52.2
C0552A	4	22	7/.0096	0.015	0.38	0.042	1.07	0.337	8.56	29.0	52.2
C0553A	6	22	7/.0096	0.015	0.38	0.042	1.35	0.418	10.62	26.5	47.7
C0554A	9	22	7/.0096	0.015	0.38	0.042	1.35	0.480	12.19	26.5	47.7
C0555A	11	22	7/30	0.015	0.38	0.053	1.35	0.520	13.21	27.0	48.5
C0556A	15	22	7/30	0.015	0.38	0.053	1.35	0.592	15.04	27.0	48.5
C0560A	2	18	16/30	0.016	0.41	0.042	1.07	0.314	7.98	40.0	72.0
C0561A	3	18	16/30	0.016	0.41	0.042	1.35	0.403	10.24	33.5	60.3
C0562A	4	18	16/30	0.016	0.41	0.042	1.35	0.440	11.18	33.5	60.3
C0563A	6	18	16/30	0.016	0.41	0.042	1.35	0.519	13.18	30.5	54.9
C0564A	9	18	16/30	0.016	0.41	0.042	1.60	0.622	15.80	30.5	54.9
C0566A	15	18	16/30	0.016	0.41	0.042	1.60	0.622	15.80	30.5	54.9

*A – Capacitance between conductors

*B – Capacitance between one conductor and other conductors connected to shield

Color Code Chart

NO. OF PAIRS	COLOR
1 thru 9	Black/Red

Each pair marked and numbered

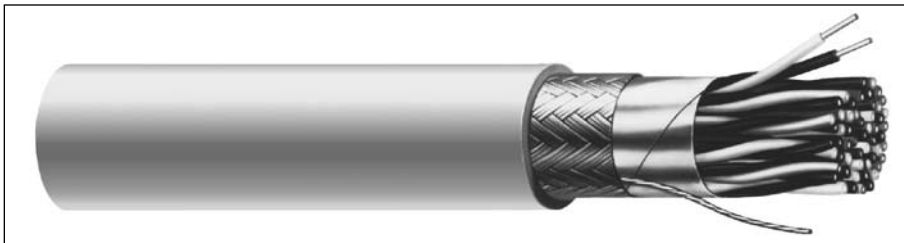

LO-CAP® DATACOM COLOR CODE WITH 65% TINNED COPPER BRAID

CATALOG NUMBER	NO. OF PAIRS	AWG SIZE	COND. STRAND	NOM. INSULATION THICKNESS		NOM. JACKET THICKNESS		NOMINAL O.D.		NOMINAL CAP.*	
				INCHES	mm	INCHES	mm	INCHES	mm	A	B

FOAMED POLYETHYLENE INSULATION – NEC TYPE PLTC/CM, CEC CM c(UL), 60°C

C7112A	1	22	7/.0096	0.024	0.61	0.037	0.94	0.261	6.63	11.5	20.5
C7114A	2	22	7/.0096	0.017	0.43	0.042	1.07	0.343	8.71	11.0	19.6
C7116A	3	22	7/.0096	0.015	0.38	0.042	1.07	0.344	8.74	11.0	19.6

*A – Capacitance between conductors

*B – Capacitance between one conductor and other conductors connected to shield

Color Code Chart

NO. OF PAIRS	COLOR
1	White/Blue Stripe and Blue/White Stripe
2	White/Orange Stripe and Orange/White Stripe
3	White/Green Stripe and Green/White Stripe



Computer Cable

4

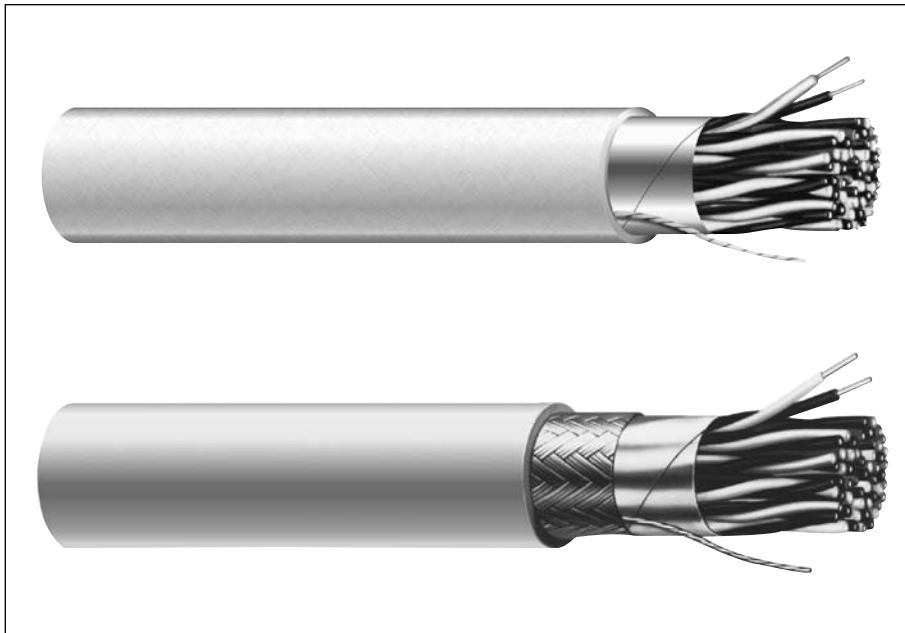

General Cable manufactures a comprehensive line of computer cables.

This complete line of paired and unpaired, shielded computer cables—which are UL and CSA listed—are used primarily for the internal or external interconnection of electronic equipment and computers. Applications include data transmission, CAD/CAM, telemetry, data displays, computer print-out, credit verification systems and similar applications.

General Cable also offers a variety of put-ups for computer cables to meet your individual requirements.

Our products are manufactured to meet the latest UL, CSA and NEC requirements and approvals.

Index	Page
Multi-Conductor, Foil Shield	68-69
Multi-Conductor, Foil/Braid Shield	70-71
Multi-Conductor, Foil/Braid Shield, Lo-Cap®	72
Multi-Paired, Foil Shield	73
Multi-Paired, Foil Shield, Lo-Cap®	74
Multi-Paired, Foil/Braid Shield	75
Multi-Paired, Foil/Braid Shield, Lo-Cap®	76-79
Multi-Paired, Individually Foil Shielded	80-82
Multi-Paired, Individually Foil Shielded, Lo-Cap®	83
Multi-Paired, Individually Foil/Braid Shielded, Lo-Cap®	84

Multi-Conductor, Foil Shield

UL 2464, NEC Type CMR (UL) c(UL), CSA CMG

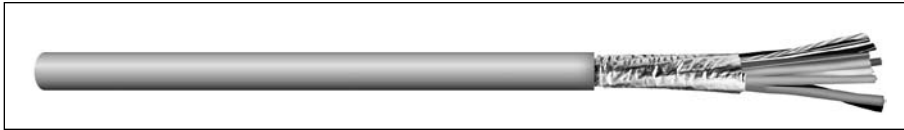

Product Construction:

Conductor:

- 24 AWG fully annealed stranded tinned copper per ASTM B-33

Insulation:

- Premium-grade, color-coded S-R PVC per UL 1061
- Color code: See charts below

Shield:

- 100% Flexfoil® aluminum/polyester with 25% overlap, foil facing out
- Stranded tinned copper drain wire

Jacket:

- PVC, gray
- Temperature range: -20°C to +80°C

Applications:

- Computer interconnections
- Data transmission
- Control circuits
- Industrial equipment control
- Suitable for EIA RS-232 applications
- Suggested voltage rating: 300 volts

Compliances:

- NEC Article 800 Type CMR (UL: 75°C)
- UL Style 2464 (UL: 80°C, 300V)
- CSA CMG (CSA: 60°C)
- RoHS Compliant Directive 2002/95/EC
- Designed to meet UL 70,000 BTU Vertical Tray Flame Test
- Passes CSA CMG Flame Test

Packaging:

- Please contact Customer Service for packaging and color options

CATALOG NUMBER	NO. OF COND.	AWG SIZE	COND. STRAND	NOMINAL INSULATION THICKNESS		NOMINAL JACKET THICKNESS		NOMINAL O.D.		NOMINAL DCR Ω/kft @20°C		NOMINAL CAP.* pF/ft	
				INCHES	mm	INCHES	mm	INCHES	mm	COND.	SHLD.	A	B
C0740A	2	24	7/32	0.010	0.25	0.032	0.81	0.157	3.99	26.0	7.2	36.0	64.0
C0741A	3	24	7/32	0.010	0.25	0.032	0.81	0.164	4.17	26.0	7.2	33.0	59.0
C0742A	4	24	7/32	0.010	0.25	0.032	0.81	0.175	4.45	26.0	7.2	33.0	59.0
C0753A	5	24	7/32	0.010	0.25	0.032	0.81	0.188	4.78	26.0	7.2	33.0	59.0
C0743A	6	24	7/32	0.010	0.25	0.032	0.81	0.201	5.11	26.0	7.2	30.0	55.0
C0754A	7	24	7/32	0.010	0.25	0.032	0.81	0.201	5.11	26.0	7.2	30.0	55.0
C0744A	8	24	7/32	0.010	0.25	0.032	0.81	0.215	5.46	26.0	7.2	30.0	55.0
C0755A	9	24	7/32	0.010	0.25	0.032	0.81	0.228	5.79	26.0	7.2	30.0	55.0
C0745A	10	24	7/32	0.010	0.25	0.032	0.81	0.245	6.22	26.0	7.2	30.0	55.0

*A – Capacitance between conductors

*B – Capacitance between one conductor and other conductors connected to shield

Color Code Chart 1 - For cables up to and including 10 conductors

NO. OF COND.	COLOR	NO. OF COND.	COLOR
1	Black	6	Light Blue
2	White	7	Orange
3	Red	8	Yellow
4	Light Green	9	Violet
5	Light Brown	10	Gray

CATALOG NUMBER	NO. OF COND.	AWG SIZE	COND. STRAND	NOMINAL INSULATION THICKNESS		NOMINAL JACKET THICKNESS		NOMINAL O.D.		NOMINAL DCR Ω/kft @20°C		NOMINAL CAP.* pF/ft	
				INCHES	mm	INCHES	mm	INCHES	mm	COND.	SHLD.	A	B
C0746A	15	24	7/32	0.010	0.25	0.032	0.81	0.276	7.01	26.0	7.2	30.0	55.0
C0747A	20	24	7/32	0.010	0.25	0.032	0.81	0.303	7.70	26.0	7.2	30.0	55.0
C0748A	25	24	7/32	0.010	0.25	0.032	0.81	0.333	8.46	26.0	7.2	30.0	55.0
C0749A	30	24	7/32	0.010	0.25	0.032	0.81	0.351	8.92	26.0	7.2	30.0	55.0
C0750A	40	24	7/32	0.010	0.25	0.032	0.81	0.391	9.93	26.0	7.2	30.0	55.0
C0751A	50	24	7/32	0.010	0.25	0.032	0.81	0.439	11.15	26.0	7.2	30.0	55.0

*A – Capacitance between conductors

*B – Capacitance between one conductor and other conductors connected to shield

Color Code Chart 2 Per ICEA - For cables of 15 thru 50 conductors

NO. OF COND.	COLOR	NO. OF COND.	COLOR	NO. OF COND.	COLOR	NO. OF COND.	COLOR
1	Black	14	Light Green/White	27	Light Blue/Black/White	39	White/Black/Green
2	White	15	Light Blue/White	28	Black/Red/Green	40	Red/White/Green
3	Red	16	Black/Red	29	White/Red/Green	41	Light Green/White/Blue
4	Light Green	17	White/Red	30	Red/Black/Green	42	Orange/Red/Green
5	Orange	18	Orange/Red	31	Light Green/Black/Orange	43	Light Blue/Red/Green
6	Light Blue	19	Light Blue/Red	32	Orange/Black/Green	44	Black/White/Blue
7	White/Black	20	Red/Green	33	Light Blue/White/Orange	45	White/Black/Blue
8	Red/Black	21	Orange/Green	34	Black/White/Orange	46	Red/White/Blue
9	Light Green/Black	22	Black/White/Red	35	White/Red/Orange	47	Light Green/Orange/Red
10	Orange/Black	23	White/Black/Red	36	Orange/White/Blue	48	Orange/Red/Blue
11	Light Blue/Black	24	Red/Black/White	37	White/Red/Blue	49	Light Blue/Red/Orange
12	Black/White	25	Light Green/Black/White	38	Black/White/Green	50	Black/Orange/Red
13	Red/White	26	Orange/Black/White				



Multi-Conductor, Foil Shield

UL 2464, NEC Type CM (UL) c(UL) or CMR (UL) c(UL), CSA CMG

Product Construction:

Conductor:

- 22 or 20 AWG fully annealed stranded tinned copper per ASTM B-33

Insulation:

- Premium-grade, color-coded S-R PVC or PVC
- Color code: See chart below

Shield:

- 100% Flexfoil® aluminum/polyester with 25% overlap, minimum, foil facing out
- Stranded tinned copper drain wire

Jacket:

- PVC, gray
- Temperature range: -20°C to +80°C

Applications:

- Computer interconnections
- Data transmission
- Control circuits
- Industrial equipment control
- Suitable for EIA RS-232 applications
- Suggested voltage rating: 300 volts

Compliances:

- NEC Article 800 Type CM - 20 or 22 AWG (UL: 75°C)
- NEC Article 800 Type CMR - 20 or 22 AWG (UL: 75°C)
- UL Style 2464 (UL: 80°C, 300V)
- CSA CMG (CSA: 60°C)
- RoHS Compliant Directive 2002/95/EC
- Designed to meet UL 70,000 BTU Vertical Tray Flame Test
- Passes CSA CMG Flame Test

Packaging:

- Please contact Customer Service for packaging and color options

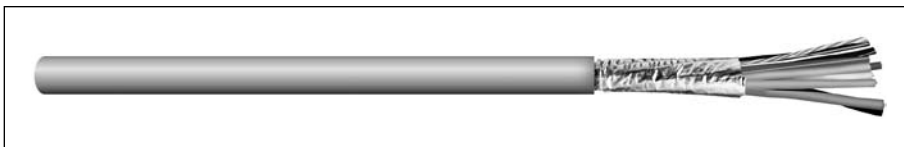

CATALOG NUMBER	NO. OF COND.	AWG SIZE	COND. STRAND	NOMINAL INSULATION THICKNESS		NOMINAL JACKET THICKNESS		NOMINAL O.D.		NOMINAL DCR @20°C		NOMINAL CAP.*	
				INCHES	mm	INCHES	mm	INCHES	mm	COND.	SHLD.	A	B

S-R PVC – CMR (UL) c(UL)

C0760A	2	22	7/30	0.010	0.25	0.032	0.81	0.169	4.29	16.5	6.3	36.0	65.0
C0761A	3	22	7/30	0.010	0.25	0.032	0.81	0.177	4.50	16.5	6.3	36.0	65.0
C0762A	4	22	7/30	0.010	0.25	0.032	0.81	0.190	4.83	16.5	6.3	36.0	65.0
C0763A	6	22	7/30	0.010	0.25	0.032	0.81	0.219	5.56	16.5	6.3	34.0	61.0
C0764A	8	22	7/30	0.010	0.25	0.032	0.81	0.235	5.97	16.5	6.3	34.0	61.0
C0765A	10	22	7/30	0.010	0.25	0.032	0.81	0.269	6.83	16.5	6.3	34.0	61.0
C0766A	15	22	7/30	0.010	0.25	0.032	0.81	0.304	7.72	16.5	6.3	34.0	61.0
C0767A	20	22	7/30	0.010	0.25	0.032	0.81	0.335	8.51	16.5	6.3	34.0	61.0
C0768A	25	22	7/30	0.010	0.25	0.032	0.81	0.369	9.37	16.5	6.3	34.0	61.0

PVC – CM (UL) c(UL)

C0780A	2	20	7/28	0.016	0.41	0.032	0.81	0.207	5.26	11.0	6.3	39.0	70.0
C0781A	3	20	7/28	0.016	0.41	0.032	0.81	0.217	5.51	11.0	6.3	39.0	70.0
C0782A	4	20	7/28	0.016	0.41	0.032	0.81	0.236	5.99	11.0	6.3	39.0	70.0
C0783A	6	20	7/28	0.016	0.41	0.032	0.81	0.276	7.01	11.0	6.3	37.0	66.0
C0784A	8	20	7/28	0.016	0.41	0.032	0.81	0.297	7.54	11.0	6.3	37.0	66.0
C0785A	10	20	7/28	0.016	0.41	0.032	0.81	0.345	8.76	11.0	6.3	37.0	66.0
C0786A	15	20	7/28	0.016	0.41	0.032	0.81	0.393	9.98	11.0	6.3	37.0	66.0
C0787A	20	20	7/28	0.016	0.41	0.032	0.81	0.435	11.05	11.0	6.3	37.0	66.0
C0788A	25	20	7/28	0.016	0.41	0.032	0.81	0.483	12.27	11.0	6.3	40.0	72.0

*A – Capacitance between conductors

*B – Capacitance between one conductor and other conductors connected to shield

Color Code Chart

NO. OF COND.	COLOR	NO. OF COND.	COLOR	NO. OF COND.	COLOR
1	Black	10	Orange/Black	19	Blue/Red
2	White	11	Blue/Black	20	Red/Green
3	Red	12	Black/White	21	Orange/Green
4	Green	13	Red/White	22	Black/White/Red
5	Orange	14	Green/White	23	White/Black/Red
6	Blue	15	Blue/White	24	Red/Black/White
7	White/Black	16	Black/Red	25	Green/Black/White
8	Red/Black	17	White/Red		
9	Green/Black	18	Orange/Red		

Multi-Conductor, Foil/Braid Shield

UL 2464, NEC Type CL2 (UL) or CM (UL) c(UL), CSA CMG

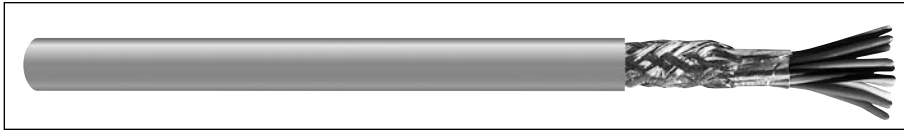

Product Construction:

Conductor:

- 28 and 24 AWG fully annealed stranded tinned copper per ASTM B-33

Insulation:

- Premium-grade, color-coded S-R PVC per UL 1061
- Color code: See charts below

Shield:

- 100% Flexfoil® aluminum/polyester with 25% overlap, minimum, foil facing out
- Stranded tinned copper drain wire (28 AWG only)
- 65% tinned copper braid

Jacket:

- PVC, gray
- Temperature range: -20°C to +80°C

Applications:

- Computers
- Industrial equipment
- Data transmission
- Control circuits
- Suitable for EIA RS-232 applications
- Suggested voltage rating: 300 volts

Features:

- Braid shield provides good flexibility
- Superior shielding where noise rejection is critical
- Assists system designers in meeting FCC Docket 20780 demands

Compliances:

- NEC Article 725 Type CL2 - 28 AWG (UL: 75°C)
- NEC Article 800 Type CM - 24 AWG (UL: 75°C)
- UL Style 2464 (UL: 80°C, 300V)
- CSA CMG (CSA: 60°C)
- RoHS Compliant Directive 2002/95/EC
- Designed to meet UL 70,000 BTU Vertical Tray Flame Test
- Passes CSA CMG Flame Test

Packaging:

- Please contact Customer Service for packaging and color options

CATALOG NUMBER	NO. OF COND.	AWG SIZE	COND. STRAND	NOMINAL INSULATION THICKNESS		NOMINAL JACKET THICKNESS		NOMINAL O.D.		NOMINAL DCR @20°C		NOMINAL CAP**	
				INCHES	mm	INCHES	mm	INCHES	mm	COND.	SHLD.	A	B

CL2, CMG, UL 2464

C0939A*	3	28	7/36	0.010	0.25	0.032	0.81	0.166	4.22	67.5	5.0	26.0	47.0
C0940A*	4	28	7/36	0.010	0.25	0.032	0.81	0.176	4.47	67.5	5.0	26.0	47.0
C0941A*	5	28	7/36	0.010	0.25	0.032	0.81	0.186	4.72	67.5	5.0	26.0	47.0
C0942A*	6	28	7/36	0.010	0.25	0.032	0.81	0.196	4.98	67.5	5.0	25.0	44.0
C0943A*	7	28	7/36	0.010	0.25	0.032	0.81	0.196	4.98	67.5	5.0	25.0	44.0
C0944A*	8	28	7/36	0.010	0.25	0.032	0.81	0.207	5.26	67.5	5.0	25.0	44.0
C0945A*	9	28	7/36	0.010	0.25	0.032	0.81	0.217	5.51	67.5	5.0	20.0	36.0
C0946A*	10	28	7/36	0.010	0.25	0.032	0.81	0.231	5.87	67.5	5.0	20.0	36.0
C0947A	15	28	7/36	0.010	0.25	0.032	0.81	0.256	6.50	67.5	5.0	20.0	36.0
C0948A	25	28	7/36	0.010	0.25	0.032	0.81	0.301	7.65	67.5	5.0	20.0	36.0

CM, CMG, UL 2464

C0951A	3	24	7/32	0.010	0.25	0.032	0.81	0.186	4.72	25.7	5.3	33.0	59.0
C0952A	4	24	7/32	0.010	0.25	0.032	0.81	0.197	5.00	25.7	5.5	33.0	59.0
C0953A	5	24	7/32	0.010	0.25	0.032	0.81	0.210	5.33	25.7	4.4	33.0	59.0
C0954A	6	24	7/32	0.010	0.25	0.032	0.81	0.223	5.66	25.7	4.6	30.0	55.0
C0955A	7	24	7/32	0.010	0.25	0.032	0.81	0.223	5.66	25.7	4.6	30.0	55.0
C0956A	8	24	7/32	0.010	0.25	0.032	0.81	0.237	6.02	25.7	3.8	30.0	55.0
C0957A	9	24	7/32	0.010	0.25	0.032	0.81	0.250	6.35	25.7	3.9	30.0	55.0
C0958A	10	24	7/32	0.010	0.25	0.032	0.81	0.267	6.78	25.7	4.2	30.0	55.0
C0959A	15	24	7/32	0.010	0.25	0.032	0.81	0.298	7.57	25.7	3.6	30.0	55.0
C0960A	20	24	7/32	0.010	0.25	0.032	0.81	0.325	8.26	25.7	4.5	30.0	55.0
C0961A	25	24	7/32	0.010	0.25	0.032	0.81	0.355	9.02	25.7	3.5	30.0	55.0

*Color Code Chart 1. Remaining items Color Code Chart 2

**A - Capacitance between conductors

**B - Capacitance between one conductor and other conductors connected to shield

Color Code Chart 1

NO. OF COND.	COLOR	NO. OF COND.	COLOR
1	Black	6	Light Blue
2	White	7	Orange
3	Red	8	Yellow
4	Light Green	9	Violet
5	Light Brown	10	Gray

Color Code Chart 2 Per ICEA

NO. OF COND.	COLOR	NO. OF COND.	COLOR	NO. OF COND.	COLOR
1	Black	10	Orange/Black	19	Light Blue/Red
2	White	11	Light Blue/Black	20	Red/Green
3	Red	12	Black/White	21	Orange/Green
4	Light Green	13	Red/White	22	Black/White/Red
5	Orange	14	Light Green/White	23	White/Black/Red
6	Light Blue	15	Light Blue/White	24	Red/Black/White
7	White/Black	16	Black/Red	25	Light Green/Black/White
8	Red/Black	17	White/Red		
9	Light Green/Black	18	Orange/Red		



Multi-Conductor, Foil/Braid Shield

UL 2464, NEC Type CMR (UL) c(UL), CSA CMG

Product Construction:

Conductor:

- 22 AWG fully annealed stranded tinned copper per ASTM B-33

Insulation:

- Premium-grade, color-coded S-R PVC per UL 1061
- Color code: See chart below

Shield:

- 100% Flexfoil® aluminum/polyester with 25% overlap, minimum, foil facing out
- 65% tinned copper braid

Jacket:

- PVC, gray
- Temperature range: -20°C to +80°C

Applications:

- Computers
- Industrial equipment
- Data transmission
- Control circuits
- Suitable for EIA RS-232 applications
- Suggested voltage rating: 300 volts

Features:

- Braid shield provides good flexibility
- Superior shielding where noise rejection is critical
- Assists system designers in meeting FCC Docket 20780 demands

Compliances:

- NEC Article 800 Type CMR (UL: 75°C)
- UL Style 2464 (UL: 80°C, 300V)
- CSA CMG (CSA: 60°C)
- RoHS Compliant Directive 2002/95/EC
- Designed to meet UL 70,000 BTU Vertical Tray Flame Test
- Passes CSA CMG Flame Test

Packaging:

- Please contact Customer Service for packaging and color options

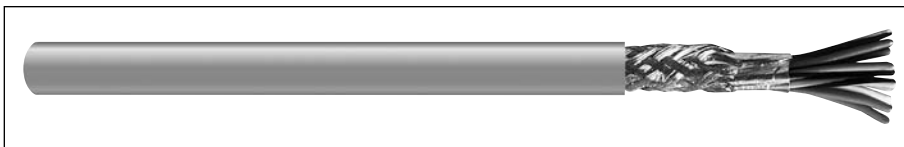

CATALOG NUMBER	NO. OF COND.	AWG SIZE	COND. STRAND	NOMINAL INSULATION THICKNESS		NOMINAL JACKET THICKNESS		NOMINAL O.D.		NOMINAL DCR Ω /kft @20°C		NOMINAL CAP.* pF/ft	
				INCHES	mm	INCHES	mm	INCHES	mm	COND.	SHLD.	A	B
C0971A	3	22	7/30	0.010	0.25	0.032	0.81	0.199	5.05	16.6	5.6	36.0	66.0
C0972A	4	22	7/30	0.010	0.25	0.032	0.81	0.212	5.38	16.6	4.4	36.0	66.0
C0973A	5	22	7/30	0.010	0.25	0.032	0.81	0.226	5.74	16.6	4.7	36.0	66.0
C0974A	6	22	7/30	0.010	0.25	0.032	0.81	0.241	6.12	16.6	3.8	34.0	60.0
C0975A	7	22	7/30	0.010	0.25	0.032	0.81	0.241	6.12	16.6	6.2	34.0	60.0
C0976A	8	22	7/30	0.010	0.25	0.032	0.81	0.257	6.53	16.6	4.0	34.0	60.0
C0977A	9	22	7/30	0.010	0.25	0.032	0.81	0.272	6.91	16.6	3.4	34.0	60.0
C0978A	10	22	7/30	0.010	0.25	0.032	0.81	0.291	7.39	16.6	3.6	34.0	60.0
C0979A	15	22	7/30	0.010	0.25	0.032	0.81	0.326	8.28	16.6	3.6	34.0	60.0
C0980A	20	22	7/30	0.010	0.25	0.032	0.81	0.357	9.07	16.6	3.9	34.0	60.0
C0981A	25	22	7/30	0.010	0.25	0.032	0.81	0.391	9.93	16.6	2.7	34.0	60.0

*A – Capacitance between conductors

*B – Capacitance between one conductor and other conductors connected to shield

Color Code Chart Per ICEA

NO. OF COND.	COLOR	NO. OF COND.	COLOR	NO. OF COND.	COLOR
1	Black	10	Orange/Black	19	Light Blue/Red
2	White	11	Light Blue/Black	20	Red/Green
3	Red	12	Black/White	21	Orange/Green
4	Light Green	13	Red/White	22	Black/White/Red
5	Orange	14	Light Green/White	23	White/Black/Red
6	Light Blue	15	Light Blue/White	24	Red/Black/White
7	White/Black	16	Black/Red	25	Light Green/Black/White
8	Red/Black	17	White/Red		
9	Light Green/Black	18	Orange/Red		

Multi-Conductor, Foil/Braid Shield, Lo-Cap®

UL 2919, NEC Type CL2 or CM (UL) c(UL) CMH, CSA CMH

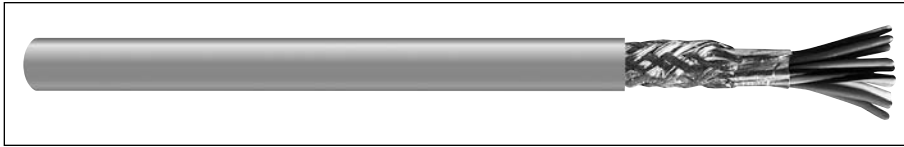

CATALOG NUMBER	NO. OF COND.	NOM. INSULATION THICKNESS		NOM. JACKET THICKNESS		NOMINAL O.D.		NOMINAL DCR Ω/kft		NOMINAL CAP.* pF/ft	
		INCHES	mm	INCHES	mm	INCHES	mm	COND.	SHLD.	A	B
28 AWG (7/36): CL2, CSA CMH											
C0530A	3	0.016	0.41	0.032	0.81	0.192	4.88	64.9	7.8	9.5	17.0
C0531A	4	0.016	0.41	0.032	0.81	0.205	5.21	64.9	5.9	9.5	17.0
C0532A	5	0.016	0.41	0.032	0.81	0.218	5.54	64.9	5.9	9.5	17.0
C0533A	6	0.016	0.41	0.032	0.81	0.232	5.89	64.9	6.2	9.0	16.0
C0534A	7	0.016	0.41	0.032	0.81	0.232	5.89	64.9	6.2	9.0	16.0
C0535A	8	0.016	0.41	0.032	0.81	0.247	6.27	64.9	4.8	9.0	16.0
C0536A	9	0.016	0.41	0.032	0.81	0.261	6.63	64.9	4.9	9.0	16.0
C0537A	10	0.016	0.41	0.032	0.81	0.279	7.09	64.9	5.2	9.0	16.0
C0538A	15	0.016	0.41	0.032	0.81	0.312	7.92	64.9	4.2	9.0	16.0

24 AWG (7/32): CM (UL) c(UL) CMH, AWM Style 2919											
C0680A	3	0.016	0.41	0.032	0.81	0.211	5.36	25.7	3.8	11.9	21.5
C0681A	4	0.016	0.41	0.032	0.81	0.227	5.77	25.7	3.8	11.9	21.5
C0682A	5	0.016	0.41	0.032	0.81	0.242	6.15	25.7	3.8	11.9	21.5
C0683A	6	0.016	0.41	0.032	0.81	0.259	6.58	25.7	3.2	11.2	20.2
C0684A	7	0.016	0.41	0.032	0.81	0.259	6.58	25.7	3.2	11.2	20.2
C0685A	8	0.016	0.41	0.032	0.81	0.276	7.01	25.7	3.2	11.2	20.2
C0686A	9	0.016	0.41	0.032	0.81	0.293	7.44	25.7	3.6	11.2	20.2
C0687A	10	0.016	0.41	0.032	0.81	0.315	8.00	25.7	3.6	11.2	20.2
C0688A	15	0.016	0.41	0.032	0.81	0.354	8.99	25.7	3.6	11.2	20.2

*A – Capacitance between conductors
 *B – Capacitance between one conductor and other conductors connected to shield
 Vp = 78%
 Impedance: ≈100 Ω

Color Code Chart 1 - For cables up to and including 10 conductors

NO. OF COND.	COLOR	NO. OF COND.	COLOR
1	Black	6	Light Blue
2	White	7	Orange
3	Red	8	Yellow
4	Light Green	9	Violet
5	Brown	10	Gray

Color Code Chart 2 Per ICEA - For cables up to 15 conductors

NO. OF COND.	COLOR	NO. OF COND.	COLOR
1	Black	10	Orange/Black
2	White	11	Light Blue/Black
3	Red	12	Black/White
4	Light Green	13	Red/White
5	Orange	14	Light Green/White
6	Light Blue	15	Light Blue/White
7	White/Black		
8	Red/Black		
9	Light Green/Black		

Product Construction:

Conductor:

- 28 and 24 AWG fully annealed stranded tinned copper per ASTM B-33

Insulation:

- Premium grade foamed Lo-Cap® color coded polypropylene
- Color code: See chart below

Shield:

- 100% Flexfoil® aluminum/polyester with 25% overlap, minimum, foil facing out
- Stranded tinned copper drain wire
- 70% tinned copper braid

Jacket:

- PVC, gray
- Temperature range: -20°C to +80°C

Applications:

- High speed computers
- Industrial equipment
- Control circuits
- Designed for low capacitance applications
- Suitable for EIA RS-232 and RS-423 CAD/CAM applications
- Suggested voltage rating: 30 volts

Features:

- Braid shield provides good flexibility
- Superior shielding where noise rejection is critical
- Assists system designers in meeting FCC Docket 20780 demands

Compliances:

- NEC Article 800 Type CM (UL: 75°C)
- UL Style 2919 (UL: 80°C, 30V)
- CSA CMH (CSA: 60°C)
- RoHS Compliant Directive 2002/95/EC
- Designed to meet UL 70,000 BTU Vertical Tray Flame Test
- Passes CSA CMH Flame Test

Packaging:

- 1000' (305 m) spools or reels
- 500' (152 m) spools or reels
- Other put-ups available—consult Customer Service



Multi-Paired, Foil Shield

UL 2464, NEC Type CMR (UL) c(UL), CSA CMG

Product Construction:

Conductor:

- 24 AWG fully annealed stranded tinned copper per ASTM B-33
- Twisted pairs

Insulation:

- Premium-grade, color-coded S-R PVC per UL 1061
- Color code: See chart below

Shield:

- 100% Flexfoil® aluminum/polyester with 25% overlap, minimum, foil facing out
- Stranded tinned copper drain wire

Jacket:

- PVC, gray
- Temperature range: -20°C to +80°C

Applications:

- Computers
- Industrial equipment
- Data transmission
- Control circuits
- Suitable for EIA RS-232 applications
- Suggested voltage rating: 300 volts

Features:

- Superior shielding where noise rejection is critical
- Assists system designers in meeting FCC Docket 20780 demands

Compliances:

- NEC Article 800 Type CMR (UL: 75°C)
- UL Style 2464 (UL: 80°C, 300V)
- CSA CMG (CSA, 60°C)
- RoHS Compliant Directive 2002/95/EC
- Designed to meet UL 70,000 BTU Vertical Tray Flame Test
- Passes CSA CMG Flame Test

Packaging:

- Please contact Customer Service for packaging and color options



CATALOG NUMBER	NO. OF PAIRS	AWG SIZE	COND. STRAND	NOMINAL INSULATION THICKNESS		NOMINAL JACKET THICKNESS		NOMINAL O.D.		NOMINAL DCR Ω/kft		NOMINAL CAP.* pF/ft	
				INCHES	mm	INCHES	mm	INCHES	mm	COND.	SHLD.	A	B
C0600A	1	24	7/32	0.010	0.25	0.032	0.81	0.157	3.99	25.7	7.2	19.7	21.5
C0601A	2	24	7/32	0.010	0.25	0.032	0.81	0.214	5.44	25.7	7.2	28.7	21.5
C0602A	3	24	7/32	0.010	0.25	0.032	0.81	0.225	5.72	25.7	7.2	25.7	21.5
C0603A	4	24	7/32	0.010	0.25	0.032	0.81	0.245	6.23	25.7	7.2	25.7	20.2
C0604A	5	24	7/32	0.010	0.25	0.032	0.81	0.265	6.73	25.7	7.2	25.7	20.2
C0605A	6	24	7/32	0.010	0.25	0.032	0.81	0.287	7.29	25.7	7.2	23.7	42.7
C0606A	7	24	7/32	0.010	0.25	0.032	0.81	0.287	7.29	25.7	7.2	23.7	42.7
C0607A	8	24	7/32	0.010	0.25	0.032	0.81	0.309	7.85	25.7	7.2	23.7	42.7
C0608A	9	24	7/32	0.010	0.25	0.032	0.81	0.331	8.41	25.7	7.2	23.7	42.7
C0609A	10	24	7/32	0.010	0.25	0.032	0.81	0.359	9.12	25.7	7.2	23.7	42.7
C0610A	15	24	7/32	0.010	0.25	0.032	0.81	0.410	10.41	25.7	7.2	23.7	42.7
C0611A	19	24	7/32	0.010	0.25	0.032	0.81	0.432	10.97	25.7	7.2	23.7	42.7
C0612A	25	24	7/32	0.010	0.25	0.032	0.81	0.505	12.84	25.7	7.2	23.7	42.7
C0720A	1	22	7/30	0.010	0.25	0.032	0.81	0.169	4.29	16.6	6.2	40.4	72.6
C0721A	2	22	7/30	0.010	0.25	0.032	0.81	0.234	5.94	16.6	6.2	32.3	58.1
C0722A	3	22	7/30	0.010	0.25	0.032	0.81	0.246	6.25	16.6	6.2	27.8	50.1
C0723A	4	22	7/30	0.010	0.25	0.032	0.81	0.269	6.83	16.6	6.2	27.8	50.1
C0724A	5	22	7/30	0.010	0.25	0.032	0.81	0.292	7.42	16.6	6.2	27.8	50.1
C0725A	6	22	7/30	0.010	0.25	0.032	0.81	0.317	8.05	16.6	6.2	25.5	45.9
C0726A	9	22	7/30	0.010	0.25	0.032	0.81	0.367	9.32	16.6	6.2	25.5	45.9
C0728A	15	22	7/30	0.010	0.25	0.032	0.81	0.457	11.62	16.6	6.2	25.5	45.9
C0729A	19	22	7/30	0.010	0.25	0.032	0.81	0.482	12.24	16.6	6.2	25.5	45.9
C0730A	27	22	7/30	0.010	0.25	0.032	0.81	0.576	14.36	16.6	6.2	26.0	46.0

*A - Capacitance between conductors

*B - Capacitance between one conductor and other conductors connected to shield

Color Code Chart

NO. OF PAIRS	COLOR	NO. OF PAIRS	COLOR
1	Black with Red	14	Green with White
2	Black with White	15	Green with Blue
3	Black with Green	16	Green with Yellow
4	Black with Blue	17	Green with Brown
5	Black with Yellow	18	Green with Orange
6	Black with Brown	19	White with Blue
7	Black with Orange	20	White with Yellow
8	Red with White	21	White with Brown
9	Red with Green	22	White with Orange
10	Red with Blue	23	Blue with Yellow
11	Red with Yellow	24	Blue with Brown
12	Red with Brown	25	Blue with Orange
13	Red with Orange	26	Brown with Yellow
		27	Brown with Orange

Multi-Paired, Foil Shield, Lo-Cap®

UL 2448, NEC Type CM (UL) c(UL), CMH

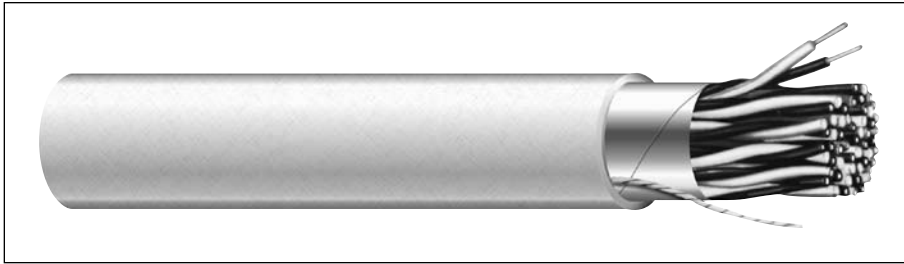

Product Construction:

Conductor:

- 24 AWG fully annealed stranded tinned copper per ASTM B-33
- Twisted pairs

Insulation:

- Premium-grade, color-coded polyethylene
- Color code: See chart below

Shield:

- 100% Flexfoil® aluminum/polyester with 25% overlap, minimum, foil facing out
- Stranded tinned copper drain wire

Jacket:

- PVC, gray
- Temperature range: -20°C to +75°C

Applications:

- Computers
- Industrial equipment
- Data transmission
- Control circuits
- Suitable for low capacitance applications
- Suggested voltage rating: 30 volts

Compliances:

- NEC Article 800 Type CM (UL: 75°C)
- UL Style 2448 (UL: 60°C, 30V)
- CSA CMH (CSA: 60°C)
- RoHS Compliant Directive 2002/95/EC
- Designed to meet UL 70,000 BTU Vertical Tray Flame Test
- Passes CSA CMH Flame Test

Packaging:

- Please contact Customer Service for packaging and color options

CATALOG NUMBER	NO. OF PAIRS	AWG SIZE	COND. STRAND	NOM. INSULATION THICKNESS		NOM. JACKET THICKNESS		NOMINAL O.D.		NOMINAL DCR		VEL. OF PROP., %	NOM. IMP., Ω	NOMINAL CAP.*	
				INCHES	mm	INCHES	mm	INCHES	mm	COND.	SHLD.			A	B
C0890A	2	24	7/32	0.015	0.38	0.032	0.81	0.247	6.27	25.7	7.20	66	100	14.4	26.0
C0901A	3	24	7/32	0.015	0.38	0.032	0.81	0.261	6.63	25.7	7.20	66	100	13.9	25.1
C0893A	4	24	7/32	0.015	0.38	0.032	0.81	0.277	7.04	25.7	7.20	66	100	13.9	25.1
C0894A	5	24	7/32	0.015	0.38	0.032	0.81	0.310	7.87	25.7	7.20	66	100	13.9	25.1
C0899A	6	24	7/32	0.015	0.38	0.032	0.81	0.336	8.53	25.7	7.20	66	100	13.0	23.4
C0896A	9	24	7/32	0.015	0.38	0.032	0.81	0.391	9.93	25.7	7.20	66	100	13.0	23.4
C0897A	12.5	24	7/32	0.015	0.38	0.032	0.97	0.459	11.66	25.7	7.20	66	100	13.0	23.4

*A – Capacitance between conductors

*B – Capacitance between one conductor and other conductors connected to shield

Color Code Chart

NO. OF PAIRS	COLOR	NO. OF PAIRS	COLOR
1	Black paired with White	7	White/Blue paired with Blue/White
2	Red paired with Green	8	White/Brown paired with Brown/White
3	Brown paired with Blue	9	White/Orange paired with Orange/White
4	Orange paired with Yellow	10	White/Green paired with Green/White
5	Violet paired with Gray	11	White/Red paired with Red/White
6	Tan paired with Pink	12	White/Black paired with Black/White
Single Conductor: Green With Yellow Stripe			



Designed to Meet UL Vertical Tray Flame Test
Underwriters Laboratories Inc.



Multi-Paired, Foil/Braid Shield

UL 2464, NEC Type CMR (UL) c(UL), CSA CMG

Product Construction:

Conductor:

- 22 and 24 AWG fully annealed stranded tinned copper per ASTM B-33
- Twisted pairs

Insulation:

- Premium-grade, color-coded S-R PVC per UL 1061
- Color code: See chart below

Shield:

- 100% Flexfoil® aluminum/polyester with 25% overlap, minimum, foil facing out
- 65% tinned copper braid

Jacket:

- PVC, gray
- Temperature range: -20°C to +80°C

Applications:

- Computers
- Industrial equipment
- Data transmission
- Control circuits
- Suitable for EIA RS-232 applications
- Suggested voltage rating: 300 volts

Features:

- Braid shield provides good flexibility
- Superior shielding where noise rejection is critical
- Assists system designers in meeting FCC Docket 20789 demands

Compliances:

- NEC Article 800 Type CMR (UL: 75°C)
- UL Style 2464 (UL: 80°C, 300V)
- CSA CMG (CSA: 60°C)
- RoHS Compliant Directive 2002/95/EC
- Designed to meet UL 70,000 BTU Vertical Tray Flame Test
- Passes CSA CMG Flame Test

Packaging:

- Please contact Customer Service for packaging and color options

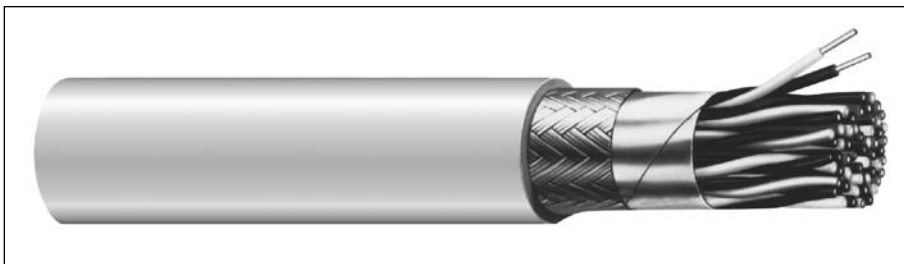

CATALOG NUMBER	NO. OF PAIRS	AWG SIZE	COND. STRAND	NOMINAL INSULATION THICKNESS		NOMINAL JACKET THICKNESS		NOMINAL O.D.		NOMINAL DCR Ω/kft		NOMINAL CAP.* pF/ft	
				INCHES	mm	INCHES	mm	INCHES	mm	COND.	SHLD.	A	B
C0620A	2	24	7/32	0.010	0.25	0.032	0.81	0.235	5.97	25.7	5.4	29.5	53.0
C0621A	3	24	7/32	0.010	0.25	0.032	0.81	0.231	5.87	25.7	5.0	26.4	47.6
C0622A	4	24	7/32	0.010	0.25	0.032	0.81	0.253	6.43	25.7	4.5	26.4	47.6
C0623A	5	24	7/32	0.010	0.25	0.032	0.81	0.278	7.06	25.7	4.6	26.4	47.6
C0624A	6	24	7/32	0.010	0.25	0.032	0.81	0.296	7.52	25.7	2.9	24.4	43.9
C0625A	7	24	7/32	0.010	0.25	0.032	0.81	0.313	7.95	25.7	3.1	24.4	43.9
C0626A	8	24	7/32	0.010	0.25	0.032	0.81	0.336	8.53	25.7	4.1	24.4	43.9
C0628A	10	24	7/32	0.010	0.25	0.032	0.81	0.357	9.07	25.7	2.6	24.4	43.9
C0630A	12.5	24	7/32	0.010	0.25	0.032	0.81	0.386	9.80	25.7	3.6	24.4	43.9
C0650A	2	22	7/30	0.010	0.25	0.032	0.81	0.229	5.82	16.6	3.8	33.2	59.7
C0651A	3	22	7/30	0.010	0.25	0.032	0.81	0.296	7.52	16.6	4.1	28.6	51.5
C0652A	4	22	7/30	0.010	0.25	0.032	0.81	0.320	8.13	16.6	3.5	28.6	51.5
C0653A	5	22	7/30	0.010	0.25	0.032	0.81	0.331	8.41	16.6	3.9	28.6	51.5
C0654A	6	22	7/30	0.010	0.25	0.032	0.81	0.348	8.84	16.6	4.4	26.2	47.2
C0655A	7	22	7/30	0.010	0.25	0.032	0.81	0.348	8.84	16.6	5.0	26.2	47.2
C0656A	8	22	7/30	0.010	0.25	0.032	0.81	0.368	9.35	16.6	3.8	26.2	47.2
C0658A	10	22	7/30	0.010	0.25	0.032	0.81	0.388	9.86	16.6	4.1	26.2	47.2
C0660A	12.5	22	7/30	0.010	0.25	0.032	0.81	0.429	10.90	16.6	4.7	26.2	47.2
C0663A	25	22	7/30	0.010	0.25	0.058	0.81	0.620	15.75	16.6	2.1	26.2	46.0

*A – Capacitance between conductors

*B – Capacitance between one conductor and other conductors connected to shield

Color Code Chart

NO. OF PAIRS	COLOR	NO. OF PAIRS	COLOR
1	Black paired with Red	13	Red paired with Orange
2	Black paired with White	14	White paired with Green
3	Black paired with Green	15	Blue paired with Green
4	Black paired with Blue	16	Yellow paired with Green
5	Black paired with Yellow	17	Brown paired with Green
6	Black paired with Brown	18	Orange paired with Green
7	Black paired with Orange	19	White paired with Blue
8	Red paired with White	20	White paired with Yellow
9	Red paired with Green	21	White paired with Brown
10	Red paired with Blue	22	White paired with Orange
11	Red paired with Yellow	23	Yellow paired with Blue
12	Red paired with Brown	24	Blue paired with Brown
		25	Orange paired with Blue

Single Conductor: Green with Yellow Stripe

Multi-Paired, Foil/Braid Shield, Lo-Cap®

UL 2919, NEC Type CM (UL) c(UL) CMH

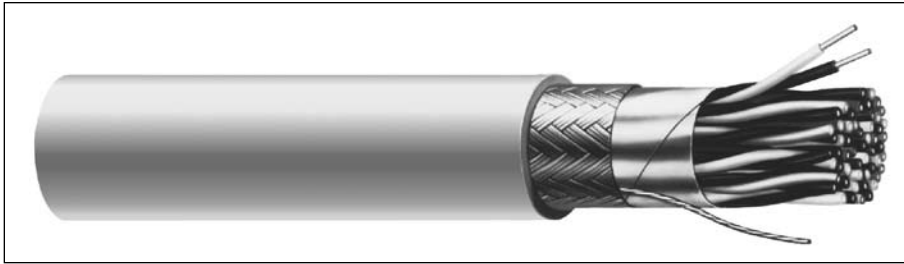

Product Construction:

Conductor:

- 24 AWG fully annealed stranded tinned copper per ASTM B-33
- Twisted pairs

Insulation:

- Premium-grade, color-coded polyethylene
- Color code: See charts below

Shield:

- 100% Flexfoil® aluminum/polyester with 25% overlap, minimum, foil facing out
- Stranded tinned copper drain wire
- 90% tinned copper braid

Jacket:

- PVC, gray
- Temperature range: -20°C to +80°C

Applications:

- Computers
- Industrial equipment
- Data transmission
- Control circuits
- Low capacitance requirements
- Suitable for EIA RS-485 applications
- Suggested voltage rating: 30 volts

Features:

- Braid shield provides good flexibility
- Superior shielding where noise rejection is critical
- Assists system designers in meeting FCC Docket 20789 demands

Compliances:

- NEC Article 800 Type CM/CMH (UL: 75°C)
- UL Style 2919 (UL: 80°C, 30V)
- RoHS Compliant Directive 2002/95/EC
- Designed to meet UL 70,000 BTU Vertical Tray Flame Test
- Passes CSA CMH Flame Test

Packaging:

- Please contact Customer Service for packaging and color options

CATALOG NUMBER	NO. OF PAIRS	AWG SIZE	COND. STRAND	NOM. INSULATION THICKNESS		NOM. JACKET THICKNESS		NOMINAL O.D.		NOMINAL DCR Ω/kft		VEL. OF PROP., %	NOM. IMP., Ω	NOMINAL CAP.* pF/ft	
				INCHES	mm	INCHES	mm	INCHES	mm	COND.	SHLD.			A	B
C0841A	1	24	7/32	0.024	0.61	0.032	0.81	0.235	5.97	25.7	2.9	66	120	14.6	26.2
C0842A	2	24	7/32	0.024	0.61	0.032	0.81	0.304	7.72	25.7	2.3	66	120	11.7	21.0
C0843A	3	24	7/32	0.024	0.61	0.032	0.81	0.360	9.14	25.7	2.3	66	120	11.9	21.4
C0844A	4	24	7/32	0.024	0.61	0.032	0.81	0.390	9.91	25.7	2.1	66	120	11.9	21.4

*A – Capacitance between conductors

*B – Capacitance between one conductor and other conductors connected to shield

Color Code Chart 1

NO. OF PAIRS	COLOR
1	Black paired with Red
2	Black paired with White
3	Black paired with Green
4	Black paired with Blue

CATALOG NUMBER	NO. OF PAIRS	AWG SIZE	COND. STRAND	NOM. INSULATION THICKNESS		NOM. JACKET THICKNESS		NOMINAL O.D.		NOMINAL DCR Ω/kft		VEL. OF PROP., %	NOM. IMP., Ω	NOMINAL CAP.* pF/ft	
				INCHES	mm	INCHES	mm	INCHES	mm	COND.	SHLD.			A	B
C4841A	1	24	7/32	0.024	0.61	0.032	0.81	0.235	5.97	25.7	2.9	66	120	14.6	26.2
C4842A	2	24	7/32	0.024	0.61	0.032	0.81	0.304	7.72	25.7	2.3	66	120	11.7	21.0
C4843A	3	24	7/32	0.024	0.61	0.032	0.81	0.360	9.14	25.7	2.3	66	120	11.9	21.4
C4844A	4	24	7/32	0.024	0.61	0.032	0.81	0.390	9.91	25.7	2.1	66	120	11.9	21.4

*A – Capacitance between conductors

*B – Capacitance between one conductor and other conductors connected to shield

Color Code Chart 2

NO. OF PAIRS	COLOR	NO. OF PAIRS	COLOR
1	White-Blue Stripe Blue-White Stripe	3	White-Green Stripe Green-White Stripe
2	White-Orange Stripe Orange-White Stripe	4	White-Brown Stripe Brown-White Stripe



Designed to Meet
UL Vertical Tray
Flame Test
Underwriters Laboratories Inc.



Multi-Paired, Foil/Braid Shield, Lo-Cap®

UL 2919, NEC Type CM (UL) c(UL) CMH

Product Construction:

Conductor:

- 24 AWG fully annealed stranded tinned copper per ASTM B-33
- Twisted pairs

Insulation:

- Premium-grade, color-coded polyethylene
- Color code: See chart below

Shield:

- 100% Flexfoil® aluminum/polyester with 25% overlap, minimum, foil facing out
- Stranded tinned copper drain wire
- 90% tinned copper braid

Jacket:

- PVC, gray
- Temperature range: -20°C to +80°C

Applications:

- Computers
- Industrial equipment
- Data transmission
- Control circuits
- Low capacitance requirements
- Suitable for EIA RS-232 applications
- Suitable for EIA RS-422 applications
- Suggested voltage rating: 30 volts

Features:

- Braid shield provides good flexibility
- Superior shielding where noise rejection is critical
- Assists system designers in meeting FCC Docket 20789 demands

Compliances:

- NEC Article 800 Type CM/CMH (UL: 75°C)
- UL Style 2919 (UL: 80°C, 30V)
- CSA CMH (CSA: 60°C)
- RoHS Compliant Directive 2002/95/EC
- Designed to meet UL 70,000 BTU Vertical Tray Flame Test
- Passes CSA CMH Flame Test

Packaging:

- Please contact Customer Service for packaging and color options

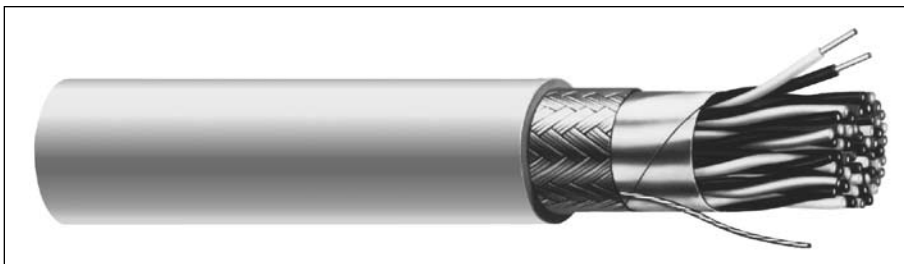

CATALOG NUMBER	NO. OF PAIRS	AWG SIZE	COND. STRAND	NOM. INSULATION THICKNESS		NOM. JACKET THICKNESS		NOMINAL O.D.		NOMINAL DCR Ω/kft		VEL. OF PROP., %	NOM. IMP., Ω	NOMINAL CAP.* pF/ft	
				INCHES	mm	INCHES	mm	INCHES	mm	COND.	SHLD.			A	B
C0829A	2	24	7/32	0.015	0.38	0.032	0.81	0.257	6.53	25.7	2.7	66	100	14.8	26.7
C0830A	3	24	7/32	0.015	0.38	0.032	0.81	0.289	7.34	25.7	2.6	66	100	14.2	25.5
C0831A	4	24	7/32	0.015	0.38	0.032	0.81	0.313	7.95	25.7	3.2	66	100	14.2	25.5
C0832A	5	24	7/32	0.015	0.38	0.032	0.81	0.338	8.59	25.7	1.9	66	100	14.2	25.5
C0839A	6	24	7/32	0.015	0.38	0.032	0.81	0.364	9.24	25.7	2.4	66	100	13.2	23.8
C0833A	7	24	7/32	0.015	0.38	0.032	0.81	0.364	9.24	25.7	2.0	66	100	13.2	23.8
C0835A	10	24	7/32	0.015	0.38	0.038	0.97	0.462	11.73	25.7	1.7	66	100	13.2	23.8
C0836A	12	24	7/32	0.015	0.38	0.038	0.97	0.479	12.17	25.7	1.8	66	100	13.2	23.8

*A – Capacitance between conductors

*B – Capacitance between one conductor and other conductors connected to shield

Color Code Chart

NO. OF COND.	COLOR	NO. OF COND.	COLOR
1	Black paired with Red	7	Black paired with Orange
2	Black paired with White	8	Red paired with White
3	Black paired with Green	9	Red paired with Green
4	Black paired with Blue	10	Red paired with Blue
5	Black paired with Yellow	11	Red paired with Yellow
6	Black paired with Brown	12	Red paired with Brown

Multi-Paired, Foil/Braid Shield, Lo-Cap®

UL 2919, NEC Type CM (UL) c(UL) CMH

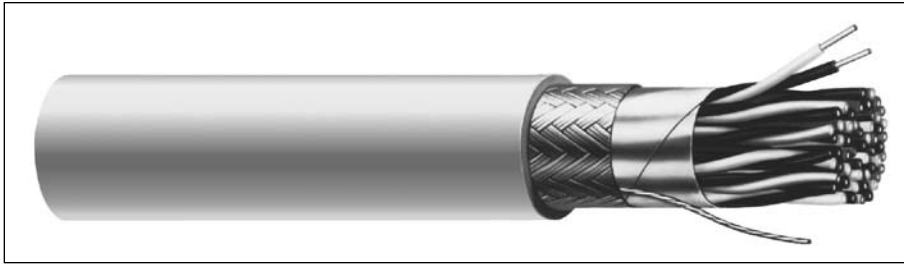

Product Construction:

Conductor:

- 24 AWG fully annealed stranded tinned copper per ASTM B-33
- Twisted pairs

Insulation:

- Premium-grade, color-coded Lo-Cap® foamed polypropylene
- Color code: See chart below

Shield:

- 100% Flexfoil® aluminum/polyester with 25% overlap, minimum, foil facing out
- Stranded tinned copper drain wire
- 65% tinned copper braid

Jacket:

- PVC, gray
- Temperature range: -20°C to +80°C

Applications:

- High-speed computer interconnects
- CAD/CAM systems
- EIA RS-232 and RS-423 systems
- Control circuits
- Industrial equipment
- Low signal distortion data requirements
- Suggested voltage rating: 30 volts

Features:

- Braid shield provides good flexibility
- Superior shielding where noise rejection is critical
- Assists system designers in meeting FCC Docket 20789 demands

Compliances:

- NEC Article 800 Type CM/CMH (UL: 75°C)
- UL Style 2919 (UL: 80°C, 30V)
- RoHS Compliant Directive 2002/95/EC
- Designed to meet UL 70,000 BTU Vertical Tray Flame Test

Packaging:

- Please contact Customer Service for packaging and color options

CATALOG NUMBER	NO. OF PAIRS	AWG SIZE	COND. STRAND	NOM. INSULATION THICKNESS		NOM. JACKET THICKNESS		NOMINAL O.D.		NOMINAL DCR Ω /kft		VEL. OF PROP., %	NOM. IMP., Ω	NOMINAL CAP.* pF/ft	
				INCHES	mm	INCHES	mm	INCHES	mm	COND.	SHLD.			A	B
C0515A	2	24	7/32	0.016	0.41	0.032	0.81	0.276	7.01	25.7	3.0	78	132	10.2	18.4
C0516A	3	24	7/32	0.016	0.41	0.032	0.81	0.290	7.37	25.7	3.2	78	132	9.9	17.8
C0517A	4	24	7/32	0.016	0.41	0.032	0.81	0.315	8.00	25.7	3.3	78	132	9.9	17.8
C0518A	5	24	7/32	0.016	0.41	0.032	0.81	0.340	8.64	25.7	4.2	78	132	9.9	17.8
C0519A	6	24	7/32	0.016	0.41	0.032	0.81	0.368	9.35	25.7	3.6	78	141	9.2	16.6
C0520A	7	24	7/32	0.016	0.41	0.032	0.81	0.370	9.40	25.7	3.5	78	141	9.2	16.6
C0521A	8	24	7/32	0.016	0.41	0.032	0.81	0.397	10.08	25.7	2.7	78	141	9.2	16.6
C0522A	10	24	7/32	0.016	0.41	0.038	0.97	0.473	12.01	25.7	2.4	78	141	9.2	16.6
C0523A	12.5	24	7/32	0.016	0.41	0.038	0.97	0.486	12.34	25.7	2.4	78	141	9.2	16.6
C0524A	15	24	7/32	0.016	0.41	0.048	1.22	0.555	14.10	25.7	2.6	78	141	9.2	16.6
C0525A	18	24	7/32	0.016	0.41	0.048	1.22	0.585	14.86	25.7	2.1	78	141	9.2	16.6
C0526A	25	24	7/32	0.016	0.41	0.048	1.22	0.677	17.20	25.7	2.0	78	141	9.2	16.6

*A – Capacitance between conductors

*B – Capacitance between one conductor and other conductors connected to shield

Color Code Chart

NO. OF PAIRS	COLOR	NO. OF PAIRS	COLOR	NO. OF PAIRS	COLOR
1	White-Blue Stripe Blue-White Stripe	10	Red-Gray Stripe Gray-Red Stripe	18	Yellow-Green Stripe Green-Yellow Stripe
2	White-Orange Stripe Orange-White Stripe	11	Black-Blue Stripe Blue-Black Stripe	19	Yellow-Brown Stripe Brown-Yellow Stripe
3	White-Green Stripe Green-White Stripe	12	Black-Orange Stripe Orange-Black Stripe	20	Yellow-Gray Stripe Gray-Yellow Stripe
4	White-Brown Stripe Brown-White Stripe	13	Black-Green Stripe Green-Black Stripe	21	Violet-Blue Stripe Blue-Violet Stripe
5	White-Gray Stripe Gray-White Stripe	14	Black-Brown Stripe Brown-Black Stripe	22	Violet-Orange Stripe Orange-Violet Stripe
6	Red-Blue Stripe Blue-Red Stripe	15	Black-Gray Stripe Gray-Black Stripe	23	Violet-Green Stripe Green-Violet Stripe
7	Red-Orange Stripe Orange-Red Stripe	16	Yellow-Blue Stripe Blue-Yellow Stripe	24	Violet-Brown Stripe Brown-Violet Stripe
8	Red-Green Stripe Green-Red Stripe	17	Yellow-Orange Stripe Orange-Yellow Stripe	25	Violet-Gray Stripe Gray-Violet Stripe
9	Red-Brown Stripe Brown-Red Stripe				

Single Conductor: Green with Yellow Stripe



Multi-Paired, Foil/Braid Shield, Lo-Cap®

UL 2960, NEC Type CL2

Product Construction:

Conductor:

- 28 AWG fully annealed stranded tinned copper per ASTM B-33
- Twisted pairs

Insulation:

- Premium-grade, color-coded polypropylene
- Color code: See chart below

Shield:

- 100% Flexfoil® aluminum/polyester with 25% overlap, minimum, foil facing out
- Stranded tinned copper drain wire
- 90% tinned copper braid

Jacket:

- PVC, gray
- Temperature range: -20°C to +75°C

Applications:

- Computers
- Industrial equipment
- Data transmission
- Control circuits
- Low capacitance requirements
- Suitable for EIA RS-232 applications
- Suitable for EIA RS-422 applications
- Suggested voltage rating: 30 volts

Features:

- Braid shield provides good flexibility
- Superior shielding where noise rejection is critical
- Assists system designers in meeting FCC Docket 20789 demands

Compliances:

- NEC Article 725 Type CL2 (UL: 75°C)
- UL Style 2960 (UL: 60°C, 30V)
- RoHS Compliant Directive 2002/95/EC
- Designed to meet UL 70,000 BTU Vertical Tray Flame Test

Packaging:

- Please contact Customer Service for packaging and color options

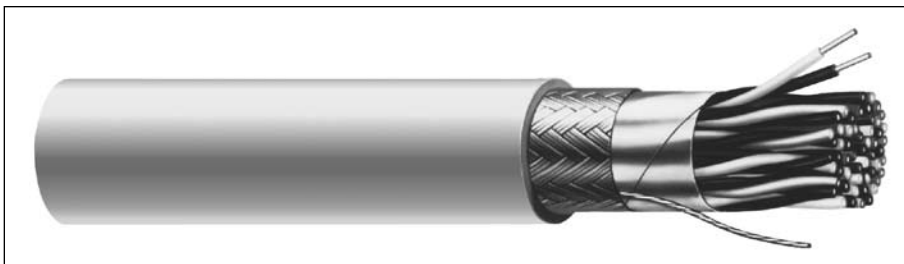

CATALOG NUMBER	NO. OF PAIRS	AWG SIZE	COND. STRAND	NOM. INSULATION THICKNESS		NOM. JACKET THICKNESS		NOMINAL O.D.		NOMINAL DCR Ω/kft		VEL. OF PROP., %	NOM. IMP., Ω	NOMINAL CAP.* pF/ft	
				INCHES	mm	INCHES	mm	INCHES	mm	COND.	SHLD.			A	B
C0804A	2	28	7/36	0.009	0.23	0.032	0.81	0.194	4.93	67.5	4.0	66	100	14.8	26.6
C0805A	3	28	7/36	0.009	0.23	0.032	0.81	0.194	4.93	67.5	4.2	66	100	14.0	25.3
C0806A	4	28	7/36	0.009	0.23	0.032	0.81	0.211	5.36	67.5	3.3	66	100	14.0	25.3
C0807A	5	28	7/36	0.009	0.23	0.032	0.81	0.226	5.74	67.5	3.5	66	100	14.0	25.3
C0808A	7	28	7/36	0.009	0.23	0.032	0.81	0.253	6.43	67.5	2.9	66	100	13.1	23.5
C0809A	9	28	7/36	0.009	0.23	0.032	0.81	0.286	7.26	67.5	2.9	66	100	13.1	23.5
C0810A	10	28	7/36	0.009	0.23	0.032	0.81	0.285	7.24	67.5	2.9	66	100	13.1	23.5
C0812A	12	28	7/36	0.009	0.23	0.032	0.81	0.294	7.47	67.5	3.3	66	100	13.1	23.5

*A – Capacitance between conductors

*B – Capacitance between one conductor and other conductors connected to shield

Color Code Chart

NO. OF COND.	COLOR	NO. OF COND.	COLOR
1	Black paired with Red	7	Black paired with Orange
2	Black paired with White	8	Red paired with White
3	Black paired with Green	9	Red paired with Green
4	Black paired with Blue	10	Red paired with Blue
5	Black paired with Yellow	11	Red paired with Yellow
6	Black paired with Brown	12	Red paired with Brown

Multi-Paired, Individually Foil Shielded

NEC Type CL2 and CM (UL) c(UL)

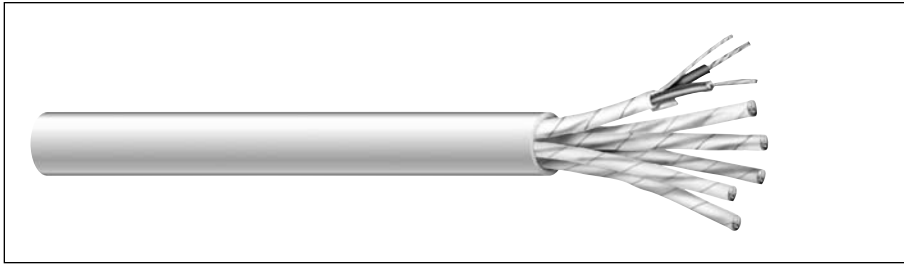

CATALOG NUMBER	NO. OF PAIRS	AWG SIZE	COND. STRAND	NOM. INSULATION THICKNESS		NOM. JACKET THICKNESS		NOMINAL O.D.		NOM. CAP.*	
				INCHES	mm	INCHES	mm	INCHES	mm	A	B
C1368A	4	20	7/28	0.015	0.38	0.032	0.81	0.364	9.25	23.0	41.5

*A – Capacitance between conductors

*B – Capacitance between one conductor and other conductors connected to shield

Color Code Chart

NO. OF PAIRS	COLOR
1	Red paired with White/Red
2	Black paired with White/Black
3	Green paired with White/Green
4	White paired with White/Yellow

Product Construction:

Conductor:

- 20 AWG fully annealed stranded tinned copper per ASTM B-33
- Twisted pairs

Insulation:

- Premium-grade, color-coded polypropylene
- Color code: See chart below

Shield:

- Individually shielded pairs
- 100% Flexfoil® aluminum/polyester with 25% overlap, minimum, foil facing in
- Stranded tinned copper drain wire each pair

Jacket:

- PVC, gray
- Temperature range: -20°C to +75°C

Applications:

- Applications for total isolation of signal
- Computers
- Control circuits
- Industrial equipment
- Suggested voltage rating: 300 volts

Features:

- Individually shielded pairs for excellent signal isolation
- Excellent high frequency properties
- Mechanical durability

Compliances:

- NEC Article 725 Type CL2 (UL: 75°C, 150V)
- NEC Article 800 Type CM (UL: 75°C, 300V)
- RoHS Compliant Directive 2002/95/EC
- Designed to meet UL 70,000 BTU Vertical Tray Flame Test

Packaging:

- Please contact Customer Service for packaging and color options



Designed to Meet
UL Vertical Tray
Flame Test

Underwriters Laboratories Inc.



Multi-Paired, Individually Foil Shielded

UL 2464, NEC Type CM (UL) c(UL), CSA CMG

Product Construction:

Conductor:

- 22 AWG fully annealed solid tinned copper per ASTM B-33
- Twisted pairs

Insulation:

- Premium-grade, color-coded PVC
- Color code: See chart below

Shield:

- Individually shielded pairs
- 100% Flexfoil® aluminum/polyester with 25% overlap, minimum, foil facing in
- Solid tinned copper drain wire each pair

Jacket:

- PVC, gray
- Temperature range: -20°C to +80°C

Applications:

- Applications for total isolation of signal
- Computers
- Control circuits
- Industrial equipment
- Suggested voltage rating: 300 volts

Features:

- Individually shielded pairs for excellent signal isolation
- Excellent high-frequency properties
- Mechanical durability

Compliances:

- NEC Article 800 Type CM (UL: 75°C)
- UL Style 2464 (UL: 80°C, 300V)
- CSA CMG (CSA: 60°C)
- RoHS Compliant Directive 2002/95/EC
- Designed to meet UL 70,000 BTU Vertical Tray Flame Test
- Passes CSA CMG Flame Test

Packaging:

- Please contact Customer Service for packaging and color options

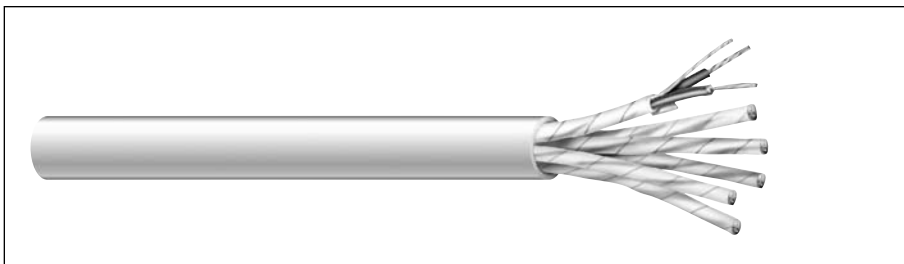

CATALOG NUMBER	NO. OF PAIRS	AWG SIZE	COND. STRAND	NOM. INSULATION THICKNESS		NOM. JACKET THICKNESS		NOMINAL O.D.		NOMINAL DCR Ω /kft		NOMINAL IMPEDANCE Ω	NOMINAL CAP.* pF/ft	
				INCHES	mm	INCHES	mm	INCHES	mm	COND.	SHLD.		A	B
C6035A	3	22	Solid	0.015	0.38	0.032	0.81	0.304	7.72	16.5	11.3	50	38.6	69.4
C6036A	6	22	Solid	0.015	0.38	0.032	0.81	0.397	10.08	16.5	11.3	50	38.6	69.4

*A – Capacitance between conductors

*B – Capacitance between one conductor and other conductors connected to shield

Color Code Chart

NO. OF PAIRS	COLOR	NO. OF PAIRS	COLOR
1	Black paired with Red	4	Black paired with Blue
2	Black paired with White	5	Black paired with Yellow
3	Black paired with Green	6	Black paired with Brown

Multi-Paired, Individually Foil Shielded

UL 2919, NEC Type CM, CSA CMH

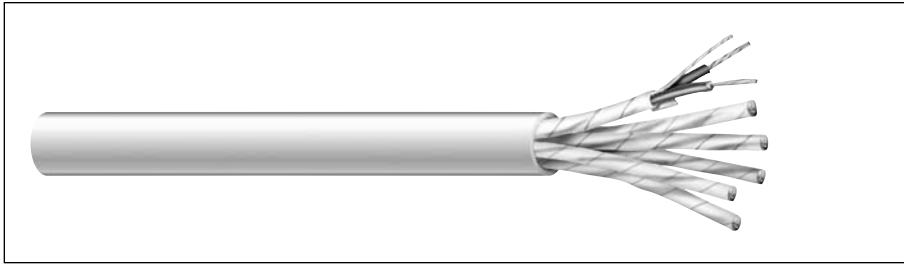

Product Construction:

Conductor:

- 24 thru 18 AWG fully annealed stranded tinned copper per ASTM B-33
- Twisted pairs

Insulation:

- Premium-grade, color-coded polyethylene
- Color code: See chart below

Shield:

- Individually shielded pairs
- 100% Flexfoil® aluminum/polyester with 25% overlap, minimum, foil facing in
- Stranded tinned copper drain wire each pair

Jacket:

- PVC, gray
- Temperature range: -20°C to +80°C

Applications:

- Applications for total isolation of signal
- Computers
- Control circuits
- Industrial equipment
- Suggested voltage rating: 30 volts

Features:

- Individually shielded pairs for excellent signal isolation
- Excellent high frequency properties
- Mechanical durability

Compliances:

- NEC Article 800 Type CM (UL: 75°C)
- UL Style 2919 (UL: 80°C, 30V)
- CSA CMH (CSA: 60°C)
- RoHS Compliant Directive 2002/95/EC
- Designed to meet UL 70,000 BTU Vertical Tray Flame Test
- Passes CSA CMH Flame Test

Packaging:

- Please contact Customer Service for packaging and color options

CATALOG NUMBER	NO. OF PAIRS	AWG SIZE	COND. STRAND	NOM. INSULATION THICKNESS		NOM. JACKET THICKNESS		NOMINAL O.D.		NOMINAL DCR Ω/kft	VEL. OF PROP., %	NOM. IMP., Ω	NOMINAL CAP.** pF/ft		
				INCHES	mm	INCHES	mm	INCHES	mm				COND. SHLD.	A	B
C6065A	3	24	7/32	0.011	0.28	0.032	0.81	0.269	6.83	26.0	18.0	66	71	21.7	39.0
C6066A	6	24	7/32	0.011	0.28	0.032	0.81	0.349	8.86	26.0	18.0	66	71	21.7	39.0
C6067A	9	24	7/32	0.011	0.28	0.032	0.81	0.406	10.31	26.0	18.0	66	71	21.7	39.0
C6040A	3	22	7/30	0.011	0.28	0.032	0.81	0.292	7.42	16.5	11.3	66	63	24.4	43.9
C6041A	6	22	7/30	0.011	0.28	0.032	0.81	0.381	9.68	16.5	11.3	66	63	24.4	43.9
C6042A	9	22	7/30	0.011	0.28	0.032	0.81	0.445	11.30	16.5	11.3	66	63	24.4	43.9
C6043A	11	22	7/30	0.011	0.28	0.032	0.81	0.486	12.34	16.5	11.3	66	63	24.4	43.9
C6059A	12	22	7/30	0.011	0.28	0.048	1.22	0.533	13.54	16.5	11.3	66	63	24.4	43.9
C6044A	15	22	7/30	0.011	0.28	0.048	1.22	0.591	15.01	16.5	11.3	66	63	24.4	43.9
C6060A	17	22	7/30	0.011	0.28	0.048	1.22	0.622	15.80	16.5	11.3	66	63	24.4	43.9
C6045A	19	22	7/30	0.011	0.28	0.048	1.22	0.622	15.80	16.5	11.3	66	63	24.4	43.9
C6046A*	27	22	7/30	0.011	0.28	0.048	1.22	0.696	17.68	16.5	11.3	66	63	24.4	43.9
C6052A	3	20	7/28	0.013	0.33	0.032	0.81	0.339	8.61	10.5	10.2	66	61	25.3	45.6
C6053A	6	20	7/28	0.013	0.33	0.032	0.81	0.446	11.33	10.5	10.2	66	61	25.3	45.6
C6054A	9	20	7/28	0.013	0.33	0.048	1.22	0.555	14.10	10.5	10.2	66	61	25.3	45.6
C6056A	12	20	7/28	0.013	0.33	0.048	1.22	0.623	15.82	10.5	10.2	66	61	25.3	45.6
C6058A	15	20	7/28	0.013	0.33	0.048	1.22	0.692	17.58	10.5	10.2	66	61	25.3	45.6
C6047A	3	18	16/30	0.016	0.41	0.032	0.81	0.395	10.03	7.2	8.3	66	60	25.7	46.2
C6048A	6	18	16/30	0.016	0.41	0.048	1.22	0.556	14.12	7.2	8.3	66	60	25.7	46.2
C6049A	9	18	16/30	0.016	0.41	0.048	1.22	0.649	16.48	7.2	8.3	66	60	25.7	46.2
C6050A	12	18	16/30	0.016	0.41	0.048	1.22	0.731	18.57	7.2	8.3	66	60	25.7	46.2
C6051A	15	18	16/30	0.016	0.41	0.048	1.22	0.776	19.71	7.2	8.3	66	60	25.7	46.2

*UL 2919, CSA CMH Only

**A – Capacitance between conductors

**B – Capacitance between one conductor and other conductors connected to shield

Color Code Chart

NO. OF PAIRS	COLOR	NO. OF PAIRS	COLOR	NO. OF PAIRS	COLOR
1	Black paired with Red	10	Red paired with Blue	19	White paired with Blue
2	Black paired with White	11	Red paired with Yellow	20	White paired with Yellow
3	Black paired with Green	12	Red paired with Brown	21	White paired with Brown
4	Black paired with Blue	13	Red paired with Orange	22	White paired with Orange
5	Black paired with Yellow	14	Green paired with White	23	Blue paired with Yellow
6	Black paired with Brown	15	Green paired with Blue	24	Blue paired with Brown
7	Black paired with Orange	16	Green paired with Yellow	25	Blue paired with Orange
8	Red paired with White	17	Green paired with Brown	26	Brown paired with Yellow
9	Red paired with Green	18	Green paired with Orange	27	Brown paired with Orange



Multi-Paired, Individually Foil Shielded, Lo-Cap®

UL 2493, NEC Type CM (UL) c(UL) CMH

Product Construction:

Conductor:

- 24 AWG fully annealed stranded tinned copper per ASTM B-33
- Twisted pairs

Insulation:

- Premium-grade, color-coded foamed Lo-Cap® polypropylene
- Color code: See chart below

Shield:

- Individually shielded pairs
- 100% Flexfoil® aluminum/polyester with 25% overlap, minimum, foil facing in
- Stranded tinned copper drain wire each pair

Jacket:

- PVC, gray
- Temperature range: -20°C to +75°C

Applications:

- High-speed computers
- Industrial equipment
- Control circuits
- Suitable for low capacitance applications
- Suitable for EIA RS-422 CAD/CAM applications
- Suggested voltage rating: 300 volts

Features:

- Individually shielded pairs for excellent signal isolation
- Excellent high-frequency properties
- Mechanical durability

Compliances:

- NEC Article 800 Type CM/CMH (UL: 75°C, 300V)
- UL Style 2493 (UL: 60°C)
- RoHS Compliant Directive 2002/95/EC
- Designed to meet UL 70,000 BTU Vertical Tray Flame Test

Packaging:

- Please contact Customer Service for packaging and color options

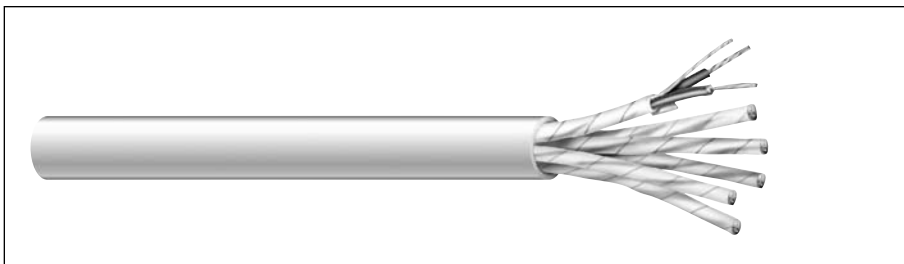

CATALOG NUMBER	NO. OF PAIRS	AWG SIZE	COND. STRAND	NOM. INSULATION THICKNESS		NOM. JACKET THICKNESS		NOMINAL O.D.		NOMINAL DCR Ω/kft		VEL. OF PROP., %	NOM. IMP., Ω	NOMINAL CAP.* pF/ft	
				INCHES	mm	INCHES	mm	INCHES	mm	COND.	SHLD.			A	B
C0910A	2	24	7/32	0.022	0.56	0.047	1.19	0.283	7.19	26.0	18.0	78	100	14.8	26.7
C0911A	3	24	7/32	0.022	0.56	0.048	1.22	0.381	9.68	26.0	18.0	78	100	14.8	26.7
C0912A	4	24	7/32	0.022	0.56	0.048	1.22	0.416	10.57	26.0	18.0	78	100	14.8	26.7
C0913A	6	24	7/32	0.022	0.56	0.048	1.22	0.492	12.50	26.0	18.0	78	100	14.8	26.7
C0914A	9	24	7/32	0.022	0.56	0.063	1.60	0.601	15.27	26.0	18.0	78	100	14.8	26.7
C0915A	11	24	7/32	0.022	0.56	0.063	1.60	0.652	16.56	26.0	18.0	78	100	14.8	26.7
C0916A	12	24	7/32	0.022	0.56	0.063	1.60	0.672	17.08	26.0	18.0	78	100	14.8	26.7
C0917A	15	24	7/32	0.022	0.56	0.063	1.60	0.743	18.87	26.0	18.0	78	100	14.8	26.7

*A – Capacitance between conductors

*B – Capacitance between one conductor and other conductors connected to shield

Color Code Chart

NO. OF PAIRS	COLOR	NO. OF PAIRS	COLOR
1	Black paired with Red	9	Red paired with Green
2	Black paired with White	10	Red paired with Blue
3	Black paired with Green	11	Red paired with Yellow
4	Black paired with Blue	12	Red paired with Brown
5	Black paired with Yellow	13	Red paired with Orange
6	Black paired with Brown	14	Green paired with White
7	Black paired with Orange	15	Green paired with Blue
8	Red paired with White		

Multi-Paired, Individually Foil/Braid Shielded, Lo-Cap®

UL 2493, NEC Type CM (UL) c(UL) CMH

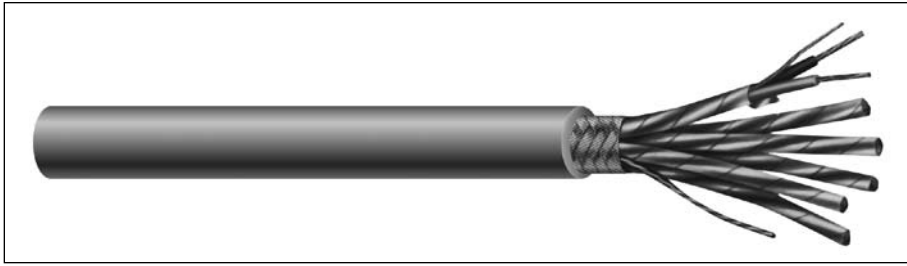

Product Construction:

Conductor:

- 24 AWG fully annealed stranded tinned copper per ASTM B-33
- Twisted pairs

Insulation:

- Premium-grade, color-coded foamed Lo-Cap® polypropylene
- Color code: See chart below

Shield:

- Individually shielded pairs
- 100% Flexfoil® aluminum/polyester with 25% overlap, minimum, foil facing in
- Stranded tinned copper drain wire, each pair
- 70% tinned copper braid, each pair

Jacket:

- PVC, gray
- Temperature range: -20°C to +75°C

Applications:

- High-speed computers
- Industrial equipment
- Control circuits
- Designed for low capacitance applications
- Suitable for RS-422 CAD/CAM applications
- Suggested voltage rating: 300 volts

Features:

- Individually shielded pairs for excellent signal isolation
- Excellent high-frequency properties
- Mechanical durability

Compliances:

- NEC Article 800 Type CM/CMH (UL: 75°C, 300V)
- UL Style 2493 (UL: 60°C)
- RoHS Compliant Directive 2002/95/EC
- Designed to meet UL 70,000 BTU Vertical Tray Flame Test

Packaging:

- Please contact Customer Service for packaging and color options

CATALOG NUMBER	NO. OF PAIRS	AWG SIZE	COND. STRAND	NOM. INSULATION THICKNESS		NOM. JACKET THICKNESS		NOMINAL O.D.		NOMINAL DCR**			VEL. OF PROP., %	NOM. IMP., Ω	NOMINAL CAP.*	
				INCHES	mm	INCHES	mm	INCHES	mm	C	D	E			A	B
C0924A	2	24	7/32	0.022	0.56	0.048	1.22	0.392	9.96	26.0	18.0	4.3	78	100	14.8	26.7
C0925A	3	24	7/32	0.022	0.56	0.048	1.22	0.410	10.41	26.0	18.0	4.4	78	100	14.8	26.7
C0926A	4	24	7/32	0.022	0.56	0.048	1.22	0.445	11.30	26.0	18.0	3.2	78	100	14.8	26.7

*A – Capacitance between conductors
 *B – Capacitance between one conductor and other conductors connected to shield
 **C – Conductor resistance
 **D – Individual shield resistance
 **E – Overall shield resistance

Color Code Chart

NO. OF PAIRS	COLOR
2	Black paired with White
3	Black paired with Green
4	Black paired with Blue



Coaxial Cable

5

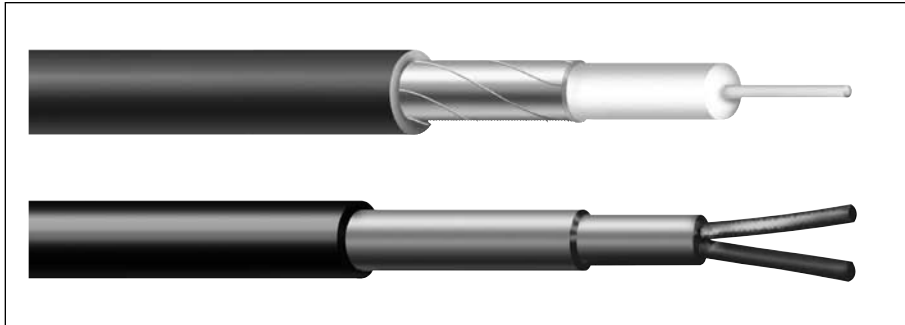

To meet the needs of today's sophisticated, high-speed, wide bandwidth electronics over long distances, with minimum signal loss or degradation, General Cable Carol® Brand offers a wide range of coaxial and twinaxial designs in both unbalanced arrays and precision-balanced pairs. This offers the system designer a wide choice of cost-effective products that reflect the most recent changes in the standards set by UL, CSA and/or the FCC.

Included in this section are recommended Carol® Brand coaxial products for the CATV market. However, these constructions may differ in certain parts of the country.

Unlike other products in the electronic market, coaxial cable does not have one accepted standard construction.

General Cable recommends, in order to avoid installing an unacceptable coaxial cable for the CATV application in your area, the local CATV company should be consulted.

General Cable's Carol® Brand product mix encompasses standard RG/U-type coaxial constructions in the more popular 50, 75 and 93 ohm designs and miniature coaxial products for smaller high-speed applications.

The twinaxial products meet or exceed the stringent demands of today's precision-balanced pair systems. The minimization of capacitance unbalance is a necessary requirement for long distance data transmission.

Index	Page
Coaxial Solutions Guide	86-87
RG 6/U Type	88-93
RG 8/U Type	94-95
RG 11/U Type	96-99
RG 58/U Type	100
RG 59/U Type	101-108
RG 62/U Type	109
RG 174/U Type	110
RG 213/U Type	111
Twinaxial Cables	112

Coaxial Cable Solutions Guide

CAROL BRAND

ELECTRONICS WIRE & CABLE

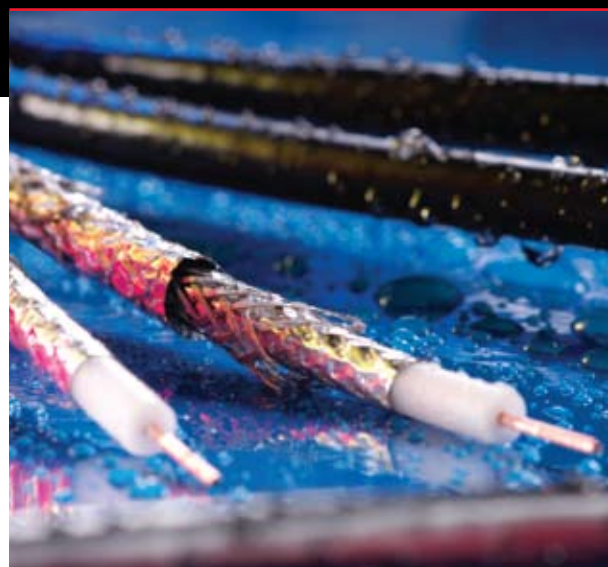

General Cable offers a complete line of Carol® Brand Coaxial Cables for today's sophisticated high-speed, wide-bandwidth electronics products that run over long distances with minimal signal loss or degradation.

General Cable has the right coaxial cable to serve every application, including:

- CATV/MATV/DBS
- HDTV/SDI
- CCTV

The General Cable Coaxial Cable Solutions Guide is a quick-reference tool to make it easier to specify and sell the right cable for the required application—residential, commercial, entertainment and security.

Whatever the application calls for, we have a coaxial cable that delivers the performance your customers need.

CATV/MATV/DBS



Broadband signal, 5MHz–3GHz, VHF/UHF, is traditionally transmitted as an analog signal received directly off air (MATV) or delivered as a community access television (CATV) service and uses a 75 Ohm system.

Recommended Coaxial Cable Construction: Copper clad steel (CCS) conductor with a foam polyethylene or Teflon® core, an aluminum/Mylar® foil, a minimum of 60% braid, which is typically aluminum (AL) for this application, and a PVC jacket.

For home use, a CM rated coax should be used. A commercial application may require a National Electrical Code (NEC 800 or 725) Riser (CMR) or Plenum (CMP) rated cable. Economical cable solutions use low smoke PVC (75°C) jackets. Teflon® (FEP) and other fluoropolymer materials (150°C) may be used to provide a more durable and higher-temperature cable alternative.

It is a common misconception that RG 6 coax is “better” than RG 59. While RG 6 has become the industry standard and is an excellent value, it is a larger cable than RG 59. RG 6 allows the same signal level to be delivered a greater distance. This is expressed as a decibel value at particular frequencies. For example, at 100 MHz, General Cable’s Carol® Brand part number C5775 RG 6 coax cable has an attenuation value of 2.05 db/100’. A similar construction Carol® Brand part number C5782 RG 59 coax cable exhibits an attenuation value (loss) at 100 MHz frequency of 2.70db/100’. This may or may not be significant, depending on the input signal level and distance of the cable run.

For a longer cable run, or if the coax cable is planned for use as the backbone in a system, Carol® Brand part number C5039 RG 11 coax cable should be used, because its attenuation at 100 MHz frequency is 1.30 db/100’.

CATV/MATV/DBS RG 59, RG 6 and RG 11 Ratings

Coax Solution	Carol	Belden	Genesis	West Penn	Commscope
 RG 6 CCS/Foil/60% AL Braid CATV/CM	C5775	9116/1829A	5303	841	5726
 RG 6 CCS/Foil/60% AL Braid CATVR/CMR	C5886	9116R	—	—	—
 RG 6 CCS/Quad/Foil/60%/40% AL Braid CATV/CM	C5785	1189A	5307	Q841	5740
 RG 6 CCS/Quad/Foil/60%/40% AL Braid CATVR/CMR	C5889	1884A	—	—	—
 RG 6 CCS/Foil/60% AL Braid CMP - Plenum	C3524	9116P	—	25841	2275K
 RG 6 CCS/Quad/Foil/60%/40% AL Braid CMP - Plenum	C3525	1189AP	—	25Q841	—
 RG 11 CCS/Foil/60% AL Braid CATV/CM	C5039	1525A	—	—	5913
 RG 11 CCS/Foil/60% AL Braid CL2P/CMP - Plenum	C3528	1523AP	—	—	2285K

*Note: DuPont™ trademark

CAROL BRAND

General Cable

HDTV/SDI









A DTV signal is a television signal provided in a digital form. Data bits, like in a computer, provide a dramatically better picture and better sound quality called High Definition TV (HDTV). HDTV is the highest quality of DTV and is only one of the available formats. In addition to enhanced picture quality, the DTV signal allows several program streams (multicasting) on one channel, providing more program potential, as well as interactive services.

Serial Digital Interface (SDI) is the standard for digital video transmission over coaxial cable. The SMPTE 295M standard provides maximum distances (300 meters; 140 meters for High Definition), typically at 270 Mbps with 540 Mbps possible over a coaxial cable.

Recommended Coax Cable Construction: Cable providing signal to and within the home/building will continue to be CCS construction (C5775, C5785). Cables with SBC conductors (395011, 495025) are recommended for the interconnect between the decoder box and other electronic devices (TV, DVD, DVR, CD, Bluray).

HDTV/SDI—Interconnect Cables *RG 59, RG 6 and RG 11 Ratings*

Coax Solution	Carol	Belden	Genesis	West Penn	Commscope
 RG 59 SBC/Foil/95% TC Braid CMR	395025	1505A	5361	819	5553
 RG 59 SBC/Foil/95% TC Braid CMP - Plenum	495023	1506A	—	—	—
 RG 6 SBC/Foil/95% TC Braid CMR	395011	1694A	—	—	5765
 RG 6 SBC/Foil/95% TC Braid CMP - Plenum	495025	1695A	—	—	—
 RG 11 SBC/Foil/95% TC Braid CMR	395029	7731A	—	—	—
 RG 11 SBC/Foil/95% TC Braid CMP - Plenum	495027	7732A	—	—	2286K









CCTV

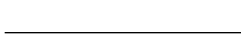

Closed Circuit TV (CCTV) signals are typically lower-frequency analog signals. Attenuation increases as frequency increases, therefore lower baseband signals are able to travel longer distances on an RG 59 type coaxial cable than a higher-frequency television signal. This is why RG 59 is the most common coax for CCTV. It is becoming more common for Unshielded Twisted Pair (UTP) products, like Category 5e and 6 cables, to be used for Closed Circuit over Twisted Pair (CCTP) or Web-enabled cameras implemented over a Power over Ethernet network architecture; however, these solutions require the use of specialized equipment.

Recommended Coax Cable Construction: Solid bare copper (SBC) conductor and a bare copper (BC) braid shield with coverage of 90-95% to minimize signal loss of both the horizontal and vertical sync signals. Stranded conductors are recommended for pan, zoom, tilt (PZT) cameras.

CCTV *RG 59 and RG 11 Ratings*

Coax Solution	Carol	Belden	Genesis	West Penn	Commscope
 RG 59 SBC/95% BC Braid CM	C1142	543945	5001	—	—
 RG 59 Stranded (7/30) BC/95% BC Braid CM	C1103	9259	—	—	—
 RG 59 Stranded (7/30) BC/95% BC Braid + 22 AWG (7/30) Shielded Pair CM	C8025	9265	—	—	—
 RG 59 SBC/95% BC Braid + 18 AWG (7/26) Unshielded Pair CM	C8028	549945	—	—	—
 RG 59 SBC/95% BC Braid + 18 AWG (7/26) Unshielded Pair CMP - Plenum	C8030	649948	—	—	—
 RG 59 SBC/95% BC Braid CMP - Plenum	495028	643948	5351	25815	2037V
 RG 11 SBC/95% BC Braid CM	395058	513945	—	811	5905
 RG 11 SBC/95% BC Braid CMP - Plenum	495015	613948	—	—	2286K
 RG 6 BC/95% BC Braid CMP - Plenum	495035	—	—	—	2277V

*Abbreviation Key

AL - aluminum

SBC - solid bare copper

CCS- copper clad steel

BC - bare copper

TC - tinned copper

RG 6/U Type

Product Construction:

Conductors:

- Copper per ASTM B-3
- Copper-clad steel per ASTM B-869

Insulation/Core:

- Foam polyethylene (PE) design

Shield:

- Bare copper or aluminum braid
- Flexfoil® shield

Jacket:





- Premium PVC compound

Packaging:

- Please contact Customer Service for packaging and color options

Applications:

- Suitable for RF signal transmission
- MATV
- CATV
- CCTV†
- HDTV
- Digital video
- Drop cable
- FM broadcast
- See Coax Connector Cross Reference, pages 192-199

CATALOG NUMBER	AWG SIZE NOM. DCR	INSULATION MATERIAL		SHIELD COVERAGE NOM SHLD DCR	NOMINAL O.D.		NOMINAL CAPACITANCE		VELOCITY OF PROPAGATION, %	NOMINAL IMPEDANCE, Ω	NOMINAL ATTENUATION	
		INCHES	mm		INCHES	mm	pF/ft	pF/m			MHz	dB/100'
C5760 RG 6/U Type 	18 Ga. Copper-Clad Steel 28.9 Ω/Mft.	Foam PE		100% Flexfoil® 30 Ga. CCS Spiral Served Shield 30.0 Ω/Mft.	Black PVC		16.20	53.15	82	75	1	0.26
		0.180	4.57		0.240	6.10					10	0.81
C5761† RG 6/U Type UL CL2, CATV, CM c(UL) CM 	18 Ga. Solid Bare Copper 6.5 Ω/Mft.	Foam PE		100% Flexfoil® +95% Bare Copper Braid 2.6 Ω/Mft.	Black PVC		16.20	53.15	83	75	1	0.26
		0.180	4.57		0.275	6.98					10	0.81
C5775 RG 6/U Type UL CL2, CATV, CM c(UL) CM 	18 Ga. Solid Copper-Clad Steel 28.9 Ω/Mft.	Foam PE		100% Flexfoil® Bonded +60% Aluminum Braid 9.0 Ω/Mft.	Black PVC		16.20	53.15	83	75	1	0.26
		0.180	4.57		0.275	6.98					10	0.81
C5886 RG 6/U Type Riser UL CL2R, CATVR, CMR c(UL) CMR 	18 Ga. Solid Copper-Clad Steel 28.9 Ω/Mft.	Foam PE		100% Flexfoil® Bonded +60% Aluminum Braid 9.0 Ω/Mft.	Black PVC		16.20	53.15	83	75	1	0.26
		0.180	4.57		0.275	6.98					10	0.81
C5776 RG 6/U Type UL CL2, CATV, CM c(UL) CM 	18 Ga. Solid Copper-Clad Steel 28.9 Ω/Mft.	Foam PE		100% Flexfoil® Bonded +95% Aluminum Braid 10.5 Ω/Mft.	Black PVC		16.20	53.15	83	75	1	0.26
		0.180	4.57		0.275	6.98					10	0.81

RG 6/U Type

Product Construction:

Conductors:

- Copper-clad steel per ASTM B-869

Insulation/Core:

- Solid and foam polyethylene (PE) designs

Shield:

- Tinned, bare copper or aluminum braid
- Flexfoil® shield

Jacket:





- Premium PVC compound or PE compound

Packaging:

- Please contact Customer Service for packaging and color options

Applications:

- CATV
- MATV
- HDTV
- Digital video
- Direct burial
- See Coax Connector Cross Reference, pages 192-199

CATALOG NUMBER	AWG SIZE NOM. DCR	INSULATION MATERIAL		SHIELD COVERAGE NOM SHLD DCR	NOMINAL O.D.		NOMINAL CAPACITANCE		VELOCITY OF PROPAGATION, %	NOMINAL IMPEDANCE, Ω	NOMINAL ATTENUATION	
		INCHES	mm		INCHES	mm	pF/ft	pF/m			MHz	dB/100'
C5785 RG 6/U Type Quad-Shield UL CL2, CATV, CM c(UL) CM 	18 Ga. Solid Copper-Clad Steel 28.9 Ω/Mft.	Foam PE		(2) 100% Flexfoil® 1st Bonded (1) 60% (2) 40% Aluminum Braids 3.7 Ω/Mft.	Black PVC		16.20	53.15	83	75	1	0.26
		0.180	4.57		0.292	7.42						10
C5889 RG 6/U Type Riser Quad-Shield UL CL2R, CATVR, CMR c(UL) CM 	18 Ga. Solid Copper-Clad Steel 28.9 Ω/Mft.	Foam PE		(2) 100% Flexfoil® 1st Bonded (1) 60% (2) 40% Aluminum Braids 3.7 Ω/Mft.	Black PVC		16.20	53.15	83	75	1	0.26
		0.180	4.57		0.292	7.42						10
C5777 RG 6/U Type UL CL2, CATV, CM c(UL) CM 	18 Ga. Solid Copper-Clad Steel 28.9 Ω/Mft.	Foam PE		100% Flexfoil® Bonded +61% Tinned Copper Braid 6.5 Ω/Mft.	Black PVC		16.20	53.15	83	75	1	0.26
		0.180	4.57		0.275	6.98						10
C5802 RG 6/U Type Messengered, Self-Supporting 	18 Ga. Solid Copper-Clad Steel 28.9 Ω/Mft.	Foam PE		100% Flexfoil® Bonded +60% Aluminum Braid 9.0 Ω/Mft.	Black PVC		16.20	53.15	83	75	1	0.26
		0.180	4.57		0.270 x 0.428	6.86 x 10.87						10
C5804 RG 6/U Type MoistureGuard™ Direct Burial, Flooded 	18 Ga. Solid Copper-Clad Steel 28.9 Ω/Mft.	Foam PE		100% Flexfoil® Bonded +60% Aluminum Braid w/water block 9.0 Ω/Mft.	Black PE		16.20	53.15	83	75	1	0.26
		0.180	4.57		0.275	6.98						10

RG 6/U Type

Product Construction:

Conductors:

- Copper per ASTM B-3
- Copper-clad steel per ASTM B-869

Insulation/Core:

- Foam polyethylene (PE) design

Shield:

- Tinned copper or aluminum braid
- Flexfoil® shield

Jacket:



- Premium PVC compound

Packaging:

- Please contact Customer Service for packaging and color options

Applications:

- LAN cable
- HDTV
- CCTV†
- Digital video
- Direct broadcast satellite
- See Coax Connector Cross Reference, pages 192-199

CATALOG NUMBER	AWG SIZE NOM. DCR	INSULATION MATERIAL		SHIELD COVERAGE NOM SHLD DCR	NOMINAL O.D.		NOMINAL CAPACITANCE		VELOCITY OF PROPAGATION, %	NOMINAL IMPEDANCE, Ω	NOMINAL ATTENUATION	
		INCHES	mm		INCHES	mm	pF/ft	pF/m			MHz	dB/100'
C5814† RG 6/U Type Digital Video/HDTV UL CL2, CATV, CM c(UL) CM 	18 Ga. Solid Bare Copper 6.5 Ω/Mft.	Foam PE		100% Flexfoil® +95% Tinned Copper Braid 2.7 Ω/Mft.	Black PVC		16.20	53.15	83	75	1	0.20
		0.180	4.57		0.275	6.98					10	0.72
C5822 RG 6/U Dual-Type DBS UL CL2, CATV, CM c(UL) CM 	18 Ga. Solid Copper-Clad Steel 28.9 Ω/Mft.	Foam PE		100% Flexfoil® Bonded +60% Aluminum Braid 9.0 Ω/Mft.	Black PVC		16.20	53.15	83	75	1	0.26
		0.180	4.57		0.267 x 0.595	6.86 x 15.11					10	0.81
											50	1.48
											100	2.01
											200	2.79
											500	4.46
											1000	6.53
											1450	7.86
											1800	8.76
											2200	9.69
											3000	11.31
											1	0.26
											10	0.81
											50	1.46
											100	2.05
											200	2.83
											500	4.53
											1000	6.59
											1450	8.10
											1800	8.80
											2200	10.10
											3000	11.79

RG 6/U Type

Product Construction:

Conductors:

- Copper per ASTM B-3 or copper-clad steel per ASTM B-869
- Twisted pair color code: black and red

Insulation/Core:

- Foam polyethylene (PE) design
- Foam fluoropolymer (FEP) design

Shield:

- Tinned copper or aluminum braid
- Flexfoil® shield

Jacket:







- Premium-grade PVC compound

Packaging:

- Please contact Customer Service for packaging and color options

Applications:

- Suitable for RF signal transmission
- CATV
- CCTV†
- DBS
- Drop cable
- FM broadcast
- HDTV
- Digital video
- See Coax Connector Cross Reference, pages 192-199

CATALOG NUMBER	AWG SIZE NOM. DCR	INSULATION MATERIAL		SHIELD COVERAGE NOM SHLD DCR	NOMINAL O.D.		NOMINAL CAPACITANCE		VELOCITY OF PROPAGATION, %	NOMINAL IMPEDANCE, Ω	NOMINAL ATTENUATION	
		INCHES	mm		INCHES	mm	pF/ft	pF/m			MHz	dB/100'
C5778 RG 6/U Type UL CL2, CATV, CM c(UL) CM 	18 Ga. Solid Bare Copper 6.5 Ω/Mft.	Foam PE		100% Flexfoil® Bonded +61% Tinned Copper Braid 6.5 Ω/Mft.	Black PVC		16.20	53.15	83	75	1	0.26
		0.180	4.57		0.275	6.98					10	0.81
								50	1.46			
											100	2.05
											200	2.83
											500	4.53
											1000	6.59
											1450	8.10
											1800	8.80
											2200	10.10
											3000	11.79
C3523 RG 6/U Type Plenum UL CL2P, CMP c(UL) CMP 	18 Ga. Solid Bare Copper 6.5 Ω/Mft.	Fluoropolymer		100% Flexfoil® +80% Tinned Copper Braid 2.3 Ω/Mft.	Flexguard® PVC Natural		16.40	52.50	83	75	1	0.30
		0.170	4.32		0.232	5.89					10	0.66
								50	1.50			
											100	2.10
											200	3.10
											500	5.00
											1000	7.30
C3521 RG 6/U Type Plenum UL CL2P, CMP c(UL) CMP 	18 Ga. Solid Bare Copper 6.5 Ω/Mft.	Fluoropolymer		Flexfoil® Bonded +95% Tinned Copper Braid 2.3 Ω/Mft.	Flexguard® PVC Natural		16.00	52.50	83	75	1	0.30
		0.170	4.32		0.232	5.89					10	0.66
								50	1.50			
											100	2.10
											200	3.10
											500	5.00
											1000	7.30
C3524 RG 6/U Type Plenum UL CL2P, CMP c(UL) CMP 	18 Ga. Solid Copper-Clad Steel 28.6 Ω/Mft.	Fluoropolymer		Flexfoil® Bonded +80% Aluminum Braid 9.0 Ω/Mft.	Flexguard® PVC Natural		16.00	52.50	83	75	1	0.30
		0.170	4.32		0.232	5.89					10	0.66
								50	1.50			
											100	2.10
											200	3.10
											500	5.00
											1000	7.30
											2300	12.20
											3000	14.28
C3525 RG 6/U Type Quad Shield Plenum UL CL2P, CMP c(UL) CMP 	18 Ga. Solid Copper-Clad Steel 28.6 Ω/Mft.	Fluoropolymer		(2) 100% Flexfoil® (1) 60% (2) 40% Aluminum Braids 5.3 Ω/Mft.	Flexguard® PVC Natural		16.00	52.50	83	75	1	0.30
		0.170	4.32		0.306	7.77					10	0.66
								50	1.50			
											100	2.10
											200	3.10
											500	5.00
											1000	7.30
											2300	12.20
											3000	14.28
C8029† RG 6/U Type +18 AWG Unshielded Pair UL CL2, CATV, CM c(UL) CM 	18 Ga. Solid Bare Copper Coax	Foam PE		100% Flexfoil® 95% Bare Copper Braid 1.9 Ω/Mft.	Black PVC		16.20	53.15	83	75	1	0.20
		0.180	4.57		0.270	6.86					10	0.72
		Premium PVC									100	2.01
		0.010	0.25	Unshielded Pair							200	2.70
									500	4.46		
											1000	6.53
C8031† RG 6/U Type +18 AWG Unshielded Pair UL CMP c(UL) CMP 	18 AWG Solid Bare Copper Coax	Fluoropolymer		95% Bare Copper Braid 3.5 Ω/Mft.	Natural PVC		16.30	53.48	83	75	1	0.30
		0.170	0.432		0.232	5.89					10	0.66
					Halar							
		0.006	0.15	Unshielded Pair							200	3.10
									500	5.00		
											1000	7.30

RG 6/U Type

Product Construction:

Conductors:

- Copper per ASTM B-3

Insulation/Core:

- Foam polyethylene (PE) design

Shield:

- Tinned copper braid
- Flexfoil® shield

Jacket:





- Premium-grade PVC compound

Packaging:

- Please contact Customer Service for packaging and color options

Applications:

- Broadcast grade headend
- Serial Digital Interface (SDI)
- CATV
- DBS
- Drop cable
- HDTV
- CCTV†
- Digital video
- See Coax Connector Cross Reference, pages 192-199

CATALOG NUMBER	AWG SIZE NOM. DCR	INSULATION MATERIAL		SHIELD COVERAGE NOM SHLD DCR	NOMINAL O.D.		NOMINAL CAPACITANCE		VELOCITY OF PROPAGATION, %	NOMINAL IMPEDANCE, Ω	NOMINAL ATTENUATION										
		INCHES	mm		INCHES	mm	pF/ft	pF/m			MHz	dB/100'									
395011 UL CMR c(UL) CMG 	18 Ga. Solid Bare Copper 6.5 Ω/Mft.	Foam PE		Dual Foil + 95% Tinned Copper Braid Shield 2.8 Ω/Mft.	Flame-Retardant PVC		16.20	53.10	83	75	1	0.24									
		0.180	4.57		0.275	6.91					3.6	0.45	135	2.10	270	2.97	540	4.25	1500	7.33	2250
495035† UL CMP c(UL) CMP 75°C 	18 Ga. Solid Bare Copper 6.7 Ω/Mft.	Fluoropolymer		95% Bare Copper Braid 2.0 Ω/Mft.	Plenum PVC		16.20	52.50	83	75	1	0.21									
		0.170	4.32		0.232	5.89					10	0.65	50	1.46	100	2.04	200	2.98	540	5.18	1000
495036† UL CMP c(UL) CMP 105°C 	18 Ga. Solid Bare Copper 6.7 Ω/Mft.	Fluoropolymer		95% Bare Copper Braid 2.0 Ω/Mft.	PVDF		16.10	53.00	83	75	1	0.21									
		0.170	4.32		0.232	5.89					10	0.65	50	1.46	100	2.04	200	2.98	540	5.18	1000
495025 UL CMP c(UL) CMP 	18 Ga. Solid Bare Copper 6.5 Ω/Mft.	Fluoropolymer		Dual Foil + 95% Tinned Copper Braid Shield 2.8 Ω/Mft.	Plenum PVC		16.10	53.00	83	75	1	0.24									
		0.170	4.32		0.232	5.89					3.6	0.45	135	2.40	270	2.75	540	4.00	1500	6.36	2250

RG 6/U Multi-Channel Digital/Precision, Riser Rated

75 Ohm High-End Coaxial Cables for Exacting Video, Analog, Digital & Monitor Applications

Product Construction:**Conductors:**

- Copper per ASTM B-3

Insulation/Core:

- Foam polyethylene (PE) design

Shield:

- Dual Flexfoil® shield
- Tinned copper braid

Jacket:



- Outer jacket: black matte finish thermoplastic elastomer (TPE)
- Inner jacket: flame-retardant PVC; see color codes below

Packaging:

- Please contact Customer Service for packaging and color options

Applications:

- Analog/Digital Video Broadcast-Grade Monitor
- HDTV
- See Coax Connector Cross Reference, pages 192-199

CATALOG NUMBER	AWG SIZE NOM. DCR	INSULATION MATERIAL		SHIELD COVERAGE NOM SHLD DCR	NOMINAL O.D.		NOMINAL CAPACITANCE		VELOCITY OF PROPAGATION, %	NOMINAL IMPEDANCE, Ω	NOMINAL ATTENUATION	
		INCHES	mm		INCHES	mm	pF/ft	pF/m			MHz	dB/100'
395011-3 UL CMR c(UL) CMG 	18 Ga. 3/Cond. Solid Bare Copper 6.5 Ω/Mft.	Foam PE		Bi-Metal Foil + 95% Tinned Copper Braid Shield (2.8 Ohm)	Inner: Flame-Retardant PVC Outer: TPE matte		16.20	53.20	83	75	1 3.6 71.5 270 540 1500	0.24 0.45 1.60 2.97 4.25 7.33
		0.180	4.57		0.685	17.40						
395011-4 UL CMR c(UL) CMG 	18 Ga. 4/Cond. Solid Bare Copper 6.5 Ω/Mft.	Foam PE		Bi-Metal Foil + 95% Tinned Copper Braid Shield (2.8 Ohm)	Inner: Flame-Retardant PVC Outer: TPE matte		16.20	53.20	83	75	1 3.6 71.5 270 540 1500	0.24 0.45 1.60 2.97 4.25 7.33
		0.180	4.57		0.755	19.18						
395011-5 UL CMR c(UL) CMG 	18 Ga. 5/Cond. Solid Bare Copper 6.5 Ω/Mft.	Foam PE		Bi-Metal Foil + 95% Tinned Copper Braid Shield (2.8 Ohm)	Inner: Flame-Retardant PVC Outer: TPE matte		16.20	53.20	83	75	1 3.6 71.5 270 540 1500	0.24 0.45 1.60 2.97 4.25 7.33
		0.180	4.57		0.860	21.85						

Inner Jacket Color Code Chart

Ordering Suffix	COLOR
1	Red
2	Green
3	Blue
4	White
5	Yellow

Note: 395011-3 will have the first three colors,
395011-4 will have the first four colors
and 395011-5 will have all five colors.

RG 8/U Type

Product Construction:

Conductors:

- Copper per ASTM B-3

Insulation/Core:

- Solid and cellular polyethylene designs

Shield:

- Tinned or bare copper braid
- Flexfoil® shield

Jacket:





- Premium PVC compound

Packaging:

- Please contact Customer Service for packaging and color options

Applications:

- Suitable for RF signal transmission
- Broadcast
- See Coax Connector Cross Reference, pages 192-199

CATALOG NUMBER	AWG SIZE NOM. DCR	INSULATION MATERIAL		SHIELD COVERAGE NOM SHLD DCR	NOMINAL O.D.		NOMINAL CAPACITANCE		VELOCITY OF PROPAGATION, %	NOMINAL IMPEDANCE, Ω	NOMINAL ATTENUATION	
		INCHES	mm		INCHES	mm	pF/ft	pF/m			MHz	dB/100'
C1108A RG 8/U Mini Type UL CL2, CM CSA CMG 1354 	16 Ga. (19/28) Bare Copper 4.2 Ω/Mft.	Foam PE		95% Bare Copper Braid 3.3 Ω/Mft.	Black PVC		25.30	83.01	80	50	1	0.26
		0.155	3.94		0.242	6.15					10	0.98
C1154 RG 8/U Type JAN-C-17A TYPE 1354 	13 Ga. (7/21) Bare Copper 1.9 Ω/Mft.	Solid PE		95% Bare Copper Braid 1.2 Ω/Mft.	Black PVC		29.50	96.79	66	52	1	0.16
		0.285	7.24		0.405	10.29					10	0.56
C1198 RG 8/U Type 1354 	11 Ga. (19/24) Bare Copper 1.9 Ω/Mft.	Foam PE		95% Bare Copper Braid 1.1 Ω/Mft.	Black PVC		26.00	85.31	78	50	1	0.17
		0.285	7.24		0.405	10.29					10	0.57
C1180 RG 8/U Type 	9½ Ga. Solid Bare Copper 0.90 Ω/Mft.	Semi-Solid PE		100% Flexfoil® Bonded +88% Tinned Copper Braid 1.8 Ω/Mft.	Black PVC		24.60	80.71	84	50	1	0.13
		0.285	7.24		0.405	10.29					10	0.40

RG 8/U Type Thicknet/Trunk Cable

50 Ohm IEEE 802.3 and ISO/IEC 8802.3 10 Base 5 LAN and Computer Cables

Product Construction:

Conductors:

- Copper per ASTM B-3

Insulation/Core:

- Foam polyethylene (PE) design
- Foam fluoropolymer (FEP) design

Shield:

- Tinned copper braid
- Flexfoil® shield

Jacket:



- Premium PVC compound
- Premium fluoropolymer compound

Packaging:

- Please contact Customer Service for packaging and color options

Applications:

- LAN & data transmission computer cables
- Thicknet/trunk cable – IEEE 802.3 and ISO/IEC 8802.3 10 base 5 LAN computer cables
- See Coax Connector Cross Reference, pages 192-199

CATALOG NUMBER	AWG SIZE NOM. DCR	INSULATION MATERIAL		SHIELD COVERAGE NOM SHLD DCR	NOMINAL O.D.		NOMINAL CAPACITANCE		VELOCITY OF PROPAGATION, %	NOMINAL IMPEDANCE, Ω	NOMINAL ATTENUATION	
		INCHES	mm		INCHES	mm	pF/ft	pF/m			MHz	dB/100'
397001 RG 8/U Type THICKNET DEC 17-000451-00 UL CM c(UL) 	12 Ga. Solid Bare Copper 1.42 Ω/Mft.	Foam PE		Quad Shield Dual Flexfoil® 94% Tinned Copper Braid + Dual Flexfoil® 94% Tinned Copper Braid 1.52 Ω/Mft.	Yellow Flame-Retardant PVC		26.00	85.30	78	50	1	0.17
		0.245	6.22		0.405	10.29					5	0.37
											10	0.53
											50	1.20
											100	1.73
											200	2.50
											400	3.64
											700	4.97
											900	5.74
											1000	6.10
497001 RG 8/U Type THICKNET DEC 17-000324-00 UL CMP c(UL) 	12 Ga. Solid Bare Copper 1.42 Ω/Mft.	Fluoropolymer		Quad Shield Dual Flexfoil® 94% Tinned Copper Braid + Dual Flexfoil® 94% Tinned Copper Braid 1.52 Ω/Mft.	Orange PVDF		25.00	82.00	84	50	1	0.16
		0.245	6.22		0.375	9.53					5	0.35
											10	0.51
											50	1.19
											100	1.75
											200	2.61
											400	3.97
											700	5.65
											900	6.67
											1000	7.14

RG 11/U Type

Product Construction:

Conductors:

- Copper per ASTM B-3
- Copper-clad steel per ASTM B-869

Insulation/Core:

- Solid and foam polyethylene (PE) designs

Shield:

- Tinned, bare copper or aluminum braid
- Flexfoil® shield

Jacket:





- Premium PVC compound or PE compound

Packaging:

- Please contact Customer Service for packaging and color options

Applications:

- Suitable for RF signal transmission
- Broadcast digital video
- MATV
- CATV†
- Drop cable
- HDTV
- CCTV
- See Coax Connector Cross Reference, pages 192-199

CATALOG NUMBER	AWG SIZE NOM. DCR	INSULATION MATERIAL		SHIELD COVERAGE NOM SHLD DCR	NOMINAL O.D.		NOMINAL CAPACITANCE		VELOCITY OF PROPAGATION, %	NOMINAL IMPEDANCE, Ω	NOMINAL ATTENUATION	
		INCHES	mm		INCHES	mm	pF/ft	pF/m			MHz	dB/100'
C1160 RG 11/U Type JAN-C-17A Type 	18 Ga. (7/26) Tinned Copper 6.1 Ω/Mft.	Solid PE		95% Bare Copper Braid 1.2 Ω/Mft.	Black PVC		20.50	67.26	66	75	1	0.20
		0.285	6.55		0.400	10.16					10	0.70
C5011† RG 11/U Type UL CL2, CATV, CM c(UL) CM 	14 Ga. Solid Bare Copper 2.5 Ω/Mft.	Foam PE		100% Flexfoil® +95% Bare Copper Braid 1.2 Ω/Mft.	Black PVC		16.20	53.15	85	75	1	0.13
		0.280	7.11		0.395	10.03					10	0.40
C5025 RG 11/U Type 	14 Ga. Solid Copper-Clad Steel 11.4 Ω/Mft.	Foam PE		97% Bare Copper Braid 1.2 Ω/Mft.	Black PE		16.20	53.15	83	75	1	0.30
		0.285	7.24		0.405	10.29					10	0.70
C5029 RG 11/U Type UL CL2, CM c(UL) CM 	14 Ga. Solid Copper-Clad Steel 11.4 Ω/Mft.	Foam PE		100% Flexfoil® Bonded +61% Tinned Copper Braid 3.0 Ω/Mft.	Black PVC		16.20	53.15	85	75	1	0.30
		0.280	7.11		0.395	10.03					10	0.70
C5034 RG 11/U Type 1354 	14 Ga. Solid Copper-Clad Steel 11.4 Ω/Mft.	Foam PE		100% Flexfoil® Bonded +40% Aluminum Braid 5.3 Ω/Mft.	Black PVC		16.20	53.15	85	75	1	0.30
		0.280	7.11		0.395	10.03					10	0.70

RG 11/U Type

Product Construction:

Conductor:

- Copper per ASTM B-3
- Copper-clad steel per ASTM B-3

Insulation/Core:

- Foam polyethylene (PE) design
- Foam fluoropolymer (FEP) design

Shield:

- Tinned, bare copper or aluminum braid
- Flexfoil® shield

Jacket:



- Premium PVC compound, Flexguard® or PE compound

Packaging:

- Please contact Customer Service for packaging and color options

Applications:

- Suitable for RF signal transmission
- Broadcast digital video
- MATV
- CATV
- Drop cable
- HDTV
- Direct burial
- See Coax Connector Cross Reference, pages 192-199

CATALOG NUMBER	AWG SIZE NOM. DCR	INSULATION MATERIAL		SHIELD COVERAGE NOM SHLD DCR	NOMINAL O.D.		NOMINAL CAPACITANCE		VELOCITY OF PROPAGATION, %	NOMINAL IMPEDANCE, Ω	NOMINAL ATTENUATION	
		INCHES	mm		INCHES	mm	pF/ft	pF/m			MHz	dB/100'
C5039 RG 11/U Type UL CL2, CATV, CM CSA CMG 1354 	14 Ga. Solid Copper-Clad Steel 11.4 Ω/Mft.	Foam PE		100% Flexfoil® Bonded +60% Aluminum Braid 4.6 Ω/Mft.	Black PVC		16.20	53.15	85	75	1	0.30
		0.280	7.11		0.395	10.03					10	0.70
C5044 RG 11/U Type Quad-Shield UL CL2, CATV, CM CSA CMG 1354 	14 Ga. Solid Copper-Clad Steel 11.4 Ω/Mft.	Foam PE		(2) 100% Flexfoil® 1st Bonded (1) 61% (2) 40% Aluminum Braids 3.4 Ω/Mft.	Black PVC		16.20	53.15	85	75	1	0.30
		0.280	7.11		0.405	10.29					10	0.70
C3528 RG 11/U Type Plenum UL CL2P, CMP c(UL) CMP CATVP 	14 Ga. Solid Copper-Clad Steel 11.4 Ω/Mft.	Fluoropolymer		100% Flexfoil® +60% Aluminum Braids 4.6 Ω/Mft.	PVDF Jacket		16.00	52.50	82	75	1	0.15
		0.280	7.11		0.351	8.92					10	0.47

RG 11/U Type

Product Construction:

Conductor:

- Stranded or solid copper per ASTM B-3
- Copper-clad steel per ASTM B-869

Insulation/Core:

- Foam polyethylene (PE) design
- Foam fluoropolymer (FEP) design

Shield:

- Bare copper or aluminum braid
- Flexfoil® shield

Jacket:



- Premium fluoropolymer compound or premium polyethylene (PE) compound

Packaging:

- Please contact Customer Service for packaging and color options

Applications:

- Suitable for RF signal transmission
- Broadcast/digital video
- MATV
- CATV
- Drop cable
- HDTV
- Direct burial
- See Coax Connector Cross Reference, pages 192-199

CATALOG NUMBER	AWG SIZE NOM. DCR	INSULATION MATERIAL		SHIELD COVERAGE NOM SHLD DCR	NOMINAL O.D.		NOMINAL CAPACITANCE		VELOCITY OF PROPAGATION, %	NOMINAL IMPEDANCE, Ω	NOMINAL ATTENUATION	
		INCHES	mm		INCHES	mm	pF/ft	pF/m			MHz	dB/100'
C3529 RG 11/U Type Quad-Shield Plenum UL CL2P, CMP c(UL) CMP CATVP 	14 Ga. Solid Copper-Clad Steel 11.4 Ω/Mft.	Fluoropolymer		(2) 100% Flexfoil® (1) 60% (2) 40% Aluminum Braids 3.4 Ω/Mft.	PVDF Jacket		16.00	52.50	82	75	1	0.15
		0.280	7.11		0.372	9.45					10	0.47
C5043 RG 11/U Type MoistureGuard™ Direct Burial, Flooded 	14 Ga. Solid Copper-Clad Steel 11.4 Ω/Mft.	Foam PE		100% Flexfoil® Bonded +60% Aluminum Braid w/water block 5.3 Ω/Mft.	Black PE		16.20	53.15	85	75	1	0.30
		0.280	7.11		0.395	10.03					10	0.70
											50	1.09
											100	1.49
											200	2.35
											500	3.94
											1000	6.19
											1450	7.45
											1800	8.30
											2200	9.18

RG 11/U Type Serial Digital Interface (SDI) Precision Cable

Extended-Distance, 75 Ohm High-End Coaxial Cables for Exacting Video, Analog & Digital Applications

Product Construction:

Conductor:

- Copper per ASTM B-3

Insulation/Core:

- Foam polyethylene (PE) design
- Foam fluoropolymer (FEP) design

Shield:

- Bare copper or tinned copper
- Flexfoil® shield

Jacket:





- Premium PVC compound or fluoropolymer

Packaging:

- Please contact Customer Service for packaging and color options

Applications:

- Suitable for RF signal transmission
- Broadcast-grade Serial Digital Interface (SDI)
- Analog/digital video
- MATV
- CATV
- CCTV†
- Drop cable
- HDTV
- See Coax Connector Cross Reference, pages 192-199

CATALOG NUMBER	AWG SIZE NOM. DCR	INSULATION MATERIAL		SHIELD COVERAGE NOM SHLD DCR	NOMINAL O.D.		NOMINAL CAPACITANCE		VELOCITY OF PROPAGATION, %	NOMINAL IMPEDANCE, Ω	NOMINAL ATTENUATION										
		INCHES	mm		INCHES	mm	pF/ft	pF/m			MHz	dB/100'									
395058† RG 11/U Type UL CM c(UL) CMG 	14 Ga. Solid Bare Copper 2.6 Ω/Mft.	Foam PE		95% Bare Copper Braid 1.2 Ω/Mft.	Flame-Retardant PVC		16.20	52.50	84	75	1	0.17									
		0.285	7.24		0.405	10.29					10	0.35	50	0.90	100	1.30	200	1.90	400	2.90	540
395029 RG 11/U Type UL CMR c(UL) CMG 	14 Ga. Solid Bare Copper 2.6 Ω/Mft.	Foam PE		Dual Flexfoil® + 95% Tinned Copper Braid 1.5 Ω/Mft.	Flame-Retardant PVC		16.20	53.10	83	75	1	0.15									
		0.280	7.11		0.405	10.29					3.6	0.28	135	1.62	270	2.31	540	3.29	1500	5.60	2250
495015† RG 11/U Type UL CMP c(UL) CMP 	14 Ga. Solid Bare Copper 2.6 Ω/Mft.	Fluoropolymer		95% Bare Copper Braid 1.2 Ω/Mft.	PVDF		16.20	52.50	84	75	1	0.17									
		0.280	7.11		0.351	8.92					10	0.35	50	0.90	100	1.30	200	1.90	400	2.90	540
495016† RG 11/U Type UL CMP c(UL) CMP 	14 Ga. Solid Bare Copper 2.6 Ω/Mft.	Fluoropolymer		Dual Flexfoil® + 60% AL Braid 3.0 Ω/Mft.	PVDF		16.20	53.10	84	75	1	0.15									
		0.280	7.11		0.351	8.92					10	0.40	50	1.00	100	1.50	200	2.20	400	3.30	540
495027 RG 11/U Type UL CMP c(UL) CMP 	14 Ga. Solid Bare Copper 2.6 Ω/Mft.	Fluoropolymer		Dual Flexfoil® + 95% Tinned Copper Braid Shield 1.5 Ω/Mft.	PVDF		16.20	53.10	84	75	1	0.12									
		0.280	7.11		0.348	8.84					3.6	0.24	135	1.63	270	2.49	540	3.89	1500	7.88	2250

RG 58/U Type

Product Construction:

Conductors:

- Copper per ASTM B-3
- Tinned copper per ASTM B-33

Insulation/Core:

- Solid and foam polyethylene (PE) designs
- Solid and foam fluoropolymer (FEP) design

Shield:

- Tinned copper braid

Jacket:







- Premium PVC compound

Packaging:

- Please contact Customer Service for packaging and color options

Applications:

- Suitable for RF signal transmission
- Broadcast
- LAN & data transmission
- See Coax Connector Cross Reference, pages 192-199

CATALOG NUMBER	AWG SIZE NOM. DCR	INSULATION MATERIAL		SHIELD COVERAGE NOM SHLD DCR	NOMINAL O.D.		NOMINAL CAPACITANCE		VELOCITY OF PROPAGATION, %	NOMINAL IMPEDANCE, Ω	NOMINAL ATTENUATION	
		INCHES	mm		INCHES	mm	pF/ft	pF/m			MHz	dB/100'
C1117 RG 58/U Type 	20 Ga. Solid Bare Copper 10.1 Ω/Mft.	Solid PE		70% Tinned Copper Braid 6.0 Ω/Mft.	Black PVC		28.50	93.51	66	53	1	0.40
		0.116	2.95		0.195	4.95					10	1.20
C1155 RG 58 C/U Type MIL-C-17G Type 	20 Ga. (19/.0071) Tinned Copper 10.8 Ω/Mft.	Solid PE		95% Tinned Copper Braid 4.3 Ω/Mft.	Non-Contaminating Black PVC		30.80	101.05	66	50	1	0.42
		0.116	2.95		0.195	4.95					10	1.50
C1166 RG 58/U Type JAN-C-17A Type 1354 	20 Ga. Solid Bare Copper 10.1 Ω/Mft.	Solid PE		95% Tinned Copper Braid 4.3 Ω/Mft.	Black PVC		30.00	98.43	66	50	1	0.40
		0.116	2.95		0.195	4.95					10	1.20
C1178 RG 58A/U Type JAN-C-17A Type 1354 	20 Ga. (19/.0071) Tinned Copper 10.8 Ω/Mft.	Solid PE		95% Tinned Copper Braid 4.3 Ω/Mft.	Black PVC		31.80	104.34	66	50	1	0.42
		0.116	2.95		0.195	4.95					10	1.50
C1188 RG 58 A/U Type UL CL2, CM CSA CMG 1354 	20 Ga. (19/32) Tinned Copper 9.5 Ω/Mft.	Foam PE		95% Tinned Copper Braid 4.3 Ω/Mft.	Black PVC		26.00	85.31	78	50	1	0.45
		0.114	2.90		0.195	4.95					10	1.42
C3519 RG 58/U Type Plenum UL CL2P, CMP c(UL) CMP 	19 Ga. Solid Bare Copper 8.1 Ω/Mft.	Fluoropolymer		95% Tinned Copper Braid 2.9 Ω/Mft.	Flexguard® PVC Natural		25.00	82.00	82	50	1	0.40
		0.102	2.59		0.161	4.09					10	1.30

RG 59/U Type

Product Construction:

Conductors:

- Copper per ASTM B-3
- Copper-clad steel per ASTM B-869
- Twisted pair color code: black and red

Insulation/Core:

- Solid and cellular polyethylene (PE) designs or foam fluoropolymer (FEP) design

Shield:

- Bare copper braid

Jacket:







- Premium PVC compound or PE compound

Packaging:

- Please contact Customer Service for packaging and color options

Applications:

- Suitable for RF signal transmission
- CATV
- MATV
- CCTV†
- Local Area Network
- Digital video
- Monitor/VDT display
- See Coax Connector Cross Reference, pages 192-199

CATALOG NUMBER	AWG SIZE NOM. DCR	INSULATION MATERIAL		SHIELD COVERAGE NOM SHLD DCR	NOMINAL O.D.		NOMINAL CAPACITANCE		VELOCITY OF PROPAGATION, %	NOMINAL IMPEDANCE, Ω	NOMINAL ATTENUATION												
		INCHES	mm		INCHES	mm	pF/ft	pF/m			MHz	dB/100'											
C1102 RG 59/U Type 	20 Ga. Solid Copper-Clad Steel 45.9 Ω/Mft.	Foam PE		95% Bare Copper Braid 3.5 Ω/Mft.	Black PE		17.30	56.76	82	75	1	0.26											
		0.146	3.71		0.242	6.15					10	0.82	50	1.80	100	2.60	200	3.70	500	6.00	1000	8.80	1450
C1104 RG 59/U Type UL 1354 	22 Ga. Solid Copper-Clad Steel 73.4 Ω/Mft.	Solid PE		95% Bare Copper Braid 2.6 Ω/Mft.	Black PVC		20.50	67.26	66	73	1	0.41											
		0.146	3.71		0.242	6.15					10	0.99	50	2.38	100	3.49	200	5.09	500	8.43	1000	13.03	1450
C1135 RG 59/U Type UL CL2, CATV, CM CSA CMG UL 1354 	22 Ga. Solid Copper-Clad Steel 73.4 Ω/Mft.	Foam PE		95% Bare Copper Braid 2.6 Ω/Mft.	Black PVC		16.30	53.48	78	80	1	0.42											
		0.146	3.71		0.242	6.15					10	0.92	50	2.10	100	2.90	200	4.10	500	6.60	1000	9.30	1450
C1103† RG 59/U Type UL CL2, CATV, CM CSA CMG UL 1354 	22 Ga. (7/30) Bare Copper 14.8 Ω/Mft.	Foam PE		95% Bare Copper Braid 2.6 Ω/Mft.	Black PVC		17.00	55.78	78	76	1	0.26											
		0.146	3.71		0.242	6.15					10	0.91	50	2.09	100	3.00	200	4.33	500	7.03	1000	10.64	1450
C1142† RG 59/U Type UL CL2, CATV, CM CSA CMG UL 1354 	20 Ga. Solid Bare Copper 10.1 Ω/Mft.	Foam PE		95% Bare Copper Braid 2.6 Ω/Mft.	Black PVC		16.20	53.15	78	71	1	0.25											
		0.146	3.71		0.234	5.94					10	0.78	50	1.97	100	2.79	200	3.97	500	6.35	1000	9.15	1450
C1106 RG 59B/U Type MIL-C-17D Type UL 1354 	23 Ga. Solid Copper-Clad Steel 68.5 Ω/Mft.	Solid PE		95% Bare Copper Braid 2.6 Ω/Mft.	Non-Contaminating Black PVC		21.00	68.90	66	73	1	0.44											
		0.146	3.71		0.242	6.15					10	1.02	50	2.44	100	3.55	200	5.18	500	8.59	1000	13.56	1450
C8030† RG 59/U Type +18 AWG Unshielded Pair UL CMP c(UL) CMP 	20 AWG Solid BC Coax 18 AWG (7/26) Unshielded Pair	Fluoropolymer		95% Bare Copper Braid	Natural PVC		16.30	53.48	83	75	1	0.78											
		0.135	3.43		0.200	5.08					10	1.90	50	1.98	100	2.80	200	4.10	500	6.82	1000	9.64	
		PVC		Unshielded Pair	X	X					0.383	9.73	1000										

RG 59/U Type

Product Construction:

Conductors:

- Copper per ASTM B-3
- Copper-clad steel per ASTM B-869
- Twisted pair color code: black and red

Insulation/Core:

- Solid and foam polyethylene (PE) designs

Shield:

- Tinned, bare copper or aluminum braid
- Flexfoil® shield

Jacket:



- Premium PVC compound

Packaging:

- Please contact Customer Service for packaging and color options

Applications:

- Suitable for RF signal transmission
- MATV
- CATV
- CCTV†
- Local Area Network
- Monitor/VDT display
- Analog video
- Digital video
- See Coax Connector Cross Reference, pages 192-199

CATALOG NUMBER	AWG SIZE NOM. DCR	INSULATION MATERIAL		SHIELD COVERAGE NOM SHLD DCR	NOMINAL O.D.		NOMINAL CAPACITANCE		VELOCITY OF PROPAGATION, %	NOMINAL IMPEDANCE, Ω	NOMINAL ATTENUATION	
		INCHES	mm		INCHES	mm	pF/ft	pF/m			MHz	dB/100'
C1110 RG 59/U Type 	22 Ga. Solid Copper-Clad Steel 73.4 Ω/Mft.	Solid PE		70% Bare Copper Braid 4.5 Ω/Mft.	Black PVC		22.00	72.18	66	73	1	0.41
		0.146	3.71		0.242	6.15					10	0.99
C1112 RG 59/U Type 	22 Ga. Solid Copper-Clad Steel 73.4 Ω/Mft.	Foam PE		70% Bare Copper Braid 4.5 Ω/Mft.	Black PVC		16.30	53.48	78	80	1	0.42
		0.146	3.71		0.242	6.15					10	0.92
C8025† RG 59/U Type +22 AWG Shielded Pair UL CL2, CATV, CM c(UL) CM 	22 AWG (7/30) Bare Copper Coax 22 AWG (7/30) Shielded Pair	Foam PE		95% Bare Copper Braid	Black PVC		17.00	57.78	78	76	1	0.26
		0.144	3.66		0.242 X	6.147 X					10	0.91
		Premium PVC		100% Flexfoil® Al/PP Shielded	0.445	11.30					100	3.00
		0.013	0.33								200	4.33
											500	7.03
											1000	10.64

RG 59/U Type

Product Construction:

Conductors:

- Copper-clad steel per ASTM B-869

Insulation/Core:

- Foam polyethylene (PE) design

Shield:

- Aluminum braid
- Flexfoil® shield

Jacket:





- Premium PVC compound

Packaging:

- Please contact Customer Service for packaging and color options

Applications:

- Suitable for RF signal transmission
- CATV
- MATV
- Drop cable
- Local Area Network
- Monitor/VDT display
- See Coax Connector Cross Reference, pages 192-199

CATALOG NUMBER	AWG SIZE NOM. DCR	INSULATION MATERIAL		SHIELD COVERAGE NOM SHLD DCR	NOMINAL O.D.		NOMINAL CAPACITANCE		VELOCITY OF PROPAGATION, %	NOMINAL IMPEDANCE, Ω	NOMINAL ATTENUATION												
		INCHES	mm		INCHES	mm	pF/ft	pF/m			MHz	dB/100'											
C5770 RG 59/U Type UL CL2, CATV, CM CSA CMG 1354 	22 Ga. Solid Copper-Clad Steel 73.4 Ω/Mft.	Foam PE		100% Flexfoil® Bonded + 40% Aluminum Braid 11.0 Ω/Mft.	Black PVC		16.00	52.50	78	80	1	0.50											
		0.144	3.66		0.231	5.87					10	1.00	50	2.30	100	3.30	200	4.10	500	6.50	1000	9.40	1450
C5780 RG 59/U Type MATV UL CL2, CATV, CM CSA CMG 1354 	20 Ga. Solid Copper-Clad Steel 45.9 Ω/Mft.	Foam PE		100% Flexfoil® Bonded + 40% Aluminum Braid 11.0 Ω/Mft.	Black PVC		16.20	53.15	85	75	1	0.60											
		0.144	3.66		0.234	5.94					10	1.20	50	1.95	100	2.70	200	3.70	500	5.70	1000	8.12	1450
C5830 RG 59/U Type Tri-Shield UL CL2, CATV, CM c(UL) CM 	20 Ga. Solid Copper-Clad Steel 45.9 Ω/Mft.	Foam PE		100% Flexfoil® Bonded + 95% Aluminum Braid + 100% Flexfoil® 3.0 Ω/Mft.	Black PVC		16.20	53.15	85	75	1	0.60											
		0.144	3.66		0.242	6.15					10	1.20	50	1.95	100	2.70	200	3.70	500	5.70	1000	8.12	1450
C5784 RG 59/U Type Quad-Shield UL CL2, CATV, CM CSA CMG 1354 	20 Ga. Solid Copper-Clad Steel 45.9 Ω/Mft.	Foam PE		100% Flexfoil® 1st Bonded (1) 67% (2) 46% Aluminum Braids 4.1 Ω/Mft.	Black PVC		16.20	53.15	85	75	1	0.60											
		0.144	3.66		0.270	6.86					10	1.20	50	1.95	100	2.70	200	3.70	500	5.70	1000	8.12	1450

RG 59/U Type

Product Construction:

Conductors:

- Copper-clad steel per ASTM B-869
- Copper per ASTM B-3
- Twisted pair color code: black and red

Insulation/Core:

- Foam polyethylene (PE) design

Shield:

- Bare copper or aluminum braid
- Flexfoil® shield

Jacket:





- Premium PVC compound

Packaging:

- Please contact Customer Service for packaging and color options

Applications:

- Suitable for RF signal transmission
- MATV
- CATV
- CCTV†
- Local Area Network
- Monitor/VDT display
- Direct burial
- See Coax Connector Cross Reference, pages 192-199

CATALOG NUMBER	AWG SIZE NOM. DCR	INSULATION MATERIAL		SHIELD COVERAGE NOM SHLD DCR	NOMINAL O.D.		NOMINAL CAPACITANCE		VELOCITY OF PROPAGATION, %	NOMINAL IMPEDANCE, Ω	NOMINAL ATTENUATION	
		INCHES	mm		INCHES	mm	pF/ft	pF/m			MHz	dB/100'
C3526 RG 59/U Type Plenum UL CL2P, CMP c(UL) CMP 	20 Ga. Solid Copper-Clad Steel 45.9 Ω/Mft.	Fluoropolymer		100% Flexfoil® +65% Aluminum Braid 10.7 Ω/Mft.	Flexguard® Natural		16.00	52.50	84	75	1	0.34
		0.135	3.429		0.202	5.13					10	1.07
C3527 RG 59/U Type Quad-Shield Plenum UL CL2P, CMP c(UL) CMP 	20 Ga. Solid Copper-Clad Steel 45.9 Ω/Mft.	Fluoropolymer		(2) 100% Flexfoil® (1) 60% Aluminum Braid 6.3 Ω/Mft.	Flexguard® Natural		16.00	52.50	84	75	1	0.34
		0.135	3.429		0.235	5.97					10	1.07
C3500 RG 59/U Type Plenum UL CL2P, CMP c(UL) CMP 	20 Ga. Solid Copper-Clad Steel 45.9 Ω/Mft.	Fluoropolymer		95% Bare Copper Braid 1.9 Ω/Mft.	Flexguard® PVC Natural		16.50	54.14	83	75	1	0.78
		0.145	3.68		0.201	5.11					10	1.90
C8027† RG 59/U Type +18 AWG Shielded Pair UL CL2, CATV, CM c(UL) CM 	22 AWG (7/30) Bare Copper Coax 18 AWG (16/30) Shielded Pair	Foam PE		95% Bare Copper Braid	Black PVC		17.00	55.78	78	76	1	0.26
		0.144	3.66		0.242	6.15					10	0.91
		Premium PVC		125% Flexfoil® Al/PP Shielded	X	X					100	3.00
		0.016	0.41		0.480	12.19					200	4.33
C8028† RG 59/U Type +18 AWG Unshielded Pair UL CL2, CATV, CM c(UL) CM 	20 AWG Solid Bare Copper Coax 18 AWG (7/26) Unshielded Pair	Foam PE		95% Bare Copper Braid	Black PVC		16.20	53.15	78	71	1	0.25
		0.144	3.66		0.238	6.05					10	0.78
		Premium PVC		Unshielded Pair	X	X					100	1.97
		0.010	0.25		0.440	11.18					200	2.70

RG 59/U Precision & Miniature Cable

75 Ohm High-End Coaxial Cables for Video, Analog and Digital Applications

Product Construction:

Conductors:

- Copper-clad steel per ASTM B-869
- Copper per ASTM B-3

Insulation/Core:

- Solid polyethylene (PE) designs
- Foam fluoropolymer (FEP) design

Shield:

- Bare or tinned copper, aluminum braid
- Flexfoil® shield

Jacket:



- Premium PVC compound

Packaging:

- Please contact Customer Service for packaging and color options

Applications:

- Suitable for RF signal transmission
- Broadcast-grade
- MATV
- CATV
- CCTV†
- Precision video–analog/digital
- See Coax Connector Cross Reference, pages 192-199

CATALOG NUMBER	AWG SIZE NOM. DCR	INSULATION MATERIAL		SHIELD COVERAGE NOM SHLD DCR	NOMINAL O.D.		NOMINAL CAPACITANCE		VELOCITY OF PROPAGATION, %	NOMINAL IMPEDANCE, Ω	NOMINAL ATTENUATION	
		INCHES	mm		INCHES	mm	pF/ft	pF/m			MHz	dB/100'
C1158 RG 59/U Type Miniature Type  1354	27 Ga. (7/35) Stranded Copper-Clad Steel 120.0 Ω/Mft.	Solid PE		93% Tinned Copper Braid 6.5 Ω/Mft.	Black PVC		20.50	67.26	66	75	1	1.20
		0.100	2.54		0.150	3.81					10	2.40
495028† RG 59/U Type UL CMP c(UL) CMP 	20 Ga. Solid Bare Copper 10.5 Ω/Mft.	Fluoropolymer		95% Bare Copper Braid Shield 2.7 Ω/Mft.	Plenum PVC		16.00	52.50	84	75	1	0.24
		0.139	3.43		0.197	5.00					10	1.41
											50	1.83
											100	2.64
						200	3.84					
						400	5.64					

RG 59 Serial Digital Interface Cable

75 Ohm High-End Coaxial Cables for Video, Analog & Digital Applications

Product Construction:

Conductors:

- Copper per ASTM B-3

Insulation/Core:

- Foam polyethylene (PE) designs
- Foam fluoropolymer (FEP) design

Shield:

- Tinned copper braid
- Flexfoil® shield

Jacket:



- Premium PVC compound

Packaging:

- Please contact Customer Service for packaging and color options

Applications:

- Suitable for RF signal transmission
- Broadcast-grade
- MATV
- CATV
- Precision video-analog/digital
- Serial digital interface cable (SDI)
- See Coax Connector Cross Reference, pages 192-199

CATALOG NUMBER	AWG SIZE NOM. DCR	INSULATION MATERIAL		SHIELD COVERAGE NOM SHLD DCR	NOMINAL O.D.		NOMINAL CAPACITANCE		VELOCITY OF PROPAGATION, %	NOMINAL IMPEDANCE, Ω	NOMINAL ATTENUATION		
		INCHES	mm		INCHES	mm	pF/ft	pF/m			MHz	dB/100'	
395025 RG 59/U Type UL CMR c(UL) CMG 	20 Ga. Solid Bare Copper 10.5 Ω/Mft.	Foam PE		Bi-Metal Foil +95% Tinned Copper Braid Shield 3.5 Ω/Mft.	Flame-Retardant PVC		16.30	53.40	83	75	1	0.29	
		0.146	3.71		0.242	6.15					135	2.70	
495023 RG 59/U Type UL CMP c(UL) CMP 	20 Ga. Solid Bare Copper 10.5 Ω/Mft.	Fluoropolymer		Bi-Metal Foil +95% Tinned Copper Braid Shield 3.2 Ω/Mft.	Plenum PVC		16.10	53.00	84	75	1	0.29	
		0.135	3.43		0.199	5.05					10	1.03	
												50	1.88
												100	2.50
												200	3.85
												400	5.53
												540	6.40
												1000	8.56
												2250	17.50
												3000	21.90

RG 59/U (RGB) Multi-Channel Digital/Precision Cable

75 Ohm High-End Coaxial Cables for Video, Analog & Monitor Applications

Product Construction:

Conductors:

- Solid bare copper per ASTM B-3

Insulation/Core:

- Foam polyethylene (PE) design

Shield:

- Tinned copper braid
- Flexfoil® shield

Jacket:

- Outer jacket: matte finish thermoplastic elastomer (TPE)
- Inner jacket: flame-retardant PVC

Packaging:





- Please contact Customer Service for packaging and color options

Applications:



- Suitable for RF signal transmission
- Broadcast
- HDTV
- Video-analog/digital
- Monitor applications
- See Coax Connector Cross Reference, pages 192-199

CATALOG NUMBER	AWG SIZE NOM. DCR	INSULATION MATERIAL		SHIELD COVERAGE NOM SHLD DCR	NOMINAL O.D.		NOMINAL CAPACITANCE		VELOCITY OF PROPAGATION, %	NOMINAL IMPEDANCE, Ω	NOMINAL ATTENUATION	
		INCHES	mm		INCHES	mm	pF/ft	pF/m			MHz	dB/100'

RG 59/U SERIAL DIGITAL INTERFACE (SDI), PRECISION COAX, RISER RATED

395025-3 RG 59/U Type UL CMR c(UL) CMG 	20 Ga. 3/Cond. Solid Bare Copper 10.5 Ω/Mft.	Foam PE		Bi-Metal Foil +95% Tinned Copper Braid Shield 3.5 Ω/Mft.	Inner: Flame-Retardant PVC Outer: TPE Matte		16.30	52.40	83	75	1	0.29
		0.146	3.71		71.5	2.10						
395025-4 RG 59/U Type UL CMR c(UL) CMG 	20 Ga. 4/Cond. Solid Bare Copper 10.5 Ω/Mft.	Foam PE		Bi-Metal Foil +95% Tinned Copper Braid Shield 3.5 Ω/Mft.	Inner: Flame-Retardant PVC Outer: TPE Matte		16.30	52.40	83	75	1	0.29
		0.146	3.71		71.5	2.10						
395025-5 RG 59/U Type UL CMR c(UL) CMG 	20 Ga. 5/Cond. Solid Bare Copper 10.5 Ω/Mft.	Foam PE		Bi-Metal Foil +95% Tinned Copper Braid Shield 3.5 Ω/Mft.	Inner: Flame-Retardant PVC Outer: TPE Matte		16.30	52.40	83	75	1	0.29
		0.146	3.71		71.5	2.10						
395025-10 RG 59/U Type UL CMR c(UL) CMG 	20 Ga. 10/Cond. Solid Bare Copper 10.5 Ω/Mft.	Foam PE		Bi-Metal Foil +95% Tinned Copper Braid Shield 3.5 Ω/Mft.	Inner: Flame-Retardant PVC Outer: TPE Matte		16.30	52.40	83	75	1	0.29
		0.146	3.71		71.5	2.10						

RG 59/U MINI SERIAL DIGITAL INTERFACE (SDI), PRECISION COAX, RISER RATED

395031-3 RG 59/U Type UL CMR c(UL) CMG 	23 Ga. 3/Cond. Solid Bare Copper 20.1 Ω/Mft.	Foam PE		Bi-Metal Foil +95% Tinned Copper Braid Shield 7.6 Ω/Mft.	Inner: Flame-Retardant PVC Outer: TPE Matte		16.50	54.10	83	75	1	0.39
		0.102	2.59		71.5	3.06						
395031-5 RG 59/U Type UL CMR c(UL) CMG 	23 Ga. 5/Cond. Solid Bare Copper 20.1 Ω/Mft.	Foam PE		Bi-Metal Foil +95% Tinned Copper Braid Shield 7.6 Ω/Mft.	Inner: Flame-Retardant PVC Outer: TPE Matte		16.50	54.10	83	75	1	0.39
		0.102	2.59		71.5	3.06						

RG 59/U (RGB) Miniature Multi-Channel Precision Cable

75 Ohm High-End Coaxial Cables for Video, Analog & Monitor Applications

Product Construction:

Conductors:

- Solid bare copper per ASTM B-3

Insulation/Core:

- Foam polyethylene (PE) design

Shield:

- Tinned copper braid
- Flexfoil® shield

Jacket:



- Outer jacket: matte finish thermoplastic elastomer (TPE)
- Inner jacket: flame-retardant PVC

Packaging:

- Please contact Customer Service for packaging and color options

Applications:

- Suitable for RF signal transmission
- Broadcast
- HDTV
- Video-analog/digital
- Monitor applications
- See Coax Connector Cross Reference, pages 192-199

CATALOG NUMBER	AWG SIZE NOM. DCR	INSULATION MATERIAL		SHIELD COVERAGE NOM SHLD DCR	NOMINAL O.D.		NOMINAL CAPACITANCE		VELOCITY OF PROPAGATION, %	NOMINAL IMPEDANCE, Ω	NOMINAL ATTENUATION										
		INCHES	mm		INCHES	mm	pF/ft	pF/m			MHz	dB/100'									
RG 59/U (RGB) RISER RATED																					
395035-3 RG 59/U Type UL CMR c(UL) CMG 	26 Ga. 3/Cond. Stranded (7/34) Bare Copper 39.7 Ω/Mft.	Foam PE		Bi-Metal Foil +95% Tinned Copper Braid Shield 8.6 Ω/Mft.	Inner: Flame-Retardant PVC Outer: TPE Matte		17.30	56.74	78	75	1	0.56									
		0.089	2.26		0.435	11.05					10	1.48	50	3.20	100	5.18	200	6.95	400	9.36	540
395035-4 RG 59/U Type UL CMR c(UL) CMG 	26 Ga. 4/Cond. Stranded (7/34) Bare Copper 39.7 Ω/Mft.	Foam PE		Bi-Metal Foil +95% Tinned Copper Braid Shield 8.6 Ω/Mft.	Inner: Flame-Retardant PVC Outer: TPE Matte		17.30	56.74	78	75	1	0.56									
		0.089	2.26		0.460	11.70					10	1.48	50	3.20	100	5.18	200	6.95	400	9.36	540
395035-5 RG 59/U Type UL CMR c(UL) CMG 	26 Ga. 5/Cond. Stranded (7/34) Bare Copper 39.7 Ω/Mft.	Foam PE		Bi-Metal Foil +95% Tinned Copper Braid Shield 8.6 Ω/Mft.	Inner: Flame-Retardant PVC Outer: TPE Matte		17.30	56.74	78	75	1	0.56									
		0.089	2.26		0.480	12.19					10	1.48	50	3.20	100	5.18	200	6.95	400	9.36	540

RG 62/U Type

Product Construction:

Conductors:

- Copper-clad steel per ASTM B-869

Insulation/Core:

- Semi-solid polyethylene (PE) design
- Foam fluoropolymer (FEP) design

Shield:

- Bare copper braid

Jacket:



- Premium PVC compound

Packaging:

- Please contact Customer Service for packaging and color options

Applications:

- Suitable for RF signal transmission
- Computer/networks
- See Coax Connector Cross Reference, pages 192-199

CATALOG NUMBER	AWG SIZE NOM. DCR	INSULATION MATERIAL		SHIELD COVERAGE NOM SHLD DCR	NOMINAL O.D.		NOMINAL CAPACITANCE		VELOCITY OF PROPAGATION, %	NOMINAL IMPEDANCE, Ω	NOMINAL ATTENUATION	
		INCHES	mm		INCHES	mm	pF/ft	pF/m			MHz	dB/100'
C1162 RG 62A/U Type MIL-C-17G Type  1354	22 Ga. Solid Copper-Clad Steel 73.4 Ω/Mft.	Semi-Solid PE		95% Bare Copper Braid 2.6 Ω/Mft.	Non-Contaminating Black PVC		13.60	44.62	84	93	1	0.38
		0.146	3.71		0.242	6.15					10	0.85
C1164 RG 62/U Type Computer Cable JAN-C-17A Type UL CL2, CM CSA CMG  1354	22 Ga. Solid Copper-Clad Steel 73.4 Ω/Mft.	Semi-Solid PE		95% Bare Copper Braid 2.6 Ω/Mft.	Black PVC		13.60	44.62	84	93	1	0.38
		0.146	3.66		0.242	6.15					10	0.85
C3520 RG 62/U Type Plenum UL CL2P, CMP c(UL) CMP 	22 Ga. Solid Copper-Clad Steel 54.7 Ω/Mft.	Fluoropolymer		95% Bare Copper Braid 1.9 Ω/Mft.	Flexguard® PVC Natural		13.00	42.65	84	93	1	0.30
		0.145	3.56		0.201	5.11					10	0.90
											100	2.70
											200	3.80
											500	5.90
											1000	8.70
											1000	8.34

RG 174/U Type

Product Construction:

Conductors:

- Copper-clad steel per ASTM B-869

Insulation/Core:

- Solid polyethylene (PE) design

Shield:

- Tinned or bare copper braid

Jacket:



- Premium PVC compound

Packaging:

- Please contact Customer Service for packaging and color options

Applications:

- Suitable for RF signal transmission
- See Coax Connector Cross Reference, pages 192-199

CATALOG NUMBER	AWG SIZE NOM. DCR	INSULATION MATERIAL		SHIELD COVERAGE NOM SHLD DCR	NOMINAL O.D.		NOMINAL CAPACITANCE		VELOCITY OF PROPAGATION, %	NOMINAL IMPEDANCE, Ω	NOMINAL ATTENUATION	
		INCHES	mm		INCHES	mm	pF/ft	pF/m			MHz	dB/100'
C1156 RG 174/U Type 	26 Ga. (7/34) Copper-Clad Steel 97.0 Ω/Mft.	Solid PE		88% Tinned Copper Braid 10.3 Ω/Mft.	Black PVC		30.80	101.05	66	50	1	1.90
		0.060	1.52		0.103	2.62					10	3.30
											50	5.80
											100	8.40
											200	12.50
											500	21.21
											1000	34.00
395027 RG 174/U 	26 Ga. (7/34) Copper-Clad Steel 93.0 Ω/Mft.	Solid PE		88% Tinned Copper Braid Shield 10.7 Ω/Mft.	Black PVC		30.80	101.05	66	50	1	1.90
		0.059	0.139		0.110	2.82					10	3.30
											50	5.80
											100	8.40
											200	12.50
											500	21.21
											1000	34.00

RG 213/U Type

Product Construction:

Conductors:

- Copper per ASTM B-3

Insulation/Core:

- Solid polyethylene (PE) design

Shield:

- Bare copper braid

Jacket:

- Premium non-contaminating black PVC

Packaging:

- Please contact Customer Service for packaging and color options

Applications:

- Suitable for RF signal transmission
- See Coax Connector Cross Reference, pages 192-199

CATALOG NUMBER	AWG SIZE NOM. DCR	INSULATION MATERIAL		SHIELD COVERAGE NOM SHLD DCR	NOMINAL O.D.		NOMINAL CAPACITANCE		VELOCITY OF PROPAGATION, %	NOMINAL IMPEDANCE, Ω	NOMINAL ATTENUATION	
		INCHES	mm		INCHES	mm	pF/ft	pF/m			MHz	dB/100'
C1176A RG 213/U Type MIL-C-17G Type 1354 	13 Ga. (7/21) Bare Copper 1.7 Ω/Mft.	Solid PE 0.285 7.24		95% Bare Copper Braid 1.2 Ω/Mft.	Black PVC		30.80 101.05	66	50	1 10 50 100 200 500 1000	0.18 0.62 1.50 2.10 3.00 5.03 8.20	
					0.405	10.29						

Twinaxial Cables

Product Construction:

Conductors:

- Copper per ASTM B-3
- Tinned copper per ASTM B-33

Insulation/Core:

- Solid and foam polyethylene (PE) designs
- Lo-Cap® polypropylene (PPE) design

Shield:

- Tinned copper braid
- Flexfoil® shield

Jacket:



- Premium PVC compound

Packaging:

- Please contact Customer Service for packaging and color options

Applications:

- Programmable Logic Controllers (PLC)
- Data transmission
- Broadcast
- Computer
- See Coax Connector Cross Reference, pages 192-199

CATALOG NUMBER	AWG SIZE NOM. DCR	INSULATION MATERIAL		SHIELD COVERAGE NOM SHLD DCR	NOMINAL O.D.		NOMINAL CAPACITANCE		VELOCITY OF PROPAGATION, %	NOMINAL IMPEDANCE, Ω	NOMINAL ATTENUATION	
		INCHES	mm		INCHES	mm	pF/ft	pF/m			MHz	dB/100'
C8000 UL CL2  2498 80°C, 300V	20 Ga. (7/28) (1) Tinned Copper, (1) Bare Copper 9.5 Ω/Mft.	Solid PE Coded: Natural, Natural		100% Flexfoil® +90% Tinned Copper Braid 2.5 Ω/Mft.	Black PVC		15.50 50.86	66	100	1 10 50 100 200 400	0.40 1.10 2.50 4.10 6.40 10.20	
		0.022	0.56		0.330	8.38						
C8001 UL CL2, CM  2464 2582 60°C, 300V	20 Ga. (7/28) Tinned Copper 9.5 Ω/Mft.	Solid PE Coded: Natural, Blue		100% Flexfoil® +57% Tinned Copper Braid 4.1 Ω/Mft.	Blue PVC		19.17 62.90	66	78	1 10 50 100 200 400	0.60 2.10 5.00 7.50 11.00 16.00	
		0.020	0.51		0.242	6.15						
C8014  2668 60°C, 30V	22 Ga. (19/34) Tinned Copper 15.0 Ω/Mft.	Lo-Cap® PPE Coded: Black, Yellow		100% Flexfoil® +22 AWG Tinned Copper Drain Wire 6.3 Ω/Mft.	Black PVC		8.80 28.87	78	150	1 10 50 100 200 400	0.40 1.20 2.65 4.30 6.20 8.80	
		0.051	1.30		0.360	9.14						

Fire Alarm/Life Safety Cable

6

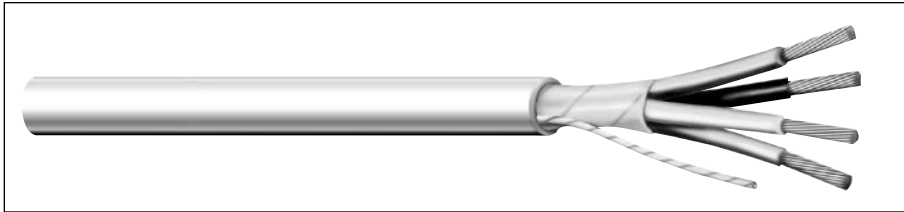

Fire alarm systems have expanded from a rather simple and unsophisticated business configured upon large, electro-mechanical devices to one relying upon the most modern technologies of microprocessor and chip technology.

More and more end users— industrial, commercial as well as consumer—are relying upon these emerging systems to protect both property and life. These systems are only as good as their weakest component, whether that component be a processor or interconnecting wire and cable.

It is General Cable's charter that all products supplied for use in these and any other systems shall be constructed of only the finest available materials, and provide the service and assurance that the end user not only needs, but requires.

Aside from the quality materials used in these designs, specifiers and end users of Carol® Brand wire and cable products have come to expect that these cables are registered and certified with the leading regulatory agencies such as Underwriters Laboratories ... and we haven't let you down!

These designs have proven themselves in the area of fire system security over time; all are fabricated with solid, bare copper conductors and insulations and jackets of premium-grade PVC. Offered both with and without shields, the former to protect these critical circuits from noise, these cables will provide the latest in available technology for the system installer and contractor.

General Cable Carol® Brand products are conveniently packaged in 1000' or 500' lengths to assist the installer.

Index	Page
Alarm and Security Solutions Guide	114-116
Multi-Conductor, Unshielded, Non-Plenum	117
Multi-Conductor, Unshielded, Non-Plenum (CSA)	118
Multi-Conductor, Shielded, Non-Plenum	119
Multi-Conductor, Shielded, Non-Plenum (CSA)	120
Multi-Conductor, Unshielded, Plenum	121-122
Multi-Conductor, Shielded, Plenum	123-124
Mid-Capacitance, Unshielded, Non-Plenum	125
Mid-Capacitance, Shielded, Non-Plenum	126
Mid-Capacitance, Unshielded, Plenum	127
Mid-Capacitance, Shielded, Plenum	128
Multi-Paired, Unshielded, Non-Plenum (CSA)	129

Carol® Brand Alarm & Security Solutions

General Cable's Carol® Brand is the right solution for alarm and security wire and cable. Carol offers as broad an offering as anyone in the industry. Our Alarm and Security Solutions Guide makes it easier to specify and sell the right cables for every application in this ever-growing market.

There are five basic areas where alarm and security cables are used. General Cable has the right product to serve every application, including:

- Access Control
- Video Surveillance/CCTV
- Fire Alarm and Life Safety
- Home Theater and Burglar Alarms
- Data Communications

Our alarm and security cables offer solutions in all these major security applications markets, including:

- Commercial Buildings
- Residential Housing
- Business and Office Campus Environments
- Public Stadiums and Arenas
- Airport, Train, Bus and Other Transportation Hubs
- Schools, Colleges and Universities

Many cables also available in **ARMORED CONSTRUCTIONS** for easy plenum installations

The General Cable Alarm and Security Solutions Guide provides a quick and easy reference tool to identify every Carol® Brand cable for the appropriate alarm and security application. Whatever the security application need calls for, we have a cable that delivers the performance you need.

Access Control



Applications:

- Door Controllers
- Prox Sensors
- Key Pads
- Card Readers
- Gate Access

Cable Solution Description

Cable Solution	Description
4EPL4S*	4 Shielded Elements Overall Jacket Access Control Plenum
4EPL1S*	4 Elements 1 Shielded Overall Jacket Access Control Plenum
4ERS4S**	4 Shielded Elements Overall Jacket Access Control Riser
4ERS1S**	4 Elements 1 Shielded Overall Jacket Access Control Riser
E2002S	22/2 Conductor Shielded Riser
E2004S	22/4 Conductor Shielded Riser
E2006S	22/6 Conductor Shielded Riser
E2008S	22/8 Conductor Shielded Riser
E2010S	22/10 Conductor Shielded Riser
E2012S	22/12 Conductor Shielded Riser
E2102S	22/2 Conductor Shielded Plenum
E2104S	22/4 Conductor Shielded Plenum
E2106S	22/6 Conductor Shielded Plenum
E2108S	22/8 Conductor Shielded Plenum
E2032S	18/2 Conductor Shielded Riser
E2034S	18/4 Conductor Shielded Riser
E2036S	18/6 Conductor Shielded Riser
E2038S	18/8 Conductor Shielded Riser

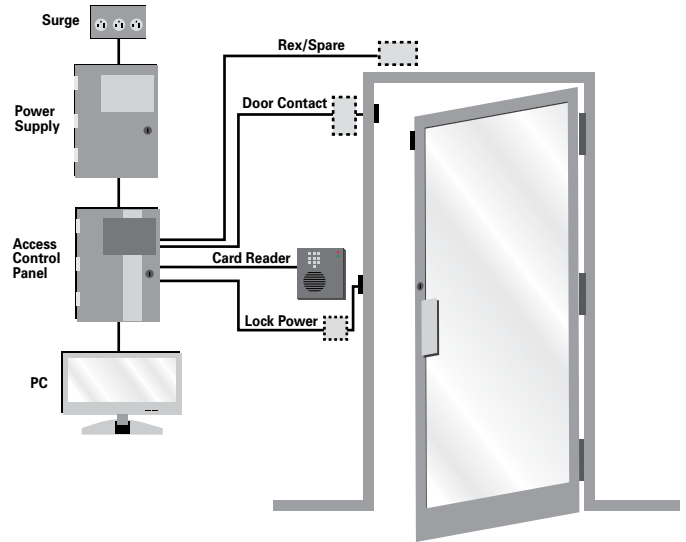

Cable Solution Description

Cable Solution	Description
E2202S	18/2 Conductor Shielded Plenum
E2204S	18/4 Conductor Shielded Plenum
E2206S	18/6 Conductor Shielded Plenum
E2208S	18/8 Conductor Shielded Plenum

Carol® Brand Composite Access Control Cable – Plenum* (3) Multi-Conductors • (1) Multi-Pair • Overall Jacket 60°C 300 Volt (UL) & C(UL) Type CMP

Catalog Number	Overall Nominal OD Inch (mm)	Component No.	Component Descriptions	Conductors Color Code	Component Nominal OD Inch (mm)	Insulation Thickness Inch (mm)
4EPL4S	0.430	1	4 Cond, 18 AWG, Shielded	White, Black, Red, Green	0.180 (4.572)	0.008 (0.2032)
		2	3 Pair, 22 AWG, Shielded	White & Green, Orange & Brown, Red & Black	0.195 (4.93)	0.008 (0.2032)
		3	2 Cond, 22 AWG, Shielded	Red, Black	0.125 (3.175)	0.008 (0.2032)
		4	4 Cond, 22 AWG, Shielded	White, Black, Red, Green	0.145 (3.683)	0.008 (0.2032)
4EPL1S	0.420	1	4 Cond, 18 AWG, Unshielded	White, Black, Red, Green	0.180 (4.572)	0.008 (0.2032)
		2	3 Pair, 22 AWG, Shielded	White & Green, Orange & Brown, Red & Black	0.195 (4.93)	0.008 (0.2032)
		3	2 Cond, 22 AWG, Unshielded	Red, Black	0.125 (3.175)	0.008 (0.2032)
		4	4 Cond, 22 AWG, Unshielded	White, Black, Red, Green	0.145 (3.683)	0.008 (0.2032)

Carol® Brand Composite Access Control Cable – Riser** (3) Multi-Conductors • (1) Multi-Pair • Overall Jacket 60°C 300 Volt (UL) & C(UL) Type CMR

Catalog Number	Overall Nominal OD Inch (mm)	Component No.	Component Descriptions	Conductors Color Code	Component Nominal OD Inch (mm)	Insulation Thickness Inch (mm)
4ERS4S	0.430	1	4 Cond, 18 AWG, Shielded	White, Black, Red, Green	0.180 (4.572)	0.008 (0.2032)
		2	3 Pair, 22 AWG, Shielded	White & Green, Orange & Brown, Red & Black	0.195 (4.93)	0.008 (0.2032)
		3	2 Cond, 22 AWG, Shielded	Red, Black	0.125 (3.175)	0.008 (0.2032)
		4	4 Cond, 22 AWG, Shielded	White, Black, Red, Green	0.145 (3.683)	0.008 (0.2032)
4ERS1S	0.420	1	4 Cond, 18 AWG, Unshielded	White, Black, Red, Green	0.180 (4.572)	0.008 (0.2032)
		2	3 Pair, 22 AWG, Shielded	White & Green, Orange & Brown, Red & Black	0.195 (4.93)	0.008 (0.2032)
		3	2 Cond, 22 AWG, Unshielded	Red, Black	0.125 (3.175)	0.008 (0.2032)
		4	4 Cond, 22 AWG, Unshielded	White, Black, Red, Green	0.145 (3.683)	0.008 (0.2032)

**CAROL®
BRAND**

General Cable

Video Surveillance/CCTV



Applications:
 CCTV
 Satellites
 Digital Video
 Analog Video
 Switchers/Multiplexers
 Digital Recorders

CATV/MATV/DBS RG 59, RG 6 and RG 11 Ratings

Cable Solution	Description
C3521	RG 6/U 18/1 FL + 95% TC CL2P
C3523	RG 6 SBC/Foil/61% TC Braid Plenum
C3524	RG 6 CCS/Foil/60% AL Braid Plenum
C3525	RG 6 CCS/Quad 60/40% AL Braid Plenum
C5761	RG 6 SBC Foil/95% BC Braid CATV/CM
C5775	RG 6 CCS/Foil/60% AL Braid CATV/CM
C5785	RG 6 CCS/Quad 60/40% AL Braid CATV/CM
C5886	RG 6 CCS/Foil/60% AL Braid CATV/CMR
C5889	RG 6 CCS/Quad 60/40% AL Braid CATV/CMR
C3528	RG 11 CCS/Foil/60%/AL Braid CATV/CMP Plenum
C5039	RG 11 CCS/Foil/60%/AL Braid CATV/CM
C5043	RG 11/U CCS Burial FL 60% AL
C5044	RG 11/U CCS Quad Shield CL2/CM
C1135	RG 59/U CCS 95% BC Braid CM
C3500	RG 59 CCS/95% BC Braid Plenum
C3526	RG 59/U CCS AMA/80% AL Braid CLP2/CMP

HDTV/SDI—Interconnect Cables RG 59, RG 6 and RG 11 Ratings

Cable Solution	Description
395011	RG 6 SBC/Foil/95% TC Braid CMR
395014	RG 6/U 18/1 SBC Quad Shield 60%/40% CMR
495025	RG 6/U 18 AWG SBC 95% Dual Foil TC Braid CMP Plenum
395025	RG 59 SBC/Foil/95% TC Braid CMR
395031	RG 59 Single/Miniature/Foil/95% TC Braid CMR
495023	RG 59/U SBC/Foil/95% TC Braid CMP Plenum

Low Skew - 4 Pair UTP Cables for RGB Video

Cable Solution	Description
E3842S	Low Skew 24/4 UTP CMP for RGB Video
E1842S	Low Skew 24/4 UTP CMR for RGB Video
E3843S	Low Skew 23/4 UTP CMP for RGB Video
E1843S	Low Skew 23/4 UTP CMR for RGB Video

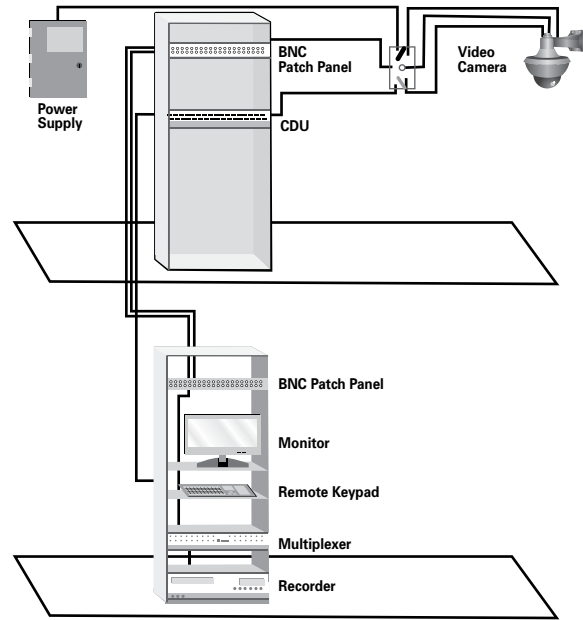

CCTV RG 59 and RG 11 Ratings

Cable Solution	Description
C8029	RG 6 + 18/2 Unshielded CATV/CM
C8031	RG 6/U SBC/95% + 18/2 Unshielded Pair CMP Plenum
495035	RG 6/U 18 AWG SBC 95% BC CMP Plenum
395058	RG 11 SBC/95% BC Braid CM
495015	RG 11 SBC/95% BC Braid CMP Plenum
C1103	RG 59 BC/95% BC Braid CATV/CM
C1142	RG 59 SBC/95% BC Braid CATV/CM
C8025	RG 59/U STR (7/30) BC/95% + 22/2 SH Pair CCTV/CM
C8027	RG 59 + 18/2 Shielded CATV/CM
C8028	RG 59 + 18/2 Unshielded CATV/CM
C8030	RG 59/U SBC/95% + 18/2 Unshielded Pair CCTV Plenum
495028	RG 59 SBC/95% BC Braid CMP Plenum

Fire Alarm and Life Safety



Applications:
 Smoke Detectors
 Strobes/Sirens
 Pull Stations
 Microprocessor/
 Addressable
 Controlled Systems

Cable Solution	Description
E1502S	18/2 Conductor Riser FPLR
E1504S	18/4 Conductor Riser FPLR
E1522S	14/2 Conductor Riser FPLR
E1524S	14/4 Conductor Riser FPLR
E2502S	18/2 Conductor Shielded Riser FPLR
E2504S	18/4 Conductor Shielded Riser FPLR
E2532S	14/2 Conductor Shielded Riser FPLR
E2534S	14/4 Conductor Shielded Riser FPLR
E3502S	18/2 Conductor Plenum FPLP
E3504S	18/4 Conductor Plenum FPLP
E3522S	14/2 Conductor Plenum FPLP
E3524S	14/4 Conductor Plenum FPLP

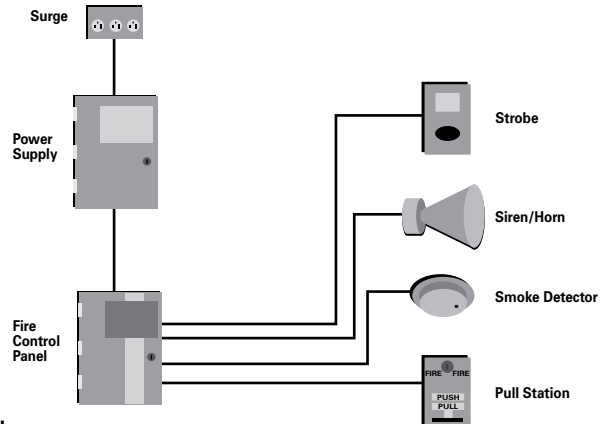

Cable Solution	Description
E3602S	18/2 Conductor Shielded Plenum FPLP
E3604S	18/4 Conductor Shielded Plenum FPLP
E3622S	14/2 Conductor Shielded Plenum FPLP
E3624S	14/4 Conductor Shielded Plenum FPLP

Home Theater and Burglar Alarms



Applications:
Intercoms
PA Systems
Sound Systems
Emergency Phones
Speakers
Burglar Alarms
Home Theater

Cable Solution Description

Cable Solution	Description
E1002S	22/2 Conductor Riser
E1004S	22/4 Conductor Riser
C4408	22/2 Solid Conductor CMR/CMX
C4408ST	22/2 Stranded Conductor CMR/CMX
C4412	22/4 Solid Conductor Solid CMR/CMX
C4412ST	22/4 Stranded Conductor CMR/CMX
C4408.86.XX	22/2 Solid Conductor CM/CMX*
C4408ST.86.XX	22/2 Stranded Conductor CM/CMX*
C4412.86.XX	22/4 Solid Conductor CM/CMX*
C4412ST.86.XX	22/4 Stranded Conductor CM/CMX*
E1006S	22/6 Conductor Riser
E1008S	22/8 Conductor Riser
E1032S	18/2 Conductor Riser
E1034S	18/4 Conductor Riser
E1042S	16/2 Conductor Riser
E1044S	16/4 Conductor Riser
E1052S	14/2 Conductor Riser
E1054S	14/4 Conductor Riser
E1062S	12/2 Conductor Riser
E1064S	12/4 Conductor Riser

*Available Colors for Burglar Alarm Coil Packs
XX= White Gray Green Beige Yellow Dark Blue

Burglar Alarm Cable in 500' Coil Packs*

Oxygen-Free + ETP High-Performance Home Theater Cables

Cable Solution	Description
C1000	Command® Series Twisted Pair Speaker, 22/2, 7x30 Stranding, 500' Reels
C1001	Command Series Twisted Pair Speaker, 20/2, 7x28 Stranding, 500' Reels
C1002	Command Series Twisted Pair Speaker, 18/2, 7x26 Stranding, 500' Reels
C1003	Command Series Twisted Pair Speaker, 16/2, 19x29 Stranding, 500' Reels
C1004	Command Series Twisted Pair Speaker, 14/2, 42x30 Stranding, 500' Reels
C1005	Command Series Twisted Pair Speaker, 12/2, 65x30 Stranding, 500' Reels
C1362	22/2 Conductor Zip (not for inwall use)
C1357	18/2 Conductor Zip (not for inwall use)
C1458	16/2 Conductor Zip CL2
C1461	14/2 Conductor Zip CL2
C1463	12/2 Conductor Zip CL2
C1702	14/2 Command Series Home Grade Speaker
C1703	14/4 Command Series Home Grade Speaker
C1704	16/2 Command Series Home Grade Speaker
C1705	16/4 Command Series Home Grade Speaker
C1800	Command Series "High Def" Speaker Type NEC, 12/2, 105x32 Stranding, 500' Reels
C1801	Command Series "High Def" Speaker Type NEC, 12/4, 105x32 Stranding, 500' Reels
C1802	Command Series "High Def" Speaker Type NEC, 14/2, 105x34 Stranding, 500' Boxes
C1803	Command Series "High Def" Speaker Type NEC, 14/4, 105x34 Stranding, 500' Reels
C1804	Command Series "High Def" Speaker Type NEC, 16/2, 65x34 Stranding, 500' Boxes
C1805	Command Series "High Def" Speaker Type NEC, 16/4, 65x34 Stranding, 500' Boxes
395031X3	23/3 Command Series RGB Cables, Solid BC, Foam PE, Dual Foil + 95% TC Braid
395031X5	23/5 Command Series RGB Cables, Solid BC, Foam PE, Dual Foil + 95% TC Braid

Carol® Brand Helix/Hi-Temp® Data Communications



Applications:
Telephones
Cat 5e and 6
Connections
Networking
Workstations
Video Conferencing
Telco Closets
Home Automation
IP Cameras

Cat 5e Pull-Pac® II

Standard packaging: 1000' Pull-Pac® II

Jacket Color	Pull-Pac® II	
	CMR (Non-Plenum)	CMP (Plenum)
Blue	CR5.30.07	CP5.30.07
White	CR5.30.02	CP5.30.02
Gray	CR5.30.10	CP5.30.10
Green	CR5.30.06	CP5.30.06
Yellow	CR5.30.05	CP5.30.05
Red	CR5.30.03	CP5.30.03

Cat 6 Pull-Pac® II

Standard packaging: 1000' Pull-Pac® II

Jacket Color	Pull-Pac® II	
	CMR (Non-Plenum)	CMP (Plenum)
Blue	CR6.30.07	CP6.30.07
White	CR6.30.02	CP6.30.02
Gray	CR6.30.10	CP6.30.10
Green	CR6.30.06	CP6.30.06
Yellow	CR6.30.05	CP6.30.05
Red	CR6.30.03	CP6.30.03

Cat 5e Spool-Pac®

Standard packaging: 1000' Spool-Pac®

Jacket Color	Spool-Pac®	
	CMR (Non-Plenum)	CMP (Plenum)
Blue	CR5.A3.07	CP5.A3.07
White	CR5.A3.02	CP5.A3.02
Gray	CR5.A3.10	CP5.A3.10
Green	CR5.A3.06	CP5.A3.06
Yellow	CR5.A3.05	CP5.A3.05
Red	CR5.A3.03	CP5.A3.03

Cat 6 Spool-Pac®

Standard packaging: 1000' Spool-Pac®

Jacket Color	Spool-Pac®	
	CMR (Non-Plenum)	CMP (Plenum)
Blue	CR6.A3.07	CP6.A3.07
White	CR6.A3.02	CP6.A3.02
Gray	CR6.A3.10	CP6.A3.10
Green	CR6.A3.06	CP6.A3.06
Yellow	CR6.A3.05	CP6.A3.05
Red	CR6.A3.03	CP6.A3.03

CAROL BRAND

General Cable

Multi-Conductor, Unshielded, Non-Plenum

NEC Type FPLR

Product Construction:

Conductor:

- 22 thru 12 AWG fully annealed solid bare copper per ASTM B-3

Insulation:

- Premium-grade, color-coded S-R PVC
- Color code: See chart below

Jacket:

- Premium-grade, red PVC
- Suitable for use from -20°C to +75°C
- Round constructions have sequential footage markings to facilitate installation
- Includes ripcord on round constructions

Applications:

- Wiring of fire alarms
- Smoke detectors
- Voice communications
- Burglar alarms
- Fire protective circuits
- Suggested voltage rating: 300 volts

Compliances:

- NEC Article 760 Type FPLR (UL: 75°C, 300V)
- California State Fire Marshall Approved
- RoHS Compliant Directive 2002/95/EC
- Designed to meet UL 1666 Flame Test

Packaging:

- Please contact Customer Service for packaging and color options

Color Code Chart

NO. OF COND.	COLOR
1	Black
2	Red
3	Brown
4	Blue
5	Orange
6	Yellow
7	Violet
8	Gray

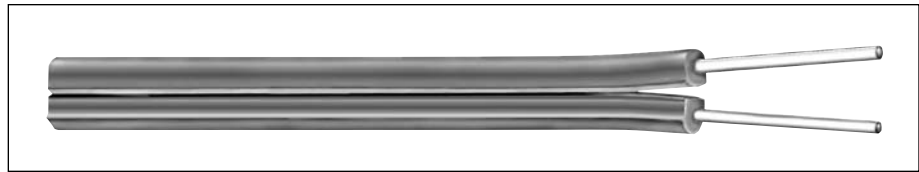

CATALOG NUMBER	NO. OF COND.	AWG SIZE	COND. STRAND	NOM. INSULATION THICKNESS		NOMINAL O.D.	
				INCHES	mm	INCHES	mm
DUPLIX PARALLEL, RIBBED FOR POLARITY							
E2402S	2	18	Solid	0.032	0.81	0.105 x 0.210	2.67 x 5.33
E2404S	2	16	Solid	0.032	0.81	0.115 x 0.230	2.92 x 5.84
E2406S	2	14	Solid	0.032	0.81	0.126 x 0.260	3.20 x 6.60

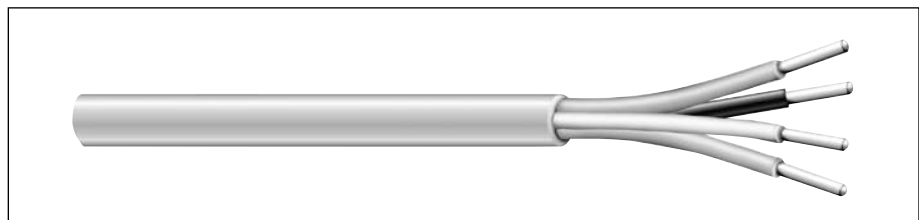

CATALOG NUMBER	NO. OF COND.	AWG SIZE	COND. STRAND	NOM. INSULATION THICKNESS		NOM. JACKET WALL		NOMINAL O.D.	
				INCHES	mm	INCHES	mm	INCHES	mm
22 AWG CONDUCTORS									
E1482S	2	22	Solid	0.010	0.25	0.015	0.38	0.121	3.07
E1484S	4	22	Solid	0.010	0.25	0.015	0.38	0.140	3.56
E1486S	6	22	Solid	0.010	0.25	0.015	0.38	0.168	4.27
18 AWG CONDUCTORS									
E1502S	2	18	Solid	0.010	0.25	0.015	0.38	0.150	3.81
E1503S	3	18	Solid	0.010	0.25	0.015	0.38	0.160	4.06
E1504S	4	18	Solid	0.010	0.25	0.015	0.38	0.175	4.45
E1505S	5	18	Solid	0.010	0.25	0.015	0.38	0.193	4.90
E1506S	6	18	Solid	0.010	0.25	0.015	0.38	0.210	5.33
E1508S	8	18	Solid	0.010	0.25	0.015	0.38	0.230	5.84
16 AWG CONDUCTORS									
E1512S	2	16	Solid	0.010	0.25	0.015	0.38	0.172	4.37
E1514S	4	16	Solid	0.010	0.25	0.015	0.38	0.202	5.13
14 AWG CONDUCTORS									
E1522S	2	14	Solid	0.013	0.33	0.015	0.38	0.210	5.33
E1524S	4	14	Solid	0.013	0.33	0.015	0.38	0.248	6.30
12 AWG CONDUCTORS									
E1532S	2	12	Solid	0.013	0.33	0.015	0.38	0.244	6.20
E1534S	4	12	Solid	0.013	0.33	0.015	0.38	0.288	7.32

Multi-Conductor, Unshielded, Non-Plenum

CSA FAS 105, FPL (UL), NEC Type PLTC



CATALOG NUMBER	NO. OF COND.	AWG SIZE	COND. STRAND	NOM. INSULATION THICKNESS		NOM. JACKET WALL		NOMINAL O.D.	
				INCHES	mm	INCHES	mm	INCHES	mm
C4300A	6	22	Solid	0.012	0.30	0.042	1.07	0.232	5.89
C4301A	15	22	Solid	0.012	0.30	0.042	1.07	0.316	8.03
C4302A	20	22	Solid	0.012	0.30	0.042	1.07	0.346	8.79
C4304A	2	18	Solid	0.015	0.38	0.042	1.07	0.225	5.71
C4305A	3	18	Solid	0.015	0.38	0.042	1.07	0.236	5.99
C4306A	4	18	Solid	0.015	0.38	0.042	1.07	0.255	6.47
C4307A	5	18	Solid	0.015	0.38	0.042	1.07	0.274	6.96
C4308A	6	18	Solid	0.015	0.38	0.042	1.07	0.296	7.52
C4309A	7	18	Solid	0.015	0.38	0.042	1.07	0.296	7.52
C4310A	8	18	Solid	0.015	0.38	0.042	1.07	0.317	8.05
C4312A	9	18	Solid	0.015	0.38	0.042	1.07	0.339	8.61
C4313A	10	18	Solid	0.015	0.38	0.042	1.07	0.366	9.30
C4314A	11	18	Solid	0.015	0.38	0.042	1.07	0.366	9.30
C4315A	15	18	Solid	0.015	0.38	0.053	1.35	0.437	11.10
C4316A	20	18	Solid	0.015	0.38	0.053	1.35	0.480	12.19
C4317A	21	18	Solid	0.015	0.38	0.053	1.35	0.480	12.19
C4318A	30	18	Solid	0.015	0.38	0.053	1.35	0.558	14.17
C4321A	2	16	Solid	0.015	0.38	0.042	1.07	0.246	6.25
C4322A	3	16	Solid	0.015	0.38	0.042	1.07	0.258	6.55
C4323A	4	16	Solid	0.015	0.38	0.042	1.07	0.280	7.11
C4349A	5	16	Solid	0.015	0.38	0.042	1.07	0.302	7.67
C4324A	2	14	Solid	0.015	0.38	0.042	1.07	0.272	6.91
C4325A	3	14	Solid	0.015	0.38	0.042	1.07	0.286	7.26
C4326A	4	14	Solid	0.015	0.38	0.042	1.07	0.311	7.90
C4327A	2	12	Solid	0.020	0.51	0.042	1.07	0.326	8.28

Product Construction:

Conductor:

- 22 thru 12 AWG fully annealed solid bare copper per ASTM B-3

Insulation:

- Premium-grade PVC
- Color code: See page 229 for the CSA Fire Alarm Color Code Chart

Jacket:

- Premium-grade, red PVC; brown as an option
- Temperature range: -20°C to +105°C
- TRU-Mark® print legend contains footage markings from 1000' to 0'

Applications:

- Wiring of fire alarms
- Smoke alarms
- Voice communications
- Burglar alarms
- Fire protective circuits
- Suggested voltage rating: 300 volts

Compliances:

- NEC Article 725 PLTC (UL: 105°C, 300V)
- NEC Article 760 Type FPL (UL: 105°C, 300V)
- CSA FAS 105 (CSA: 105°C, 300V)
- C22.2 No. 208-03 (R2008)
- Designed to meet UL 70,000 BTU Vertical Tray Flame Test
- Passes CSA FT-4 Vertical Flame Test

Packaging:

- Please contact Customer Service for packaging and color options



Multi-Conductor, Shielded, Non-Plenum

NEC Type FPLR

Product Construction:

Conductor:

- 22 thru 12 AWG fully annealed solid bare copper per ASTM B-3

Insulation:

- Premium-grade, color-coded S-R PVC
- Color code: See chart below

Shield:

- Overall Flexfoil® polyester supported aluminum foil
- Stranded tinned copper drain wire

Jacket:

- Premium-grade, red PVC
- Temperature range: -20°C to +75°C
- Sequential footage markings to facilitate installation
- Includes ripcord

Applications:

- Wiring of fire alarms
- Smoke alarms
- Voice communications
- Burglar alarms
- Fire protective circuits
- Suggested voltage rating: 300 volts

Compliances:

- NEC Article 760 Type FPLR (UL: 75°C, 300V)
- California State Fire Marshall Approved
- RoHS Compliant Directive 2002/95/EC
- Designed to meet UL 1666 Flame Test

Packaging:

- Please contact Customer Service for packaging and color options

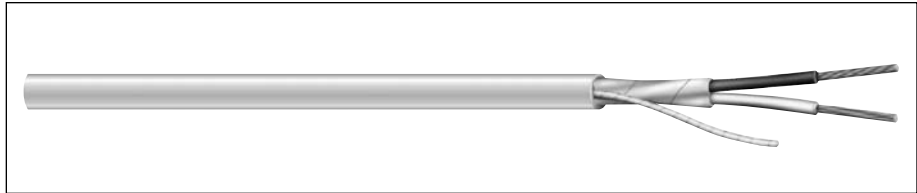

CATALOG NUMBER	NO. OF COND.	AWG SIZE	COND. STRAND	NOM. INSULATION THICKNESS		NOM. JACKET WALL		NOMINAL O.D.	
				INCHES	mm	INCHES	mm	INCHES	mm

22 AWG CONDUCTORS

E2482S	2	22	Solid	0.010	0.25	0.015	0.38	0.126	3.20
E2484S	4	22	Solid	0.010	0.25	0.015	0.38	0.145	3.68

18 AWG CONDUCTORS

E2502S	2	18	Solid	0.010	0.25	0.015	0.38	0.158	4.01
E2503S	3	18	Solid	0.010	0.25	0.015	0.38	0.165	4.19
E2504S	4	18	Solid	0.010	0.25	0.015	0.38	0.183	4.65
E2506S	6	18	Solid	0.010	0.25	0.015	0.38	0.216	5.49
E2508S	8	18	Solid	0.010	0.25	0.015	0.38	0.235	5.97

16 AWG CONDUCTORS

E2522S	2	16	Solid	0.010	0.25	0.015	0.38	0.180	4.57
E2524S	4	16	Solid	0.010	0.25	0.015	0.38	0.210	5.33

14 AWG CONDUCTORS

E2532S	2	14	Solid	0.013	0.33	0.015	0.38	0.218	5.54
E2534S	4	14	Solid	0.013	0.33	0.015	0.38	0.253	6.43

12 AWG CONDUCTORS

E2542S	2	12	Solid	0.013	0.33	0.015	0.38	0.252	6.40
E2544S	4	12	Solid	0.013	0.33	0.015	0.38	0.293	7.44

Color Code Chart

NO. OF COND.	COLOR
1	Black
2	Red
3	Brown
4	Blue
5	Orange
6	Yellow
7	Violet
8	Gray

Multi-Conductor, Shielded, Non-Plenum

CSA FAS 105, FPL (UL), NEC Type PLTC

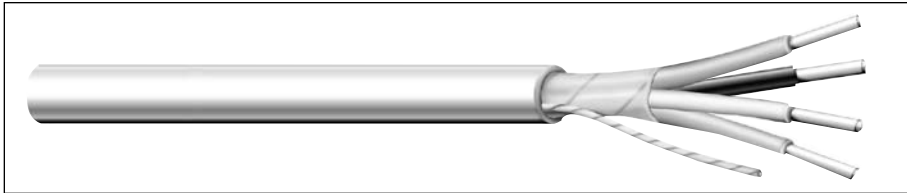

CATALOG NUMBER	NO. OF COND.	AWG SIZE	COND. STRAND	DRAIN WIRE AWG	NOM. INSULATION THICKNESS		NOM. JACKET THICKNESS		NOMINAL O.D.	
					INCHES	mm	INCHES	mm	INCHES	mm
C4334A	2	18	Solid	22	0.015	0.38	0.042	1.07	0.230	5.84
C4335A	3	18	Solid	22	0.015	0.38	0.042	1.07	0.241	6.12
C4336A	4	18	Solid	22	0.015	0.38	0.042	1.07	0.260	6.60
C4337A	5	18	Solid	22	0.015	0.38	0.042	1.07	0.279	7.09
C4338A	6	18	Solid	22	0.015	0.38	0.042	1.07	0.301	7.65
C4339A	7	18	Solid	22	0.015	0.38	0.042	1.07	0.301	7.65
C4340A	8	18	Solid	22	0.015	0.38	0.042	1.07	0.322	8.18
C4341A	9	18	Solid	22	0.015	0.38	0.042	1.07	0.344	8.74
C4342A	10	18	Solid	22	0.015	0.38	0.042	1.07	0.371	9.42
C4343A	30	18	Solid	22	0.015	0.38	0.053	1.35	0.563	14.30
C4344A	2	16	Solid	22	0.015	0.38	0.042	1.07	0.251	6.37
C4345A	3	16	Solid	22	0.015	0.38	0.042	1.07	0.263	6.68
C4346A	4	16	Solid	22	0.015	0.38	0.042	1.07	0.285	7.24
C4350A	5	16	Solid	22	0.015	0.38	0.042	1.07	0.307	7.80
C4347A	2	14	Solid	16	0.015	0.38	0.042	1.07	0.277	7.04
C4348A	2	12	Solid	16	0.020	0.51	0.042	1.07	0.331	8.41

Product Construction:

Conductor:

- 18-12 AWG fully annealed, solid bare copper per ASTM B-3

Insulation:

- Premium-grade, color-coded PVC
- Color code: See page 229 for the CSA Fire Alarm Color Code Chart

Shield:

- 100% Flexfoil® aluminum/polyester with 25% overlap, foil facing out
- Stranded tinned copper drain wire

Jacket:

- Premium-grade, red PVC; brown as an option
- Temperature range: -20°C to +105°C
- TRU-Mark® print legend contains footage markings from 1000' to 0'

Applications:

- Wiring of fire alarms
- Smoke alarms
- Voice communications
- Burglar alarms
- Fire protective circuits
- Suggested voltage rating: 300 volts

Compliances:

- NEC Article 725 PLTC (UL: 105°C, 300V)
- NEC Article 760 Type FPL (UL: 105°C, 300V)
- CSA FAS 105 (CSA: 105°C, 300V)
- C22.2 No. 208-03 (R2008)
- Designed to meet UL 70,000 BTU Vertical Tray Flame Test
- Passes CSA FT-4 Vertical Flame Test

Packaging:

- Please contact Customer Service for packaging and color options



Multi-Conductor, Unshielded, Plenum

NEC Type FPLP

Product Construction:

Conductor:

- 22 thru 12 AWG fully annealed solid bare copper per ASTM B-3

Insulation:

- Premium-grade, color-coded Flexguard® PVC
- Color code: See chart below

Jacket:

- Premium-grade, red Flexguard® PVC
- Temperature range: 0°C to +75°C
- Sequential footage markings to facilitate installation
- Includes ripcord

Applications:

- Wiring of fire alarms
- Smoke detectors
- Voice communications
- Burglar alarms
- Fire protective circuits
- Suggested voltage rating: 300 volts

Compliances:

- NEC Article 760 Type FPLP (UL: 75°C, 300V)
- California State Fire Marshall Approved
- Designed to meet NFPA 262 and CSA FT-6 Steiner Tunnel Fire Tests for Plenum Applications

Packaging:

- Please contact Customer Service for packaging and color options

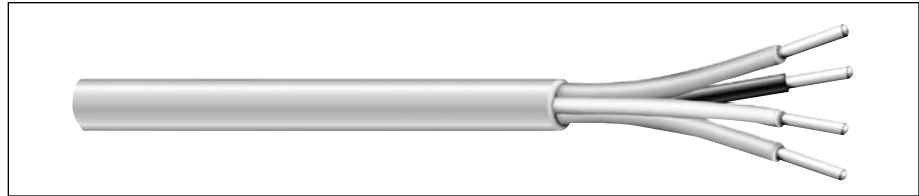

CATALOG NUMBER	NO. OF COND.	AWG SIZE	COND. STRAND	NOM. INSULATION THICKNESS		NOM. JACKET WALL		NOMINAL O.D.	
				INCHES	mm	INCHES	mm	INCHES	mm
22 AWG CONDUCTORS									
E3482S	2	22	Solid	0.010	0.25	0.015	0.38	0.121	3.07
E3484S	4	22	Solid	0.010	0.25	0.015	0.38	0.137	3.47
18 AWG CONDUCTORS									
E3502S	2	18	Solid	0.010	0.25	0.015	0.38	0.155	3.81
E3503S	3	18	Solid	0.010	0.25	0.015	0.38	0.160	4.06
E3504S	4	18	Solid	0.010	0.25	0.015	0.38	0.175	4.45
E3506S	6	18	Solid	0.010	0.25	0.015	0.38	0.211	5.36
16 AWG CONDUCTORS									
E3512S	2	16	Solid	0.010	0.25	0.015	0.38	0.172	4.37
E3514S	4	16	Solid	0.010	0.25	0.015	0.38	0.202	5.13
14 AWG CONDUCTORS									
E3522S	2	14	Solid	0.012	0.30	0.015	0.38	0.205	5.21
E3524S	4	14	Solid	0.012	0.30	0.015	0.38	0.243	6.17
12 AWG CONDUCTORS									
E3532S	2	12	Solid	0.012	0.30	0.015	0.38	0.244	6.20
E3534S	4	12	Solid	0.012	0.30	0.015	0.38	0.284	7.21

Color Code Chart

NO. OF COND.	COLOR
1	Black
2	Red
3	Brown
4	Blue
5	Orange
6	Yellow

Multi-Conductor, Unshielded, Plenum

NEC Type FPLP, PVDF Jacketed

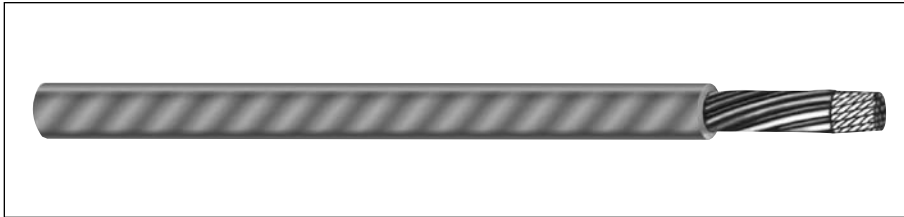

Product Construction

Conductor:

- 18 thru 12 AWG fully annealed solid bare copper to ASTM B-3

Insulation:

- Premium-grade, color-coded Flexguard® PVC
- Color code: See chart below

Jacket:

- Fluoropolymer, red
- Temperature range: -10°C to +75°C
- Includes ripcord

Applications:

- Fire alarm systems
- Voice communications
- Smoke detectors
- Pull boxes
- Suggested voltage rating: 300 volts

Compliances:

- NEC Article 760 Type FPLP (UL: 75°C, 300V)
- California State Fire Marshall Approved
- Designed to meet NFPA 262 and CSA FT-6 Steiner Tunnel Fire Tests for Plenum Applications

Features:

- Abrasion-, chemical- and water-resistant jacket
- Sequentially footage marked

Packaging:

- Please contact Customer Service for packaging and color options

CATALOG NUMBER	NO. OF COND	AWG SIZE	COND. STRAND	NOM. INSULATION THICKNESS		NOM. JACKET THICKNESS		NOMINAL O.D.		NOM.* C-C CAP. pF/ft
				IN	mm	IN	mm	IN	mm	
C3200	2	18	Solid	0.010	0.23	0.010	0.25	0.140	3.56	29.0
C3201	4	18	Solid	0.010	0.23	0.010	0.25	0.156	3.96	29.0
C3210	2	16	Solid	0.010	0.23	0.010	0.25	0.133	3.38	31.0
C3211	4	16	Solid	0.010	0.23	0.010	0.25	0.186	4.72	31.0
C3220	2	14	Solid	0.013	0.31	0.010	0.25	0.170	4.32	31.0
C3223	4	14	Solid	0.013	0.31	0.010	0.25	0.224	5.69	31.0
C3224	2	12	Solid	0.013	0.31	0.010	0.25	0.194	4.93	35.0
C3225	4	12	Solid	0.013	0.31	0.010	0.25	0.261	6.63	35.0

*Capacitance between conductors

Color Code Chart

NO. OF COND.	COLOR
1	Black
2	Red
3	Brown
4	Blue



Designed to Meet
NFPA 262 and CSA FT-6
Steiner Tunnel Fire Tests
for Plenum Applications

Underwriters Laboratories Inc.



Multi-Conductor, Shielded, Plenum

NEC Type FPLP

Product Construction:

Conductor:

- 22 thru 12 AWG fully annealed solid bare copper per ASTM B-3

Insulation:

- Premium-grade, color-coded Flexguard® PVC
- Color code: See chart below

Shield:

- Overall Flexfoil® polyester supported aluminum foil
- Stranded tinned copper drain wire

Jacket:

- Premium-grade, red Flexguard® PVC
- Suitable for use from 0°C to +75°C
- Sequential footage markings to facilitate installation
- Includes ripcord

Applications:

- Wiring of fire alarms
- Smoke detectors
- Voice communications
- Burglar alarms
- Fire protective circuits
- Suggested voltage rating: 300 volts

Compliances:

- NEC Article 760 Type FPLP (UL: 75°C, 300V)
- California State Fire Marshall Approved
- Designed to meet NFPA 262 and CSA FT-6 Steiner Tunnel Fire Tests for Plenum Applications

Packaging:

- Please contact Customer Service for packaging and color options

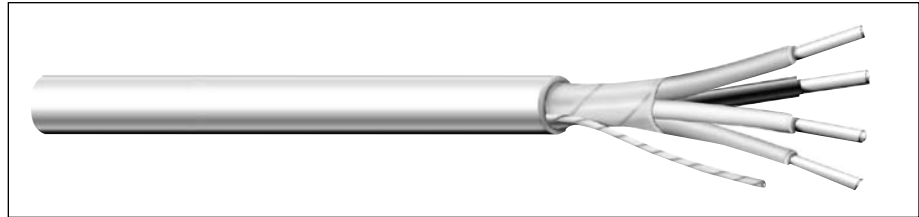

CATALOG NUMBER	NO. OF COND.	AWG SIZE	COND. STRAND	NOM. INSULATION THICKNESS		NOM. JACKET WALL		NOMINAL O.D.	
				INCHES	mm	INCHES	mm	INCHES	mm
22 AWG CONDUCTORS									
E3542S	2	22	Solid	0.010	0.25	0.015	0.38	0.126	3.20
18 AWG CONDUCTORS									
E3602S	2	18	Solid	0.010	0.25	0.015	0.38	0.158	4.01
E3603S	3	18	Solid	0.010	0.25	0.015	0.38	0.165	4.19
E3604S	4	18	Solid	0.010	0.25	0.015	0.38	0.183	4.65
E3606S	6	18	Solid	0.010	0.25	0.015	0.38	0.216	5.49
16 AWG CONDUCTORS									
E3612S	2	16	Solid	0.010	0.25	0.015	0.38	0.180	4.57
E3614S	4	16	Solid	0.010	0.25	0.015	0.38	0.210	5.33
14 AWG CONDUCTORS									
E3622S	2	14	Solid	0.012	0.30	0.015	0.38	0.210	5.33
E3624S	4	14	Solid	0.012	0.30	0.015	0.38	0.248	6.30
12 AWG CONDUCTORS									
E3632S	2	12	Solid	0.012	0.30	0.015	0.38	0.252	6.40
E3634S	4	12	Solid	0.012	0.30	0.015	0.38	0.300	7.62

Color Code Chart

NO. OF COND.	COLOR
1	Black
2	Red
3	Brown
4	Blue
5	Orange
6	Yellow

Multi-Conductor, Shielded, Plenum

NEC Type FPLP, PVDF Jacketed



CATALOG NUMBER	NO. OF COND.	AWG SIZE	COND. STRAND	NOM. INSULATION THICKNESS		NOM. JACKET THICKNESS		NOMINAL O.D.		NOMINAL CAP. * pF/ft	
				INCHES	mm	INCHES	mm	INCHES	mm	A	B
C3260	2	18	Solid	0.010	0.25	0.010	0.25	0.149	3.78	50.5	90.8
C3261	4	18	Solid	0.010	0.25	0.010	0.25	0.168	4.27	44.5	80.0
C3270	2	16	Solid	0.010	0.25	0.010	0.25	0.169	4.29	58.0	104.0
C3271	4	16	Solid	0.010	0.25	0.010	0.25	0.194	4.93	50.0	90.0
C3280	2	14	Solid	0.013	0.33	0.010	0.25	0.214	5.44	55.5	100.0
C3284	4	14	Solid	0.013	0.33	0.010	0.25	0.245	6.22	48.0	87.0
C3282	2	12	Solid	0.013	0.33	0.010	0.25	0.234	5.94	65.0	116.0
C3283	4	12	Solid	0.013	0.33	0.010	0.25	0.284	7.21	55.0	99.0

*A - Capacitance between conductors

*B - Capacitance between one conductor and other conductors connected to shield

Color Code Chart

NO. OF COND.	COLOR
1	Black
2	Red
3	Brown
4	Blue

Product Construction

Conductor:

- 18 thru 12 AWG fully annealed solid bare copper per ASTM B-3

Insulation:

- Premium-grade, color-coded Flexguard® PVC
- Color code: See chart below

Shield:

- 100% Flexfoil® aluminum/polyester foil, 25% overlap, minimum
- Stranded tinned copper drain wire

Jacket:

- Fluoropolymer, red
- Temperature range: -10°C to +75°C
- Includes ripcord

Applications:

- Fire alarm systems
- Voice communications
- Smoke detectors
- Pull boxes
- Suggested voltage rating: 300 volts

Compliances:

- NEC Article 760 Type FPLP (UL: 75°C, 300V)
- California State Fire Marshall Approved

Features:

- Abrasion-, chemical-resistant jacket
- Sequentially footage marked

Packaging:

- Please contact Customer Service for packaging and color options



Mid-Capacitance, Unshielded, Non-Plenum

NEC Type FPL for Microprocessor-Controlled Systems

Product Construction:

Conductor:

- 18 thru 12 AWG fully annealed solid bare copper per ASTM B-3

Insulation:

- Premium-grade, color-coded polypropylene
- Color code: See chart below

Jacket:

- PVC, red
- Temperature range: -20°C to +60°C

Applications:

- Addressable fire alarm systems
- Fire alarm systems
- Voice communications
- Smoke detectors
- Pull boxes
- Suggested voltage rating: 300 volts

Compliances:

- NEC Article 760 Type FPL (UL: 60°C, 300V)
- California State Fire Marshall Approved
- RoHS Compliant Directive 2002/95/EC
- Passes UL 70,000 BTU Vertical Tray Flame Test

Features:

- Red PVC jacket for easy critical circuit identification

Packaging:

- Please contact Customer Service for packaging and color options

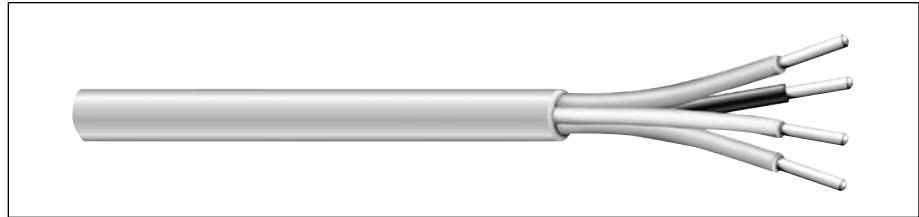

CATALOG NUMBER	NO. OF COND	AWG SIZE	COND. STRAND	NOM. INSULATION THICKNESS		NOM. JACKET THICKNESS		NOMINAL O.D.		NOM.* C-C CAP. pF/ft
				IN	mm	IN	mm	IN	mm	
C0471	2	18	Solid	0.014	0.36	0.020	0.51	0.177	4.50	16.5
C0485	4	18	Solid	0.014	0.36	0.020	0.51	0.205	5.21	16.5
C0473	2	16	Solid	0.016	0.41	0.020	0.51	0.206	5.23	17.5
C0486	4	16	Solid	0.016	0.41	0.020	0.51	0.240	6.10	17.5
C0491	2	14	Solid	0.018	0.46	0.020	0.51	0.240	6.10	18.0
C0492	2	12	Solid	0.020	0.51	0.020	0.51	0.282	7.16	19.0

*Capacitance between conductors

Color Code Chart

NO. OF COND.	COLOR
1	Black
2	Red
3	Brown
4	Blue

Mid-Capacitance, Shielded, Non-Plenum

NEC Type FPL for Microprocessor-Controlled Systems



CATALOG NUMBER	NO. OF COND.	AWG SIZE	COND. STRAND	NOM. INSULATION THICKNESS		NOM. JACKET THICKNESS		NOMINAL O.D.		NOMINAL CAP. * pF/ft	
				INCHES	mm	INCHES	mm	INCHES	mm	A	B
C0472	2	18	Solid	0.014	0.36	0.020	0.51	0.182	4.88	27.0	49.0
C0494	4	18	Solid	0.014	0.36	0.020	0.51	0.210	5.33	24.5	44.0
C0474	2	16	Solid	0.016	0.41	0.020	0.51	0.214	5.44	29.0	52.0
C0495	4	16	Solid	0.016	0.41	0.020	0.51	0.246	6.25	26.0	46.5
C0475	2	14	Solid	0.018	0.46	0.020	0.51	0.245	6.22	31.0	55.5
C0496	4	14	Solid	0.018	0.46	0.020	0.51	0.287	7.29	27.5	49.5
C0476	2	12	Solid	0.020	0.51	0.020	0.51	0.287	7.29	33.0	60.0
C0497	4	12	Solid	0.020	0.51	0.020	0.51	0.337	8.56	29.0	52.5

*A - Capacitance between conductors

*B - Capacitance between one conductor and other conductors connected to shield

Color Code Chart

NO. OF COND.	COLOR
1	Black
2	Red
3	Brown
4	Blue

Product Construction:

Conductor:

- 18 thru 12 AWG fully annealed solid bare copper per ASTM B-3

Insulation:

- Premium-grade, color-coded polypropylene
- Color code: See chart below

Shield:

- 100% Flexfoil® aluminum/polyester, 25% overlap, minimum
- Stranded tinned copper drain wire

Jacket:

- PVC, red
- Temperature range: 0°C to +60°C

Applications:

- Addressable fire alarm systems
- Fire alarm systems
- Voice communications
- Smoke detectors
- Pull boxes
- Suggested voltage rating: 300 volts

Compliances:

- NEC Article 760 Type FPL (UL: 60°C, 300V)
- California State Fire Marshall Approved
- RoHS Compliant Directive 2002/95/EC
- Passes UL 70,000 BTU Vertical Tray Flame Test

Features:

- Red PVC jacket for easy critical circuit identification

Packaging:

- Please contact Customer Service for packaging and color options

Mid-Capacitance, Unshielded, Plenum

NEC Type FPLP for Microprocessor-Controlled Systems

Product Construction:

Conductor:

- 18 thru 12 AWG fully annealed solid bare copper per ASTM B-3

Insulation:

- Premium-grade, color-coded fluoropolymer
- Color code: See chart below

Jacket:

- Premium-grade, red Flexguard® PVC
- Temperature range: 0°C to +75°C
- Includes ripcord

Applications:

- Addressable fire alarm systems
- Fire alarm systems
- Voice communications
- Smoke detectors
- Pull boxes
- Suggested voltage rating: 300 volts

Compliances:

- NEC Article 760 Type FPLP (UL: 75°C, 300V)
- California State Fire Marshall Approved
- Designed to meet NFPA 262 and CSA FT-6 Steiner Tunnel Fire Tests for Plenum Applications

Features:

- Red PVC jacket for easy critical circuit identification

Packaging:

- Please contact Customer Service for packaging and color options



CATALOG NUMBER	NO. OF COND	AWG SIZE	COND. STRAND	NOM. INSULATION THICKNESS		NOM. JACKET THICKNESS		NOMINAL O.D.		NOM.* C-C CAP. pF/ft
				IN	mm	IN	mm	IN	mm	
C3240	2	18	Solid	0.014	0.36	0.015	0.38	0.172	4.37	19.0
C3242	4	18	Solid	0.014	0.36	0.015	0.38	0.195	4.95	19.0
C3241	2	16	Solid	0.016	0.41	0.015	0.38	0.196	4.98	20.0
C3243	4	16	Solid	0.016	0.41	0.015	0.38	0.231	5.87	20.0
C3244	2	14	Solid	0.018	0.46	0.020	0.51	0.242	6.15	20.0
C3245	4	14	Solid	0.018	0.46	0.020	0.51	0.286	7.26	20.0
C3246	2	12	Solid	0.020	0.51	0.020	0.51	0.282	7.16	22.0
C3247	4	12	Solid	0.020	0.51	0.020	0.51	0.333	8.45	22.0

*Capacitance between conductors

Color Code Chart

NO. OF COND.	COLOR
1	Black
2	Red
3	Brown
4	Blue

Mid-Capacitance, Shielded, Plenum

NEC Type FPLP for Microprocessor-Controlled Systems



CATALOG NUMBER	NO. OF COND.	AWG SIZE	COND. STRAND	NOM. INSULATION THICKNESS		NOM. JACKET THICKNESS		NOMINAL O.D.		NOMINAL CAP. * pF/ft	
				INCHES	mm	INCHES	mm	INCHES	mm	A	B
C3167	2	18	Solid	0.014	0.36	0.015	0.38	0.172	4.37	31.0	56.0
C3170	4	18	Solid	0.014	0.36	0.015	0.38	0.202	5.13	28.0	50.0
C3168	2	16	Solid	0.016	0.41	0.015	0.38	0.203	5.16	33.0	59.0
C3171	4	16	Solid	0.016	0.41	0.015	0.38	0.238	6.05	29.0	53.0
C3172	2	14	Solid	0.018	0.46	0.020	0.51	0.247	6.27	35.0	63.0
C3173	4	14	Solid	0.018	0.46	0.020	0.51	0.289	7.34	30.0	56.0
C3174	2	12	Solid	0.020	0.51	0.020	0.51	0.289	7.34	38.0	68.0
C3175	4	12	Solid	0.020	0.51	0.020	0.51	0.340	8.64	33.0	60.0

*A - Capacitance between conductors

*B - Capacitance between one conductor and other conductors connected to shield

Color Code Chart

NO. OF COND.	COLOR
1	Black
2	Red
3	Brown
4	Blue

Product Construction

Conductor:

- 18 thru 12 AWG fully annealed solid bare copper per ASTM B-3

Insulation:

- Premium-grade, color-coded fluoropolymer
- Color code: See chart below

Shield:

- 100% Flexfoil® aluminum/polyester foil, 25% overlap, minimum
- Stranded tinned copper drain wire

Jacket:

- Premium-grade, red Flexguard® PVC
- Temperature range: 0°C to +75°C
- Includes ripcord

Applications:

- Addressable fire alarm systems
- Fire alarm systems
- Voice communications
- Smoke detectors
- Pull boxes
- Suggested voltage rating: 300 volts

Compliances:

- NEC Article 760 Type FPLP (UL: 75°C, 300V)
- California State Fire Marshall Approved
- Designed to meet NFPA 262 and CSA FT-6 Steiner Tunnel Fire Tests for Plenum Applications

Features:

- Red PVC jacket for easy critical circuit identification

Packaging:

- Please contact Customer Service for packaging and color options

Designed to Meet NFPA 262 and CSA FT-6 Steiner Tunnel Fire Tests for Plenum Applications

Underwriters Laboratories Inc.

Multi-Paired, Unshielded, Non-Plenum

CSA FAS 105, FPL (UL), NEC Type PLTC

Product Construction

Conductor:

- 22 and 18 AWG fully annealed solid bare copper per ASTM B-3

Insulation:

- Premium-grade, color-coded PVC
- Color code: See page 229 for the CSA Fire Alarm Color Code Chart

Jacket:

- Premium-grade, red PVC; brown as an option
- Temperature range: -20°C to +105°C
- TRU-Mark® print legend contains footage markings from 1000' to 0'



CATALOG NUMBER	NO. OF PAIRS	AWG SIZE	COND. STRAND	NOM. INSULATION THICKNESS		NOM. JACKET THICKNESS		NOMINAL O.D.	
				INCHES	mm	INCHES	mm	INCHES	mm

C4328A	3	22	Solid	0.012	0.30	0.042	1.07	0.279	7.09
C4329A	6	22	Solid	0.012	0.30	0.042	1.07	0.350	8.89
C4330A	12	22	Solid	0.012	0.30	0.053	1.35	0.474	12.04
C4331A	15	22	Solid	0.012	0.30	0.053	1.35	0.523	13.28
C4332A	27	22	Solid	0.012	0.30	0.063	1.60	0.672	17.07
C4333A	6	18	Solid	0.015	0.38	0.053	1.35	0.487	12.37

Applications:

- Wiring of fire alarms
- Smoke alarms
- Voice communications
- Burglar alarms
- Fire protection circuits
- Suggested voltage rating: 300 volts

Compliances:

- NEC Article 725 PLTC (UL: 105°C, 300V)
- NEC Article 760 Type FPL (UL: 105°C, 300V)
- CSA FAS 105 (CSA: 105°C, 300V)
- C22.2 No. 208-03 (R2008)
- Designed to meet UL 70,000 BTU Vertical Tray Flame Test
- Passes CSA FT-4 Vertical Flame Test

Packaging:

- Please contact Customer Service for packaging and color options

Sound, Alarm & Security Cable

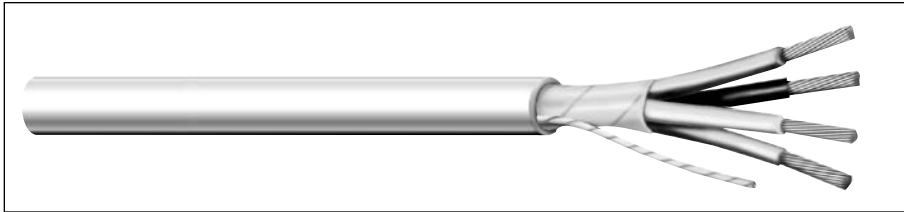

The sound and security industry in the United States has grown from a simple and unsophisticated business, begun some 45 years ago, to one which has developed technology to the degree that specialized wires and cables are now much in demand.

No longer are the security and sound industries characterized by large electromechanical relays and large contactors; today these circuits incorporate the latest in microprocessors and solid state devices to not only improve functionality but also to guarantee performance.

As a major wire producer, our role is to ensure that the wires and cables that go into these systems are as reliable as the other components ... the net result is a fully integrated system which will provide peace of mind to the system user.

Also in this section are General Cable's Carol® Brand wire and cable designs suitable for a variety of applications, both in industrial and commercial

environments, including telephone systems, intercoms, burglar alarms, business machines and thermostats.

Aside from the quality materials used in these designs, specifiers and users of Carol® Brand wire and cable products have come to expect that these cables are registered and certified with the leading regulatory agencies such as Underwriters Laboratories ... and we haven't let you down!

Carol® Brand designs have proven themselves in the area of sound and security over time; most are fabricated with solid or stranded, bare copper conductors with insulations and jackets of premium grades of PVC. We offer both parallel and cabled designs both with and without shields. Sequential footage markings on the jackets are offered on all products.

General Cable Carol® Brand products are conveniently packaged in 1000' or 500' lengths to assist the installer.

Index	Page
Composite Access Control Cable	131
Composite Access Control Cable, Plenum	132
Composite Access Control Cable, Riser	133
Multi-Conductor, Unshielded, Riser	134
Multi-Conductor, Shielded, Riser	135
Multi-Conductor, Unshielded, Plenum	136
Multi-Conductor, Shielded, Plenum	137
Telephone Station/Intercom & Speaker/Burglar Alarm	138
Antenna Rotor	139
Low-Voltage Sprinkler Wire	140
Thermostat Wire Type LVT	141
Thermostat Wire Type CL2	142
Thermostat Wire, Unjacketed	143
Carol® Helix/Hi-Temp® Category 6 Cable	144
Carol® Helix/Hi-Temp® Category 5e Cable	145

**CAROL
BRAND****ELECTRONICS
WIRE & CABLE**

■ Carol® Brand Composite Access Control Cable

General Cable's **Carol® Brand Composite Access Control Cable** is manufactured for use in Building Access & Control. The cable is designed to allow for a single cable run that incorporates the four components required for card readers, door contacts, locking power and retinal scanners in commercial buildings, distribution centers, manufacturing facilities and government buildings.

The cables are installer friendly, as they save time and money on installation. With multiple cables under one jacket, time is saved in preparation and setup, pulling and termination. The convenience of these cables at installation makes them a popular choice for multiple Access Control applications.

When your job requires Access Control cable, think of Carol® Brand cables first. Remember, you can always **Demand Better...Expect More™** with General Cable Carol® Brand Electronic Cables. We manufacture over 1,300 standard electronic cables that we can ship direct from stock, and we have the technical staff and design expertise to meet any custom cable requirement.



Special Application Cable

Hook-Up Wire

Plenum Cable

Coaxial Cable

Microphone Cable

Computer Cable

General Purpose Cable

Multi-Conductor Communication
& Control Cable

Multi-Paired Communication
& Control Cable

Fire Alarm Cable

Sound & Security Cable

For more information, contact your local General Cable representative.

 **General Cable**

**CAROL
BRAND**

Composite Access Control Cable, Plenum

NEC Type CMP, UL, c(UL)

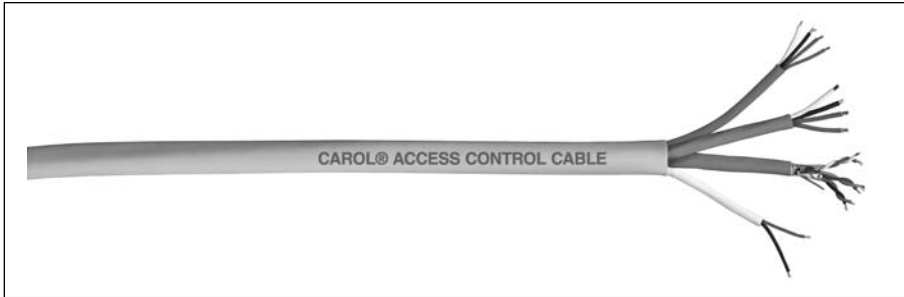

Product Construction:

Conductor:

- Stranded bare copper

Jacket:

- Flexguard® PVC
- Temperature range: 0°C to +60°C
- Individual elements marked for application (see diagram below)
- Yellow overall jacket

Shields:

- Choice between all 4 elements shielded or just the 3-pair element shielded

Applications:

- Security systems
- Access control
- Card reader
- Door control
- REX
- Power-limited controls

Compliances:

- NEC Article 800 Type CMP (UL), c(UL)
- RoHS Compliant Directive 2002/95/EC

Packaging:

- 500' and 1000' reels

CATALOG NUMBER	OVERALL NOMINAL O.D. INCH (MM)	COMPONENT NO.	COMPONENT DESCRIPTIONS	CONDUCTORS COLOR CODE	COMPONENT NOMINAL O.D. INCH (MM)	INSULATION THICKNESS INCH (MM)
4EPL4S	0.430	1	4 Cond, 18 AWG, Shielded	White, Black, Red, Green	0.180 (4.572)	0.008 (0.2032)
		2	3 Pair, 22 AWG, Shielded	White & Green, Orange & Brown, Red & Black	0.195 (4.593)	0.008 (0.2032)
		3	2 Cond, 22 AWG, Shielded	Red, Black	0.125 (3.175)	0.008 (0.2032)
		4	4 Cond, 22 AWG, Shielded	White, Black, Red, Green	0.145 (3.683)	0.008 (0.2032)
4EPL1S	0.420	1	4 Cond, 18 AWG, Unshielded	White, Black, Red, Green	0.180 (4.572)	0.008 (0.2032)
		2	3 Pair, 22 AWG, Shielded	White & Green, Orange & Brown, Red & Black	0.195 (4.593)	0.008 (0.2032)
		3	2 Cond, 22 AWG, Unshielded	Red, Black	0.125 (3.175)	0.008 (0.2032)
		4	4 Cond, 22 AWG, Unshielded	White, Black, Red, Green	0.145 (3.683)	0.008 (0.2032)

Jacket Color Coding & Component Application

Jacket Color	Component	Cable Type	Application
Gray	1	4 Conductor, 18 AWG	Lock Power
Orange	2	3 Pair, 22 AWG	Card Reader
White	3	2 Conductor, 22 AWG	Door Contact
Blue	4	4 Conductor, 22 AWG	Rex/Spare

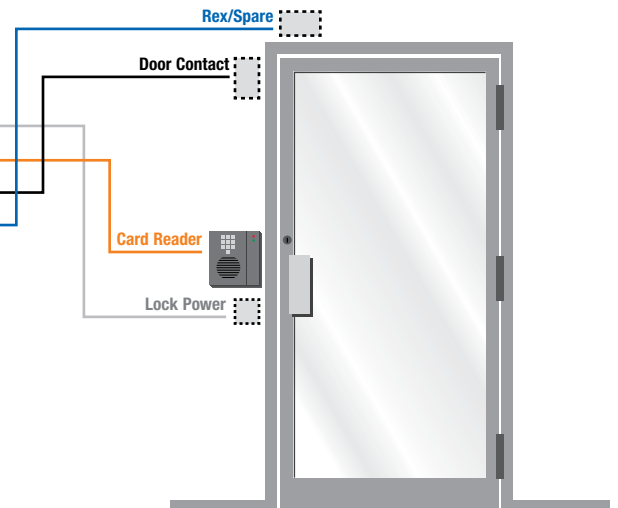

Composite Access Control Cable, Riser

NEC Type CMR, UL, c(UL)

Product Construction:

Conductor:

- Stranded bare copper

Jacket:

- PVC
- Temperature range: -20°C to +60°C
- Individual elements marked for application (see diagram below)
- Blue overall jacket

Shields:

- Choice between all 4 elements shielded or just the 3-pair shielded

Applications:

- Security systems
- Access control
- Card reader
- Door control
- REX
- Power-limited controls

Compliances:

- NEC Article 800 Type CMR (UL), c(UL)
- RoHS Compliant Directive 2002/95/EC

Packaging:

- 500' and 1000' reels

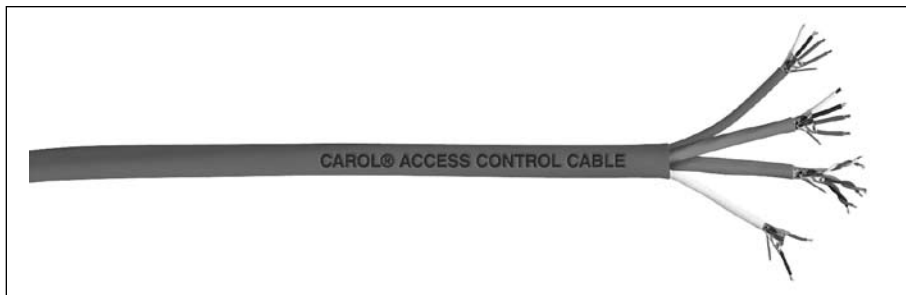

CATALOG NUMBER	OVERALL NOMINAL O.D. INCH (MM)	COMPONENT NO.	COMPONENT DESCRIPTIONS	CONDUCTORS COLOR CODE	COMPONENT NOMINAL O.D. INCH (MM)	INSULATION THICKNESS INCH (MM)
4ERS4S	0.430	1	4 Cond, 18 AWG, Shielded	White, Black, Red, Green	0.180 (4.572)	0.008 (0.2032)
		2	3 Pair, 22 AWG, Shielded	White & Green, Orange & Brown, Red & Black	0.195 (4.993)	0.008 (0.2032)
		3	2 Cond, 22 AWG, Shielded	Red, Black	0.125 (3.175)	0.008 (0.2032)
		4	4 Cond, 22 AWG, Shielded	White, Black, Red, Green	0.145 (3.683)	0.008 (0.2032)
4ERS1S	0.420	1	4 Cond, 18 AWG, Unshielded	White, Black, Red, Green	0.180 (4.572)	0.008 (0.2032)
		2	3 Pair, 22 AWG, Shielded	White & Green, Orange & Brown, Red & Black	0.195 (4.993)	0.008 (0.2032)
		3	2 Cond, 22 AWG, Unshielded	Red, Black	0.125 (3.175)	0.008 (0.2032)
		4	4 Cond, 22 AWG, Unshielded	White, Black, Red, Green	0.145 (3.683)	0.008 (0.2032)

Jacket Color Coding & Component Application

Jacket Color	Component	Cable Type	Application
Gray	1	4 Conductor, 18 AWG	Lock Power
Orange	2	3 Pair, 22 AWG	Card Reader
White	3	2 Conductor, 22 AWG	Door Contact
Blue	4	4 Conductor, 22 AWG	Rex/Spare

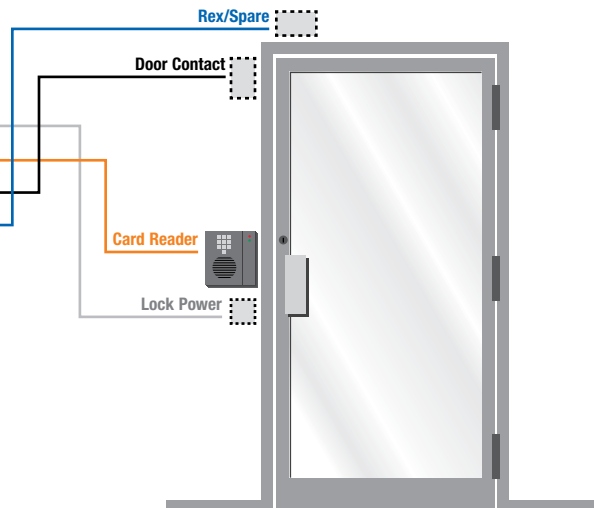

Multi-Conductor, Unshielded, Riser

NEC Type CMR and/or CL3R

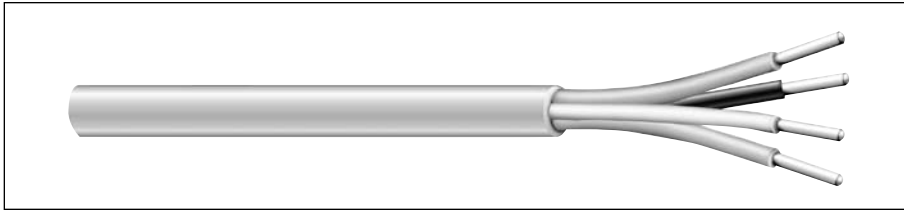

Product Construction:

Conductor:

- Stranded or solid bare copper per ASTM B-3, B-8 and B-286

Insulation:

- Premium-grade, color-coded S-R PVC
- Color code: See chart below

Jacket:

- Premium-grade, gray PVC
- Sequential footage markings to facilitate installation
- Temperature range: -20°C to +75°C
- Includes ripcord

Applications:

- Power-limited control circuits
- Wiring of the following systems:
 - Intercom
 - Security
 - Audio
 - Background music
- Suggested voltage rating: 300 volts

Compliances:

- NEC Article 725 Type CL3R (UL: 75°C, 150V)
- NEC Article 800 Type CMR (UL: 75°C, 300V)
- RoHS Compliant Directive 2002/95/EC
- California State Fire Marshall Approved

Packaging:

- Please contact Customer Service for packaging and color options

Color Code Chart

NO. OF COND.	COLOR	NO. OF COND.	COLOR
1	Black	7	Orange
2	Red	8	Yellow
3	White	9	Violet
4	Green	10	Gray
5	Brown	11	Pink
6	Blue	12	Tan

CATALOG NUMBER	NO. OF COND.	AWG SIZE	COND. STRAND	NOM. INSULATION THICKNESS		NOM. JACKET WALL		NOMINAL O.D.	
				INCHES	mm	INCHES	mm	INCHES	mm
22 AWG CONDUCTORS									
E1000S	2	22	Solid	0.007	0.20	0.015	0.38	0.118	3.00
E1001S	4	22	Solid	0.007	0.20	0.015	0.38	0.126	3.20
E1002S	2	22	7/30	0.008	0.20	0.015	0.38	0.122	3.10
E1003S	3	22	7/30	0.008	0.20	0.015	0.38	0.141	3.58
E1004S	4	22	7/30	0.008	0.20	0.015	0.38	0.141	3.66
E1006S	6	22	7/30	0.008	0.20	0.015	0.38	0.164	4.17
E1008S	8	22	7/30	0.008	0.20	0.015	0.38	0.180	4.57
E1010S	10	22	7/30	0.008	0.20	0.015	0.38	0.212	5.38
E1012S	12	22	7/30	0.008	0.20	0.015	0.38	0.219	5.56
20 AWG CONDUCTORS									
E1022S	2	20	7/28	0.007	0.18	0.015	0.38	0.134	3.40
E1023S	3	20	7/28	0.008	0.20	0.015	0.38	0.134	3.40
E1024S	4	20	7/28	0.008	0.20	0.015	0.38	0.142	3.60
18 AWG CONDUCTORS									
E1030S	2	18	Solid	0.008	0.20	0.015	0.38	0.144	3.66
E1032S	2	18	7/26	0.009	0.23	0.015	0.38	0.156	3.96
E1033S	3	18	7/26	0.009	0.23	0.015	0.38	0.166	4.22
E1034S	4	18	7/26	0.009	0.23	0.015	0.38	0.187	4.75
E1036S	6	18	7/26	0.008	0.20	0.015	0.38	0.225	5.72
E1038S	8	18	7/26	0.008	0.20	0.015	0.38	0.245	6.22
E1040S	10	18	7/26	0.008	0.20	0.015	0.38	0.282	7.16
E1041S	12	18	7/26	0.009	0.23	0.015	0.38	0.291	7.39
16 AWG CONDUCTORS									
E1042S	2	16	19/.0117	0.009	0.25	0.015	0.38	0.178	4.52
E1043S	3	16	19/.0117	0.009	0.25	0.015	0.38	0.193	4.90
E1044S	4	16	19/.0117	0.009	0.25	0.015	0.38	0.210	5.33
14 AWG CONDUCTORS									
E1052S*	2	14	19/.0147	0.013	0.33	0.015	0.38	0.224	5.69
E1054S*	4	14	19/.0147	0.013	0.33	0.015	0.38	0.264	6.71
12 AWG CONDUCTORS									
E1062S*	2	12	19/.0185	0.013	0.33	0.015	0.38	0.260	6.60
E1064S*	4	12	19/.0185	0.013	0.33	0.015	0.38	0.312	7.92

* NEC CL3R only

Multi-Conductor, Shielded, Riser

NEC Type CMR and/or CL3R

Product Construction:

Conductor:

- Stranded or solid bare copper per ASTM B-3, B-8 and B-286

Insulation:

- Premium-grade, color-coded S-R PVC
- Color code: See chart below

Shield:

- Overall Flexfoil® polyester supported aluminum foil
- Stranded tinned copper drain wire

Jacket:

- Premium-grade, gray PVC
- Sequential footage markings to facilitate installation
- Temperature range: -20°C to +75°C
- Includes ripcord

Applications:

- Power-limited control circuits
- Wiring of the following systems:
 - Intercom
 - Security
 - Audio
 - Background music
- Suggested voltage rating: 300 volts

Compliances:

- NEC Article 725 Type CL3R (UL: 75°C, 150V)
- NEC Article 800 Type CMR (UL: 75°C, 300V)
- RoHS Compliant Directive 2002/95/EC
- California State Fire Marshall Approved

Packaging:

- Please contact Customer Service for packaging and color options

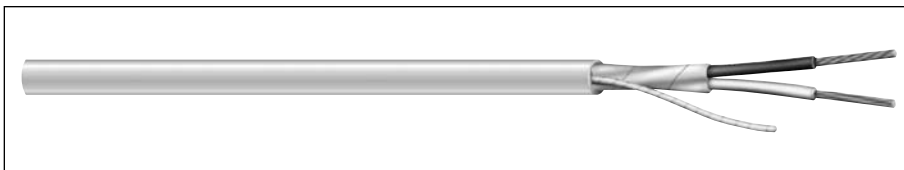

CATALOG NUMBER	NO. OF COND.	AWG SIZE	COND. STRAND	NOM. INSULATION THICKNESS		NOM. JACKET WALL		NOMINAL O.D.	
				INCHES	mm	INCHES	mm	INCHES	mm

22 AWG CONDUCTORS

E2000S	2	22	Solid	0.008	0.20	0.015	0.38	0.117	2.97
E2002S	2	22	7/30	0.008	0.20	0.015	0.38	0.132	3.35
E2003S	3	22	7/30	0.008	0.20	0.015	0.38	0.135	3.43
E2004S	4	22	7/30	0.008	0.20	0.015	0.38	0.147	3.73
E2006S	6	22	7/30	0.008	0.20	0.015	0.38	0.173	4.39
E2008S	8	22	7/30	0.008	0.20	0.015	0.38	0.195	4.95
E2010S	10	22	7/30	0.008	0.20	0.015	0.38	0.218	5.54
E2012S	12	22	7/30	0.010	0.25	0.015	0.38	0.238	6.05

20 AWG CONDUCTORS

E2022S	2	20	7/28	0.007	0.18	0.015	0.38	0.142	3.61
E2023S	3	20	7/28	0.008	0.20	0.015	0.38	0.151	3.84
E2024S	4	20	7/28	0.007	0.18	0.015	0.38	0.171	4.34

18 AWG CONDUCTORS

E2030S	2	18	Solid	0.009	0.20	0.015	0.38	0.147	3.73
E2032S	2	18	7/26	0.009	0.23	0.015	0.38	0.164	4.17
E2033S	3	18	7/26	0.009	0.23	0.015	0.38	0.172	4.37
E2034S	4	18	7/26	0.009	0.23	0.015	0.38	0.187	4.75
E2036S	6	18	7/26	0.008	0.20	0.015	0.38	0.230	5.54
E2038S	8	18	7/26	0.008	0.20	0.015	0.38	0.250	6.35
E2040S	10	18	7/26	0.008	0.20	0.015	0.38	0.287	7.29
E2041S	12	18	7/26	0.008	0.20	0.015	0.38	0.296	7.52

16 AWG CONDUCTORS

E2042S	2	16	19/.0117	0.009	0.23	0.015	0.38	0.189	4.80
E2043S	3	16	19/.0117	0.009	0.23	0.015	0.38	0.198	5.03
E2044S	4	16	19/.0117	0.009	0.23	0.015	0.38	0.219	5.56

14 AWG CONDUCTORS

E2052S*	2	14	19/.0147	0.013	0.33	0.015	0.38	0.245	6.22
E2054S*	4	14	19/.0147	0.013	0.33	0.015	0.38	0.269	6.83

12 AWG CONDUCTORS

E2062S*	2	12	19/.0185	0.013	0.33	0.015	0.38	0.281	7.14
E2064S*	4	12	19/.0185	0.013	0.33	0.015	0.38	0.312	7.92

* NEC CL3R only

Color Code Chart

NO. OF COND.	COLOR	NO. OF COND.	COLOR
1	Black	7	Orange
2	Red	8	Yellow
3	White	9	Violet
4	Green	10	Gray
5	Brown	11	Pink
6	Blue	12	Tan

Multi-Conductor, Unshielded, Plenum

NEC Type CMP and/or CL3P

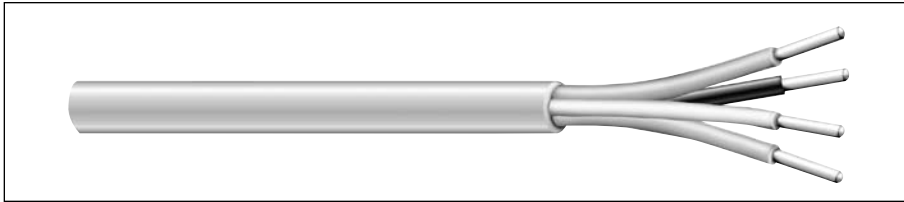

Product Construction:

Conductor:

- Stranded or solid bare copper per ASTM B-3, B-8 and B-286

Insulation:

- Premium-grade, color-coded Flexguard® PVC
- Color code: See chart below

Jacket:

- Premium-grade natural Flexguard® PVC
- Sequential footage markings to facilitate installation
- Temperature range: 0°C to +75°C
- Ripcord available—consult Customer Service for details

Applications:

- Power-limited control circuits
- Wiring of the following systems:
Intercom
Security
Audio
Background music
- Suggested voltage rating: 300 volts

Compliances:

- NEC Article 725 Type CL3P (UL: 75°C, 150V)
- NEC Article 800 Type CMP (UL: 75°C, 300V)
- Designed to meet NFPA 262 Flame Test
- California State Fire Marshall Approved

Packaging:

- Please contact Customer Service for packaging and color options

Color Code Chart

NO. OF COND.	COLOR	NO. OF COND.	COLOR
1	Black	7	Orange
2	Red	8	Yellow
3	White	9	Violet
4	Green	10	Gray
5	Brown	11	Pink
6	Blue	12	Tan

CATALOG NUMBER	NO. OF COND.	AWG SIZE	COND. STRAND	NOM. INSULATION THICKNESS		NOM. JACKET WALL		NOMINAL O.D.	
				INCHES	mm	INCHES	mm	INCHES	mm
22 AWG CONDUCTORS									
E3000S	2	22	Solid	0.007	0.18	0.015	0.38	0.108	2.74
E3001S	4	22	Solid	0.007	0.18	0.015	0.38	0.124	3.15
E3002S	2	22	7/30	0.008	0.20	0.015	0.38	0.120	3.05
E3003S	3	22	7/30	0.008	0.20	0.015	0.38	0.127	3.23
E3004S	4	22	7/30	0.008	0.20	0.015	0.38	0.139	3.53
E3006S	6	22	7/30	0.008	0.20	0.015	0.38	0.164	4.17
E3008S	8	22	7/30	0.008	0.20	0.015	0.38	0.178	4.52
E3010S	10	22	7/30	0.008	0.20	0.015	0.38	0.194	4.92
E3012S	12	22	7/30	0.008	0.20	0.015	0.38	0.211	5.36
20 AWG CONDUCTORS									
E3022S	2	20	7/28	0.009	0.23	0.015	0.38	0.138	3.51
E3023S	3	20	7/28	0.009	0.23	0.015	0.38	0.146	3.71
E3024S	4	20	7/28	0.009	0.23	0.015	0.38	0.161	4.09
18 AWG CONDUCTORS									
E3030S	2	18	Solid	0.008	0.20	0.015	0.38	0.142	3.61
E3032S	2	18	7/26	0.008	0.20	0.015	0.38	0.156	3.96
E3033S	3	18	7/26	0.008	0.20	0.015	0.38	0.166	4.22
E3034S	4	18	7/26	0.008	0.20	0.015	0.38	0.187	4.75
E3036S	6	18	7/26	0.008	0.20	0.015	0.38	0.216	5.49
E3038S	8	18	7/26	0.008	0.20	0.015	0.38	0.235	5.97
16 AWG CONDUCTORS									
E3042S	2	16	19/.0117	0.008	0.20	0.015	0.38	0.174	4.42
E3043S	3	16	19/.0117	0.008	0.20	0.015	0.38	0.185	4.70
E3044S	4	16	19/.0117	0.009	0.23	0.015	0.38	0.205	5.21
14 AWG CONDUCTORS									
E3052S*	2	14	19/.0147	0.011	0.28	0.015	0.38	0.216	5.49
E3054S*	4	14	19/.0147	0.011	0.28	0.015	0.38	0.255	6.48
12 AWG CONDUCTORS									
E3062S*	2	12	19/.0185	0.011	0.28	0.015	0.38	0.252	6.40
E3064S*	4	12	19/.0185	0.011	0.28	0.015	0.38	0.298	7.57

* NEC CL3P only



Multi-Conductor, Shielded, Plenum

NEC Type CMP and/or CL3P

Product Construction:

Conductor:

- Stranded or solid bare copper per ASTM B-3, B-8 and B-286

Insulation:

- Premium-grade, color-coded Flexguard® PVC

Shield:

- Overall Flexfoil® polyester supported aluminum foil
- Stranded tinned copper drain wire

Jacket:

- Premium-grade natural Flexguard® PVC
- Sequential footage markings to facilitate installation
- Temperature range: 0°C to +75°C
- Ripcord available—consult Customer Service for details

Applications:

- Power-limited control circuits
- Wiring of the following systems:
 - Intercom
 - Security
 - Audio
 - Background music
- Suggested voltage rating: 300 volts

Compliances:

- NEC Article 725 Type CL3P (UL: 75°C, 150V)
- NEC Article 800 Type CMP (UL: 75°C, 300V)
- Designed to meet NFPA 262 Flame Test
- California State Fire Marshall Approved

Packaging:

- Please contact Customer Service for packaging and color options

Color Code Chart

NO. OF COND.	COLOR
1	Black
2	Red
3	White
4	Green
5	Brown
6	Blue
7	Orange
8	Yellow



CATALOG NUMBER	NO. OF COND.	AWG SIZE	COND. STRAND	NOM. INSULATION THICKNESS		NOM. JACKET WALL		NOMINAL O.D.	
				INCHES	mm	INCHES	mm	INCHES	mm

22 AWG CONDUCTORS

E2100S	2	22	Solid	0.007	0.18	0.015	0.38	0.116	2.95
E2102S	2	22	7/30	0.008	0.20	0.015	0.38	0.128	3.25
E2103S	3	22	7/30	0.008	0.20	0.015	0.38	0.131	3.33
E2104S	4	22	7/30	0.008	0.20	0.015	0.38	0.147	3.73
E2106S	6	22	7/30	0.008	0.20	0.015	0.38	0.176	4.47
E2108S	8	22	7/30	0.010	0.25	0.015	0.38	0.184	4.67

20 AWG CONDUCTORS

E2122S	2	20	7/28	0.009	0.23	0.015	0.38	0.143	3.63
E2123S	3	20	7/28	0.009	0.23	0.015	0.38	0.151	3.84
E2124S	4	20	7/28	0.009	0.23	0.015	0.38	0.166	4.22

18 AWG CONDUCTORS

E2200S	2	18	Solid	0.008	0.20	0.015	0.38	0.148	3.76
E2202S	2	18	7/26	0.008	0.20	0.015	0.38	0.164	4.17
E2203S	3	18	7/26	0.008	0.20	0.015	0.38	0.169	4.29
E2204S	4	18	7/26	0.008	0.20	0.015	0.38	0.185	4.70
E2206S	6	18	7/26	0.010	0.25	0.015	0.38	0.230	5.84
E2208S	8	18	7/26	0.010	0.25	0.015	0.38	0.252	6.40

16 AWG CONDUCTORS

E2242S	2	16	19/.0117	0.008	0.20	0.015	0.38	0.179	4.55
E2243S	3	16	19/.0117	0.008	0.20	0.015	0.38	0.190	4.83
E2244S	4	16	19/.0117	0.008	0.20	0.015	0.38	0.209	5.31

14 AWG CONDUCTORS

E2252S*	2	14	19/.0147	0.008	0.20	0.015	0.38	0.207	5.26
E2254S*	4	14	19/.0147	0.008	0.20	0.015	0.38	0.260	6.60

12 AWG CONDUCTORS

E2262S*	2	12	19/.0185	0.008	0.20	0.015	0.38	0.244	6.20
E2264S*	4	12	19/.0185	0.008	0.20	0.015	0.38	0.288	7.32

* NEC CL3P only

Telephone Station/Intercom & Speaker/ Burglar Alarm

NEC Types CMR or CM/CL2 and CMX-Outdoor

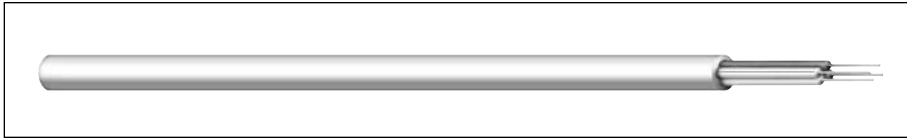

CATALOG NUMBER	NO. OF COND.	AWG SIZE	COND. STRAND	NOM. INSULATION THICKNESS		NOM. JACKET THICKNESS		NOMINAL O.D.	
				INCHES	mm	INCHES	mm	INCHES	mm

INTERCOM, SPEAKER AND BURGLAR ALARM

C4408*	2	22	Solid	0.007	0.18	0.020	0.51	0.115	2.92
C4408ST*	2	22	7/.0096	0.007	0.18	0.020	0.51	0.125	3.18
C4410	3	22	Solid	0.007	0.18	0.016	0.41	0.118	3.00
C4412*	4	22	Solid	0.007	0.18	0.015	0.38	0.125	3.18
C4412ST*	4	22	7/.0096	0.007	0.18	0.015	0.38	0.135	3.43

Color Code Chart

NO. OF PAIRS	COLOR	NO. OF PAIRS	COLOR
1	Red	3	Yellow
2	Green	4	Black



TELEPHONE STATION CATEGORY 3

CATALOG NUMBER	NO. OF PAIRS	AWG SIZE	COND. STRAND	NOM. INSULATION THICKNESS		NOM. JACKET THICKNESS		NOMINAL O.D.	
				INCHES	mm	INCHES	mm	INCHES	mm
C4413	2	24	Solid	0.007	0.18	0.015	0.38	0.145 x 0.095	3.68 x 2.41

Note: Outdoor rating allows cable to be exposed for short distances from the network interface device on the outside of the house to the point where the cable enters the house. This type of cable is not to be buried or direct buried.

Color Code Chart (Bandmarked)

NO. OF PAIRS	COLOR	NO. OF PAIRS	COLOR
1	White-Blue Band Blue	2	White-Orange Band Orange

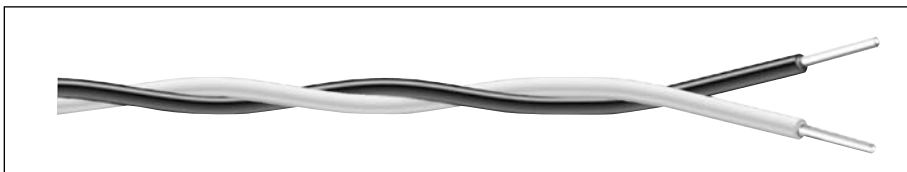

BURGLAR ALARM

CATALOG NUMBER	NO. OF COND.	AWG SIZE	COND. STRAND	NOM. INSULATION THICKNESS		NOMINAL O.D.		NOM.* C-C CAP. pF/ft
				INCHES	mm	INCHES	mm	
C6310	2	22	7/30	0.024	0.61	0.156	3.96	20.0
C6311	2	20	7/28	0.024	0.61	0.172	4.37	22.5
C6312	2	18	7/0.015	0.024	0.61	0.192	4.88	24.5
C6313	3	18	7/0.015	0.024	0.61	0.202	5.13	28.5

*Capacitance between conductors

Color Code Chart

STOCK COLORS	ORDERING SUFFIX	STOCK COLORS	ORDERING SUFFIX
1. White-White	02	3. Black-White	96
2. Brown-Brown	08		

Product Construction:

Conductor:

- Solid or stranded bare copper per ASTM B-3

Insulation:

- Semi-rigid, flame-retardant PVC
- Color code: See chart below

Core:

- Conductors in a quad configuration (C4412)

Jacket:

- Low-temperature, flame-retardant beige PVC (-20°C to +60°C)
- Sequential footage markings to facilitate installation
- Cables are suitable for installation with T-18 staples

Applications:

- Intercom systems and speaker extension service
- Suggested voltage rating: 300 volts
- **C4413 only:** Product is in conformance with TIA 568C, TIA 570B standards and the FCC Part 68 ruling which requires telephone system cables for voice and data services into homes to be at minimum category 3, 2 pr. 22 AWG solid.

Compliances:

- NEC Article 800 Type CMR/CMX-Indoor/Outdoor; UL Listed (60°C, 300V)
- Coil Packs (500') – NEC Article 800 Type CM/CMX-Indoor/Outdoor; ETL Listed
- Coil Packs (500') – NEC Article 725 Type CL2; ETL Listed
- C4413 only, Category 3
- RoHS Compliant Directive 2002/95/EC

Packaging:

- Please contact Customer Service for packaging and color options

Product Construction:

Conductor:

- 22 thru 18 AWG one tinned/one bare fully annealed stranded copper
- Stranded bare copper per ASTM B-3 or stranded tinned copper per ASTM B-33

Insulation:

- Premium-grade, color-coded PVC
- Temperature range: -20°C to +60°C
- Color code: See chart below

Applications:

- Burglar alarms
- Intercom systems
- Remote control circuits
- Suggested voltage rating: 150 volts

Features:

- Polarity ridge for easy identification

Compliances:

- NEC Article 725 Type CL2 (UL: 60°C, 150V)
- RoHS Compliant Directive 2002/95/EC
- Designed to meet UL 70,000 BTU Vertical Tray Flame Test

Packaging:

- Please contact Customer Service for packaging and color options



Designed to Meet UL Vertical Tray Flame Test
Underwriters Laboratories Inc.



Antenna Rotor

Product Construction:

Conductor:

- 22 thru 18 AWG fully annealed stranded bare copper per ASTM B-3

Insulation:

- Premium-grade, color-coded PVC
- Color code: See charts below

Jacket:

- Permaline® polyethylene, black
- Temperature range: -20°C to +60°C

Applications:

- Rotor antenna controls
- Outdoor installations
- Direct burial
- Suggested voltage rating: 200 volts

Features:

- Permaline® jackets resist deterioration
- Sunlight-resistant
- Moisture- and salt-resistant

Compliances:

- RoHS Compliant Directive 2002/95/EC



CATALOG NUMBER	NO. OF COND.	AWG SIZE	COND. STRAND	NOM. INSULATION THICKNESS		NOM. JACKET THICKNESS		NOMINAL O.D.	
				INCHES	mm	INCHES	mm	INCHES	mm
C5076	4	22	7/30	0.010	0.25	0.022	0.56	0.165	4.19
C5086	5	22	7/30	0.010	0.25	0.022	0.56	0.175	4.45
C5096	8	22	7/30	0.010	0.25	0.020	0.51	0.205	5.21
C5078	4	20	10/30	0.009	0.23	0.023	0.58	0.180	4.57
C5460†	2	18	16/30	0.016	0.25	0.020	0.51	0.208	5.28
C5084	4	18	16/30	0.016	0.40	0.030	0.76	0.245	6.22

†Color Code Black/Red

Product Construction:

Conductor:

- 22 thru 16 AWG fully annealed stranded bare copper per ASTM B-3

Insulation:

- Premium-grade, color-coded PVC
- Color code: See chart below

Jacket:

- PVC, chrome gray or black (C4080, C4090)
- Temperature range: -20°C to +80°C

Applications:

- Compatible with Alliance Ham/CB and TV rotors
- Suggested voltage rating: 200 volts

Compliances:

- RoHS Compliant Directive 2002/95/EC

Packaging:

- Please contact Customer Service for packaging and color options



CATALOG NUMBER	NO. OF COND.	AWG SIZE	COND. STRAND	NOM. INSULATION THICKNESS		NOM. JACKET THICKNESS		NOMINAL O.D.	
				INCHES	mm	INCHES	mm	INCHES	mm
C1118	4	22	7/30	0.010	0.25	0.020	0.51	0.161	4.09
C1124	5	22	7/30	0.010	0.25	0.020	0.51	0.175	4.45
C1130	8	22	7/30	0.010	0.25	0.020	0.51	0.205	5.21
C1119	4	20	10/30	0.010	0.25	0.020	0.51	0.180	4.57
C1126	5	20	10/30	0.010	0.25	0.020	0.51	0.197	5.00
C1123	4	18	16/30	0.016	0.40	0.030	0.76	0.255	6.48

COMBINATION ROTOR CABLE

C4080	8	6-22 2-18	7/30 16/30	0.012 0.016	0.30 0.41	0.030	0.76	0.260	6.60
C4090	8	6-20 2-16	10/30 26/30	0.010 0.016	0.25 0.41	0.030	0.76	0.280	7.11

Antenna Rotor Cable Color Code Chart

NO. OF COND.	COLOR
1	Black
2	White
3	Red
4	Green
5	Yellow
6	Blue
7	Brown
8	Orange

Combination Rotor Cable Color Code Chart

NO. OF COND.	COLOR
16/18 ga.	
1	Black
2	Red
20/22 ga.	
1	White
2	Green
3	Yellow
4	Blue
5	Brown
6	Orange



Low-Voltage Sprinkler Wire

60°C 30 Volts UL

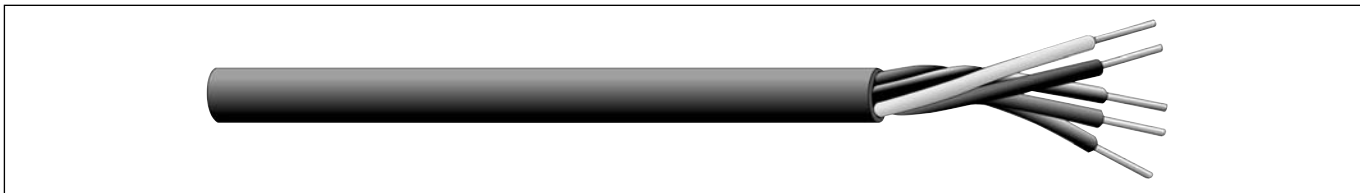

CATALOG NUMBER	NO. OF COND.	AWG SIZE	LENGTH OF CORD (FEET)	PACKAGE TYPE	POWER RATING ⁽¹⁾			PKG PER CTN.	APPROX. WEIGHT PER CTN (LBS) ^(S)	CARTON DIMENSIONS (H x W x D)	UPC NUMBER
					VOLTS	AMPS	WATTS				
LOW VOLTAGE SPRINKLER WIRE - 30 VOLTS - UL											
23824-60-01	4	18	100	Cuff	30	15	450	6	22	8.5 x 12.25 x 14	079407238248
23804-18-01	4	18	500	Spool	30	15	450	1	18	10.625 x 10.625 x 6.313	079407908047
23815-60-01	5	18	50	Cuff	30	15	450	6	13	8.5 x 12.25 x 14	079407238156
23825-60-01	5	18	100	Cuff	30	15	450	6	27	9.5 x 14 x 17	079407238255
23805-18-01	5	18	500	Spool	30	15	450	1	22	10.625 x 10.625 x 6.313	079407908054
23817-60-01	7	18	50	Cuff	30	15	450	6	18	8.5 x 12.25 x 14	079407238170
23827-60-01	7	18	100	Cuff	30	15	450	6	36	9.5 x 14 x 17	079407238279
23807-18-01	7	18	500	Spool	30	15	450	1	31	10.625 x 10.625 x 6.313	079407908078
23810-18-01	10	18	500	Reel	30	15	450	1	44	—	079407908108

(1) Amps and watts are offered ONLY as a guide to the end user.
 (S) Actual shipping weight may vary.

Color Code Chart

NO. OF CONDUCTORS	COLOR
1	Black
2	White
3	Red
4	Green
5	Orange
6	Yellow
7	Blue
8	Brown
9	Gray
10	Purple

Product Construction:

Conductor:

- 18 AWG fully annealed solid bare copper per ASTM B-3

Insulation:

- Premium-grade, color-coded PVC
- Premium-grade PE jacket, black
- Nylon rip cord to facilitate jacket removal
- Temperature range: -20°C to +60°C
- Color code: See chart at right

Jacket Marking:

- CAROL (SIZE) 30V SPRINKLER SYSTEMS WIRE - DIRECT BURIAL E54567 (UL)

Applications:

- Low-voltage golf course satellite sprinkler control
- Residential sprinkler solenoid control

Compliances:

- UL Listed under a UL Miscellaneous Wire file
- UL Listed for outdoors applications
- UL Listed for direct burial applications

Packaging:

- See tabular data above
- Please contact Customer Service for packaging and color options



Thermostat Wire

60°C 30 Volt CSA Type LVT

Product Construction:

Conductors:

- 8 AWG annealed solid bare copper per ASTM B-3

Insulation:

- Premium-grade, color-coded PVC
- Color code: See chart below

Jacket:

- Polyvinylchloride (PVC), brown
- Temperature range: -20°C to +60°C

Jacket Marking:

- CAROL (SIZE) CSA LL# TYPE LVT FT-4

Applications:

- Thermostat control
- Heating and air conditioning installations
- Touch-plate systems
- Burglar alarms
- Intercom systems
- Door bells
- Annunciator and bell systems
- Remote control units
- Signal systems
- Other low-voltage installations

Compliances:

- CSA Type LVT
- RoHS Compliant Directive 2002/95/EC

Packaging:

- Please contact Customer Service for packaging and color options

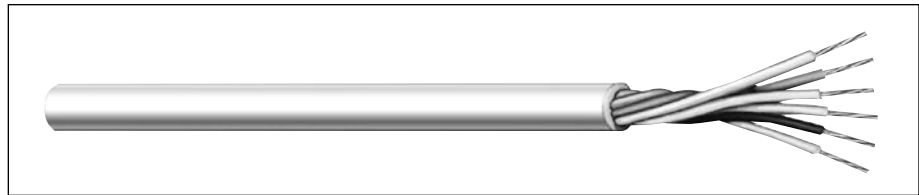

CATALOG NUMBER	NO. OF COND.	AWG SIZE	COND. STRAND	NOM. INSULATION THICKNESS		NOMINAL O.D.		APPROX. NET WEIGHT LBS/m ^(S)	STD. CTN.
				INCHES	mm	INCHES	mm		
18 AWG THERMOSTAT WIRE – 30 VOLT – CSA TYPE LVT									
05092	2	18	Solid	0.017	0.43	0.210	5.33	25	2000'
05093*	3	18	Solid	0.017	0.43	0.222	5.64	33	500'
05094	4	18	Solid	0.017	0.43	0.242	6.15	41	1000'
05095	5	18	Solid	0.017	0.43	0.262	6.65	50	1000'
05096*	6	18	Solid	0.017	0.43	0.280	7.11	60	1000'
05097*	7	18	Solid	0.017	0.43	0.285	7.24	65	1000'
05098*	8	18	Solid	0.017	0.43	0.304	7.75	74	1000'
05099*	9	18	Solid	0.017	0.43	0.328	8.33	83	1000'
05091*	10	18	Solid	0.017	0.43	0.360	9.14	92	250'

*Non-stock item; minimum quantity purchase required.
 (S) Actual shipping weight may vary.

Color Code Chart

NO. OF CONDUCTORS	COLORS
2	White, Red
3	White, Red, Green
4	White, Red, Green, Blue
5	White, Red, Green, Blue, Yellow
6	White, Red, Green, Blue, Yellow, Brown
7	White, Red, Green, Blue, Yellow, Brown, Orange
8	White, Red, Green, Blue, Yellow, Brown, Orange, Black
9	White, Red, Green, Blue, Yellow, Brown, Orange, Black, Purple
10	White, Red, Green, Blue, Yellow, Brown, Orange, Black, Purple, Gray

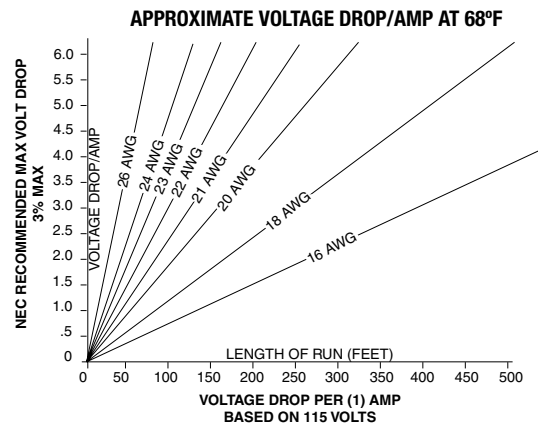

Thermostat Wire

105°C 150 Volt UL Type CL2

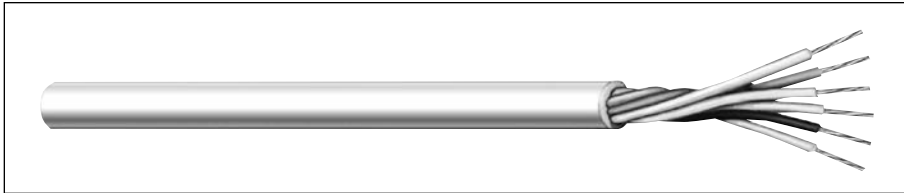

CATALOG NUMBER	NO. OF COND.	AWG SIZE	COND. STRAND	NOM. INSULATION THICKNESS		NOMINAL O.D.		APPROX. NET WEIGHT LBS/m ^(S)	STD. CTN.
				INCHES	mm	INCHES	mm		

20 AWG THERMOSTAT WIRE – 150 VOLT – UL TYPE CL2

05482	2	20	Solid	0.008	0.203	0.128	3.25	11	1000'
05483	3	20	Solid	0.008	0.203	0.135	3.43	16	1000'
05484	4	20	Solid	0.008	0.203	0.144	3.66	19	500'
05485	5	20	Solid	0.008	0.203	0.158	4.01	24	500'
05486	6	20	Solid	0.008	0.203	0.177	4.46	27	500'
05487	7	20	Solid	0.008	0.203	0.175	4.45	31	500'
05488	8	20	Solid	0.008	0.203	0.186	4.72	35	500'
05489	9	20	Solid	0.008	0.203	0.210	5.33	40	500'
05481	10	20	Solid	0.008	0.203	0.235	5.97	45	250'

18 AWG THERMOSTAT WIRE – 150 VOLT – UL TYPE CL2

05582	2	18	Solid	0.009	0.203	0.155	3.94	16	1000'
05583	3	18	Solid	0.009	0.203	0.164	4.17	22	1000'
05584	4	18	Solid	0.009	0.203	0.180	4.57	28	500'
05585	5	18	Solid	0.009	0.203	0.200	5.08	36	500'
05586	6	18	Solid	0.009	0.203	0.215	5.46	42	500'
05587	7	18	Solid	0.009	0.203	0.215	5.46	48	500'
05588	8	18	Solid	0.009	0.203	0.235	5.97	54	500'
05589	9	18	Solid	0.008	0.203	0.245	6.22	61	500'
05581	10	18	Solid	0.008	0.203	0.300	7.62	69	250'

(S) Actual shipping weight may vary.

Color Code Chart

NO. OF CONDUCTORS	COLOR
2	White, Red
3	White, Red, Green
4	White, Red, Green, Blue
5	White, Red, Green, Blue, Yellow
6	White, Red, Green, Blue, Yellow, Brown
7	White, Red, Green, Blue, Yellow, Brown, Orange
8	White, Red, Green, Blue, Yellow, Brown, Orange, Black
9	White, Red, Green, Blue, Yellow, Brown, Orange, Black, Purple
10	White, Red, Green, Blue, Yellow, Brown, Orange, Black, Purple, Gray

Product Construction:

Conductors:

- 20 and 18 AWG annealed solid bare copper per ASTM B-3

Insulation:

- Premium-grade, color-coded PVC
- Color code: See chart below

Jacket:

- Polyvinylchloride (PVC), white
- Temperature range: -20°C to +105°C

Jacket Marking:

- CAROL AWG TYPE CL2 E# (UL)
105°C SUNLIGHT RESISTANT - MADE IN USA

Applications:

- Thermostat control
- Heating and air conditioning installations
- Touch-plate systems
- Burglar alarms
- Intercom systems
- Door bells
- Annunciator and bell systems
- Remote control units
- Signal systems
- Other low-voltage installations

Industry Approvals:

- UL Listed Type CL2

Compliances:

- RoHS Compliant Directive 2002/95/EC

Packaging:

- Please contact Customer Service for packaging and color options

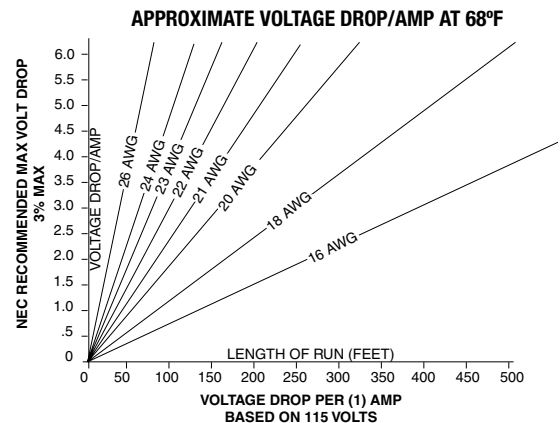

Thermostat Wire, Unjacketed

60°C Low Voltage and Intercom Cable

Product Construction:

Conductors:

- 20 AWG annealed solid bare copper per ASTM B-3

Insulation:

- Premium-grade, color-coded PVC
- Temperature range: -20°C to +60°C
- Color code: See chart below

Jacket:

- This product is unjacketed

Applications:

- Thermostat control
- Heating and air conditioning installations
- Touch-plate systems
- Burglar alarms
- Intercom systems
- Door bells
- Annunciator and bell systems
- Remote control units
- Signal systems
- Other low-voltage installations

Packaging:

- Please contact Customer Service for packaging and color options

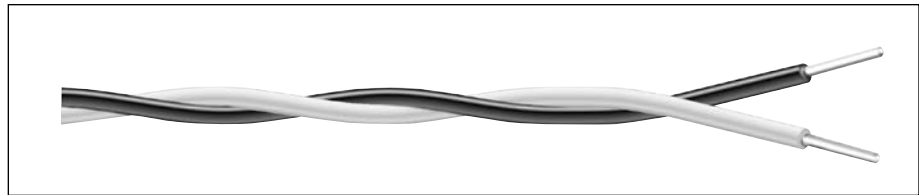

CATALOG NUMBER	NO. OF COND.	AWG SIZE	COND. STRAND	NOM. INSULATION THICKNESS		NOMINAL O.D.		APPROX. NET WEIGHT LBS/m ^(S)	STD. CTN.
				INCHES	mm	INCHES	mm		

20 AWG – TWISTED CONDUCTORS – NO JACKET

05782	2	20	Solid	0.008	0.203	0.098	2.49	7.5	4000'
05783	3	20	Solid	0.008	0.203	0.106	2.69	11.0	2000'
05784*	4	20	Solid	0.008	0.203	0.119	3.01	15.0	2000'
05785*	5	20	Solid	0.008	0.203	0.133	3.38	18.5	1000'
05786*	6	20	Solid	0.008	0.203	0.147	3.73	22.0	1000'
05788*	8	20	Solid	0.008	0.203	0.162	4.11	30.0	1000'

*Non-stock item; minimum quantity purchase required.
(S) Actual shipping weight may vary.

Color Code Chart

NO. OF CONDUCTORS	COLOR
2	White, Red
3	White, Red, Green
4	White, Red, Green, Blue
5	White, Red, Green, Blue, Yellow
6	White, Red, Green, Blue, Yellow, Brown
8	White, Red, Green, Blue, Yellow, Brown, Orange, Black

Carol® Helix/Hi-Temp® Category 6 Cable

Standard-Compliant Solution

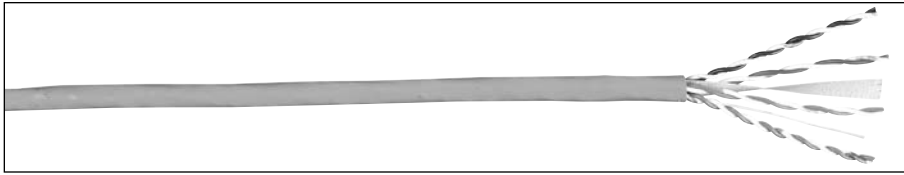

PART NUMBERS

JACKET COLOR	PULL-PAC® II		SPOOL-PAC®	
	CMR (NON-PLENUM)	CMP (PLENUM)	CMR (NON-PLENUM)	CMP (PLENUM)
Blue	CR6.30.07	CP6.30.07	CR6.A3.07	CP6.A3.07
White	CR6.30.02	CP6.30.02	CR6.A3.02	CP6.A3.02
Gray	CR6.30.10	CP6.30.10	CR6.A3.10	CP6.A3.10
Green	CR6.30.06	CP6.30.06	CR6.A3.06	CP6.A3.06
Yellow	CR6.30.05	CP6.30.05	CR6.A3.05	CP6.A3.05
Red	CR6.30.03	CP6.30.03	CR6.A3.03	CP6.A3.03

ELECTRICAL PERFORMANCE

FREQUENCY MHZ	PSACR (MIN)	ACR (MIN)	ATTENUATION (MAX)	PSNEXT (MIN)	NEXT (MIN)	PSELFEXT (MIN)	ELFEXT (MIN)	RETURN LOSS (MIN)	LCL (MIN)	ELTCTL (MIN)
1	70.3	72.3	2.0	72.3	74.3	64.8	67.8	20.0	40.0	35.0
4	59.3	61.5	3.8	63.3	65.3	52.8	55.7	23.0	40.0	23.0
10	51.3	53.3	6.0	57.3	59.3	44.8	47.8	25.0	40.0	15.0
16	46.7	48.7	7.6	54.2	56.2	40.7	43.7	25.0	38.0	10.9
20	44.3	46.3	8.5	52.8	54.8	38.8	41.7	25.0	37.0	9.0
31.25	39.2	41.2	10.7	49.9	51.9	34.9	37.9	23.6	35.1	5.1
62.5	29.9	32.0	15.4	45.4	47.4	28.9	31.8	21.5	32.0	5.0
100	22.5	24.5	19.8	42.3	44.3	24.8	27.8	20.1	30.0	5.0
150	14.9	16.9	24.7	39.7	41.7	21.3	24.3	18.9	28.2	5.0
200	8.8	10.8	29.0	37.8	39.8	18.8	21.8	18.0	27.0	5.0
250	3.5	5.5	32.8	36.3	38.3	16.8	19.8	17.3	26.0	5.0
350	—	—	39.8	34.1	36.1	13.9	16.9	16.3	—	—
400	—	—	43.0	33.3	35.3	12.8	15.8	15.9	—	—
500	—	—	48.9	31.8	33.8	10.8	13.8	15.2	—	—

Notes: Values are expressed in dB per 100m (328 ft.) length. Values above 250 MHz are for informational purposes only.

PHYSICAL DATA

	CMR (NON-PLENUM)	CMP (PLENUM)
Nominal Cable Diameter (in)	0.205	0.200
Nominal Cable Weight (lbs/1000ft)	28	28
Minimum Bend Radius (in)	1.0	1.0
Maximum Pulling Force (lbs)	32	32
Temperature Rating (°C)		
Installation:	0 to +60	0 to +60
Operation:	-20 to +75	-20 to +75

ELECTRICAL CHARACTERISTICS

DC Resistance (max) Ohms/100m (328ft) @ 20°C	9.38
DC Resistance Unbalance (max) Individual Pair %	4.0
Delay Skew (max) ns/100m	45
Nom. Velocity of Propagation % Speed of Light	CMP: 70 CMR: 68
Characteristic Impedance	Ohms
Frequency (f):	1-250 MHz 100 ± 15
Input Impedance	Ohms
Frequency (f):	1-100 MHz 100 ± 15 100-250 MHz 100 ± 22

Data subject to change without notice.

Product Construction:

Conductors:

- 23 AWG solid bare annealed copper

Separator

- Tape

Insulation

- Non-Plenum: Polyolefin
- Plenum: Fluoropolymer

Rip Cord

- Applied longitudinally under jacket

Jacket

- Non-Plenum: flame-retardant PVC
- Plenum: low-smoke, flame-retardant PVC
- TRU-Mark® print legend contains footage markings from 1000' to 0'

Applications:

- IEEE 802.3: 1000 BASE-T (Gigabit Ethernet), 100 BASE-TX, 10 BASE-T
- ANSI/TIA/EIA 854: 1000 BASE-TX
- 155 Mp/s, 1.2 Gb/s ATM
- ANSI X3.263: 100 Mb/s
- IEEE 802.3af DTE Power (PoE)
- Digital video

Compliances:

- ANSI/TIA/EIA 568 B.2-1 (Category 6)
- ANSI/TIA/EIA 862 (Building Automation)
- ISO/IEC 11801 Ed. 2.0 (Class E)
- ICEA S-102-700 (Category 6)
- UL & c(UL) Type CMP (NFPA 262 and CSA FT-6 Steiner Tunnel Fire Tests for Plenum Applications)
- UL 444
- RoHS Compliant Directive 2002/95/EC
- Third-party verified for guaranteed performance

Packaging:

- 1000' Pull-Pac® II
- 1000' Spool-Pac®

CATEGORY 6 CROSS-SECTION

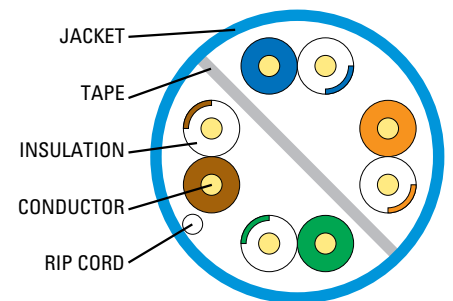

Helix/HiTemp®



Designed to Meet
NFPA 262 and CSA FT-6
Steiner Tunnel Fire Tests
for Plenum Applications

Underwriters Laboratories Inc.



Carol® Helix/Hi-Temp® Category 5e Cable

Enhanced Transmission Throughput

Product Construction:

Conductors:

- 24 AWG solid bare annealed copper

Insulation

- Non-Plenum: Polyolefin
- Plenum: Fluoropolymer

Rip Cord

- Applied longitudinally under jacket

Jacket

- Non-Plenum: flame-retardant PVC
- Plenum: low-smoke, flame-retardant PVC
- TRU-Mark® print legend contains footage markings from 1000' to 0'

Applications:

- IEEE 802.3: 1000 BASE-T (Gigabit Ethernet), 100 BASE-TX, 10 BASE-T
- 52/155 Mp/s ATM
- ANSI X3.263: 100 Mb/s
- 4/16 Mp/s token ring

Compliances:

- ANSI/TIA/EIA 568 B.2 (Category 5e)
- ICEA S-90-661 (Category 5e)
- UL & c(UL) Type CMR (UL 1666) for Non-Plenum
- UL & c(UL) Type CMP (NFPA 262 and CSA FT-6 Steiner Tunnel Fire Tests for Plenum Applications)
- UL 444
- RoHS Compliant Directive 2002/95/EC
- Third-party verified for guaranteed performance

Packaging:

- 1000' Pull-Pac® II
- 1000' Spool-Pac®

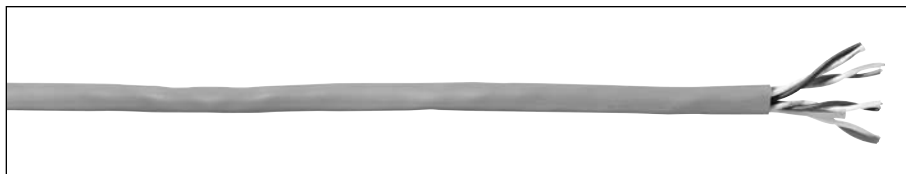

PART NUMBERS

JACKET COLOR	PULL-PAC® II		SPOOL-PAC®	
	CMR (NON-PLENUM)	CMP (PLENUM)	CMR (NON-PLENUM)	CMP (PLENUM)
Blue	CR5.30.07	CP5.30.07	CR5.A3.07	CP5.A3.07
White	CR5.30.02	CP5.30.02	CR5.A3.02	CP5.A3.02
Gray	CR5.30.10	CP5.30.10	CR5.A3.10	CP5.A3.10
Green	CR5.30.06	CP5.30.06	CR5.A3.06	CP5.A3.06
Yellow	CR5.30.05	CP5.30.05	CR5.A3.05	CP5.A3.05
Red	CR5.30.03	CP5.30.03	CR5.A3.03	CP5.A3.03

ELECTRICAL PERFORMANCE

FREQUENCY MHZ	PSACR (MIN)	ACR (MIN)	ATTENUATION (MAX)	PSNEXT (MIN)	NEXT (MIN)	PSELFEXT (MIN)	ELFEXT (MIN)	RETURN LOSS (MIN)
1	60.3	63.3	2.0	62.3	65.3	60.8	63.8	20.0
4	49.2	52.2	4.1	53.3	56.3	48.7	51.7	23.0
10	40.8	43.8	6.5	47.3	50.3	40.8	43.8	25.0
16	36.0	39.0	8.2	44.2	47.2	36.7	39.7	25.0
20	33.5	36.5	9.3	42.8	45.8	34.7	37.7	25.0
25	30.9	33.9	10.4	41.3	44.3	32.8	35.8	24.3
31.25	28.2	31.2	11.7	39.9	42.9	30.9	33.9	23.6
62.5	18.4	21.4	17.0	35.4	38.4	24.8	27.8	21.5
100	10.3	13.3	22.0	32.3	35.3	20.8	23.8	20.1
155	1.4	4.4	28.1	29.4	32.4	16.9	19.9	—
200	—	—	32.4	27.8	30.8	14.7	17.7	—
250	—	—	36.9	26.3	29.3	12.8	15.8	—
350	—	—	44.9	24.1	27.1	9.9	12.9	—

Notes: Values are expressed in dB per 100m (328 ft.) length. Values above 250 MHz are for informational purposes only.

PHYSICAL DATA

	CMR (NON-PLENUM)	CMP (PLENUM)
Nominal Cable Diameter (in)	0.200	0.180
Nominal Cable Weight (lbs/1000ft)	21	19
Minimum Bend Radius (in)	1.0	1.0
Maximum Pulling Force (lbs)	25	25
Temperature Rating (°C)		
Installation:	0 to +60	0 to +60
Operation:	-10 to +60	-10 to +60

ELECTRICAL CHARACTERISTICS

DC Resistance (max) Ohms/100m (328ft) @ 20°C	8.9
DC Resistance Unbalance (max) Individual Pair %	3.0
Mutual Capacitance (nom) pF/ft @ 1 KHz	14
Delay Skew (max) ns/100m	45
Nom. Velocity of Propagation % Speed of Light	CMP: 72 CMR: 70
Characteristic Impedance Frequency (f):	1-100 MHz Ohms 100 ± 15

Data subject to change without notice.

CATEGORY 5e CROSS-SECTION

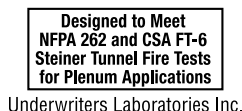
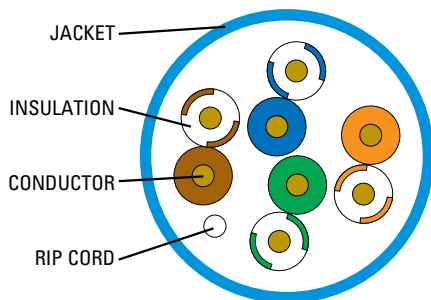

Audio/Video & Home Entertainment Cable

8

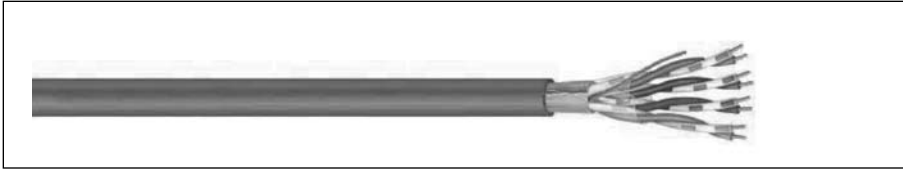

General Cable offers a variety of Carol® Brand wire and cable for audio/video and direct burial applications. From field production cable to microphone, snake, guitar and speaker cable, General Cable supports the increasingly demanding entertainment industry.

For extreme hard service, General Cable's rubber microphone cables offer the ultimate in performance and service life. The rubber designs are highly flexible and designed to lie flat on studio floors, as well as provide high impact and abrasion resistance.

For outdoor and cold weather applications, microphone cable jacketed with Carolprene® provides the ultimate protection against ozone, oil and ultraviolet radiation.

These technically sophisticated cables are required to contain sources of interference and to protect against difficulties where they are unavoidable. In addition to providing the needed electrical characteristics, the cables are properly designed to handle demanding conditions, such as microphone hum, handling noise, crosstalk, electrostatic hum, SCR noise and common ground noise—either on stage, in a studio or at a remote venue.

For more information on these cables or for other special applications, please contact your General Cable sales representative.

Index	Page
Command® Series Home Entertainment Cables Guide	147-148
Command® Series Cruise Ship Cables Guide	149-150
Command® Series Speaker Cable	151-155
Speaker Wire	156
Superflex® Speaker Wire	157
Pro Audio Speaker Wire	158
Special Audio, Communication & Instrumentation	159-161
Low Skew 4-Pair UTP	162
SmartWrap™ Bundled Cable	163
Direct Burial, Audio & Communication	164-165
Digital Audio Snake Cable	166
Analog Audio Snake Cable	167-168
Guitar/Instrument Cable	169
Ultra Flexible, Low Impedance 2-Conductor Microphone Cable	170
Multi-Conductor, Flexfoil® Shield	171
Multi-Conductor, Rubber, Braid Shield Microphone Cable	172
Multi-Conductor, Spiral Shield	173
Multi-Conductor, Braid Shield	174
Microphone Cable, Multi-Conductor, Carolprene®, Braid Shield	175
SMPTE-311 Hybrid Fiber Optic/ Copper Camera Cable	176
Electronic News Gathering/Field Production Camera Cable	177

ELECTRONICS
WIRE & CABLE

Command® Series Home Entertainment Cables



Carol® Brand Command® Series Speaker Cables offer outstanding performance at an affordable price. The cables are highly flexible and available in a wide variety of options for in-wall use for home theaters as well as high definition applications. Whether your choice of speaker cable is constructed with Oxygen-Free Copper (OFC) or the more universally accepted Tough Pitch Copper (ETP), your speaker system will perform as designed and to your expectations.

- OFC copper is defined as 99.95% pure. The refining process provides reduced oxygen content and other impurities.
- High Conductive Electrolytic Tough Pitch Copper is the most widely used refined copper within the electronic cable industry. It is defined as 99.9%-99.94% oxygen-free and provides the same level of conductivity as OFC.

There are a number of considerations to be made when choosing the proper speaker cable:

- Choose the proper AWG size for your system design (Speaker Impedance, 4 or 8 ohm) and acceptable loss for the required cable distance.
- Choose an acceptable stranding that will provide both ease of installation and flexibility.
- Choose a cable that is appropriate to the installation relative to any building standards or codes.
 1. UL/CSA
 2. NEC Riser, Plenum
- Select individual jacket colors as necessary to contribute to room or circuit identification.
- Most importantly, choose the cable that you feel comfortable with. If you are convinced that OFC provides a benefit that you can hear, select our OFC product. If you choose our speaker cables that utilize our high-conductive ETP, you will have selected a cable with the same resistance for equal cable run distances. The cable resistance is the primary selection criteria.

Command® Series PREMIUM-Grade Speaker Cable NEC Type CL2

Applications:

Digital audio with high strand, rope lay construction for superior flexibility

Catalog No.	Conductors	AWG (Stranding)	Length
C1458.55.90	2	16 (105 x 36)	25' Coil
C1458.56.90	2	16 (105 x 36)	50' Coil
C1458.57.90	2	16 (105 x 36)	100' Coil
C1458.15.90	2	16 (105 x 36)	250' Spool
C1461.55.90	2	14 (105 x 34)	25' Coil
C1461.56.90	2	14 (105 x 34)	50' Coil
C1461.57.90	2	14 (105 x 34)	100' Coil
C1461.15.90	2	14 (105 x 34)	250' Spool
C1463.55.90	2	12 (259 x 36)	25' Coil
C1463.56.90	2	12 (259 x 36)	50' Coil
C1463.15.90	2	12 (259 x 36)	250' Spool

Command® Series Home Entertainment Speaker Cable NEC Type CL3, CM, AWM 1/11 A/B

Applications:

In-wall speakers and home theater systems

Catalog No.	Conductors	AWG (Stranding)	Length
C1700	2	12 (65 x 30)	500' Boxes
C1701	4	12 (65 x 30)	500' Boxes
C1702	2	14 (41 x 30)	500' Boxes
C1703	4	14 (41 x 30)	500' Boxes
C1704	2	16 (26 x 30)	500' Boxes
C1705	4	16 (26 x 30)	500' Boxes

Command® Series "HIGH DEF" Home Entertainment Speaker Cable NEC Type CL3, CM, AWM 1/11 A/B

Applications:

High definition, flexible in-wall speakers and home theater systems

Features:

Oxygen-Free Cu Conductors
Semi-extruded jacket provides a uniform round cable construction

Catalog No.	Conductors	AWG (Stranding)	Length
C1800	2	12 (105 x 32)	500' Reels
C1801	4	12 (105 x 32)	500' Reels
C1802	2	14 (105 x 34)	500' Boxes
C1803	4	14 (105 x 34)	500' Reels
C1804	2	16 (65 x 34)	500' Boxes
C1805	4	16 (65 x 34)	500' Boxes

Command® Series Home Entertainment Cables



Command® Series Speaker Wire UL Listed (Wires, Misc)

Applications:	Catalog No.	Conductors	AWG (Stranding)	Length
Digital audio, stereo systems	C1356	2	24 (7 x 32)	500' Reels
	C1362	2	22 (7 x 30)	500' Reels
	C1360	2	20 (10 x 30)	500' Reels
	C1357	2	18 (16 x 30)	500' Reels
	C1358	2	16 (26 x 30)	500' Reels
	C1361	2	14 (41 x 30)	500' Reels
	C1363	2	12 (65 x 30)	500' Reels

Command® Series Twisted Pair Speaker Cable NEC Type CMR

Applications:	Catalog No.	Conductors	AWG (Stranding)	Length
Home theaters, home audio systems	C1000A	2	22 (7 x 30)	500' Reels
	C1001A	2	20 (7 x 28)	500' Reels
	C1002A	2	18 (7 x 26)	500' Reels
	C1003A	2	16 (19 x 29)	500' Reels
	C1004A	2	14 (42 x 30)	500' Reels
	C1005A	2	12 (65 x 30)	500' Reels

Commercial-Grade Speaker Cables NEC Type CMR

Applications:	Catalog No.	Conductors	AWG (Stranding)	Length
Movie theaters, commercial sound installations	E1042S	2	16 (19/.0117)	500' Reels
	E1044S	4	16 (19/.0117)	500' Reels
	E1052S	2	14 (19/.0147)	500' Reels
	E1054S	4	14 (19/.0147)	500' Reels
	E1062S	2	12 (19/.0185)	500' Reels
	E1064S	4	12 (19/.0185)	500' Reels

Rubber Jacketed Microphone Cable—High- and Low-Impedance

Applications:	Catalog No.	Conductors	AWG
Low- and high-impedance microphones, broadcast and studio use, communication and audio systems, shielded power supplies, control circuits, video and audio interconnecting cables, suggested voltage rating of 300	C1300	1	#20 (26 x 34)
	C1301	2	#18 (41 x 34)
	C1302	2	#20 (26 x 34)



Command® Series Cruise Ship Cables

**CAROL
BRAND**



**ELECTRONICS
WIRE & CABLE**

General Cable's Carol® Brand Command Series Cruise Ship Cables are manufactured for use on cruise ships and yachts. These cables, which contain low smoke, zero halogen jackets, are designed to deliver premier audio, video and data communications capabilities aboard marine vessels.

The Carol Brand Command Series Cruise Ship Cables are RoHS compliant and approved by the American Bureau of Shipping (ABS) for use in marine applications.

ABS is the leading international organization committed to promoting the security of life, property and the natural environment primarily through the development and verification of standards for the design, construction and operational maintenance of marine-related facilities. Their stamp on Carol Brand Command Series Cruise Ship Cables means that our cables have been certified for product compliance and will perform reliably in marine and off-shore environments. For more information on ABS, please visit: www.eagle.org

When your cruise ship or yacht project requires high-quality performance, think of Carol Brand Command Series Cruise Ship Cables.

You can always *Demand Better...Expect More™* with General Cable Carol Brand Electronic cables. We manufacture over 1,300 standard electronic cables that we can ship direct from stock, and we have the technical staff and design expertise to meet any customer cable requirement.



Special Application Cable

Hook-Up Wire

Plenum Cable

Coaxial Cable

Microphone Cable

Computer Cable

General Purpose Cable

Multi-Conductor Communication
& Control Cable

Multi-Paired Communication
& Control Cable

Fire Alarm Cable

Sound & Security Cable

 **General Cable**

RoHS Compliant
Directive 2002/95/EC

 **ABS**
FOUNDED 1892

 **UL** US
LISTED

**CAROL
BRAND**

Command® Series Cruise Ship Cables

ABS Listed



Carol® Brand Command® Series Audio Control & Instrumentation Cable—Multi-Pair, Foil Shield

PART NUMBER	NO. OF PAIRS	AWG SIZE	COND. STRAND.	JACKET TYPE	JACKET COLOR/TEMPERATURE	NOMINAL O.D.		INSULATION TYPE	INSULATION THICKNESS		CONDUCTOR COLOR CODE	NOM. CAP.* pF/FT	
						INCHES	mm		INCHES	mm		A	B
C2520ACS	1 Pair	22	7/30 Tinned Copper	Flame Retardant Low Smoke Halogen Free Polyolefin PVC	Black/-30°C +75°C	0.162	4.11	-40°C to +105°C Polypropylene	0.008	0.20	Black - Red	35	67
C1352ACS	2 Pair	22	7/30 Tinned Copper	Flame Retardant Low Smoke Halogen Free Polyolefin PVC	Black/-30°C +75°C	0.196	4.98	-40°C to +105°C Polypropylene	0.008	0.20	P1: Black - Red, P2: Green - White	35	62
C6040ACS	3 Pair	22	7/30 Tinned Copper	Flame Retardant Low Smoke Halogen Free Polyolefin PVC	Black/-30°C +75°C	0.270	6.86	-40°C to +105°C Polypropylene	0.010	0.25	P1: Black - Red, P2: Black - White, P3: Black - Green	30	55

APPROVALS - (UL) c(UL) Listed Communication Cable Type CMG-LS 75°C, ABS Listed, & RoHS Compliant

*A - Capacitance between conductors

*B - Capacitance between one conductor and other conductors connected to the shield

Carol® Brand Command® Series RG-6 Coaxial Cable

PART NUMBER	DESCRIPTION	JACKET TYPE	JACKET COLOR/TEMPERATURE	NOMINAL O.D.		INSULATION TYPE	INSULATION THICKNESS		NOM. IMP. (Ω)	NOMINAL VEL. OF PROP.	NOM. CAP.** pF/FT	NOMINAL ATTENUATION			
				INCHES	mm		INCHES	mm				MHz	dB/100 FT	MHz	dB/100 FT
C5775ACS	18 AWG Solid Copper-Clad Steel, Dual Shielded, CATV Coaxial Cable	Flame Retardant Low Smoke Halogen Free Polyolefin PVC	Black/-30°C +75°C	0.274	6.96	Gas Injected Foam Polyethylene	0.0700	1.78	75±3	83%	16.2	5.00	0.67	550	4.71
												55.00	1.60	750	5.59
												211.00	2.87	870	6.00
												270.00	3.24	1000	6.54
												300.00	3.43	1450	8.30
												350.00	3.72	1800	9.30
												400.00	4.00	2250	10.60
450.00	4.26	3000	11.90												
C5814ACS	18 AWG Solid Bare Copper, Dual Shielded, Video Coaxial Cable	Flame Retardant Low Smoke Halogen Free Polyolefin PVC	Black/-30°C +75°C	0.274	6.96	Gas Injected Foam Polyethylene	0.0700	1.78	75	82%	16.2	1.00	0.24	270	2.97
												3.58	0.45	360	3.43
												5.00	0.54	540	4.25
												7.00	0.63	720	4.95
												10.00	0.72	750	5.00
												67.50	1.57	1000	5.89
												71.50	1.60	1500	7.33
												88.50	1.75	2000	8.57
												100.00	1.84	2250	9.14
												135.00	2.10	3000	10.67
												143.00	2.16	4500	13.29
												180.00	2.42	—	—
												C8029ACS	Element 1 - 18 AWG Solid Bare Copper, Video Coaxial Cable	Flame Retardant Low Smoke Halogen Free Polyolefin PVC	Black/-30°C +75°C
5.00	0.45	400	4.30												
10.00	0.64	700	5.80												
50.00	1.46	900	6.70												
100.00	2.10	1000	7.10												
C8029ACS	Element 2 - 2 Cond. 18 AWG 7/.0152" Stranded Bare Copper, Power Pair	Flame Retardant Low Smoke Halogen Free Polyolefin PVC	Black/-30°C +75°C	0.186	4.72	-40°C to +105°C Polypropylene	0.0065	0.17	—	—	24**	—	—	—	—
												—	—	—	—

APPROVALS - (UL) c(UL) Listed Communication Cable Type CMG-LS 75°C, ABS Listed, & RoHS Compliant

** Capacitance between conductors

Carol® Brand Command® Series Category 5e Cable

PART NUMBER	DESCRIPTION	JACKET TYPE	JACKET COLOR/TEMPERATURE	NOMINAL O.D.		INSULATION TYPE	INSULATION THICKNESS		CONDUCTOR COLOR CODE	INPUT IMP. (Ω)	FREQUENCY	P5CAR	ACR	ATTENUATION	PSNEXT	NEXT	PSELFEXT	ELFEXT	RL	
				INCHES	mm		INCHES	mm				MIN.	MIN.	MAX.	MIN.	MIN.	MIN.	MIN.	MIN.	
				VALUES ARE EXPRESSED IN dB PER 100m (328 FT) LENGTH																
CR5ACS	4 Pair 24 AWG Solid Bare Copper ScTP Category 5e Cable	Flame Retardant Low Smoke Halogen Free Polyolefin PVC	Black/-20°C +75°C	0.260	6.60	Polyolefin	0.010	0.25	P1: White/Blue - Blue P2: White/Orange - Orange P3: White/Green - Green P4: White/Brown - Brown	100±15	0.772	62.2	65.2	2.0	64.0	67.0	63.0	66.0	—	
												1.000	60.3	63.3	1.8	62.3	65.3	60.8	63.8	20.0
												4.000	49.2	52.2	4.1	53.3	56.3	48.7	51.7	23.0
												8.000	43.0	46.0	5.8	48.8	51.8	42.7	45.7	24.5
												10.000	40.8	43.8	6.5	47.3	50.3	40.8	43.8	25.0
												16.000	36.1	39.1	8.2	44.3	47.3	36.7	39.7	25.0
												20.000	33.5	36.5	9.3	42.8	45.8	34.7	37.7	25.0
												25.000	30.9	33.9	10.4	41.3	44.3	32.8	35.8	24.3
												31.250	28.2	31.2	11.7	39.9	42.9	30.9	33.9	23.6
												62.500	18.4	21.4	17.0	35.4	38.4	24.8	27.8	21.5
												100.000	10.3	13.3	22.0	32.3	35.3	20.8	23.8	20.1

APPROVALS - (UL) c(UL) Listed Communication Cable Type CMG-LS 75°C, ABS Listed, & RoHS Compliant



Command® Series Premium Grade Speaker Cable

NEC Type CL2



Product Description:

Command® Series Premium Grade Speaker Cable was designed to offer outstanding performance at an affordable price. The cables are highly flexible and can be used for in-wall installations, making them ideal for use in home theater systems.

The Premium Grade Speaker Cable is available in 250' spools for custom-cut lengths, and in 25-, 50- and 100-foot clamshells. The packaged cables are ideal for display on pegboard, gondolas or H-frame shelves.

Product Construction:

Conductor:

- 16 through 12 AWG fully annealed stranded bare copper conductor per ASTM B-3

Insulation:

- Premium-grade, clear PVC
- Temperature range: -20°C to +60°C

Applications:

- Digital audio
- Stereo systems
- In-wall speakers
- Home theater

Features:

- High-strand, rope-lay conductors give the cable extra flexibility
- Convenient footage and polarity markers, at one-foot intervals to make installation easy
- Paintable to match any décor

Compliances:

- NEC Article 725 Type CL2
- RoHS Compliant Directive 2002/95/EC

CATALOG NUMBER	NO. OF COND.	AWG SIZE	COND. STRAND	LENGTH	COLOR OF JACKET	PACKAGE TYPE	PKG PER CARTON	CARTON WEIGHT (LBS)	CARTON DIMENSIONS (H x W x D)	CARTON CUBE	UPC NUMBER
16 AWG CONDUCTORS											
C1458.55.90	2	16	66/34	25'	Clear	Coil	6	6.4	12.5 x 8.1 x 10.0	0.586	0 79407 76307 8
C1458.56.90	2	16	66/34	50'	Clear	Coil	6	10.4	12.5 x 8.1 x 10.0	0.586	0 79407 76308 5
C1458.57.90	2	16	66/34	100'	Clear	Coil	6	18.6	15.5 x 8.1 x 10.0	0.727	0 79407 76309 2
C1458.15.90	2	16	66/34	250'	Clear	Spool	1	8.5	6.6 x 6.6 x 6.3	0.159	0 79407 76273 6
14 AWG CONDUCTORS											
C1461.55.90	2	14	105/34	25'	Clear	Coil	6	8.5	12.5 x 8.1 x 10.0	0.586	0 79407 76310 8
C1461.56.90	2	14	105/34	50'	Clear	Coil	6	14.5	12.5 x 8.1 x 10.0	0.586	0 79407 76311 5
C1461.57.90	2	14	105/34	100'	Clear	Coil	6	27.0	15.5 x 8.1 x 10.0	0.727	0 79407 76312 2
C1461.15.90	2	14	105/34	250'	Clear	Spool	1	11.5	6.6 x 6.6 x 6.3	0.159	0 79407 76274 3
12 AWG CONDUCTORS											
C1463.55.90	2	12	259/36	25'	Clear	Coil	6	11.8	12.5 x 8.1 x 10.0	0.586	0 79407 76313 9
C1463.56.90	2	12	259/36	50'	Clear	Coil	6	21.4	15.5 x 8.1 x 10.0	0.727	0 79407 76314 6
C1463.15.90	2	12	259/36	250'	Clear	Spool	1	17.5	13.0 x 6.5 x 9.5	0.464	0 79407 76275 0

Command® Series Home Entertainment Speaker Cable

NEC Type CL3, CSA, CMG, AWM I/II A/B

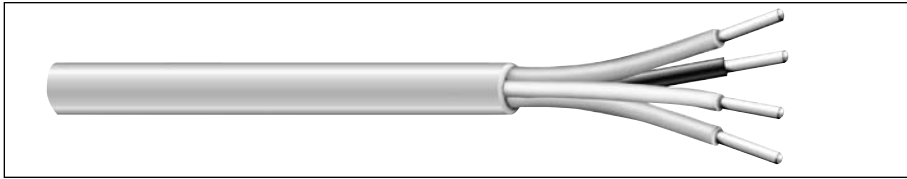

CATALOG NUMBER	NO. OF COND.	AWG SIZE	COND. STRAND	NOM. INSULATION WALL		NOM. JACKET THICKNESS		NOMINAL O.D.	
				INCHES	mm	INCHES	mm	INCHES	mm
C1700†	2	12	65/30	0.009	0.15	0.021	0.53	0.254	6.45
C1701†	4	12	65/30	0.009	0.15	0.021	0.53	0.299	7.59
C1702†	2	14	41/30	0.009	0.15	0.021	0.53	0.220	5.59
C1703†	4	14	41/30	0.009	0.15	0.021	0.53	0.257	6.53
C1704	2	16	26/30	0.009	0.15	0.021	0.53	0.191	4.85
C1705	4	16	26/30	0.009	0.15	0.021	0.53	0.222	5.64

†CL3, CSA AWM I/II A/B only

Color Code Chart

NO. OF COND.	COLOR
1	Black
2	Red
3	White
4	Green

Product Construction:

Conductor:

- 12, 14, 16, or 18 AWG fully annealed, stranded bare copper per ASTM B-8

Insulation:

- Premium-grade, color-coded polypropylene
- Color code: See chart below

Jacket:

- PVC, command blue
- Temperature range: -20°C to +60°C

Applications:

- Digital audio
- Stereo systems
- In-wall speakers
- Home theater
- Remote control circuits
- Security systems
- Bi-amp speakers

Features:

- Flexible

Compliances:

- NEC Article 725 Type CL3 (UL: 60°C)
- CSA, CMG, AWM I/II A/B
- RoHS Compliant Directive 2002/95/EC
- Designed to meet UL 70,000 BTU Vertical Tray Flame Test
- Passes CSA FT-4 Vertical Flame Test

Packaging:

- Please contact Customer Service for packaging and color options



Command® Series OFHC Home Entertainment Speaker Cable

CL3 (UL), CM (UL) c(UL), CSA, CMG, CSA TYPE AWM

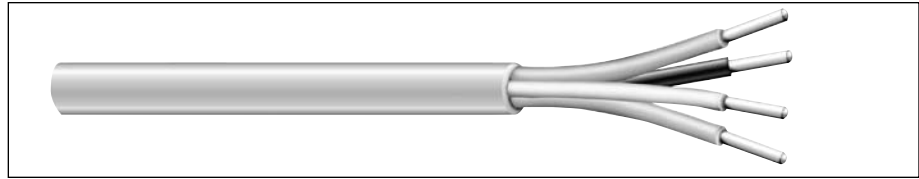

Product Construction:

Conductor:

- 16-12 AWG fully annealed, stranded oxygen-free high conductivity bare copper per ASTM B-170

Insulation:

- Premium-grade, color-coded polypropylene

Jacket:

- PVC, command blue
- Temperature range: -20°C to +60°C

Applications:

- Digital audio
- Stereo systems
- In-wall speakers
- Home theater
- Remote control circuits
- Security systems
- Bi-amp speakers

Features:

- Flexible
- High conductivity, oxygen-free

Compliances:

- NEC Article 725 Type CL3 (UL: 60°C)
- NEC Article 800 Type CM (UL: 60°C)
- CSA, CMG, (CSA: 80°C, 600V)
- RoHS Compliant Directive 2002/95/EC
- Designed to meet UL 70,000 BTU Vertical Tray Flame Test
- Passes CSA FT-4 Vertical Flame Test

Packaging:

- Please contact Customer Service for packaging and color options

CATALOG NUMBER	NO. OF COND.	AWG SIZE	COND. STRAND	NOM. INSULATION THICKNESS		NOM. JACKET THICKNESS		NOMINAL O.D.		NOM. C-C CAP* pF/ft
				INCHES	mm	INCHES	mm	INCHES	mm	
C1800**	2	12	105/32	0.009	0.23	0.021	0.53	0.264	6.71	25.5
C1801**	4	12	105/32	0.009	0.23	0.021	0.53	0.311	7.90	25.5
C1802**	2	14	105/34	0.009	0.23	0.021	0.53	0.226	5.74	23.8
C1803**	4	14	105/34	0.009	0.23	0.021	0.53	0.265	6.73	23.8
C1804	2	16	64/34	0.009	0.23	0.021	0.53	0.196	4.98	22.1
C1805	4	16	65/34	0.009	0.23	0.021	0.53	0.228	5.79	22.1

*Capacitance between conductors
 **NEC Type CL3 and CSA Type AWM Only

Color Code Chart

NO. OF COND.	COLOR
1	Black
2	Red
3	White
4	Green

Command® Series Twisted Pair Speaker Cable

CMR (UL) c(UL) or CL3 (UL), AWM Style 2587

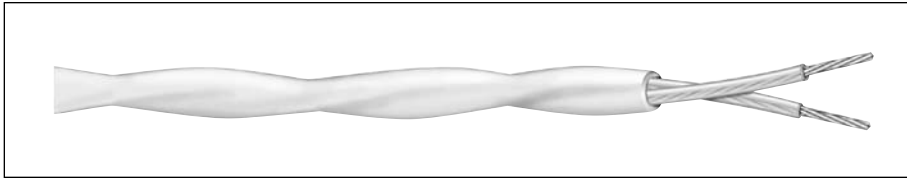

CATALOG NUMBER	NO. OF COND.	AWG SIZE	COND. STRAND	NOM. INSULATION THICKNESS		NOM. JACKET THICKNESS		NOMINAL O.D.		NOM. C-C CAP.* pF/ft
				INCHES	mm	INCHES	mm	INCHES	mm	
NEC Type CMR										
C1000A	2	22	7/30	0.015	0.38	0.025	0.64	0.170	4.32	20.6
C1001A	2	20	7/28	0.013	0.33	0.025	0.64	0.178	4.52	24.5
C1002A	2	18	7/26	0.022	0.56	0.028	0.71	0.235	5.97	21.3
C1003A	2	16	19/0117	0.023	0.58	0.032	0.81	0.274	6.96	23.5
NEC Type CL3, UL Style 2587 (600V)										
C1004A*	2	14	41/30	0.031	0.79	0.032	0.81	0.340	8.64	30.3
C1005A*	2	12	65/30	0.032	0.81	0.035	0.89	0.386	9.80	32.6

*Capacitance between conductors.

Color Code Chart
C1000A-C1001A

NO. OF COND.	COLORS
1	Black
2	Red

C1002A-C1005A

NO. OF COND.	COLORS
1	Black
2	White

Product Construction:

Conductor:

- 22-12 AWG fully annealed stranded tinned copper per ASTM B-33

Insulation:

- Premium-grade, color-coded PVC
- Premium-grade, color-coded S-R PVC

Jacket:

- PVC, white
- Temperature range: -20°C to +75°C

Applications:

- Digital audio
- Stereo systems
- In-wall speakers
- Suggested voltage rating: 300 volts

Compliances:

- NEC Article 800 Type CMR (UL, c(UL): 75°C)
- NEC Article 725 Type CL3 (UL, c(UL): 105°C)
- UL, c(UL) AWM Style 2587 (UL, c(UL): 90°C)
- RoHS Compliant Directive 2002/95/EC
- Designed to meet UL 70,000 BTU Vertical Tray Flame Test

Packaging and Jacket Colors:

- Please consult Customer Service for packaging and color options



Command® Series Studio Grade Speaker Cable

NEC Type CL2



Product Description:

Command® Series Studio Grade Speaker Cable brings sounds to life. It is engineered to deliver the true fidelity of a music signal from the source to the speaker—maintaining the highest signal integrity for ultimate clarity. It is the perfect speaker cable for the discriminating audiophile.

Product Construction:

Conductor:

- 16 through 12 AWG fully annealed stranded silver-plated conductor per ASTM B-3

Insulation:

- Premium-grade, clear blue PVC
- Temperature range: 0°C to +60°C

Applications:

- Digital audio
- Stereo systems
- In-wall speakers

Features:

- Silver-plated conductor lowers electrical resistance for superior signal rendition
- High-strand, rope-lay conductors give the cable extra flexibility
- Convenient footage and polarity markers, at one-foot intervals to make installation easy
- Paintable to match any décor

Compliances:

- NEC Article 725 Type CL2
- RoHS Compliant Directive 2002/95/EC

CATALOG NUMBER	NO. OF COND.	AWG SIZE	COND. STRAND	LENGTH	COLOR OF JACKET	PACKAGE TYPE	PKG PER CARTON	CARTON WEIGHT (LBS)	CARTON DIMENSIONS (H x W x D)	CARTON CUBE	UPC NUMBER
16 AWG CONDUCTORS											
C1558.15.92	2	16	105/36	250'	Clear Blue	Spool	1	8.5	6.6 x 6.6 x 6.3	0.159	0 79407 76276 7
14 AWG CONDUCTORS											
C1561.15.92	2	14	168/36	250'	Clear Blue	Spool	1	11.5	6.6 x 6.6 x 6.3	0.159	0 79407 76280 4
12 AWG CONDUCTORS											
C1563.15.92	2	12	259/36	250'	Clear Blue	Spool	1	17.5	13.0 x 6.5 x 9.5	0.464	0 79407 76280 4

Speaker Wire

UL Listed or AWM Style 1007

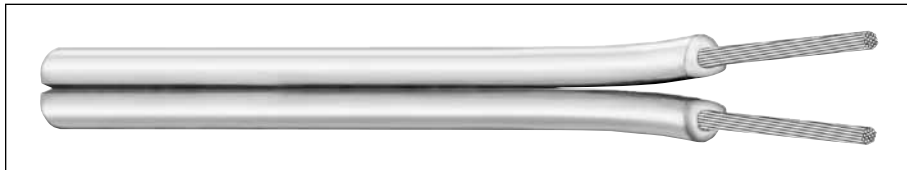

CATALOG NUMBER	NUMBER OF COND.	AWG SIZE	COND. STRAND	NOM. INSULATION THICKNESS		NOMINAL O.D.	
				INCHES	mm	INCHES	mm
UL LISTED (60°C)							
C1356	2	24	7/32	0.016	0.41	0.058x0.117	1.47x2.79
C1362	2	22	7/30	0.020	0.51	0.070x0.145	1.77x3.68
C1360	2	20	10/30	0.020	0.51	0.085x0.160	2.16x4.06
C1357	2	18	16/30	0.020	0.51	0.083x0.181	2.11x4.60
C1358	2	16	26/30	0.020	0.51	0.105x0.210	2.67x5.33
C1361	2	14	41/30	0.025	0.64	0.125x0.235	3.18x5.69
C1363	2	12	65/30	0.025	0.64	0.154x0.323	3.91x8.20

Color Code Chart

ORDERING SUFFIX	COLORS
01	Black
02	White
08	Brown
10	Gray
90	Clear

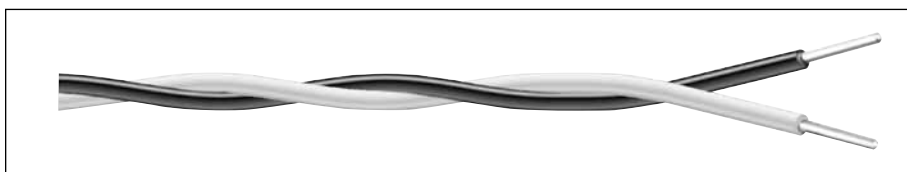

CATALOG NUMBER	NO. OF COND.	AWG SIZE	COND. STRAND	NOM. INSULATION THICKNESS		NOMINAL O.D.	
				INCHES	mm	INCHES	mm
AWM STYLE 1007 (80°C, 300 V)							
C7102A	2	18	7/.0152	0.020	0.51	0.172	4.37

Color Code Chart

ORDERING SUFFIX	STOCK COLOR
99	Black-White

Product Construction:

Conductor:

- 24 thru 12 AWG fully annealed one bare, one tin stranded copper per ASTM B-174

Insulation/Jacket:

- Premium-grade PVC
- Color code: See chart below

Applications:

- Digital audio
- Hi-fi and stereo speaker wire
- Jukeboxes
- Not for in-wall use
- Home theater

Compliances:

- UL Wires Misc.
- RoHS Compliant Directive 2002/95/EC

Packaging:

- Please contact Customer Service for packaging and color options

Product Construction:

Conductor:

- 18 AWG tinned annealed stranded copper
- Stranded tinned copper per ASTM B-33

Insulation:

- Premium-grade, color-coded PVC
- Temperature range: -30°C to +80°C
- Color code: See chart below

Applications:

- Audio systems
- Not for in-wall use

Compliances:

- UL Style 1007 (UL: 80°C, 300 V)

Packaging:

- 1000' (305 m) reels



Superflex® Speaker Wire

UL Listed

Product Construction:

Conductor:

- 12 AWG fully annealed stranded bare copper conductor per ASTM B-3

Insulation/Jacket:

- Premium-grade, clear Superflex® PVC
- Temperature range: -20°C to +60°C
- Color code: See chart below

Applications:

- Digital audio
- Hi-fi and stereo speaker wire
- Jukeboxes
- Not for in-wall use

Compliances:

- UL Misc. (UL: 120V)
- RoHS Compliant Directive 2002/95/EC

Packaging:

- Please contact Customer Service for packaging and color options

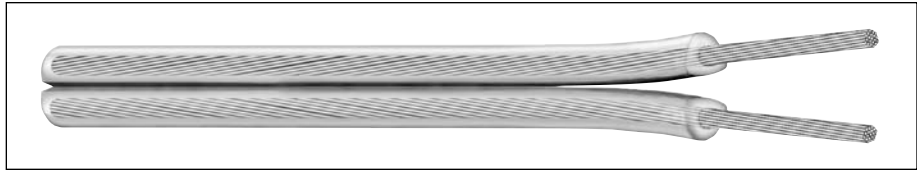

CATALOG NUMBER	NUMBER OF COND.	AWG SIZE	COND. STRAND	NOM. INSULATION THICKNESS		NOMINAL O.D.	
				INCHES	mm	INCHES	mm
C1364	2	12	7x37/36	0.060	1.52	0.220x0.456	5.59x11.58

Color Code Chart

ORDERING SUFFIX	STOCK COLOR
90	Clear

Product Construction:

Conductor:

- 18 AWG, 1 tinned and 1 bare copper conductor per ASTM B-174

Insulation:

- Premium-grade, clear PVC

Jacket:

- PVC, clear
- Temperature range: -20°C to +60°C

Applications:

- Digital audio
- Hi-fi and stereo speaker wire
- Jukeboxes

Compliances:

- RoHS Compliant Directive 2002/95/EC

Packaging:

- Please contact Customer Service for packaging and color options

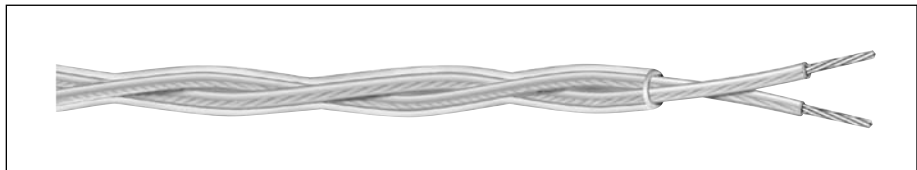

CATALOG NUMBER	NO. OF COND.	AWG SIZE	COND. STRAND	NOM. INSULATION THICKNESS		NOM. JACKET THICKNESS		NOMINAL O.D.	
				INCHES	mm	INCHES	mm	INCHES	mm
C6367	2	18	16/30	0.016	0.41	0.025	0.64	0.210	5.33

Color Code Chart

ORDERING SUFFIX	STOCK COLOR
90	Clear

Pro Audio Speaker Wire

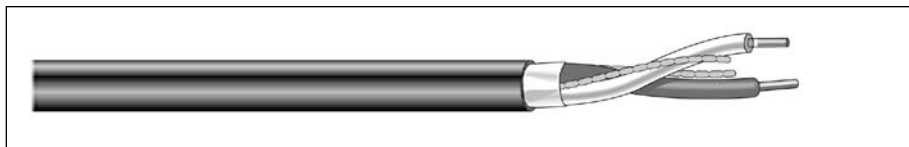

CATALOG NUMBER	CONDUCTOR & O.D.	INSULATION & O.D.	JACKET & O.D.	WEIGHT LBS/Mft
740002	2/C 12 AWG Stranded 65/30 Bare Copper	PVC 0.136" Nom.	PVC 0.365" Nom.	100
740102	2/C 14 AWG Stranded 41/30 Bare Copper	PVC 0.118" Nom.	PVC 0.295" Nom.	75
740202	2/C 16 AWG Stranded 26/30 Bare Copper	PVC 0.102" Nom.	PVC 0.295" Nom.	60
740302	2/C 18 AWG Stranded 41/34 Bare Copper	PVC 0.079" Nom.	PVC 0.235" Nom.	38

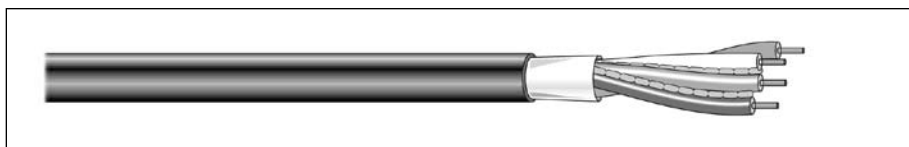

CATALOG NUMBER	CONDUCTOR & O.D.	INSULATION & O.D.	JACKET & O.D.	WEIGHT LBS/Mft
740004	4/C 12 AWG Stranded 65/30 Bare Copper	PVC 0.136" Nom.	PVC 0.463" Nom.	165
740104	4/C 14 AWG Stranded 41/30 Bare Copper	PVC 0.118" Nom.	PVC 0.397" Nom.	107
740204	4/C 16 AWG Stranded 26/30 Bare Copper	PVC 0.102" Nom.	PVC 0.338" Nom.	75
740304	4/C 18 AWG Stranded 41/34 Bare Copper	PVC 0.079" Nom.	PVC 0.283" Nom.	53

NOTE: Cabled with jute fillers and paper tape under jacket.

Color Code Chart

NO. OF COND.	COLOR
1	Black
2	White
3	Red
4	Green

Product Construction:

Conductor:

- 12-18 AWG stranded bare copper
- Twisted pairs

Insulation:

- PVC

Jacket:

- PVC, matte black
- High flexibility

Applications:

- Recording studios
- Commercial broadcast facilities
- Not for in-wall use

Features:

- High durability and long-lasting service

Packaging and Jacket Colors:

- Please consult Customer Service for packaging, color options and agency approvals

Special Audio, Communication & Instrumentation

UL 2095, 2093

Product Construction:

Conductor:

- 24 thru 20 AWG fully annealed stranded tinned copper per ASTM B-33

Insulation:

- Premium-grade, color-coded polyethylene (C1333A) or PVC (C1345A)
- Color code: See chart below

Shield:

- 100% Flexfoil® aluminum/polyester foil with 25% overlap, minimum, foil facing out
- Stranded tinned copper drain wire

Jacket:

- PVC, gray
- Temperature range: -20°C to +80°C

Applications:

- Audio
- Communications
- EMI isolated circuits for instrumentation
- Suggested voltage rating: 300 volts

Compliances:

- UL Style 2093 (UL: 60°C, 300V)
- UL Style 2095 (UL: 80°C, 300V)
- RoHS Compliant Directive 2002/95/EC

Packaging:

- Please contact Customer Service for packaging and color options

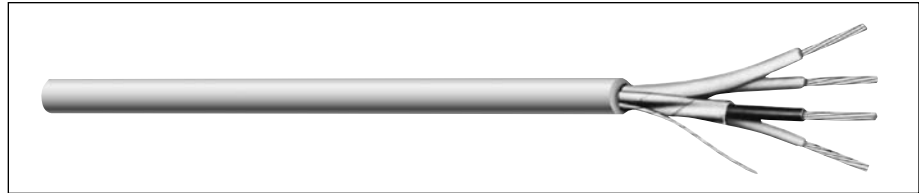

CATALOG NUMBER	NO. OF COND.	AWG SIZE	COND. STRAND	NOM. INSULATION THICKNESS		NOM. JACKET THICKNESS		NOMINAL O.D.		NOM. CAP.* pF/ft	
				INCHES	mm	INCHES	mm	INCHES	mm	A	B
UL Style 2093, 300 VOLT											
C1333A	3	2-20 Shielded 1-20 Unshielded	10/30	0.015	0.38	0.028	0.71	0.206	5.23	26.0	47.0
			7/28	0.016	0.41						

*A – Capacitance between conductors

*B – Capacitance between one conductor and other conductors connected to shield

Color Code Chart

NO. OF COND.	COLOR
Shielded	
1	Black
2	Red
Unshielded	
1	Natural

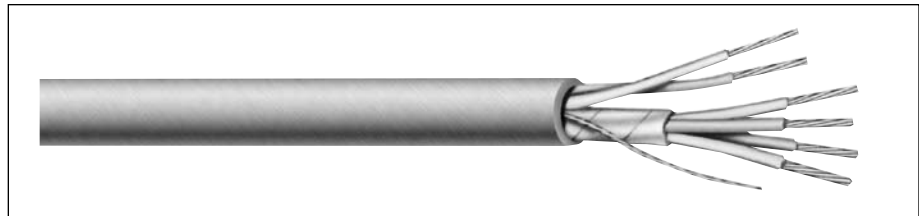

CATALOG NUMBER	NO. OF COND.	AWG SIZE	COND. STRAND	NOM. INSULATION THICKNESS		NOM. JACKET THICKNESS		NOMINAL O.D.		NOM. CAP.* pF/ft	
				INCHES	mm	INCHES	mm	INCHES	mm	A	B
UL Style 2095, 300 VOLT											
C1345A	6	4-24 Shielded 2-22 Unshielded	7/32	0.015	0.38	0.025	0.64	0.230	5.84	32.0	57.0
			7/30								

*A – Capacitance between conductors

*B – Capacitance between one conductor and other conductors connected to shield

Color Code Chart

NO. OF COND.	COLOR
Shielded	
1	Black
2	Red
3	Green
4	Yellow
Unshielded	
1	Blue
2	White

Special Audio, Communication & Instrumentation

UL 2095, UL 2835, UL 2094, NEC Type CL2

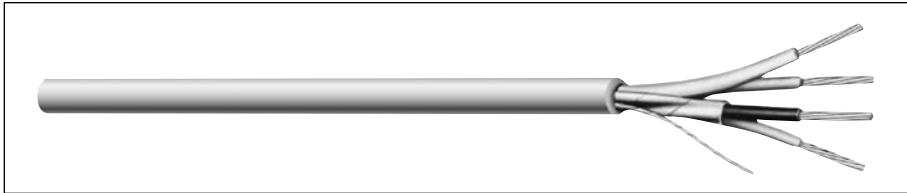

Product Construction:

Conductor:

- 22 thru 18 AWG fully annealed stranded tinned copper per ASTM B-33

Insulation:

- C1331A - Premium-grade, color-coded PVC
- C1340A - Premium-grade, color-coded polypropylene
- C1343A - Premium-grade, color-coded polyethylene
- Color code: See chart below

Shield:

- 100% Flexfoil® aluminum/polyester over two conductors, 25% overlap, minimum, foil facing out
- Stranded tinned copper drain wire

Jacket:

- PVC, gray
- Temperature range: -20°C to +80°C

Applications:

- Audio
- Communications
- EMI isolated circuits for instrumentation

Compliances:

- Nec Article 725 Type CL2 (UL: 75°C, 150V)
- C1331A - UL Style 2095 (UL: 80°C)
- C1340A - UL Style 2835 (UL: 60°C)
- C1343A - UL Style 2094 (UL: 60°C)
- RoHS Compliant Directive 2002/95/EC
- Designed to meet UL 70,000 BTU Vertical Tray Flame Test

Packaging:

- Please contact Customer Service for packaging and color options

CATALOG NUMBER	NO. OF COND.	AWG SIZE	COND. STRAND	NOM. INSULATION THICKNESS		NOM. JACKET THICKNESS		NOMINAL O.D.		NOM. CAP.*	
				INCHES	mm	INCHES	mm	INCHES	mm	A	B

UL Style 2095, NEC Type CL2

C1331A	4	2-20 Shielded 2-20 Unshielded	7/28	0.016	0.41	0.032	0.81	0.230	5.84	41.0	74.0
---------------	---	----------------------------------	------	-------	------	-------	------	-------	------	------	------

UL Style 2835

C1340A	4	2-22 Shielded 2-22 Unshielded	7/30	0.008	0.20	0.017	0.43	0.161	4.09	29.0	52.0
---------------	---	----------------------------------	------	-------	------	-------	------	-------	------	------	------

UL Style 2094

C1343A	4	2-20 Shielded 2-18 Unshielded	7/28 16/30	0.018	0.46	0.032	0.81	0.259	6.58	27.0	49.0
---------------	---	----------------------------------	---------------	-------	------	-------	------	-------	------	------	------

*A - Capacitance between conductors

*B - Capacitance between one conductor and other conductors connected to shield

Color Code Chart

NO. OF COND.	COLOR
Shielded	
1	Black
2	Red
Unshielded	
1	Green
2	White



Designed to Meet
UL Vertical Tray
Flame Test

Underwriters Laboratories Inc.



Special Audio, Communication & Instrumentation

UL 2094

Product Construction:

Conductor:

- 22 AWG fully annealed stranded tinned copper per ASTM B-33

Insulation:

- Premium-grade, color-coded polyethylene
- Color code: See chart below

Shield:

- 64% tinned copper braid over one pair

Jacket:

- PVC, gray
- Temperature range: -20°C to +60°C

Applications:

- Special audio
- Communication and control
- Instrumentation
- Applications where total isolation of signal is required
- Suggested voltage rating: 300 volts

Compliances:

- UL Style 2094 (UL: 60°C, 300V)
- RoHS Compliant Directive 2002/95/EC
- Designed to meet UL VW-1 Vertical Wire Flame Test

Packaging:

- Please contact Customer Service for packaging and color options

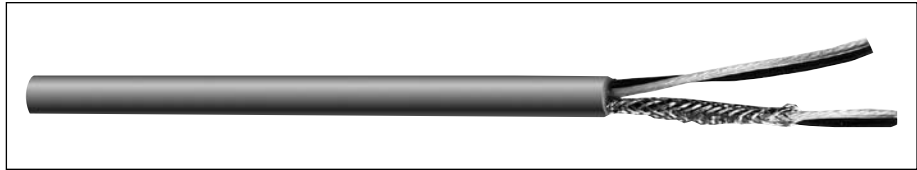

CATALOG NUMBER	NO. OF PAIRS	AWG SIZE	COND. STRAND	NOM. INSULATION THICKNESS		NOM. JACKET THICKNESS		NOMINAL O.D.		NOM. CAP.*	
				INCHES	mm	INCHES	mm	INCHES	mm	A	B
C1338A	2	1-22 Shielded 1-22 Unshielded	7/30	0.015	0.38	0.030	0.76	0.295	7.49	24.0	43.0

*A – Capacitance between conductors

*B – Capacitance between one conductor and other conductors connected to shield

Color Code Chart

NO. OF PAIRS	COLOR
1	Black/Natural
2	Black/Natural

Low Skew 4-Pair UTP

NEC Type CMR/CMP (UL), c(UL)

Product Construction:

Conductor:

- 23 or 24 AWG solid bare copper

Insulation:

- Fluorinated ethylene propylene (FEP)
- High density propylene (HDPE)

Jacket:

- Plenum - Flexguard® green
- Riser - PVC maroon

Applications:

- Suitable for RGB video applications
- Digital CCTV cameras

Compliances:

- NEC Article 800 Type CMR (UL), c(UL)
- NEC Article 800 Type CMP (UL), c(UL)

Packaging:

- 1000' Pull-Pacs®
- Contact Customer Service for additional packaging options

Color Code Chart

NO. OF PAIRS	COLOR
1	White/Blue Stripe and Blue
2	White/Orange Stripe and Orange
3	White/Green Stripe and Green
4	White/Brown Stripe and Brown

CATALOG NUMBER	AWG SIZE	NOMINAL DCR	NOMINAL O.D. (INCHES)	INSULATION MATERIAL		NOMINAL IMPEDANCE OHMS	PROPAGATION DELAY SKEW	NOMINAL ATTENUATION		BELDEN PART NO.
				INCHES	mm			MHz	dB/328 ft.	
E3842S CMP	24 AWG Solid Bare Copper	27.4 Ω/Mft	0.185	Fluorinated Ethylene Propylene (FEP)		100	2.2 ns/328 ft.	1 4 8 10 16 20 25 31.25 62.50 100 155 200 250* 300* 350*	2.0 4.1 5.8 6.5 8.2 9.3 10.4 11.7 17.0 22.0 28.1 32.0 36.4 41.0 44.8	7987P
				0.035	0.9					
E1842S CMR	24 AWG Solid Bare Copper	27.4 Ω/Mft	0.185	High Density Propylene (HDPE)		100	2.2 ns/328 ft.	1 4 8 10 16 20 25 31.25 62.50 100 155 200 250* 300* 350*	2.0 4.1 5.8 6.5 8.2 9.3 10.4 11.7 17.0 22.0 28.1 32.0 36.4 41.0 44.8	7987R
				0.035	0.9					
E3843S CMP	23 AWG Solid Bare Copper	22.0 Ω/Mft	0.200	Fluorinated Ethylene Propylene (FEP)		100	2.2 ns/328 ft.	1 4 8 10 16 20 25 31.25 62.50 100 155 200 250 300* 350*	2.0 3.8 5.3 6.0 7.6 8.5 9.5 10.7 15.4 19.8 25.2 29.0 32.8 35.2 39.8	7989P
				0.040	1.0					
E1843S CMR	23 AWG Solid Bare Copper	22.0 Ω/Mft	0.213	High Density Propylene (HDPE)		100	2.2 ns/328 ft.	1 4 8 10 16 20 25 31.25 62.50 100 155 200 250* 300* 350*	2.0 3.8 5.3 6.0 7.6 8.5 9.5 10.7 15.4 19.8 25.2 29.0 32.8 35.2 39.8	7989R
				0.040	1.0					

*For information only.



SmartWrap™ Bundled Cable

Multiple Cable Types Depending On Application Up to 6 Cables / Jacketed and Unjacketed

Product Construction:

Fiber:

- Multimode or singlemode fibers with easily strippable 900µm tight buffering colored per TIA/EIA 598
- Cabled with aramid yarn strength member and jacketed to meet appropriate standards

Coax:

- Quad shield RG6 coax with copper-clad steel center conductor, either foamed PE (riser) or FEP (plenum) dielectric and overall PVC jacket

Twisted Pair:

- Unshielded or shielded twisted pair that meets or exceeds all TIA/EIA 568 B-2 standards for Carol® Brand Cat 5e

Binder:

- Helically wound polyester binder

Overall Jacket (Optional):

- Riser-rated versions use a flame-retardant PVC

Applications:

- SmartWrap™ cables are several different cables available with either helical binding or overall jacketing to allow simultaneous pulling of multiple cables. Configurations include combinations of Cat 5e UTP or ScTP, RG6 video/data quad shield coax and optical fiber cables. Plenum and riser versions available

Features:

- Many cables can be pulled at once—faster installation
- TIA/EIA 568 B-2 Crosstalk-compliant
- Simplifies cable management
- Excellent for residential applications

Compliances:

- NEC Article 800 CMR, CSA FT-4 riser
- NEC Article 800 CMP, CSA FT-6 plenum

Packaging:

- Please contact Customer Service for packaging and color options

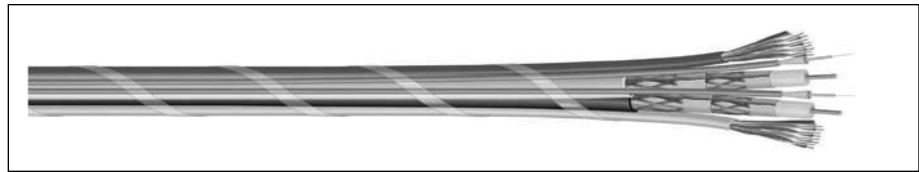

CATALOG NUMBER	SAFETY RATING	BINDING OR JACKET	CONSTRUCTION
710021	Riser	Binding	4 Carol® Brand Cat 5e UTP
810021	Plenum	Binding	4 Carol® Brand Cat 5e UTP
710022	Riser	Binding	6 Carol® Brand Cat 5e UTP
810022	Plenum	Binding	6 Carol® Brand Cat 5e UTP
710023	Riser	Binding	4 Carol® Brand Cat 5e ScTP
810023	Plenum	Binding	4 Carol® Brand Cat 5e ScTP
710024	Riser	Binding	6 Carol® Brand Cat 5e ScTP
810024	Plenum	Binding	6 Carol® Brand Cat 5e ScTP
710010	Riser	Jacket	2 Carol® Brand Cat 5e UTP and 2 RG6 Quad Smart Home coax
710011	Riser	Jacket	2 Carol® Brand Cat 5e UTP, 2 RG6 Quad Smart Home coax and 2 simplex multimode fiber cables
710017	Riser	Binding	2 Carol® Brand Cat 5e UTP and 2 RG6 Quad Smart Home coax
710018	Riser	Binding	2 Carol® Brand Cat 5e UTP, 2 RG6 Quad Smart Home coax and 2 simplex multimode fiber cables

The above listings are for stock cables. Custom configurations are available. Information is subject to change without notice. Consult Customer Service for a variety of alternate constructions for specific applications.

DATA TRANSMISSION PERFORMANCE FOR CAT 5E CABLES

FREQUENCY (MHZ)	INSERTION LOSS TYPICAL • MAX* (dB/100m)	NEXT TYPICAL • MIN* (dB)	PSNEXT TYPICAL • MIN* (dB)	ACR TYPICAL • MIN* (dB/100m)	PSACR TYPICAL • MIN* (dB/100m)	ELFEXT TYPICAL • MIN* (dB/100m)	PSNEXT TYPICAL • MIN* (dB/100m)	RETURN LOSS MIN (dB)
1	19.3 • 22.0	51.9 • 35.3	43.8 • 32.3	32.6 • 13.3	24.5 • 10.3	43.7 • 23.8	38.8 • 20.8	20.1

*Max/min measurements match TIA/EIA 568 B-2 standards

ELECTRICAL CHARACTERISTICS FOR CAT 5E CABLES

DC Resistance	≤9.38 Ohms/100 Meters • 28.6 Ohms/1000 Feet	Input Impedance	100 Ohms ± 15% @ 1 - 100 MHz
DCR Unbalanced	≤5%	Propagation Delay (Skew)	45 nanoseconds/100 meters max
Mutual Capacitance	≤55.8 pF/m • 17 pF/ft	Velocity of Propagation	72% plenum/69% riser

ELECTRICAL CHARACTERISTICS FOR RG6 CABLES

Capacitance	≤53.2 pF/m • 16.2 pF/ft	Attenuation (dB/100 ft)	0.21@ 1 MHz • 6.04 dB @ 1000MHz
Characteristic Impedance	75 Ohms	Velocity of Propagation	83% riser

Direct Burial, Audio & Communication

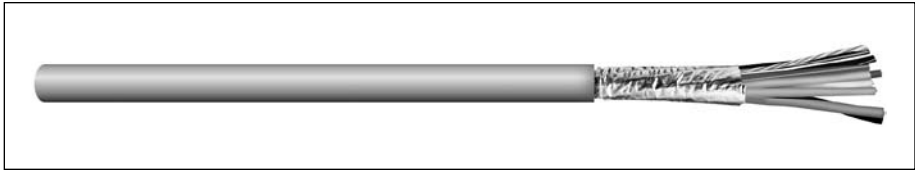

CATALOG NUMBER	NO. OF COND.	AWG SIZE	COND. STRAND	NOM. INSULATION THICKNESS		NOM. JACKET THICKNESS		NOMINAL O.D.		NOM. CAP* pF/ft	
				INCHES	mm	INCHES	mm	INCHES	mm	A	B
C2509A	2	20	Solid	0.013	0.33	0.037	0.94	0.190	4.83	25.0	44.0
C2510A	3	20	Solid	0.013	0.33	0.039	0.99	0.205	5.21	22.0	40.0
C2511A	10	20	Solid	0.013	0.33	0.039	0.99	0.310	7.87	20.5	37.0

*A – Capacitance between conductors

*B – Capacitance between one conductor and other conductors connected to shield

Product Construction:

Conductor:

- 20 AWG fully annealed solid tinned copper per ASTM B-33

Insulation:

- Premium-grade, color-coded polypropylene

Shield:

- 100% Flexfoil® aluminum/polyester with 25% overlap, minimum, foil facing out
- Solid tinned copper drain wire

Jacket:

- Permaline® high-density polyethylene, black
- Temperature range: -20°C to +80°C

Applications:

- Suitable for direct burial
- Outdoor uses
- 100% shielded cable where RF shielding is required
- Suggested voltage rating: 350 volts

Features:

- Permaline® jackets resist deterioration
- Sunlight-resistant
- Highly durable jacket

Compliances:

- RoHS Compliant Directive 2002/95/EC

Packaging:

- Please contact Customer Service for packaging and color options

Direct Burial, Audio & Communication

Product Construction:

Conductor:

- 20 AWG fully annealed stranded tinned copper per ASTM B-33
- Twisted pairs

Insulation:

- Premium-grade, color-coded polypropylene
- Color code: See chart below

Shield:

- 100% Flexfoil® aluminum/polyester with 25% overlap, minimum, foil facing in
- Stranded tinned copper drain wire each pair
- Individually shielded pairs

Jacket:

- Permaline® high-density polyethylene, black
- Temperature range: -20°C to +80°C

Applications:

- Suitable for direct burial
- Outdoor uses
- Applications where total isolation of signal is required
- Suggested voltage rating: 350 volts

Features:

- Permaline® jackets resist deterioration
- Sunlight-resistant

Compliances:

- RoHS Compliant Directive 2002/95/EC

Packaging:

- Please contact Customer Service for packaging and color options

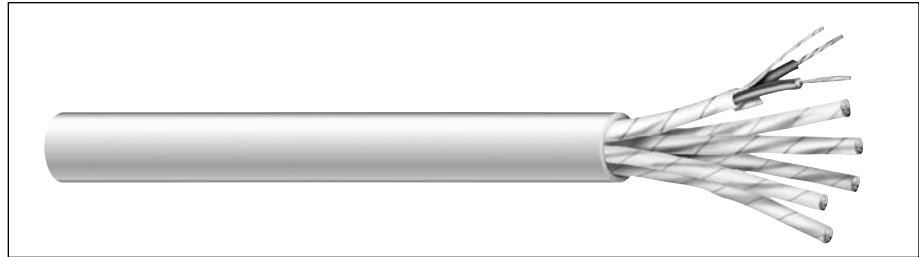

CATALOG NUMBER	NO. OF PAIRS	AWG SIZE	COND. STRAND	NOM. INSULATION THICKNESS		NOM. JACKET THICKNESS		NOMINAL O.D.		NOM. CAP.*	
				INCHES	mm	INCHES	mm	INCHES	mm	A	B
C6061A	3	20	10/30	0.013	0.33	0.047	1.19	0.340	8.64	22.0	39.0
C6062A	6	20	10/30	0.013	0.33	0.047	1.19	0.442	11.23	22.0	39.0

*A – Capacitance between conductors

*B – Capacitance between one conductor and other conductors connected to shield

Color Code Chart

NO. OF PAIRS	COLOR
1	Black paired with Red
2	Black paired with White
3	Black paired with Green
4	Black paired with Blue
5	Black paired with Yellow
6	Black paired with Brown

Digital Audio Snake Cable

AES/EBU 110 Ohm Multi-Pair Individually Shielded & Jacketed, NEC Type CM/CL2

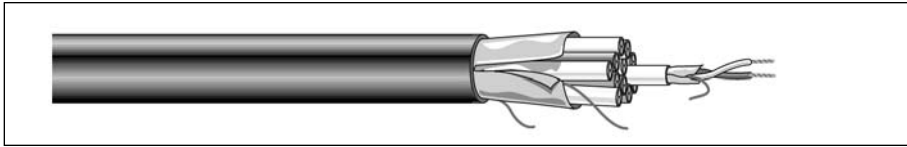

CATALOG NUMBER	CONDUCTOR	INSULATION & O.D.	SHIELD (COV.)	JACKET & O.D.	WT. #/m	IMPED. OHMS	CAPAC. pF/ft.
740601	1/PR 24 AWG Stranded 7/32 Tinned Copper	HD-Cellular PE 0.066" Nom.	Individual Foil w/ 24 AWG Drain Overall Foil w/ 18 AWG Drain	FR-PVC Matte Finish 0.176" Nom.	13.5	110	12.5
740604	4/PR 24 AWG Stranded 7/32 Tinned Copper	HD-Cellular PE 0.066" Nom.	Individual Foil w/ 24 AWG Drain Overall Foil w/ 18 AWG Drain	FR-PVC Matte Finish 0.525" Nom.	100	110	12.5
740608	8/PR 24 AWG Stranded 7/32 Tinned Copper	HD-Cellular PE 0.066" Nom.	Individual Foil w/ 24 AWG Drain Overall Foil w/ 18 AWG Drain	FR-PVC Matte Finish 0.700" Nom.	183	110	12.5
740612	12/PR 24 AWG Stranded 7/32 Tinned Copper	HD-Cellular PE 0.066" Nom.	Individual Foil w/ 24 AWG Drain Overall Foil w/ 18 AWG Drain	FR-PVC Matte Finish 0.850" Nom.	250	110	12.5
740616	16/PR 24 AWG Stranded 7/32 Tinned Copper	HD-Cellular PE 0.066" Nom.	Individual Foil w/ 24 AWG Drain Overall Foil w/ 18 AWG Drain	FR-PVC Matte Finish 1.000" Nom.	370	110	12.5
740620	20/PR 24 AWG Stranded 7/32 Tinned Copper	HD-Cellular PE 0.066" Nom.	Individual Foil w/ 24 AWG Drain Overall Foil w/ 18 AWG Drain	FR-PVC Matte Finish 1.100" Nom.	425	110	12.5

NOTE: General Cable manufactures the above cables in a wide range of alternate AWG sizes, pair counts and jacket colors. Please consult Customer Service for details.

Product Construction:

Conductor:

- 24 AWG stranded tinned copper
- Twisted pairs

Insulation:

- High-density foamed polyethylene

Shield:

- Individually shielded pairs with 24 AWG drain wire
- Overall foil shield with 18 AWG drain wire

Jacket:

- PVC, matte black
- High-flex, flame-retardant

Applications:

- Digital audio
- Interconnection and audio components for console board equipment used in recording studios, radio and television stations, and post-production facilities
- Sound system installations

Features:

- High impedance, 78% velocity and low capacitance providing error-free transmissions over extended distances
- PVC jacketing compound for ultimate cosmetics, durability and flexibility
- Jacketed pairs can be split out of overall jacket for any length without use of heat-shrink tubing
- Individual pair jackets are color-coded and number-printed for easy identification

Compliances:

- NEC Article 725 Type CL2
- NEC Article 800 Type CM
- Meets/exceeds requirements of Audio Engineering Society (AES) and European Broadcast Union (EBU)

Packaging and Jacket Colors:

- Please consult Customer Service for packaging and color options

Analog Audio Snake Cable

70 Ohm Low Capacitance Multi-Pair Individually Shielded & Jacketed, NEC Type CM/CL2

Product Construction:

Conductor:

- 24 AWG stranded tinned copper
- Twisted pairs

Insulation:

- Polyolefin

Shield:

- Individually shielded pairs with 24 AWG drain wire
- Overall foil shield 24 AWG drain wire

Jacket:

- PVC, matte black
- High-flex, flame-retardant

Applications:

- Analog audio
- Line level microphone
- Interconnection and audio components for console board equipment used in recording studios, radio and television stations, and post-production facilities
- Sound system installations

Features:

- PVC jacketing compound for superior cosmetics, durability and flexibility
- Individually shielded and jacketed pairs with an overall shield
- Individual pair jackets alpha-numerically numbered for easy identification

Compliances:

- NEC Article 725 Type CL2
- NEC Article 800 Type CM

Packaging and Jacket Colors:

- Please consult Customer Service for packaging and color options

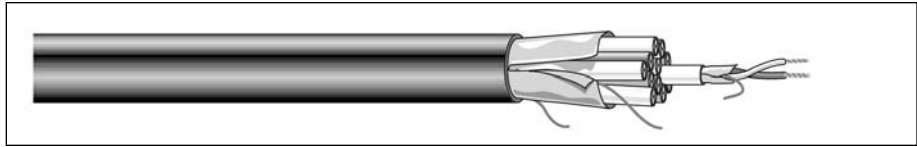

CATALOG NUMBER	CONDUCTOR	INSULATION & O.D.	SHIELD (COV.)	JACKET & O.D.	WT. #/m	IMPED. OHMS	CAPAC. pF/ft
STRANDED CONDUCTORS							
740501	1/PR 24 AWG Stranded 7/32 Tinned Copper	Polyolefin 0.024" Nom.	Overall Foil w/ 24 AWG Drain Overall Foil w/ 18 AWG Drain	FR-PVC Matte Finish 0.137" Nom.	11	65	24
740504	4/PR 24 AWG Stranded 7/32 Tinned Copper	Polyolefin 0.024" Nom.	Overall Foil w/ 24 AWG Drain Overall Foil w/ 18 AWG Drain	FR-PVC Matte Finish 0.385" Nom.	64	65	24
740508	8/PR 24 AWG Stranded 7/32 Tinned Copper	Polyolefin 0.024" Nom.	Overall Foil w/ 24 AWG Drain Overall Foil w/ 18 AWG Drain	FR-PVC Matte Finish 0.490" Nom.	107	65	24
740512	12/PR 24 AWG Stranded 7/32 Tinned Copper	Polyolefin 0.024" Nom.	Overall Foil w/ 24 AWG Drain Overall Foil w/ 18 AWG Drain	FR-PVC Matte Finish 0.610" Nom.	160	65	24
740516	16/PR 24 AWG Stranded 7/32 Tinned Copper	Polyolefin 0.024" Nom.	Overall Foil w/ 24 AWG Drain Overall Foil w/ 18 AWG Drain	FR-PVC Matte Finish 0.680" Nom.	205	65	24
740520	20/PR 24 AWG Stranded 7/32 Tinned Copper	Polyolefin 0.024" Nom.	Overall Foil w/ 24 AWG Drain Overall Foil w/ 18 AWG Drain	FR-PVC Matte Finish 0.700" Nom.	248	65	24
740528	28/PR 24 AWG Stranded 7/32 Tinned Copper	Polyolefin 0.024" Nom.	Overall Foil w/ 24 AWG Drain Overall Foil w/ 18 AWG Drain	FR-PVC Matte Finish 0.820" Nom.	340	65	24
740542	42/PR 24 AWG Stranded 7/32 Tinned Copper	Polyolefin 0.024" Nom.	Overall Foil w/ 24 AWG Drain Overall Foil w/ 18 AWG Drain	FR-PVC Matte Finish 1.050" Nom.	485	65	24
740552	52/PR 24 AWG Stranded 7/32 Tinned Copper	Polyolefin 0.024" Nom.	Overall Foil w/ 24 AWG Drain Overall Foil w/ 18 AWG Drain	FR-PVC Matte Finish 1.150" Nom.	595	65	24

NOTE: General Cable manufactures the above cables in a wide range of alternate AWG sizes, pair counts and jacket colors. Please consult Customer Service for details.

Analog Audio Snake Cable

70 Ohm Low Capacitance Multi-Pair Individually Shielded, NEC Type CM/CL2

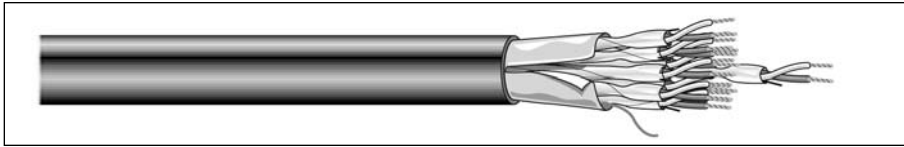

CATALOG NUMBER	CONDUCTOR	INSULATION & O.D.	SHIELD (COV.)	JACKET & O.D.	WT. #/m	IMPED. OHMS	CAPAC. pF/ft
740701	1/PR 24 AWG Stranded 7/32 Tinned Copper	Polyolefin 0.044" Nom.	Overall Foil w/ 24 AWG Drain Overall Foil w/ 18 AWG Drain	FR-PVC Matte Finish 0.137" Nom.	11	65	24
740704	4/PR 24 AWG Stranded 7/32 Tinned Copper	Polyolefin 0.044" Nom.	Overall Foil w/ 24 AWG Drain Overall Foil w/ 18 AWG Drain	FR-PVC Matte Finish 0.280" Nom.	39	65	24
740706	6/PR 24 AWG Stranded 7/32 Tinned Copper	Polyolefin 0.044" Nom.	Overall Foil w/ 24 AWG Drain Overall Foil w/ 18 AWG Drain	FR-PVC Matte Finish 0.330" Nom.	55	65	24
740708	8/PR 24 AWG Stranded 7/32 Tinned Copper	Polyolefin 0.044" Nom.	Overall Foil w/ 24 AWG Drain Overall Foil w/ 18 AWG Drain	FR-PVC Matte Finish 0.350" Nom.	69	65	24
740709	9/PR 24 AWG Stranded 7/32 Tinned Copper	Polyolefin 0.044" Nom.	Overall Foil w/ 24 AWG Drain Overall Foil w/ 18 AWG Drain	FR-PVC Matte Finish 0.380" Nom.	76	65	24
740712	12/PR 24 AWG Stranded 7/32 Tinned Copper	Polyolefin 0.044" Nom.	Overall Foil w/ 24 AWG Drain Overall Foil w/ 18 AWG Drain	FR-PVC Matte Finish 0.425" Nom.	96	65	24
740716	16/PR 24 AWG Stranded 7/32 Tinned Copper	Polyolefin 0.044" Nom.	Overall Foil w/ 24 AWG Drain Overall Foil w/ 18 AWG Drain	FR-PVC Matte Finish 0.490" Nom.	130	65	24
740720	20/PR 24 AWG Stranded 7/32 Tinned Copper	Polyolefin 0.044" Nom.	Overall Foil w/ 24 AWG Drain Overall Foil w/ 18 AWG Drain	FR-PVC Matte Finish 0.540" Nom.	158	65	24
740728	28/PR 24 AWG Stranded 7/32 Tinned Copper	Polyolefin 0.044" Nom.	Overall Foil w/ 24 AWG Drain Overall Foil w/ 18 AWG Drain	FR-PVC Matte Finish 0.655" Nom.	221	65	24
740742	42/PR 24 AWG Stranded 7/32 Tinned Copper	Polyolefin 0.044" Nom.	Overall Foil w/ 24 AWG Drain Overall Foil w/ 18 AWG Drain	FR-PVC Matte Finish 0.775" Nom.	327	65	24
740752	52/PR 24 AWG Stranded 7/32 Tinned Copper	Polyolefin 0.044" Nom.	Overall Foil w/ 24 AWG Drain Overall Foil w/ 18 AWG Drain	FR-PVC Matte Finish 0.845" Nom.	391	65	24

NOTE: General Cable manufactures the above cables in a wide range of alternate AWG sizes, pair counts and jacket colors. Please consult Customer Service for details.

Product Construction:

Conductor:

- 24 AWG stranded tinned copper
- Twisted pairs

Insulation:

- Polyolefin

Shield:

- Individually shielded pairs with 24 AWG drain wire
- Overall foil shield 24 AWG drain wire

Jacket:

- PVC, matte black
- High-flex, flame-retardant

Applications:

- Line level microphone
- Interconnection and audio components for console board equipment used in recording studios, radio and television stations, and post-production facilities
- Sound system installations

Features:

- PVC jacketing compound for superior cosmetics, durability and flexibility
- Individually shielded pairs are color-coded for easy identification

Compliances:

- NEC Article 725 Type CL2
- NEC Article 800 Type CM

Packaging and Jacket Colors:

- Please consult Customer Service for packaging and color options

Guitar/Instrument Cable

Product Construction:

Conductor:

- 20 or 24 AWG stranded bare copper

Insulation:

- Dual layer of semi-conductive PVC over polyethylene

Shield:

- 36 AWG bare copper braid or spiral

Jacket:

- High quality audio (HQA) PVC, matte black
- Superior flexibility

Applications:

- Guitars
- Basses
- Keyboards and other instruments to amplifiers, mixers and effects pedals
- All outdoor signal processing gear

Features:

- Low capacitance to provide excellent structural return loss characteristics
- Specially formulated vinyl sleeving reduces triboelectric charges which cause microphonic handling noise in high-gain amplification applications

Packaging and Jacket Colors:

- Please consult Customer Service for packaging and color options

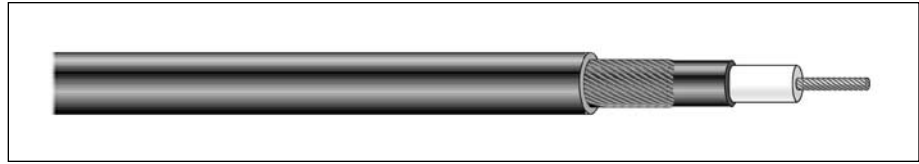

CATALOG NUMBER	CONDUCTOR	INSULATION & O.D.	SHIELD (COV.)	JACKET & O.D.	WT. #/m	IMPED. OHMS	CAPAC. pF/ft.
743601	1/C 20 AWG Stranded 41/36 Bare Copper	0.038" Poly 0.010" Semi Conductive Vinyl	36 AWG 95% Nom. Bare Copper Braid	"HQA" PVC 0.240 Nom. Black	34	47	33
743602	1/C 20 AWG Stranded 41/36 Bare Copper	0.038" Poly 0.010" Semi Conductive Vinyl	36 AWG 65% Nom. Bare Copper Spiral	"HQA" PVC 0.240 Nom. Black	34	47	33
743603	1/C 20 AWG Stranded 41/36 Bare Copper	0.038" Poly 0.010" Semi Conductive Vinyl	36 AWG 95% Nom. Bare Copper Braid	"HQA" PVC 0.240 Nom. Black	34	47	33
743604	1/C 20 AWG Stranded 22/34 Bare Copper	0.025" Poly 0.010" Semi Conductive Vinyl	36 AWG 65% Nom. Bare Copper Spiral	"HQA" PVC 0.235 Nom. Black	36	47	33
743605	1/C 24 AWG Stranded 7/32 Bare Copper	0.040" Poly 0.010" Semi Conductive Vinyl	36 AWG 95% Nom. Bare Copper Spiral	"HQA" PVC 0.235 Nom. Black	30	47	33

Ultra Flexible, Low Impedance 2-Conductor Microphone Cable

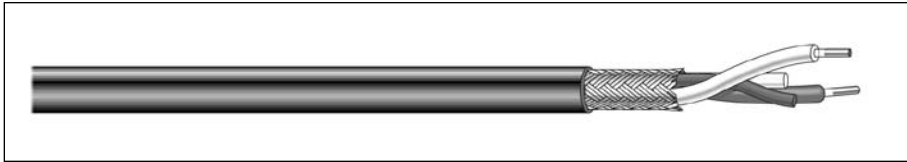

CATALOG NUMBER	CONDUCTOR	INSULATION & O.D.	SHIELD (COV.)	JACKET & O.D.	WT. #/m	IMPED. OHMS	CAPAC. pF/ft
743701	2/C 24 AWG Stranded 105/44 Bare Copper	PVC 0.045" Nom.	80% Nom. Bare Copper Braid	"HQA" PVC 0.176" Nom. Black	22	65	30
743704	2/C 24 AWG Stranded 41/40 Bare Copper	Polyethylene 0.050" Nom.	95% Tinned Copper Braid	"HQA" PVC 0.194" Nom. Black	23	80	20
743705	2/C 24 AWG Stranded 16/36 Bare Copper	Polyethylene 0.050" Nom.	95% Bare Copper Spiral	"HQA" PVC 0.225" Nom. Black	29	80	20
743706	2/C 22 AWG Stranded 26/36 Bare Copper	Polyethylene 0.062" Nom.	85% Bare Copper Braid	"HQA" PVC 0.232" Nom. Black	34	85	18
743707	2/C 20 AWG Stranded 41/36 Bare Copper	Polyethylene 0.074" Nom.	85% Bare Copper Braid	"HQA" PVC 0.262" Nom. Black	40	80	20

Product Construction:

Conductor:

- 20-24 AWG stranded bare copper
- Twisted pairs

Insulation:

- PVC or polyethylene

Shield:

- Braid or spiral, bare or tinned copper (choice of shielding configurations)

Jacket:

- High quality audio (HQA) PVC, matte black
- Superior flexibility

Applications:

- General-purpose audio applications
- Home entertainment
- Musical instruments

Features:

- Twisted conductor construction minimizes effects of EMI
- Precise application of filler maintains mechanical durability to resist annoying handling noise
- Braid shield guards against crosstalk and EMI while minimizing capacitive reactance, which causes hum and buzz
- High strand conductor plus HQA jacket results in ultimate flexibility

Packaging and Jacket Colors:

- Please consult Customer Service for packaging and color options

Multi-Conductor, Flexfoil® Shield

Product Construction:

Conductor:

- 24 AWG fully annealed stranded tinned copper per ASTM B-33

Insulation:

- Premium-grade, color-coded polypropylene
- Color code: See chart below

Shield:

- Conductive tape applied over the core
- 100% Flexfoil® aluminum/polyester, 25% overlap, minimum, foil facing in
- Stranded tinned copper drain wire

Jacket:

- PVC, black
- Temperature range: -20°C to +75°C

Applications:

- Electronic circuits where RF shielding is required
- Radio transmitters
- Sound systems
- Recording studios
- Suggested voltage rating: 300 volts

Features:

- Excellent shielding to reduce noise

Compliances:

- RoHS Compliant Directive 2002/95/EC

Packaging:

- Please contact Customer Service for packaging and color options

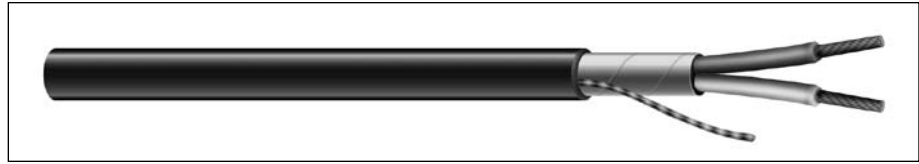

CATALOG NUMBER	NO. OF COND.	AWG SIZE	COND. STRAND	NOM. INSULATION THICKNESS		NOM. JACKET THICKNESS		NOMINAL O.D.		NOM. CAP.*	
				INCHES	mm	INCHES	mm	INCHES	mm	A	B
C1228A	2	24	19/36	0.008	0.20	0.022	0.56	0.135	3.43	27.0	48.5

*A – Capacitance between conductors

*B – Capacitance between one conductor and other conductors connected to shield

Color Code Chart

NO. OF COND.	COLOR
1	Black
2	Red

Multi-Conductor, Rubber, Braid Shield Microphone Cable

High and Low Impedance

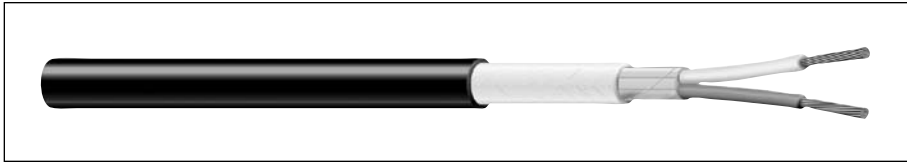

CATALOG NUMBER	NO. OF COND.	AWG SIZE	COND. STRAND	NOM. INSULATION THICKNESS		NOM. JACKET THICKNESS		NOMINAL O.D.		NOM. CAP.* pF/ft
				INCHES	mm	INCHES	mm	INCHES	mm	
C1300	1	20	26/34	0.042	1.07	0.035	0.89	0.230	5.84	42.0
C1301	1	18	41/34	0.040	1.02	0.035	0.89	0.240	6.10	46.0
C1302	2	20	26/34	0.020	0.51	0.035	0.89	0.270	6.86	50.0

*Capacitance between one conductor and other conductors connected to shield

Color Code Chart

NO. OF COND.	COLOR
1	White
2	Black

Product Construction:

Conductor:

- 18 and 20 AWG fully annealed stranded tinned copper per ASTM B-33

Insulation:

- Premium-grade, color-coded rubber insulation
- Color code: See chart below

Shield:

- Clear Mylar® wrap
- 80% tinned copper braid
- Cotton wrap

Jacket:

- Rubber, black
- Temperature range: -20°C to +60°C

Applications:

C1300, C1301:

- High-impedance microphones
- Broadcast and studio use
- Communication and audio system
- Shielded power supplies
- Suggested voltage rating: 300 volts

C1302:

- Low-impedance microphones
- Studio use
- Control circuits
- Video and audio interconnecting cables
- Shielded power supplies
- Suggested voltage rating: 300 volts

Features:

- Precision engineered to transmit clear, noise-free signals
- Minimizes electrical "hum"
- Braid shield provides extra flexibility

Compliances:

- RoHS Compliant Directive 2002/95/EC

Packaging:

- Please contact Customer Service for packaging and color options

Multi-Conductor, Spiral Shield

Product Construction:

Conductor:

- 24 AWG annealed stranded bare copper per ASTM B-3

Insulation:

- Premium-grade, color-coded PVC
- Color code: See chart below

Shield:

- 85% spiral-tinned copper

Jacket:

- PVC, black
- Temperature range: -20°C to +90°C

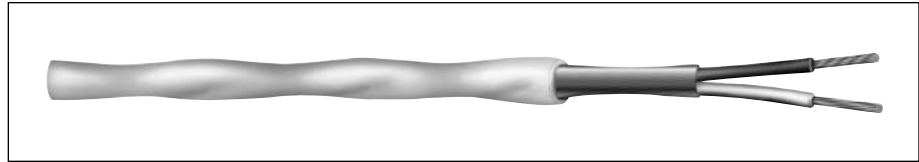

CATALOG NUMBER	NO. OF COND.	AWG SIZE	COND. STRAND	NOM. INSULATION THICKNESS		NOM. JACKET THICKNESS		NOMINAL O.D.		NOM. CAP.*	
				INCHES	mm	INCHES	mm	INCHES	mm	A	B
C1226A	2	24	105/44	0.012	0.30	0.030	0.76	0.176	4.47	43.0	77.0

*A – Capacitance between conductors

*B – Capacitance between one conductor and other conductors connected to shield

Applications:

- Electronic circuits where RF shielding is required
- Radio transmitters
- Sound systems
- Recording studios
- Suggested voltage rating: 300 volts

Color Code Chart

NO. OF COND.	COLOR
1	White
2	Green

Features:

- Spiral shield provides extra flexibility
- Excellent shielding to reduce noise

Compliances:

- RoHS Compliant Directive 2002/95/EC

Packaging:

- Please contact Customer Service for packaging and color options

Multi-Conductor, Braid Shield

Low Impedance

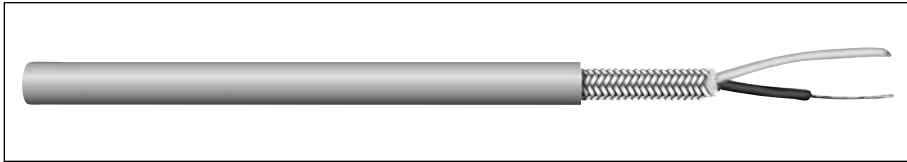

CATALOG NUMBER	TYPE	NO. OF COND.	AWG SIZE	COND. STRAND	NOM. INSULATION THICKNESS		NOM. JACKET THICKNESS		NOMINAL O.D.		NOM. CAP.* pF/ft
					INCHES	mm	INCHES	mm	INCHES	mm	
C1322A	Low Imped.	2	22	16/34	0.025	0.64	0.025	0.64	0.239	6.07	31.0

*Capacitance between one conductor and other conductors connected to shield

Color Code Chart

NO. OF COND.	COLOR
1	White
2	Black

Product Construction:

Conductor:

- 22 AWG fully annealed stranded tinned copper per ASTM B-33

Insulation:

- Premium-grade, color-coded polyethylene
- Fillers where required
- Color code: See chart below

Shield:

- 80% tinned copper braid

Jacket:

- PVC, gray
- Temperature range: -20°C to +75°C

Applications:

- Low-impedance microphones
- Suggested voltage rating: 1000 volts

Features:

- Flexlife® jacket provides extreme flexibility
- High abrasion resistance
- Outstanding appearance

Compliances:

- RoHS Compliant Directive 2002/95/EC

Packaging:

- Please contact Customer Service for packaging and color options

Microphone Cable, Multi-Conductor, Carolprene[®], Braid Shield High and Low Impedance

Product Construction:

Conductor:

- 18 and 16 AWG fully annealed stranded tinned copper per ASTM B-33

Insulation:

- Premium-grade, color-coded rubber
- Color code: See chart below

Shield:

- Clear Mylar[®] wrap
- 80% braid tinned copper
- Cotton wrap

Jacket:

- Carolprene[®], black
- Temperature range: -20°C to +60°C

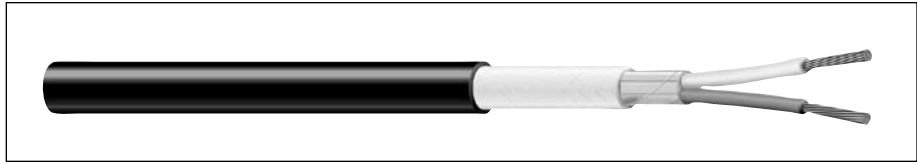

CATALOG NUMBER	NO. OF COND.	AWG SIZE	COND. STRAND	NOM. INSULATION THICKNESS		NOM. JACKET THICKNESS		NOMINAL O.D.		NOM. CAP.* pF/ft
				INCHES	mm	INCHES	mm	INCHES	mm	
C1201	1	18	41/34	0.040	1.02	0.035	0.89	0.240	6.10	46.0
C1202	2	18	41/34	0.020	0.51	0.035	0.89	0.295	7.49	61.0
C1602	2	16	65/34	0.025	0.64	0.035	0.89	0.335	8.51	55.0

*Capacitance between one conductor and other conductors connected to shield

Applications:

C1201:

- High-impedance microphones
- Broadcast and studio use
- Communication and audio systems
- Suggested voltage rating: 300 volts

C1202, C1602:

- Low-impedance microphones
- Studio use
- Control circuits
- Video and interconnecting cables
- Shielded power supplies
- Suggested voltage rating: 300 volts

Features:

- Precision engineered to transmit clear, noise-free signals
- Minimizes electrical "hum"
- Resistant to oil, acid, sunlight, abrasion and aging
- Excellent noise rejection

Compliances:

- RoHS Compliant Directive 2002/95/EC

Packaging:

- Please contact Customer Service for packaging and color options

Color Code Chart

NO. OF COND.	COLOR
1	White
2	Black

SMPTE-311 Hybrid Fiber Optic/Copper Camera Cable

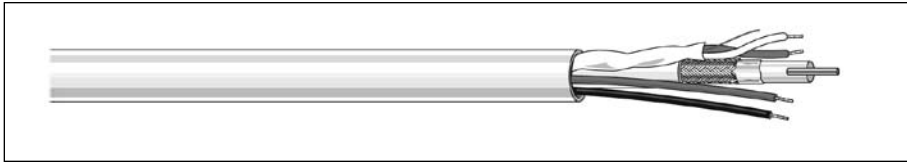

CATALOG NUMBER	AUXILIARY CONDUCTOR	SIGNAL COND.	OPTICAL FIBER	STRENGTH MEMBER	SHIELD	JACKET
742608	(4) 20 AWG 26/34 Strand Tinned Cu High-density Polyethylene Insul. O.D. 0.060"	(2) 25 AWG 7/33 Strand Tinned Cu High-density Polyethylene Insul. O.D. 0.045"	(2) 9.5 Micron Single-Mode	14 AWG 19/27 Strand Galvanized Steel	95% Braid Tinned CU	Flexible PVC (HQA) Black 0.362" O.D. 9.20 mm
574608	(4) 20 AWG 26/34 Strand Tinned Cu High-density Polyethylene Insul. O.D. 0.060"	(2) 25 AWG 7/33 Strand Tinned Cu High-density Polyethylene Insul. O.D. 0.045"	(2) 9.5 Micron Single-Mode	14 AWG 19/27 Strand Galvanized Steel	95% Braid Tinned CU	Ruggedized Outdoor TPR Black 0.362" O.D. 9.20 mm

NOTE: General Cable manufactures the above cables in a wide range of alternate AWG sizes, pair counts and jacket colors. Please consult Customer Service for details.

Cable Characteristics

ELEMENT NUMBER	(1) AUXILIARY CONDUCTORS	(2) SIGNAL CONDUCTORS	(3) SINGLEMODE FIBER OPTIC	
CONDUCTOR DCR	35.29Ω/Km max @20°C	97.5Ω/Km max @20°C	<i>Mode Field Data</i>	9.5+/-1 Micron
DC LOOP RESISTANCE	43Ω/Km max @20°C	184Ω/Km max @20°C	<i>Cladding Data</i>	125+/-1 Micron
INSULATION RESISTANCE	10,000Ω/Km max @20°C	10,000Ω/Km max @20°C	<i>Buffer Material</i>	Thermoplastic
DIELECTRIC STRENGTH	1750V RMS@20°C, 60Hz for 1 min	1750V RMS@20°C, 60Hz for 1 min		
VOLTAGE RATING	300V Max	300V Max		
COLOR	C1, C3-Black C2, C4-White	C1-Red C2-Gray		C1-Blue C2-Yellow

TYPICAL CROSS SECTION

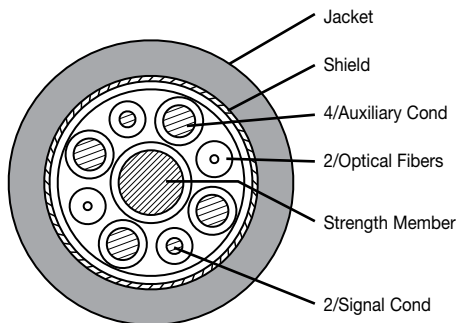

Product Construction:

Conductor:

- Element #1: 4 auxiliary conductors (used as two)
Size: 20 AWG; stranded tinned annealed copper
Insulation: High-density polyethylene O.D.: 0.060" nom. (1.53mm)
- Element #2: 2 single conductors
Size: 24 AWG; stranded tinned annealed copper
Insulation: High-density polyethylene: 0.045" nom. (1.12mm)
- Element #3: Singlemode fiber optic
- Element #4: Strength member in core
Size: 16 AWG; stranded insulated galvanized steel cable
Color: White
O.D.: 0.083" nom. (2.1mm)

Fillers:

- Fibrillated polypropylene as needed for roundness

Binder:

- Paper tape with 25% overlap

Braid Shield:

- Flexibly designed braid shield with 85% nom. coverage

Jacket:

- Flexible PVC (HQA)
- Temperature range: -40°C to +75°C
- Humidity 0 to 95%
- TPR ruggedized outdoor version

Jacket Marking:

- HELIX/HITEMP P/N XXXXXX* SINGLE-MODE FIBER OPTIC/ELECTRICAL HD CAMERA CABLE (RU) AWM STYLE 21059 80C 300V VW-1

Cable Weight:

- 87.6 lbs/Mft nom. (130.8Kg/KM)

Performance:

- Meets/exceeds SMPTE-311 M-1998

Connector:

- LEMO connector (call LEMO for more information at 800.444.5366)
- SMPTE standard 304 video connector

Compliances:

- UL Subject 758
- AWM Style 21059

Packaging:

- Please consult Customer Service for packaging and color options

*XXXXXX - indicates part number



Electronic News Gathering/Field Production Camera Cable

Product Construction:

Applications:

- Ideal for TV broadcast and CCTV applications
- Suited for controlling, powering and transmitting audio and video signals for TV cameras
- Additional uses include remote control, monitor and cue line systems

Features:

- Provides excellent circuit isolation
- Superior durability characteristics in a variety of environmental conditions

Packaging and Jacket Colors:

- Please contact Customer Service for packaging and color options

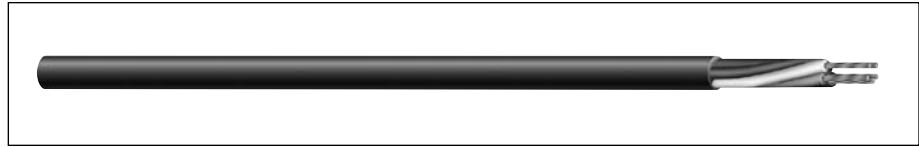

CATALOG NUMBER	COAXIAL COMPONENT	SIGNAL PAIR	POWER PAIR	JACKET
742605	1/C 25 AWG Stranded 7/33 Bare Copper High-density Polyethylene Insulation 90% Bare Copper Braid PVC Jacket O.D. 0.175" Nom.	1/PR 24 AWG Stranded 19/36 Bare Copper Polyethylene Insulation + Foil 24 AWG Drain O.D. 0.140" Nom.	1/PR 22 AWG Stranded 26/36 Bare Copper PVC Insulation O.D. 0.100" Nom.	Matte Black "HQA" PVC O.D. .495" Nom.

NOTE: General Cable manufactures the above cables in a wide range of alternate AWG sizes, pair counts and jacket colors. Please consult Customer Service for details.

Specialty Cable

9

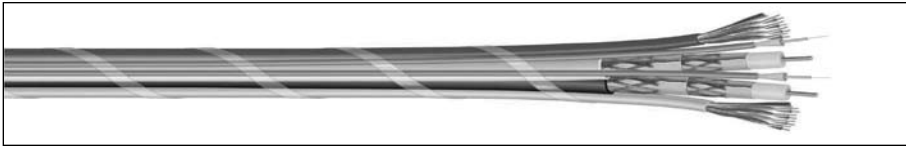

General Cable has a variety of wire and cable available for special applications. This section includes an array of products from our Fluorobus flat bus ground/power distribution cable to high-speed serial interface cable, known as Fire Wire, and computer cables.

For more information on these cables or for other special applications, please contact your General Cable sales representative.

Index	Page
Armored Electronics Products Guide	179-180
Wind Energy	181
Fluorobus Cable	182
Fire Wire	183
Computer Cable	184
Composite Data and Control Cable	185

**CAROL
BRAND****ELECTRONICS
WIRE & CABLE**

■ Armored Electronics Products

General Cable now offers the capability to armor virtually any Carol® Brand Electronics cable.

This rugged exterior and protection allows for the installation of almost any Electronics cable in markets with the toughest and most rigorous building code requirements. Cables placed in armor are not only acceptable for use in Riser applications, but according to NEC Article 300.22(B), these cables are acceptable in Plenum applications as well.

The process to convert a standard Carol Brand Electronics cable to an armored cable is simple and is explained on the back of this bulletin. All you really need to know is: 1) which cable you want to armor, 2) whether you want steel or aluminum interlock armor, and 3) what put-up lengths you would like to receive product on.

General Cable continues to expand its Carol Brand Electronics product offering to allow our customers to participate in more diversified markets. You can always *Demand Better...Expect More™* with General Cable Carol Brand Electronics cables. We manufacture over 1,300 standard electronic cables that we ship direct from stock, and we have the technical staff and design expertise to meet any customer cable requirement.



Special Application Cable

Hook-Up Wire

Plenum Cable

Coaxial Cable

Microphone Cable

Computer Cable

General Purpose Cable

Multi-Conductor Communication
& Control Cable

Multi-Paired Communication
& Control Cable

Fire Alarm Cable

Sound & Security Cable

 **General Cable****CAROL
BRAND**

HOW TO ARMOR YOUR ELECTRONICS

Step 1 - Find a Carol Brand part # in the catalog that you want to armor.

Step 2 - Build your Carol Brand Armored part #

Carol® Brand Communication & Control Cable, Multi-Conductor, Unshielded

CATALOG NUMBER	NO. OF COND.	AWG SIZE	COND. STRAND.	NOM. INSULATION THICKNESS		NOMINAL JACKET THICKNESS		NOMINAL O.D.		NOM. C-C CAP. pF/FT
				INCHES	mm	INCHES	mm	INCHES	mm	
C2409A	2	14	19/0147	0.030	0.81	0.032	0.81	0.260	6.81	30.5

- ① Pick the root part # you want to armor.
- ② Pick the put-up length that you want.
- ③ Pick the color of jacket for the wire.
- ④ Pick the type of armor you want.



Armored Part # looks like: C2409A.41.02A

Description is now: 14 AWG / 2 Conductor, Unshielded, White Jacket Communication Cable in Aluminum Armor on a 1000' Reel.

Armor Codes & Charts

Armor Sizing Chart				
CABLE DIAMETER	ARMOR STRIP WIDTH	CLEARANCE (IN)	ARMOR O.D. (IN)	ARMOR WEIGHT (LBS/mFT)
0.190	3/8"	0.060	0.350	29.000
0.250	3/8"	0.100	0.450	38.600
0.300	3/8"	0.100	0.500	43.400
0.350	3/8"	0.100	0.550	48.300
0.400	3/8"	0.100	0.600	53.100
0.450	3/8"	0.100	0.650	57.900
0.500	3/8"	0.100	0.700	62.700
0.550	3/8"	0.100	0.750	67.600
0.600	3/8"	0.100	0.800	72.400
0.650	3/8"	0.100	0.850	77.200
0.700	1/2"	0.100	0.900	109.400
0.750	1/2"	0.100	0.950	115.800
0.800	1/2"	0.100	1.000	122.300

Wire Jacket Color	
CODE	COLOR
01	BLACK
02	WHITE
03	RED
04	ORANGE
05	YELLOW
06	GREEN
07	DARK BLUE
08	BROWN
09	MAROON
10	GRAY
11	ANTIQUE GOLD
12	IVORY
13	PINK

Armor Codes	
TYPE	CODE
Aluminum	A
Steel	S

Put-Up Codes	
SIZE	CODE
250'	35
500'	38
1000'	41

NOTE 1: Consult factory for additional put-up lengths
NOTE 2: Product provided on reels

NOTE: Additional colors available

Products in the Electronics Catalog that can be armored:

- Section 2 - Communication & Control Cable, Multi-Conductor
- Section 3 - Communication & Control Cable, Multi-Paired
- Section 4 - Computer Cable
- Section 5 - Coaxial Cable

- Section 6 - Fire Alarm / Life Safety Cable
- Section 7 - Sound, Alarm, & Security
- Section 8 - Audio / Home Entertainment Cable

Delivering the renewable power of **Wind Energy**

Wind knows no boundaries,
and neither does General Cable.

Answering the Call

Wind. It's plentiful, renewable, and clean. That's why wind power has increased more than fivefold since the beginning of the 21st century, taking center stage as the fastest growing alternative energy source in the global arena. With increased energy demand and mounting political pressure, alternative energy mandates are cropping up all over the world, with many countries calling for significant growth in wind generation capacity over the next decade. General Cable has the experience, the innovation, and the global presence to answer that call.

Since the first modern wind turbine was developed in the 1980s, General Cable has been committed to delivering the renewable power of wind energy through ground-breaking wire and cable technologies. General Cable has developed cables that are flexible yet tough enough to withstand the continuous motion of today's wind turbines. Our commitment to providing the highest quality and reliable products lowers cost and extends turbine operating life by reducing failures and maintaining continuous power.

Knowing No Boundaries

Wind knows no boundaries, and neither does General Cable. From Brazil, Mexico, and the U.S. to Germany, Spain, China, India, and Australia, initiatives are in place to increase wind power, with targets to support a significantly higher percentage of energy needs.

With a solid presence in North America, South America, Europe, Asia, Africa, the Middle East, and Oceania, General Cable has the geographical presence to focus on region-specific wind power needs and to meet domestic and global specifications. At the same time, General Cable's

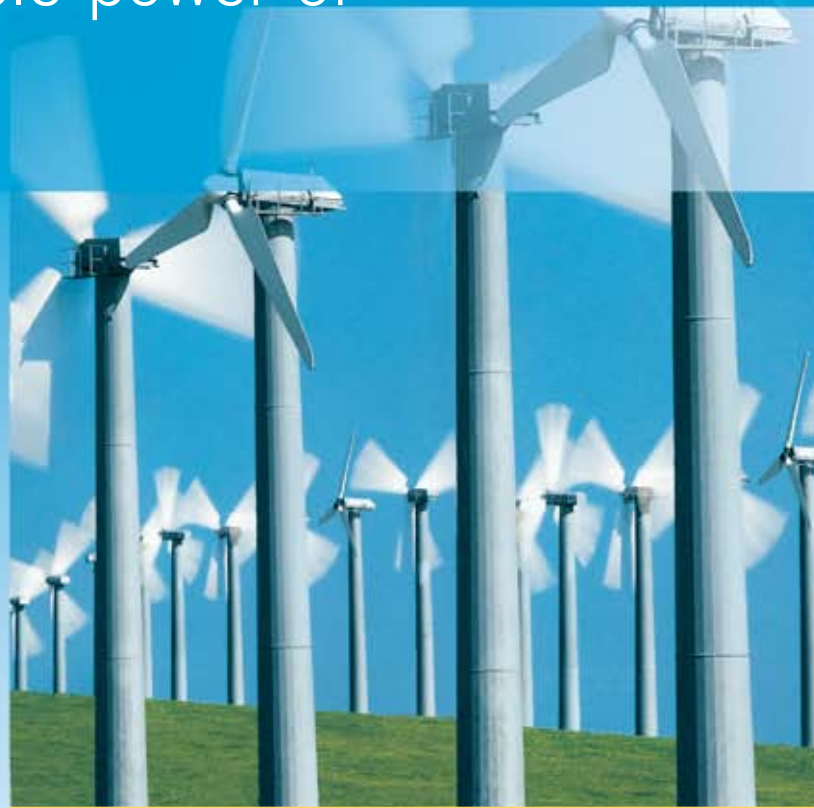

One Company approach means we have a keen ability to unite and leverage our broad knowledge and shared resources to bring innovative solutions to the entire world.

Setting the Benchmark

Whether it is terrestrial wind farms requiring direct buried cables or offshore wind farms requiring high-performance submarine cables, General Cable has one of the most diverse and expansive ranges of products to meet virtually every application in the wind power industry. From fiber optic and bare overhead conductors to underground URD and low-voltage power, control, and electronic cables, General Cable offers the full array of cables needed for wind turbines to generate, distribute, and transmit energy.

As the benchmark in the wire and cable industry, renowned for our engineering and material development capabilities, General Cable is positioned to rapidly respond to the needs of the evolving wind farm market with next-generation cabling systems.

Call us today at **888.593.3355** for additional information.

Fluorobus Cable

Flat Bus Ground / Power Distribution Cable

CATALOG NUMBER	CONDUCTOR	INSULATION	FINISHED DIMENSIONS	DCR	POWER RATING
SP00C0011010	Flat Solid BC 0.010" x 0.987"	Tetzel® (ETFE)	0.028 x 1.022	0.82 Ohms per 1000 ft. @ 25°C	32 Amps Nom. 100 Amps Max.
SP00C0012010	Flat Solid BC 0.020" x 0.987"	Tetzel® (ETFE)	0.037 x 1.022	0.41 Ohms per 1000 ft. @ 25°C	64 Amps Nom. 100 Amps Max.

Information is subject to change without notice.

Applications:

- Ideally suited for low-voltage primary and secondary power distribution in electronic and data processing equipment. High-speed, solid-state circuits require relatively high currents with low voltage. For this reason, it is essential that DC power distribution lines have low inductance, low resistance and high capacitance. More important, tightly bundled or laminated flat cable source-and-return circuits deliver lower impedance and higher capacitance by one to two orders of magnitude, compared to round wire circuits with equal resistance.
- This system can serve as a low-cost flexible alternative to laminated bus bars. The Fluorobus low-profile routing capability is a useful packaging feature, and its large surface area (relative to round wire conductor of equal resistance) provides improved heat dissipation, minimizes voltage drop and results in a higher current rating.
- This flat conductor circuit delivers superior EMI/RFI performance, both as a source and as a receiver.

Features	Benefits
Low Profile:	Conserves space
Flexible:	Ease of routing
Large Surface Area:	Improved heat dissipation minimizes voltage drop High current rating

Temperature Rating:

- -50°C to +150°C

Voltage Rating:

- 300 volts and 600 volts (AWM) available (consult Customer Service)

Dielectric Constant:

- 2.6

Dielectric Strength:

- 900 VRMS

Packaging and Color:

- Please consult Customer Service for packaging and color options

Fire Wire*

IEEE 1394 High-Speed Serial Interface

Applications:

- Transport digital data for computers and for professional and consumer electronic products
- Personal computers
- Audio/image/video products
- Printers/scanners
- Disc arrays
- Digital video cameras/displays/recorders

Compliances:

- UL: AWM 20276
- 80°C 30V VW-1
- CSA: PCC FT1

Packaging and Jacket Colors:

- Please consult Customer Service for packaging and color options

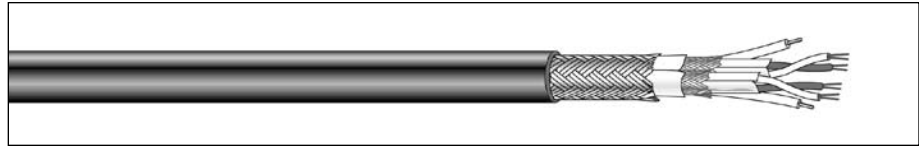

CATALOG NUMBER

Z028C0061110

SIGNAL PAIRS	POWER CONDUCTOR	OVERALL SHIELDING	OVERALL JACKET	SIGNAL PR. IMPED.	SIGNAL PR. CAPAC.	NOM. MHZ	ATTENUATION	
							DB	100'
2/C #22 7/36 TC Foam Poly Insulation Individual Foil & Braid No. 1: Red, Green No. 2: Blue, Orange	2/C #22 7/36 TC Polyolefin Insulation Black, White	Aluminum/ Mylar® (Foil Out) + 95% Braid	Flexible PVC	110 Ohms	12.5 pF/ft	1000.0	37	55

* Apple Computer trademark

Computer Cable

Mainframes, Data Transfer, Tape Drives, File Servers, Disc Drives, Workstations, Disc Arrays, Personal Computers, etc.

PART NUMBER	APPLICATION	DESCRIPTION
EO28P0501510	HIPPI	50 Pair, 28 AWG, 105 Ohm
EO24C0045510	Fiber Channel	2 Pair "Quad", 24 AWG, 150 Ohm
EO26C0045510	Fiber Channel	2 Pair "Quad", 26 AWG, 150 Ohm
EO28C0045510	Fiber Channel	2 Pair "Quad", 28 AWG, 150 Ohm
EO30C0045510	Fiber Channel	2 Pair "Quad", 30 AWG, 150 Ohm
EO28P0181510	IEEE-1284	18 Pair, 28 AWG, O/A Foil + Braid

Test & Measurement, Data Transfer, Electronic Publishing, Video Conferencing, Sound Synthesizers, PC Workstations, Multi-Media, Consumer Electronics, Cable TV, Digital Cameras/Camcorders, etc.

PART NUMBER	APPLICATION	DESCRIPTION
ZO28C0066110	IEEE-1394 (Fire Wire)	2 Pair, 28 AWG, 2/C 22 AWG

ISDN, CD-ROM Drives, Modems, Scanners, Printers, Audio I/O Devices, Keyboards, Telephone ISDN, etc.

PART NUMBER	APPLICATION	DESCRIPTION
ZO28C0042010	Universal Serial Bus	1 Pair, 28 AWG, 2/C 20 AWG
ZO28C0042210	Universal Serial Bus	1 Pair, 28 AWG, 2/C 22 AWG
ZO28C0042410	Universal Serial Bus	1 Pair, 28 AWG, 2/C 24 AWG
ZO28C0042610	Universal Serial Bus	1 Pair, 28 AWG, 2/C 26 AWG
ZO28C0042810	Universal Serial Bus	1 Pair, 28 AWG, 2/C 28 AWG

Video Monitors, CRTs, Workstations

PART NUMBER	APPLICATION	DESCRIPTION
ZO28C0101120	Monitor 10/C	3/Coax 28 AWG, 7/C 28 AWG

Applications:

- General Cable manufactures a diverse array of multiconductor cables for computers and the interconnection of their peripherals. Today's need for speed and signal capacity demands the most in cable materials and construction. Our state-of-the-art manufacturing allows us to control impedance, minimize signal skew and provide the proper shielding for applications from USB and Fire Wire right up through the latest Fiber Channel protocols. Whether your applications require parallel or serial signal transmission, General Cable has the technology to fill your needs.

Packaging and Jacket Colors:

- Please consult Customer Service for packaging and color options

Composite Data and Control Cable

NEC Type CMP (UL) c(UL)

Product Construction:

Conductor:

- 22 AWG and 18 AWG fully annealed stranded tinned copper per ASTM B-33

Insulation:

- 22 AWG - foam FEP
- 18 AWG - plenum PVC
- Color code: See chart below

Pair Shield (22 AWG):

- 100% Flexfoil® aluminum/polyester foil with 25% overlap, minimum
- Stranded tinned copper drain wire

Jacket:

- Plenum PVC, natural or as requested
- Temperature range: -20°C to +75°C

Applications:

- Multimedia systems
- Data and control circuits
- Suggested voltage rating: 300 volts

Compliances:

- NEC Article 800
- Designed to meet NFPA 262 and CSA FT-6 Steiner Tunnel Fire Tests for Plenum Applications

Features:

- Fire-retardant, low-smoke jacket

Packaging:

- Please contact Customer Service for packaging and color options

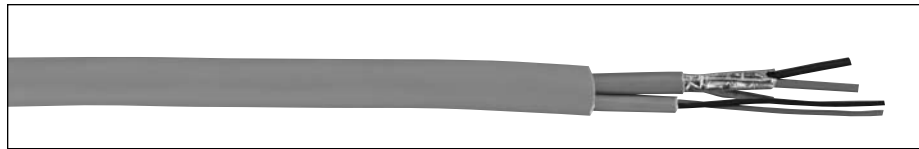

CATALOG NUMBER	NO. OF PAIRS	AWG SIZE	COND. STRAND	NOM. INSULATION THICKNESS		NOM. JACKET THICKNESS		NOMINAL O.D.		NOMINAL CAP. * pF/ft	
				INCHES	mm	INCHES	mm	INCHES	mm	A	B
22 AWG SHIELDED PAIR AND 18 AWG UNSHIELDED PAIR WITH OVERALL JACKET											
C8125	1 each	(22	7/30 TC	0.020	0.51)	0.015	0.381	0.195	4.95	13 (22)	35.0
		(18	16/30 TC	0.009	0.23)					30 (18)	

*A - Capacitance between conductors

*B - Capacitance between one conductor and other conductors connected to shield

Color Code Chart

AWG	COLOR
22	Blue & White
18	Black & Red

As technology becomes more complex, specifying wire and cable products to meet system performance demands becomes more time-consuming and complex.

Today's system designer must be aware not only of the general transmission line types, but also of the myriad of materials available to meet specific environmental or electrical performance criteria.

This technical section is presented to aid in the selection of materials and designs which will best suit the combination of hardware and transmission media.

For technical questions regarding specific transmission designs or applications, please contact General Cable's Engineering Department.

Index	Page
Insulation & Jacket Properties	187
Decimal Conversion Factors	188
Unit Conversion Factors	189
Temperature Conversion Chart	190
Conduit Capacity Chart	191
Coax Connector Cross Reference	192-199
AWG Conductor Chart	200
Cable Design Equations— Braid Shield	201
Coaxial Cable	202
Balanced Pair	203
Engineering Prefixes	204
Glossary	205-215
Abbreviations & Acronyms	216-218
Product Finders— Hook-Up Wire	219
Multi-Conductor Cable	220-222
Multi-Paired Cable	223-225
NEC/CEC Substitution Chart	226-227
Agency Symbols	228
Agency Approval Index	229
Put-Ups and Color Codes	230
Applications Index	231-233
Belden-to-General Cable Carol® Brand Cross Reference Index	234-239
Part Number Index	240-246
Notes	247

Insulation & Jacket Properties

TYPICAL PROPERTIES OF COMMON INSULATING MATERIALS

PARAMETER	PVC	PE	PP	XLPE	NYLON	FEP	TFE	BUTYL RUBBER	SILICONE RUBBER	TPR
Specific Gravity	1.37	0.92	0.89	0.93-1.18	1.09	2.16	2.17	1.40	1.24	1.16-1.20
Dielectric Constant (a) 60 Hz (b) 1000 Hz	6.0 5.0	2.26 2.26	2.6	3.0 3.0	4.6 4.5	2.15 2.15	2.1 2.1	4.1 4.0	3.3 3.1	2.8 2.8
Dielectric Strength, v/mil (a) 0.010" wall (b) 0.040" wall	1800 800	2100 1050	850 450	- 700	1000 470	2000 950	2000 950	700 500	600 400	625
Tensile Strength, PSI x 1000	1.5-3.8	1.4-2.4	2.9-4.5	1.8-2.5	8.8-11.9	2.3-3.1	2.0-6.0	0.5-1.5	0.6-1.2	2.3
Service Temp, Range, °C	-55/+105	-90/+90	-40/+105	-80/+75	-55/+105	-90/+200	-90/+260	-40/+90	-80/+200	-55/+90
Elongation, %	200-375	350-550	700	250-400	150-380	200-330	200-500	200-400	125-400	500
Water Absorption, % in 24 hr	<0.75	<0.02	<0.02	<0.01	2.5	<0.01	<0.01	<1.0	<1.0	<0.6
Flame Resistance	Self Extinguishing	Supports Flame	Supports Flame	Slow Flame	Self Extinguishing	Non-Flammable	Non-Flammable	Slow Burning	Slow (Non-Cond. Ash)	Flammable
Ozone Resistance	Excellent	Good	Excellent	Good	Good	Excellent	Excellent	Excellent	Excellent	Excellent
Flexibility	Good	Good	Good	Good-Fair	Good-Fair	Good	Good	Excellent	Excellent	Excellent
Abrasion Resistance	Good	Good	Fair	Excellent	Excellent	Excellent	Excellent	Poor	Poor	Good-Fair
Acid Resistance	Excellent	Excellent	Excellent	Excellent	Excellent	Poor	Excellent	Excellent	Good	Excellent
Base Resistance	Excellent	Excellent	Excellent	Excellent	Excellent	Excellent	Excellent	Good	Good	Excellent
Hydraulic Fluid Resistance	Good-Fair	Fair-Poor	Fair	Good-Fair	Good-Fair	Excellent	Excellent	Poor	Fair-Poor	Poor
Organic Solvent Resistance	Fair-Poor	Poor	Fair	Fair	Good-Fair	Excellent	Excellent	Good-Fair	Poor	Poor

NOTE: The above is representative of performance. For specific compound performance, consult Customer Service.

TYPICAL PROPERTIES OF COMMON JACKETING MATERIALS

PARAMETER	PVC	PE	NYLON	FEP	TFE	SILICONE RUBBER	NEOPRENE	POLY-URETHANE	TPR
Specific Gravity	1.37	0.92	1.09	2.16	2.17	1.24	1.52	1.3	1.16-1.20
Tensile Strength, PSI x 1000	1.5-3.8	1.4-2.4	8.8-11.9	2.3-3.1	2.0-6.0	0.6-1.2	2.5-4.0	>3.5	2.3
Elongation, %	200-375	350-550	150-380	200-330	200-500	125-400	300-500	540-700	500
Service Temp, Range, °C	-55/+105	-80/+75	-55/+105	-90/+200	-90/+200	-80/+200	-65/+90	-65/+75	-55/+90
Ozone Resistance	Excellent	Good	Good	Excellent	Excellent	Excellent	Excellent	Good	Excellent
Weatherability	Good-Fair	Excellent-Good	Fair-Poor	Excellent	Excellent	Excellent	Good	Good	Excellent
Flame Resistance	Self Extinguishing	Supports Flame	Flammable	Non-Flammable	Non-Flammable	Slow-Burn (Non-Cond. Ash)	Self Extinguishing	Slow Burn	Flammable
Flexibility	Good	Good	Good-Fair	Good	Good	Excellent	Excellent	Excellent	Excellent
Abrasion Resistance	Good	Good	Excellent	Excellent	Excellent	Poor	Excellent	Excellent	Good-Fair
Acid Resistance	Excellent	Excellent	Poor	Excellent	Excellent	Poor	Good	Fair	Excellent
Base Resistance	Excellent	Excellent	Excellent	Excellent	Excellent	Good	Good	Fair	Excellent
Hydraulic Fluid Resistance	Good-Fair	Fair-Poor	Good-Fair	Excellent	Excellent	Fair-Poor	Good	Poor	Good
Organic Solvent Resistance	Fair-Poor	Poor	Good-Fair	Excellent	Excellent	Poor	Good	Poor	Poor
Resistance to Tearing	Good	Good	Excellent	Good	Good	Fair	Good	Excellent	Good-Fair

NOTE: The above is representative of performance. For specific compound performance, consult Customer Service.

Decimal Conversion Factors

FRACTIONS, DECIMALS AND MILLIMETER CONVERSION CHART

FRACTIONS OF AN INCH						EQUIVALENTS		FRACTIONS OF AN INCH						EQUIVALENTS	
64	32	16	8	4	2	DECIMALS	mm	64	32	16	8	4	2	DECIMALS	mm
1						0.016	0.40	33						0.516	13.10
2	1					0.031	0.79	34	17					0.531	13.49
3						0.047	1.19	35						0.547	13.89
4	2	1				0.063	1.59	36	18	9				0.563	14.29
5						0.078	1.98	37						0.578	14.68
6	3					0.094	2.38	38	19					0.594	15.08
7						0.109	2.78	39						0.609	15.48
8	4	2	1			0.125	3.18	40	20	10	5			0.625	15.88
9						0.141	3.57	41						0.641	16.27
10	5					0.156	3.97	42	21					0.656	16.67
11						0.172	4.37	43						0.672	17.07
12	6	3				0.188	4.76	44	22	11				0.688	17.46
13						0.203	5.16	45						0.703	17.86
14	7					0.219	5.56	46	23					0.719	18.26
15						0.234	5.95	47						0.734	18.65
16	8	4	2	1		0.250	6.35	48	24	12	6	3		0.750	19.05
17						0.266	6.75	49						0.766	19.45
18	9					0.281	7.14	50	25					0.781	19.84
19						0.297	7.54	51						0.797	20.24
20	10	5				0.313	7.94	52	26	13				0.813	20.64
21						0.328	8.33	53						0.828	21.03
22	11					0.344	8.73	54	27					0.844	21.43
23						0.359	9.13	55						0.859	21.83
24	12	6	3			0.375	9.53	56	28	14	7			0.875	22.23
25						0.391	9.92	57						0.891	22.62
26	13					0.406	10.32	58	29					0.906	23.02
27						0.422	10.72	59						0.922	23.42
28	14	7				0.438	11.11	60	30	15				0.938	23.81
29						0.453	11.51	61						0.953	24.21
30	15					0.469	11.91	62	31					0.969	24.61
31						0.484	12.30	63						0.984	25.00
32	16	8	4	2	1	0.500	12.70	64	32	16	8	4	2	1.000	25.40

Unit Conversion Factors

CONVERSION FACTORS

UNIT	X	CONSTANT	=	UNIT
British Thermal Unit (BTU)		778.0		foot-pound (ft-lb)
British Thermal Unit (BTU)		1054.35		joules (j)
British Thermal Unit (BTU)		0.293		watt-hours (w-hr)
centimeters (cm)		0.032808		feet (ft)
centimeters (cm)		0.3937		inches (in)
centimeters (cm)		0.00001		kilometers (km)
centimeters (cm)		0.010		meters (m)
centimeters (cm)		10.0		millimeters (mm)
circular mils (cmil)		0.00064516		circular millimeters
circular mils (cmil)		0.000007854		inches ² (in ²)
circular mils (cmil)		0.00050671		square millimeters (mm ²)
circular mils (cmil)		0.7854		mils ²
cubic centimeter (cm ³)		0.000035314		cubic foot (ft ³)
cubic centimeter (cm ³)		0.061023		cubic inch (in ³)
cubic centimeter (cm ³)		0.000001		cubic meter (m ³)
cubic centimeter (cm ³)		0.00026417		gallons (gal)
cubic foot (ft ³)		1728.0		cubic in (in ³)
cubic foot (ft ³)		28317.847		cubic centimeter (cm ³)
cubic inch (in ³)		0.00057870		cubic feet (ft ³)
cubic inch (in ³)		0.000016387		cubic meter (m ³)
cubic inch (in ³)		16.387064		cubic centimeter (cm ³)
cubic meter (m ³)		1000000.0		centimeter (cm)
cubic meter (m ³)		35.314666		cubic foot (ft ³)
cubic meter (m ³)		264.17		gallons (gal)
feet (ft)		0.00018939		miles (mi)
feet (ft)		0.33333		yards (yd)
feet (ft)		12		inches (in)
feet (ft)		0.00030480		kilometer (km)
feet (ft)		0.30480		meters (m)
feet (ft)		30.480		centimeters (cm)
feet (ft)		304.80		millimeters (mm)
feet/pound (ft/lb)		0.00067197		meters/grams (m/g)
foot-pound (ft-lb)		0.001285		British Thermal Unit (BTU)
foot-pound (ft-lb)		1.356		joules (j)
foot-pound (ft-lb)		0.1383		kilogram/meter (kg/m)

UNIT	X	CONSTANT	=	UNIT
gallons (gal)		3.785411		liters (l)
gallons (gal)		0.13368		cubic foot (ft ³)
gallons (gal)		231.0		cubic inch (in ³)
gallons (gal)		3785.411		cubic centimeter (cm ³)
grams (g)		15.432		grains
gram/centimeter ³ (gm/cm ³)		0.0361275		pounds/in ³ (lb/in ³)
horsepower (hp)		33013.26		ft-lb/min
horsepower (hp)		550.0		ft-lb/sec
horsepower (hp)		745.7		watts (w)
inch (in)		0.027178		yards (yd)
inch (in)		0.083333		feet (ft)
inch (in)		0.00002540		kilometer (km)
inch (in)		0.025400		meter (m)
inch (in)		2.54000514		centimeter (cm)
inch (in)		25.4000514		millimeter (mm)
inch (in)		1000.0		mils
joules (j)		0.000948		British Thermal Unit (BTU)
joules (j)		10 ⁷		ergs
liters (l)		61.02374		cubic inch (in ³)
meters (m)		1.093611		yard (yd)
meters (m)		3.2808333		feet (ft)
meters (m)		39.37		inch (in)
meters (m)		100.0		centimeter (cm)
miles (mi)		1760.0		yards (yd)
miles (mi)		5280.0		feet (ft)
miles (mi)		1.6093		kilometer (km)
millimeters (mm)		0.0032808		feet (ft)
millimeters (mm)		0.03937		inch (in)
millimeters (mm)		0.001		meters (m)
millimeters (mm)		0.01		centimeters (cm)
millimeters (mm)		39.3701		mils
millimeters (mm)		1000.0		microns (μ)
watts (w)		44.25		ft-lb/minute
watts (w)		0.737562		ft-lb/sec
watts (w)		0.001341		horsepower
watt-hours (w-hr)		3.414462		British Thermal Unit (BTU)

Temperature Conversion Chart

To use this chart, find your known temperature (°F) in the shaded column.

°C	°F	°C	°F	°C	°F	°C	°F	°C	°F
-45.0	-49.0	-17.2	1.0	10.6	51.0	38.3	101.0	66.1	151.0
-44.4	-48.0	-16.7	2.0	11.1	52.0	38.9	102.0	66.7	152.0
-43.9	-47.0	-16.1	3.0	11.7	53.0	39.4	103.0	67.2	153.0
-43.3	-46.0	-15.6	4.0	12.2	54.0	40.0	104.0	67.8	154.0
-42.8	-45.0	-15.0	5.0	12.8	55.0	40.6	105.0	68.3	155.0
-42.2	-44.0	-14.4	6.0	13.3	56.0	41.1	106.0	68.9	156.0
-41.7	-43.0	-13.9	7.0	13.9	57.0	41.7	107.0	69.4	157.0
-41.1	-42.0	-13.3	8.0	14.4	58.0	42.2	108.0	70.0	158.0
-40.6	-41.0	-12.8	9.0	15.0	59.0	42.8	109.0	70.6	159.0
-40.0	-40.0	-12.2	10.0	15.6	60.0	43.3	110.0	71.1	160.0
-39.4	-39.0	-11.7	11.0	16.1	61.0	43.9	111.0	71.7	161.0
-38.9	-38.0	-11.1	12.0	16.7	62.0	44.4	112.0	72.2	162.0
-38.3	-37.0	-10.6	13.0	17.2	63.0	45.0	113.0	72.8	163.0
-37.8	-36.0	-10.0	14.0	17.8	64.0	45.6	114.0	73.3	164.0
-37.2	-35.0	-9.4	15.0	18.3	65.0	46.1	115.0	73.9	165.0
-36.7	-34.0	-8.9	16.0	18.9	66.0	46.7	116.0	74.4	166.0
-36.1	-33.0	-8.3	17.0	19.4	67.0	47.2	117.0	75.0	167.0
-35.6	-32.0	-7.8	18.0	20.0	68.0	47.8	118.0	75.6	168.0
-35.0	-31.0	-7.2	19.0	20.6	69.0	48.3	119.0	76.1	169.0
-34.4	-30.0	-6.7	20.0	21.1	70.0	48.9	120.0	76.7	170.0
-33.9	-29.0	-6.1	21.0	21.7	71.0	49.4	121.0	77.2	171.0
-33.3	-28.0	-5.6	22.0	22.2	72.0	50.0	122.0	77.8	172.0
-32.8	-27.0	-5.0	23.0	22.8	73.0	50.6	123.0	78.3	173.0
-32.2	-26.0	-4.4	24.0	23.3	74.0	51.1	124.0	78.9	174.0
-31.7	-25.0	-3.9	25.0	23.9	75.0	51.7	125.0	79.4	175.0
-31.1	-24.0	-3.3	26.0	24.4	76.0	52.2	126.0	80.0	176.0
-30.6	-23.0	-2.8	27.0	25.0	77.0	52.8	127.0	80.6	177.0
-30.0	-22.0	-2.2	28.0	25.6	78.0	53.3	128.0	81.1	178.0
-29.4	-21.0	-1.7	29.0	26.1	79.0	53.9	129.0	81.7	179.0
-28.9	-20.0	-1.1	30.0	26.7	80.0	54.4	130.0	82.2	180.0
-28.3	-19.0	-0.6	31.0	27.2	81.0	55.0	131.0	82.8	181.0
-27.8	-18.0	0.0	32.0	27.8	82.0	55.6	132.0	83.3	182.0
-27.2	-17.0	0.6	33.0	28.3	83.0	56.1	133.0	83.9	183.0
-26.7	-16.0	1.1	34.0	28.9	84.0	56.7	134.0	84.4	184.0
-26.1	-15.0	1.7	35.0	29.4	85.0	57.2	135.0	85.0	185.0
-25.6	-14.0	2.2	36.0	30.0	86.0	57.8	136.0	85.6	186.0
-25.0	-13.0	2.8	37.0	30.6	87.0	58.3	137.0	86.1	187.0
-24.4	-12.0	3.3	38.0	31.1	88.0	58.9	138.0	86.7	188.0
-23.9	-11.0	3.9	39.0	31.7	89.0	59.4	139.0	87.2	189.0
-23.3	-10.0	4.4	40.0	32.2	90.0	60.0	140.0	87.8	190.0
-22.8	-9.0	5.0	41.0	32.8	91.0	60.6	141.0	88.3	191.0
-22.2	-8.0	5.6	42.0	33.3	92.0	61.1	142.0	88.9	192.0
-21.7	-7.0	6.1	43.0	33.9	93.0	61.7	143.0	89.4	193.0
-21.1	-6.0	6.7	44.0	34.4	94.0	62.2	144.0	90.0	194.0
-20.6	-5.0	7.2	45.0	35.0	95.0	62.8	145.0	90.6	195.0
-20.0	-4.0	7.8	46.0	35.6	96.0	63.3	146.0	91.1	196.0
-19.4	-3.0	8.3	47.0	36.1	97.0	63.9	147.0	91.7	197.0
-18.9	-2.0	8.9	48.0	36.7	98.0	64.4	148.0	92.2	198.0
-18.3	-1.0	9.4	49.0	37.2	99.0	65.0	149.0	92.8	199.0
-17.8	0.0	10.0	50.0	37.8	100.0	65.6	150.0	93.3	200.0

TEMPERATURE CONVERSION FORMULA

$$^{\circ}\text{C} = \frac{5}{9} (^{\circ}\text{F} - 32)$$

$$^{\circ}\text{F} = \frac{9}{5} ^{\circ}\text{C} + 32$$



Conduit Capacity Chart

Conduit Trade Size	1/2	3/4	1	1 1/4	1 1/2	2	2 1/2	3	3 1/2	4	
I.D. Inches	0.622	0.824	1.049	1.380	1.610	2.067	2.731	3.356	3.834	4.334	
Internal Area, In ²	0.304	0.533	0.864	1.496	2.036	3.356	5.858	8.846	11.545	14.753	
1 Conductor (53% fill)	0.161	0.283	0.458	0.793	1.079	1.778	3.105	4.688	6.119	7.819	
2 Conductors (31% fill)	0.094	0.165	0.268	0.464	0.631	1.040	1.816	2.742	3.579	4.573	
Conductors (40% fill)	0.122	0.213	0.346	0.598	0.814	1.342	2.343	3.538	4.618	5.901	
Cable OD Inches	Cable Area In ²	Numbers listed below are based on the 2008 NEC (40% fill) for 3 or more non-lead covered cables.									
0.100	0.008	15	26	43	76	104	170	244	375	504	648
0.125	0.012	9	17	27	48	66	109	156	240	322	414
0.150	0.018	6	11	19	33	46	75	108	166	224	288
0.175	0.024	5	8	14	24	34	55	79	122	164	211
0.200	0.031	3	6	10	19	26	42	81	93	126	162
0.225	0.040	3	5	8	15	20	33	48	74	99	128
0.250	0.049	1	4	6	12	16	27	39	60	80	103
0.275	0.059	1	3	5	10	13	22	32	49	66	85
0.300	0.071	1	2	4	8	11	18	27	41	56	72
0.325	0.083	1	1	4	7	9	16	23	35	47	61
0.350	0.096	1	1	3	6	8	13	19	30	41	52
0.375	0.110	1	1	3	5	7	12	17	26	35	46
0.400	0.126	1	1	2	4	6	10	15	23	31	40
0.425	0.142	1	1	1	4	5	9	13	20	27	35
0.450	0.159	1	1	1	3	5	8	12	18	24	32
0.475	0.177	0	1	1	3	4	7	10	17	22	28
0.500	0.196	0	1	1	3	4	6	9	15	20	25
0.525	0.216	0	1	1	2	3	6	8	13	18	23
0.550	0.238	0	1	1	1	3	5	8	12	16	21
0.575	0.260	0	1	1	1	3	5	7	11	15	19
0.600	0.283	0	0	1	1	2	4	6	10	14	18
0.625	0.307	0	0	1	1	2	4	6	9	12	16
0.650	0.332	0	0	1	1	1	4	5	8	11	15
0.675	0.358	0	0	1	1	1	3	5	8	11	14
0.700	0.385	0	0	1	1	1	3	5	7	10	13
0.725	0.413	0	0	1	1	1	3	4	7	9	12
0.750	0.442	0	0	1	1	1	3	4	6	8	11
0.775	0.472	0	0	0	1	1	2	4	6	8	10
0.800	0.503	0	0	0	1	1	2	3	5	7	10
0.825	0.535	0	0	0	1	1	1	3	5	7	9
0.850	0.567	0	0	0	1	1	1	3	5	6	8
0.875	0.601	0	0	0	1	1	1	3	4	6	8
0.900	0.636	0	0	0	1	1	1	3	4	6	8
0.925	0.672	0	0	0	1	1	1	2	4	5	7
0.950	0.709	0	0	0	1	1	1	2	4	5	7
0.975	0.747	0	0	0	1	1	1	1	3	5	6
1.000	0.785	0	0	0	1	1	1	1	3	5	6
1.025	0.825	0	0	0	0	1	1	1	3	4	6
1.050	0.866	0	0	0	0	1	1	1	3	4	5
1.075	0.908	0	0	0	0	1	1	1	3	4	5

Notice: 1. The reader is cautioned to consult the 2008 NEC for specific information regarding conduit fill.
 2. This Conduit Capacity Chart should only be used as a guide when attempting to estimate conduit fill.
 3. For additional information, the reader should refer to the 2008 National Electrical Code, Chapter 9.

Coax Connector Cross Reference

BNC TYPE CONNECTORS

	CAMBRIDGE	GEM	LRC	RF INDUSTRIES	TROMPETER
CATALOG NUMBER	BNC CRIMP PLUG	BNC COMPRESSION PLUG	SNAP-N-SEAL	BNC CRIMP PLUG	BNC CRIMP PLUG
RG 6/U					
C3521	CPMC-68-36	—	—	RFB-1707-Q1	105-1516-9
C3523	CPMC-68-36	302-510CS	—	—	105-1516-9
C3524	CPMC-68-36	302-510CS	—	—	105-1516-9
C3525	CPMC-68-36	—	—	—	105-1516-9
C5760	CPMC-68-45	—	—	RFB-1707-Q1	105-1516-9
C5761	CPMC-68-45	302-5CSQS	SNS6BNC	—	UPL20-34
C5775	CPMC-68-45	302-5CSQS	SNS6BNC	—	105-1153-9
C5776	CPMC-68-45	—	SNS6BNC	—	105-1153-9
C5777	CPMC-68-45	—	SNS6BNC	RFB-1707-Q	105-1153-9
C5778	CPMC-68-45	—	SNS6BNC	RFB-1707-Q	105-1153-9
C5785	CPFI-UG88-3 (TWIST ON)	302-5CSQS	SNS6QSBNC	—	UPL20-41
C5802	CPMC-68-45	—	SNS6BNC	RFB-1707-Q	UPL20-41
C5804	CPMC-68-45	—	SNS6BNC	RFB-1707-Q	UPL20-41
C5814	CPMC-68-45	302-5CSQS	SNS6BNC	RFB-1707-Q	UPL20-41
C5822	CPMC-68-45	302-5CSQS	SNS6BNC	RFB-1707-Q	UPL20-41
C5886	CPMC-68-45	—	SNS6BNC	RFB-1707-Q	105-1153-9
C5889	CPFI-UG88-3 (TWIST ON)	302-5CSQS	SNS6QSBNC	—	UPL20-41
C8029	CPMC-68-45	302-5CS	SNS6BNC	RFB-1707-Q	UPL20-41
C8031	CPMC-68-36	—	—	RFB-1707-Q1	105-1516-9

	TROMPETER
CATALOG NUMBER	BNC CRIMP PLUG
RG 7/U	
C5851	PL20-48
C5853	105-1677-1
C5856	PL20-48
C5857	PL20-48

	AMP	CAMBRIDGE	GEM	KINGS ELECTRONICS	RF INDUSTRIES	TROMPETER
CATALOG NUMBER	BNC PLUG	BNC CRIMP PLUG	BNC CRIMP PLUG	BNC CRIMP PLUG	BNC PLUG	BNC CRIMP PLUG
RG 8/U						
C1108	—	CPMC-88-17	305-17	—	RFB-1107-1X	PL20-52
C1154	2-225295-1	—	—	KC-59-577 MO6	RFB-1101-1EN	PL20-6A
C1180	—	—	—	KC-59-642 MO6	RFB-1101-1EN	N/A
C1197	—	—	—	—	RFB-1101-1SI	PL20-6A
C1198	—	—	—	—	RFB-1101-1SI	PL20-6A

	CAMBRIDGE	GEM	RF INDUSTRIES	TROMPETER
CATALOG NUMBER	BNC CRIMP PLUG	BNC CRIMP PLUG	BNC CRIMP PLUG	BNC CRIMP PLUG
RG 11/U				
C1160	CPMC-88-26	305-26	RFB-1707-R1	UPL20-6A
C3528	CPMC-88-27	—	—	UPL20-6A
C3529	CPMC-88-28	—	—	UPL20-6A
C5011	CPMC-88-29	—	RFB-1707-R	UPL20-6A
C5025	CPMC-88-30	—	RFB-1707-R	UPL20-6A
C5029	CPMC-88-30	—	RFB-1707-R	UPL20-6A
C5034	CPMC-88-32	—	RFB-1707-R	UPL20-6A
C5039	CPMC-88-33	—	RFB-1707-R	UPL20-6A
C5043	CPMC-88-35	—	RFB-1707-R	UPL20-6A
C5044	CPMC-88-36	—	RFB-1707-R	UPL20-6A

**CAROL
BRAND**

AMP
Cambridge
GEM
Ideal
Kings Electronics
RF Industries
Trompeter

www.tycoelectronics.com
www.cambridgeconnectors.com
www.gemelec.com
www.idealindustries.com
www.kingselectronics.com
www.rfindustries.com
www.trompeter.com

 **General Cable**

Coax Connector Cross Reference

BNC TYPE CONNECTORS

	AMP	CAMBRIDGE	GEM	IDEAL	KINGS ELECTRONICS	RF INDUSTRIES	TROMPETER
CATALOG NUMBER	BNC PLUG	BNC CRIMP PLUG	BNC CRIMP PLUG	BNC PLUG	BNC CRIMP PLUG	BNC CRIMP PLUG	BNC CRIMP PLUG
RG 58/U							
C1117	22709-5	CPMC-88-1	305-1	IA-3620	755-115-5	RFB-1106-2	PL20-1
C1155	22709-5	CPMC-88-1	305-1	IA-3620	755-115-5	RFB-1106-2	PL20-1
C1166	22709-5	CPMC-88-1	305-1	IA-3620	755-115-5	RFB-1106-2	PL20-1
C1178	22709-5	CPMC-88-1	305-1	IA-3620	755-115-5	RFB-1106-2	PL20-1
C1188	22709-5	CPMC-88-1	305-1	IA-3620	-	RFB-1106-2	PL20-1
C3519	6-22709-8	CPMC-88-11	305-11	-	-	RFB-1707-7	PL20-4
C3579	6-22709-8	CPMC-88-11	305-11	IA-3623	-	RFB-1707-7	PL20-4
C5779	6-22709-8	CPMC-88-1	305-1	-	-	-	105-1598-1

	AMP	CAMBRIDGE	GEM	KINGS ELECTRONICS	LRC	RF INDUSTRIES	TROMPETER
CATALOG NUMBER	BNC PLUG	BNC CRIMP PLUG	BNC COMPRESSION PLUG	BNC CRIMP PLUG	SNAP-N-SEAL BNC	BNC CRIMP PLUG	BNC CRIMP PLUG
RG 59/U							
C1102	-	CPMC-78-2	307-2 (Crimp)	-	SNS59BNC	RFB-1707-D1	UPL20-2
C1103	-	CPMC-78-2	307-2CS	-	-	RFB-1707-D1	UPL20-2
C1104	-	CPMC-78-2	307-2 (Crimp)	-	SNS59BNC	RFB-1707-D	UPL20-2
C1106	-	CPMC-78-2	307-2 (Crimp)	-	SNS59BNC	RFB-1707-D	UPL20-2
C1110	-	CPMC-78-2	307-2 (Crimp)	-	SNS59BNC	RFB-1707-D	UPL20-2
C1112	-	CPMC-78-2	307-2 (Crimp)	-	SNS59BNC	RFB-1707-D	UPL20-2
C1135	-	CPMC-78-2	307-2 (Crimp)	-	SNS59BNC	RFB-1707-D	UPL20-2
C1142	-	CPMC-68-35	307-2CS	-	SNS59BNC	RFB-1707-W	UPL20-2A
C1158	-	CPMC-78-18	307-18 (Crimp)	-	-	-	UPL20-22
C3500	-	CPMC-68-35	302-10CS	-	-	-	105-1287-9
C3526	-	CPMC-68-50	-	-	-	-	105-1184-9
C3527	-	CPMC-68-35	-	-	-	-	UPL20-53
C5770	-	CPMC-68-35	302-2CS	-	-	RFB-1707-W	UPL20-2A
C5780	-	CPMC-68-35	302-2CS	-	SNS59BNC	RFB-1707-W	UPL20-2A
C5784	-	CP-88-4 (TWIST ON)	-	-	-	-	105-1558-9
C5830	-	CPMC-78-2	307-2 (Crimp)	-	SNS59BNC	RFB-1707-D1	UPL20-2
C8025	-	CPMC-78-2	302-10CS	-	-	RFB-1707-D	UPL20-2
C8027	-	CPMC-78-2	302-10CS	-	-	-	UPL20-2
C8028	-	CPMC-78-2	307-2 (Crimp)	-	SNS59BNC	-	UPL20-2
C8030	-	CPMC-68-10	-	-	-	RFB-1707-D3	105-1287-9

	AMP	CAMBRIDGE	GEM	KINGS ELECTRONICS	TROMPETER
CATALOG NUMBER	BNC PLUG	BNC CRIMP PLUG	BNC CRIMP PLUG	BNC CRIMP PLUG	BNC CRIMP PLUG
RG 62/U					
C1162	22709-7	CPMC-78-2	307-2	755-155-5	UPL20-2
C1164	22709-7	CPMC-78-2	307-2	755-155-5	UPL20-2
C3520	4-22709-9	CPMC-68-2	-	-	105-1287-1

	AMP	CAMBRIDGE	GEM	KINGS ELECTRONICS	RF INDUSTRIES	TROMPETER
CATALOG NUMBER	BNC PLUG	BNC CRIMP PLUG	BNC CRIMP PLUG	BNC CRIMP PLUG	BNC CRIMP PLUG	BNC CRIMP PLUG
RG 174/U						
C1156	1-22709-6	CPMC-88-19	305-19	KC-59-557 M06	RFB-1106-5	PL20-5

	AMP	CAMBRIDGE	GEM	RF INDUSTRIES	TROMPETER
CATALOG NUMBER	BNC PLUG	BNC CRIMP PLUG	BNC CRIMP PLUG	BNC CLAMP PLUG	BNC CLAMP PLUG
RG 213 /U					
C1176A	2-225395-1	CPMC-88-26	305-26	RFB-1101-1SI	PL20-6A



AMP
Cambridge
GEM
Ideal
Kings Electronics
RF Industries
Trompeter

www.tycoelectronics.com
www.cambridgeconnectors.com
www.gemelec.com
www.idealindustries.com
www.kingselectronics.com
www.rfindustries.com
www.trompeter.com



Coax Connector Cross Reference

F-TYPE CONNECTORS

CATALOG NUMBER	CAMBRIDGE	GEM	GILBERT		IDEAL INDUSTRIES
	F-TYPE CRIMP	F-TYPE COMPRESSION	F-TYPE CRIMP	F-TYPE COMPRESSION	F-TYPE
RG 6/U					
C3521	CPF-56-ALM	0406-4 (Crimp)	GF-6-AHS/USA	Contact Gilbert	-
C3523	CPF-56-ALM	0406-610CS	NS-8101-15	Contact Gilbert	-
C3524	CPF-56-ALM	0406-610CS	Contact Gilbert	Contact Gilbert	-
C3525	CPF-56-ALM	0406-4 (Crimp)	Contact Gilbert	Contact Gilbert	-
C5760	CPF-56-ALM	0406-4 (Crimp)	GF-6-AHS/USA	GF-UR-6	-
C5761	CPF-56-ALM	0406-6CSQS	GF-6-AHS/USA	GF-UR-6	85-037
C5775	CPF-56-ALM	0406-6CSQS	GF-6-AHS/USA	GF-UR-6	85-037
C5776	CPF-56-ALM	0406-4 (Crimp)	GF-6-AHS/USA	GF-UR-6	85-037
C5777	CPF-56-ALM	0406-4 (Crimp)	GF-6-AHS/USA	GF-UR-6	85-037
C5778	CPF-56-ALM	0406-4 (Crimp)	GF-6-AHS/USA	GF-UR-6	-
C5785	CPF-56-ALM	0406-6CSQS	GF-6-AHS/USA	GF-UR-6	85-057
C5802	CPF-56-ALM	0406-4 (Crimp)	GF-6-AHS/USA	GF-UR-6	85-037
C5804	CPF-56-ALMWP	-	GF-6-AHS/USA	GF-UR-6	85-037
C5814	CPF-56-ALM	0406-6CSQS	GF-6-AHS/USA	GF-UR-6	85-037
C5822	CPF-56-ALM	0406-6CSQS	GF-6-AHS/USA	GF-UR-6	85-037
C5886	CPF-56-ALM	0406-4 (Crimp)	GF-6-AHS/USA	GF-UR-6	85-037
C5889	CPF-56-ALS	0406-6CSQS	GF-6-AHS/USA	GF-UR-6	85-057
C8029	CPF-56-ALM	0406-6CS	Contact Gilbert	Contact Gilbert	-
C8031	CPF-56-ALM	0406-4 (Crimp)	Contact Gilbert	Contact Gilbert	-

CATALOG NUMBER	LRC		PPC			TROMPETER
	F-TYPE CRIMP	SNAP-N-SEAL	U SERIES U-INDOOR SU-OUTDOOR	UV SERIES UV-INDOOR SUV INDOOR/OUTDOOR	EX INDOOR/OUTDOOR	F-TYPE CRIMP
RG 6/U (cont.)						
C3521	-	-	CFS 6 PL	-	EX6P or EX6XLP	-
C3523	-	-	CFS 6 PL	-	EX6P or EX6XLP	-
C3524	-	-	CFS 6 PL	-	EX6P or EX6XLP	-
C3525	-	-	-	-	-	-
C5760	-	-	CFS 6 U (SU)	CFS 6 UV (SUV)	EX6 or EX6XLP	-
C5761	AMF6	SNS6	CFS 6 U (SU)	CFS 6 UV (SUV)	EX6 or EX6XLP	PL130SC-020
C5774	AMF6	SNS6	CFS 6 U (SU)	CFS 6 UV (SUV)	EX6 or EX6XLP	PL130SC-020
C5775	AMF6	SNS6	CFS 6 U (SU)	CFS 6 UV (SUV)	EX6 or EX6XLP	-
C5776	AMF6	SNS6	CFS 6 U (SU)	CFS 6 UV (SUV)	EX6 or EX6XLP	PL130SC-020
C5777	AMF6	SNS6	CFS 6 U (SU)	CFS 6 UV (SUV)	EX6 or EX6XLP	PL130SC-020
C5778	AMF6	SNS6	CFS 6 U (SU)	CFS 6 UV (SUV)	EX6 or EX6XLP	PL130SC-020
C5785	AMF6	SNS6QS	CFS 6 U (SU)	CFS 6 UV (SUV)	EX6 or EX6XLP	-
C5802	AMF6	SNS6	CFS 6 U (SU)	CFS 6 UV (SUV)	EX6 or EX6XLP	PL130SC-020
C5804	AMF6	SNS6	CFS 6 U (SU)	CFS 6 UV (SUV)	EX6 or EX6XLP	PL130SC-020
C5810	-	-	-	-	-	PL130SC-017
C5812	-	-	CFS 6 U (SU)	CFS 6 UV (SUV)	EX6 or EX6XLP	-
C5814	AMF6	SNS6	CFS 6 U (SU)	CFS 6 UV (SUV)	EX6 or EX6XLP	PL130SC-020
C5822	AMF6	SNS6	CFS 6 U (SU)	CFS 6 UV (SUV)	EX6 or EX6XLP	PL130SC-020
C5824	AMF6	SNS6	CFS 6 U (SU)	CFS 6 UV (SUV)	EX6 or EX6XLP	PL130SC-020
C5826	AMF6	SNS6	CFS 6 U (SU)	CFS 6 UV (SUV)	EX6 or EX6XLP	PL130SC-020
C5886	AMF6	SNS6	CFS 6 U (SU)	CFS 6 UV (SUV)	EX6 or EX6XLP	-
C5888	AMF6	SNS6	CFS 6 U (SU)	CFS 6 UV (SUV)	EX6 or EX6XLP	PL130SC-020
C5889	AMF6	SNS6QS	-	-	-	-
C5890	AMF6	SNS6	-	-	-	PL130SC-020
C8029	AMF6	SNS6	-	-	-	PL130SC-020
C8031	-	-	-	-	-	-



AMP
Cambridge
GEM
Ideal
Kings Electronics
RF Industries
Trompeter

www.tycoelectronics.com
www.cambridgeconnectors.com
www.gemelec.com
www.idealindustries.com
www.kingselectronics.com
www.rfindustries.com
www.trompeter.com



Coax Connector Cross Reference

F-TYPE CONNECTORS

CATALOG NUMBER	GILBERT		LRC		PPC		
	F-TYPE CRIMP	F-TYPE COMPRESSION	F-TYPE CRIMP	SNAP-N-SEAL	U SERIES U-INDOOR SU-OUTDOOR	PNU SERIES PNU-INDOOR PNSU INDOOR/ OUTDOOR	EX INDOOR/OUTDOOR
RG 7/U							
C5851	GAF-236/051-AHS/368	GAF-UST-7	AMF7	SNS7B	CFS 7 U (SU)	CFS 7 PNU (PNSU)	EX 7
C5853	GAF-236/051-AHS/368	GAF-UST-7	-	-	CFS 7 U (SU)	CFS 7 PNU (PNSU)	EX 7
C5856	GAF-236/051-AHS/368	GAF-UST-7	-	-	CFS 7 U (SU)	CFS 7 PNU (PNSU)	EX 7
C5857	GAF-236/051-AHS/398	GAF-UST-7Q	-	-	CFS 7 U (SU)	CFS 7 PNU (PNSU)	-

CATALOG NUMBER	CAMBRIDGE	GILBERT		LRC		PPC		EX INDOOR/ OUTDOOR
	F-TYPE CRIMP	F-TYPE CRIMP	F-TYPE COMPRESSION	F-TYPE CRIMP	SNAP-N-SEAL	U SERIES U-INDOOR SU-OUTDOOR	UV SERIES UV-INDOOR SUB INDOOR/ OUTDOOR	
RG 11/U								
C1160	CPF-11-ALM	Contact Gilbert	Contact Gilbert	-	-	-	-	-
C3528	CPF-11-ALM	Contact Gilbert	Contact Gilbert	-	-	-	-	-
C3529	CPF-11-ALM	Contact Gilbert	Contact Gilbert	-	-	-	-	-
C5011	CPF-11-ALM	GF-11-AHS/460	GAF-UST-11	AMF11	SNS11AS	CFS 11 U (SU)	CFS 11 PNU (PNSU)	EX 11
C5025	CPF-11-ALM	Contact Gilbert	Contact Gilbert	-	-	CFS 11 U (SU)	CFS 11 PNU (PNSU)	EX 11
C5029	CPF-11-ALM	GF-11-AHS/460	GAF-UST-11	AMF11	SNS11AS	CFS 11 U (SU)	CFS 11 PNU (PNSU)	EX 11
C5034	CPF-11-ALM	GF-11-AHS/460	GAF-UST-11	AMF11	SNS11AS	CFS 11 U (SU)	CFS 11 PNU (PNSU)	EX 11
C5039	CPF-11-ALM	GF-11-AHS/460	GAF-UST-11	AMF11	SNS11AS	CFS 11 U (SU)	CFS 11 PNU (PNSU)	EX 11
C5043	CPF-11-ALM	GF-11-AHS/460	GAF-UST-11	AMF11	SNS11AS	CFS 11 U (SU)	CFS 11 PNU (PNSU)	EX 11
C5044	-	GF-11-AHS/480	GAF-UST-11Q	AMF11	SNS11AS	CFS 11 U (SU)	CFS 11 PNU (PNSU)	EX 11

CATALOG NUMBER	CAMBRIDGE	GEM	GILBERT		IDEAL INDUSTRIES	LRC	
	F-TYPE CRIMP	F-TYPE COMPRESSION	F-TYPE CRIMP	F-TYPE COMPRESSION	F-TYPE	F-TYPE CRIMP	SNAP-N-SEAL
RG 59/U							
C1102	CPF-59-ALM	0459-2M (Crimp)	GF-59-AHS/USA	GF-UR-59	85-036	AMF59	SNS59
C1103	CPF-59-ALM	0459-2CS	GF-59-AHS/USA	GF-UR-59	85-036	-	-
C1104	CPF-59-ALM	0459-2M (Crimp)	GF-59-AHS/USA	GF-UR-59	85-036	AMF59	SNS59
C1106	CPF-59-ALM	0459-2M (Crimp)	GF-59-AHS/USA	GF-UR-59	85-036	AMF59	SNS59
C1110	CPF-59-ALM	0459-2M (Crimp)	GF-59-AHS/USA	GF-UR-59	85-036	AMF59	SNS59
C1112	CPF-59-ALM	0459-2M (Crimp)	GF-59-AHS/USA	GF-UR-59	85-036	AMF59	SNS59
C1135	CPF-59-ALM	0459-2M (Crimp)	GF-59-AHS/USA	GF-UR-59	85-036	AMF59	SNS59
C1142	CPF-59-ALM	0459-2CS	GF-59-AHS/USA	GF-UR-59	85-036	AMF59	SNS59
C1158	-	-	GF-1097-17	Contact Gilbert	-	-	-
C3500	-	0459-10CS	Contact Gilbert	Contact Gilbert	-	-	-
C3526	-	-	Contact Gilbert	Contact Gilbert	-	-	-
C3527	CPF-59-ALM	0459-2M (Crimp)	Contact Gilbert	Contact Gilbert	-	-	-
C5770	CPF-59-ALM	0459-2CS	Contact Gilbert	Contact Gilbert	85-036	-	-
C5780	CPF-59-ALM	0459-2M (Crimp)	GF-59-AHS/USA	GF-UR-59	85-036	AMF59	SNS59
C5784	-	-	GF-59-AHS/357	Contact Gilbert	85-059	-	SNS59QS
C5830	CPF-59-ALM	0459-2M (Crimp)	GF-59-AHS/USA	GF-UR-59	85-036	AMF59	SNS59
C8025	CPF-59-ALM	0459-10CS	Contact Gilbert	Contact Gilbert	-	-	-
C8027	CPF-59-ALM	0459-10CS	Contact Gilbert	Contact Gilbert	-	-	-
C8028	CPF-59-ALM	0459-2M (Crimp)	Contact Gilbert	Contact Gilbert	-	AMF59	SNS59
C8030	CPF-59-ALM	0459-2M (Crimp)	Contact Gilbert	Contact Gilbert	-	-	-



AMP
Cambridge
GEM
Ideal
Kings Electronics
RF Industries
Trompeter

www.tycoelectronics.com
www.cambridgeconnectors.com
www.gemelec.com
www.idealindustries.com
www.kingselectronics.com
www.rfindustries.com
www.trompeter.com



Coax Connector Cross Reference

F-TYPE CONNECTORS

CATALOG NUMBER	PPC			TROMPETER
	U SERIES U-INDOOR SU-OUTDOOR	UV SERIES UV-INDOOR SUV INDOOR/ OUTDOOR	EX INDOOR/OUTDDOR	F-TYPE CRIMP
RG 59/U (cont.)				
C1102	CFS 59 U (SU)	CFS 59 UV (SUV)	EX59 or EX59XL	PL130SC-014
C1103	CFS 59 U (SU)	CFS 59 UV (SUV)	EX59 or EX59XL	PL130SC-013
C1104	CFS 59 U (SU)	CFS 59 UV (SUV)	EX59 or EX59XL	PL130SC-013
C1106	CFS 59 U (SU)	CFS 59 UV (SUV)	EX59 or EX59XL	PL130SC-013
C1110	CFS 59 U (SU)	CFS 59 UV (SUV)	EX59 or EX59XL	PL130SC-013
C1112	CFS 59 U (SU)	CFS 59 UV (SUV)	EX59 or EX59XL	PL130SC-013
C1135	CFS 59 U (SU)	CFS 59 UV (SUV)	EX59 or EX59XL	PL130SC-013
C1142	CFS 59 U (SU)	CFS 59 UV (SUV)	EX59 or EX59XL	PL130SC-023
C1158	-	-	-	PL130SC-008
C3500	-	-	-	-
C3526	-	-	-	-
C3527	CFS 59 U (SU)	CFS 59 UV (SUV)	EX59 or EX59XL	PL130SC-023
C5770	CFS 59 U (SU)	CFS 59 UV (SUV)	EX59 or EX59XL	PL130SC-022
C5780	CFS 59 U (SU)	CFS 59 UV (SUV)	EX59 or EX59XL	PL130SC-023
C5784	CFS 59 U (SU)	CFS 59 UV (SUV)	EX59 or EX59XL	-
C5830	CFS 59 U (SU)	CFS 59 UV (SUV)	EX59 or EX59XL	PL130SC-013A
C8025	-	-	-	PL130SC-013
C8027	-	-	-	PL130SC-013
C8028	-	-	-	PL130SC-013A
C8030	-	-	-	-

TROMPETER	
CATALOG NUMBER	F-TYPE CRIMP
RG 62/U	
C1162	PL130SC-013
C1164	PL130SC-013
C3520	-

TROMPETER	
CATALOG NUMBER	F-TYPE CRIMP
RG 174/U	
C1156	PL130SC-004

**CAROL
BRAND**

AMP
Cambridge
GEM
Ideal
Kings Electronics
RF Industries
Trompeter

www.tycoelectronics.com
www.cambridgeconnectors.com
www.gemelec.com
www.idealindustries.com
www.kingselectronics.com
www.rfindustries.com
www.trompeter.com

 **General Cable**

Coax Connector Cross Reference

N-TYPE CONNECTORS

TROMPETER	
CATALOG NUMBER	N-TYPE CRIMP PLUG
RG 6/U	
C3521	—
C3523	—
C3524	—
C3525	—
C5760	—
C5761	UPL95-34
C5775	—
C5776	—
C5777	—
C5778	—
C5785	—
C5802	—
C5804	—
C5814	—
C5822	UPL95-41
C5886	—
C5889	UPL95-41
C8029	UPL95-41
C8031	—

TROMPETER	
CATALOG NUMBER	N-TYPE CRIMP PLUG
RG 7/U	
C5851	PL95-48
C5853	N/A
C5856	PL95-48
C5857	PL95-48

	AMP	CAMBRIDGE	KINGS ELECTRONICS	LRC	RF INDUSTRIES	TROMPETER
CATALOG NUMBER	N-TYPE PLUG	N-TYPE CRIMP PLUG	N-TYPE CRIMP PLUG	N-TYPE PLUG	N-TYPE CRIMP PLUG	N-TYPE PLUG
RG 8/U						
C1108	—	—	—	—	RFN-1007-2SX	—
C1154	225661-2 (Mil)	CPN-68-8	KN-59-176	—	RFN-1006-3E	PL95-6A
	415232-6				RFN-1006-3E	
C1180	—	CPN-8/110	1205-4-9	NM8HB10	RFN-1006-3I	—
C1198	1-225661-6 (Mil)	CPN-68-8	1205-4-9	—	RFN-1006-3I	PL95-6A
	414160-4					

	CAMBRIDGE	TROMPETER
CATALOG NUMBER	N-TYPE CRIMP PLUG	N-TYPE CRIMP PLUG
RG 11/U		
C1160	CPN-8	UPL95-6A
C3528	CPN-8	UPL95-6A
C3529	CPN-8	UPL95-6A
C5011	CPN-8	UPL95-6A
C5025	CPN-68-8	UPL95-6A
C5029	CPN-8	UPL95-6A
C5034	CPN-8	UPL95-6A
C5039	CPN-8	UPL95-6A
C5043	CPN-8	UPL95-6A
C5044	CPN-68-8	UPL95-6A



AMP
Cambridge
GEM
Ideal
Kings Electronics
RF Industries
Trompeter

www.tycoelectronics.com
www.cambridgeconnectors.com
www.gemelec.com
www.idealindustries.com
www.kingselectronics.com
www.rfindustries.com
www.trompeter.com



Coax Connector Cross Reference

N-TYPE CONNECTORS

CATALOG NUMBER	AMP N-TYPE PLUG	CAMBRIDGE N-TYPE CRIMP PLUG	KINGS ELECTRONICS N-TYPE CRIMP PLUG	RF INDUSTRIES N-TYPE CRIMP PLUG	TROMPETER N-TYPE CRIMP PLUG
RG 58/U					
C1117	1-225661-2 (Mil)	CPN-68-1	1205-19-5	RFN-1005-3C	PL95-1
	415232-2				
C1155	1-225661-2 (Mil)	CPN-68-1	1205-19-5	RFN-1005-3C	PL95-1
	415232-2				
C1166	1-225661-2 (Mil)	CPN-68-1	1205-19-5	RFN-1005-3C	PL95-1
	415232-2				
C1178	1-225661-2 (Mil)	CPN-68-1	1205-19-5	RFN-1005-3C	PL95-1
	415232-2				
C1188	1-225661-2 (Mil)	CPN-68-1	—	RFN-1005-3C	PL95-1
	415232-2				
C3519	—	CPN-1	—	—	PL95-4
C3579	—	CPN-1	—	—	PL95-4
C5779	—	CPN-1	—	—	—

CATALOG NUMBER	AMP N-TYPE PLUG	CAMBRIDGE N-TYPE CRIMP PLUG	GEM N-TYPE CRIMP PLUG	RF INDUSTRIES N-TYPE CRIMP PLUG	TROMPETER N-TYPE CRIMP PLUG
RG 59/U					
C1102	—	—	—	RFN-1907-2S	UPL95-2
C1103	—	CPN-2	400-2	RFN-1907-2S	UPL95-2
C1104	—	CPN-2	400-2	RFN-1907-2S	UPL95-2
C1106	—	CPN-2	400-2	RFN-1907-2S	UPL95-2
C1110	—	CPN-2	400-2	RFN-1907-2S	UPL95-2
C1112	—	CPN-2	400-2	RFN-1907-2S	UPL95-2
C1135	—	CPN-2	400-2	RFN-1907-2S	UPL95-2
C1142	—	—	—	—	UPL95-2A
C1158	—	—	—	—	UPL95-22
C3500	—	—	—	—	—
C3526	—	—	—	—	—
C3527	—	—	—	—	—
C5770	—	—	—	—	UPL95-2A
C5780	—	—	—	—	UPL95-2A
C5784	—	—	—	—	—
C5830	—	—	—	RFN-1907-2S	UPL95-2
C8025	—	CPN-2	400-2	—	UPL95-2
C8027	—	CPN-2	400-2	—	UPL95-2
C8028	—	—	—	—	UPL95-2
C8030	—	—	—	—	—

**CAROL
BRAND**

AMP
Cambridge
GEM
Ideal
Kings Electronics
RF Industries
Trompeter

www.tycoelectronics.com
www.cambridgeconnectors.com
www.gemelec.com
www.idealindustries.com
www.kingselectronics.com
www.rfindustries.com
www.trompeter.com

 **General Cable**

Coax Connector Cross Reference

N-TYPE CONNECTORS

	AMP	CAMBRIDGE	GEM	TROMPETER
CATALOG NUMBER	N-TYPE PLUG	N-TYPE CRIMP PLUG	N-TYPE CRIMP PLUG	N-TYPE PLUG
RG 62/U				
C1162	—	CPN-2	400-2	UPL95-2
C1164	—	CPN-2	400-2	UPL95-2
C3520	—	—	—	—

	AMP	RF INDUSTRIES	TROMPETER
CATALOG NUMBER	N-TYPE PLUG	N-TYPE PLUG	N-TYPE PLUG
RG 174/U			
C1156	—	RFN-1005-B-03	PL95-5

	AMP	CAMBRIDGE	KINGS ELECTRONICS	RF INDUSTRIES	TROMPETER
CATALOG NUMBER	N-TYPE PLUG	N-TYPE CRIMP PLUG	N-TYPE CRIMP PLUG	N-TYPE PLUG	N-TYPE PLUG
RG 213/U					
C1176A	1-227086-0 (MIL)	CPN-68-8	KN-59-202	RFN-1006-3I	PL95-6A
	415232-6				

ONE-PIECE CONNECTORS

GENERAL CABLE	WHITE SANDS ENGINEERING ONE-PIECE CONNECTOR
RG 6/U	
395025	SLC59
	SLCUHEC2
395011	SLC6/SLC6O
	SLC6Q/SLC6QO
395025	BNCFP59
395025	BNCFPSLC59
	BNCFPSLCHEC
395011	BNCFP6
395011	BNCFPSLC6/BNCFPSLC6G
	BNCFPSLC6Q/BNCFPSLC6QG
395025	RCAFP59
395025	RCAFPSLC59/RCAFPSLC59G
395011	RCAFPSLC6/RCAFPSLC6G
	RCAFPSLC6QG

AWG Conductor Chart

COPPER CONDUCTOR DATA

The conductors used by General Cable meet the applicable requirements of ASTM specifications B-3, B-33, B-172, B-173, B-174 and B-286 and Federal Specification QQ-W-343.

The following data covers the more commonly used conductor constructions in the electrical and electronics industry. Special constructions, not shown, are available or can be designed to meet specific requirements. It is suggested that the General Cable Product Engineering Department be contacted before a specification is finalized.

AWG	STRANDING	TYPE STRANDING ⁽¹⁾	DIAMETER ⁽⁴⁾		AREA		WEIGHT		D.C. RESISTANCE 20°C ⁽²⁾				BREAK STR. LBS.
			in	mm	circ. mils	sq. mm	lbs/Mft	kg/km	TIN COATING ⁽³⁾		BARE OF SILVER COATING		
									Ω/Mft	Ω/km	Ω/Mft	Ω/km	
32	7/40	Co or Bu	.0096	.254	100	.051	.21	.31	176.00	577.00	164.00	538.00	1.986
30	Solid 7/38	-	.010	.254	100	.051	.30	.45	113.00	371.00	104.00	340.00	3.157
		Bu	.012	.305	112	.057	.35	.52	106.00	348.00	92.60	303.00	
28	Solid 7/36	-	.01264	.321	159	.081	.48	.72	70.80	232.00	65.30	214.00	5.020
		Co	.015	.381	175	.089	.55	.82	67.50	221.00	59.30	194.00	
27	Solid 7/35	-	.0142	.361	202	.102	.61	.91	55.60	182.00	51.40	169.00	6.331
		Co or Bu	.017	.432	220	.111	.69	1.04	53.80	176.00	-	-	
26	Solid 7/34 10/36 19/38	-	.016	.404	253	.128	.77	1.14	44.50	146.00	41.00	135.00	7.983
		Co or Bu	.019	.483	278	.141	.87	1.29	42.50	139.00	37.30	122.00	
		Bu	.0193	.490	250	.127	.78	1.15	47.30	155.00	40.40	133.00	
		Bu or Co	.021	.533	304	.154	.97	1.44	38.90	128.00	34.10	112.00	
24	Solid 7/32 16/36 19/36	-	.0201	.511	404	.205	1.22	1.82	27.20	89.20	25.70	84.20	12.690
		Co or Bu	.024	.610	448	.227	1.38	2.05	25.70	84.20	23.10	75.90	
		Bu	.024	.610	400	.201	1.25	1.64	29.50	96.80	27.50	90.20	
		Co or Bu	.025	.635	475	.241	1.48	2.20	24.90	81.70	21.80	71.60	
22	Solid 7/30 19/34	-	.025	.643	643	.324	1.94	2.89	16.70	54.80	16.20	53.20	19.430
		Co or Bu	.030	.762	700	.355	2.19	3.26	16.60	54.40	14.80	48.60	
		Bu or Eq	.0315	.800	754	.382	2.35	3.50	15.50	50.80	13.80	45.10	
20	Solid 7/28 10/30 19/32 26/34	-	.032	.813	1,020	.519	3.10	4.61	10.50	34.40	10.10	33.20	30.890
		Co or Bu	.038	.965		.562	3.49	5.19	10.30	33.80	9.33	30.60	
		Bu	.037	.940	1,111	.507	3.14	4.67	11.40	37.40	10.40	34.00	
		Co, Bu or Eq	.040	1.02	1,000	.616	3.84	5.71	9.48	31.10	8.53	28.00	
		Bu	.039	.940	1,216	.523	3.28	4.88	11.30	37.10	-	-	
19	Solid 7/26 16/30 19/30 41/34	-	.0359	.912	1,032	.653	3.90	5.80	-	-	8.05	26.40	38.950
		Co or Bu	.0403	1.024	1,290	.823	4.92	7.32	6.77	22.20	6.39	21.00	
		Bu	.048	1.22	1,620	.897	5.55	8.26	6.45	21.20	5.55	19.20	
		Co, Bu or Eq	.0475	1.207	1,770	.810	5.01	7.45	7.15	23.40	6.48	21.30	
		Bu	.050	1.27	1,600	.963	5.95	8.85	6.10	20.00	5.46	17.90	
16	Solid 19/294 19/.0117 26/30 65/34	-	.0508	1.29	1,627	1.31	7.81	11.60	4.47	14.70	4.16	13.60	78.100
		Bu or Eq	.057	1.45	2,580	1.23	7.52	11.20	4.82	15.80	4.27	14.00	
		Bu	.0585	1.50	2,426	1.32	8.02	11.90	4.39	14.40	4.13	13.50	
		Bu	.0606	1.54	2,601	1.32	8.15	12.10	4.39	14.40	3.99	13.10	
		Bu	.060	1.52	2,600	1.31	8.20	11.90	4.47	14.70	4.16	13.60	
14	Solid 7/.0242 19/274 19/.0147 41/30	-	.0641	1.63	2,581	2.08	12.4	18.50	2.68	8.79	2.52	8.28	124.200
		Co	.073	1.85	4,110	2.08	12.7	18.90	-	-	2.61	8.56	
		Co, Eq or Un	.071	1.80	4,100	1.94	12.1	18.00	3.05	10.00	2.71	8.88	
		Bu	.074	1.88	3,831	2.08	12.7	18.90	2.73	-	2.61	8.56	
		Bu	.077	1.96	4,106	2.08	12.9	19.20	2.81	9.22	2.53	8.30	
12	Solid 7/.0305 19/254 19/.0185 65/30	-	.0808	2.05	4,100	3.31	19.8	29.50	1.69	5.54	1.59	5.21	197.500
		Bu	.092	2.34	6,530	3.30	20.2	30.10	-	-	1.64	5.38	
		Co, Eq or Un	.0905	2.299	6,512	3.08	19.4	28.90	1.87	6.13	1.70	5.59	
		Cu	.0925	2.35	6,088	3.30	20.2	30.10	-	-	1.64	5.25	
		Bu	.094	2.388	6,503	3.29	20.8	31.10	1.82	5.97	1.64	5.25	
10	Solid 7/.0385 19/.0234 37/.0169 105/30	-	.1019	2.588	6,500	5.26	31.4	46.80	-	-	1.00	3.28	314.500
		Co	.116	2.95	10,380	5.25	32.0	47.60	-	-	1.00	3.28	
		Bu	.117	2.97	10,376	5.27	32.0	47.60	-	-	.98	3.21	
		Co	.112	2.84	10,404	4.74	29.2	43.40	-	-	1.25	4.10	
		Bu	.126	3.20	9,361	5.32	33.8	49.20	1.10	3.61	.99	3.24	
8	7/.0486 19/.0295 133/29 168/30	Bu	.146	3.71	10,500	8.38	50.1	74.50	-	-	.65	2.13	
		Bu or Eq	.144	3.66	16,534	8.38	50.0	74.40	-	-	.65	2.13	
		Ro 19 x 7/29	.169	4.293	16,535	8.61	54.0	80.40	.71	2.33	-	-	
		Ro 7 x 24/30	.174	4.42	16,983	8.51	53.4	79.00	.70	2.30	-	-	
6	19/.0374 133/27 266/30	Bu	.188	4.775	16,800	13.33	81.1	121.00	-	-	.40	1.30	
		Ro 19 x 7/27	.213	5.41	26,576	13.60	84.1	125.00	.43	1.41	-	-	
		Ro 7 x 38/30	.222	5.64	26,818	13.49	83.2	124.00	.44	1.44	-	-	
4	133/25 420/30	Ro 19 x 7/25	.257	6.53	26,600	21.61	135.0	201.00	.29	.95	-	-	
		Ro 7 x 60/30	.270	6.850	42,615	21.29	140.0	208.00	.28	.92	-	-	
2	665/30	Ro 19 x 35/30	.338	8.59	42,000	33.72	213.0	317.00	.18	.59	-	-	

(1) Bu - Bunched; Co - Concentric; Eq - Equilay; Ro - Rope; Un - Unilay
 (2) Typical DC resistance values for uninsulated wires. Multiply by 1.04 for typical values after insulation
 (3) Values are for tinned, heavy tinned, prefused, overcoated or topcoated conductors
 (4) Does not meet UL conductor stranding requirements



Cable Design Equations—Braid Shield

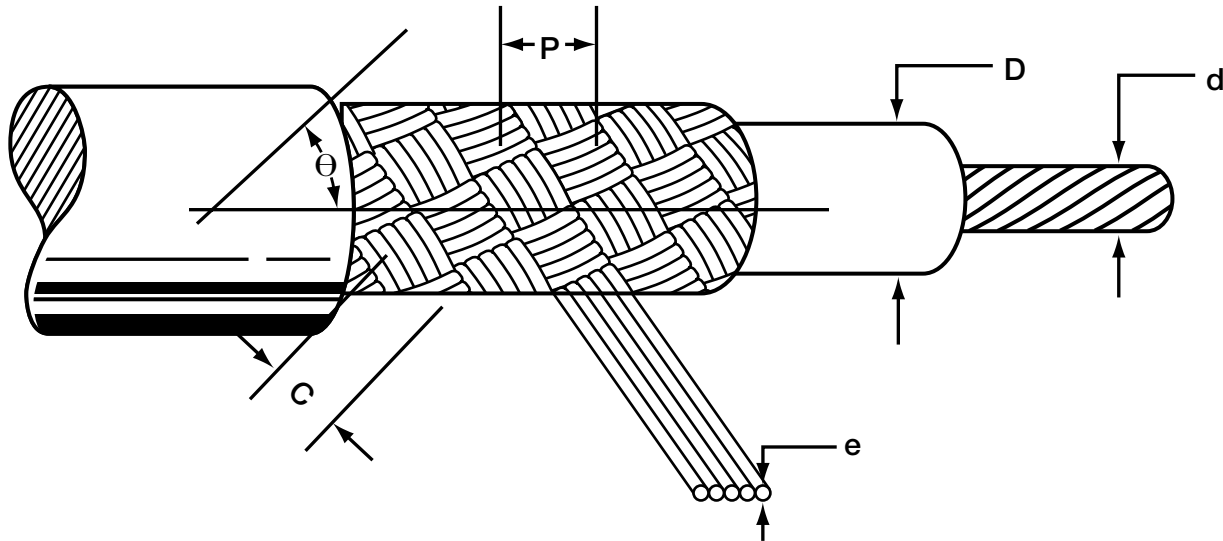

BRAID ANGLE:

$$\theta = \tan^{-1} \left[\frac{2\pi (D + 2e) P}{C} \right], \text{ DEGREES}$$

BRAID PICKS PER INCH:

$$P = \frac{(C) (\tan \theta)}{2\pi (M)}, \text{ PICKS/INCH}$$

BRAID SHIELD WEIGHT:

$$W = \frac{(n) (C) (l)}{\cos \theta}, \text{ LBS/M FT}$$

BRAID SHIELD DC RESISTANCE:

$$R_{dc} = \cos \frac{r_{dc}}{(n) (C) (\cos \theta)}, \Omega/\text{kft}$$

% Coverage: %C = (2F - F²) x-100

% Coverage Factor for Common Coverage:	
F	% Coverage
0.368	60
0.409	65
0.453	70
0.500	75
0.553	80
0.617	85

where:

- D = diameter under shield, inches
- d = diameter of center conductor, inches
- C = number of carriers
- e = diameter of end
- P = pick (measured in picks per linear inch)
- θ = braid angle, degrees
- W = weight of shield, lbs/M ft
- n = number of ends in one carrier
- l = weight of one end in lbs/M ft
- M = D + build-up of braid on one shield wall, inches
- R_{dc} = dc resistance of the braid shield, Ω/M ft
- r_{dc} = dc resistance of one strand (end) of shield, Ω/M ft
- % C = percent braid coverage
- F = % coverage factor

Cable Design Equations—Coaxial Cable

COAXIAL CABLE CAPACITANCE:

$$C = \frac{7.36\varepsilon}{\text{LOG} \left(\frac{D}{fd} \right)}, \text{ pF/ft}$$

COAXIAL CABLE INDUCTANCE:

$$L = 0.140 \text{ LOG} \left(\frac{D}{fd} \right), \mu\text{H/ft}$$

COAXIAL CABLE IMPEDANCE:

$$Z_0 = \frac{138}{\varepsilon^{1/2}} \text{ LOG} \left(\frac{D}{fd} \right), \Omega$$

COAXIAL CABLE VELOCITY OF PROPAGATION:

$$V_p = \frac{100}{\varepsilon^{1/2}}, \%$$

COAXIAL CABLE TIME DELAY:

$$t_d = 1.016 \varepsilon^{1/2}, \text{ nsec/ft}$$

COAXIAL CABLE CUTOFF FREQUENCY:

$$f_{CO} = \frac{7.50}{\varepsilon^{1/2} (D + fd)}, \text{ GHz}$$

where:

C = capacitance, pF/ft

ε = insulation dielectric constant (see table below)

D = diameter under the shield, inches

d = diameter of the center conductor, inches

L = inductance, $\mu\text{H/ft}$

f = strand factor (see Table II, page 194)

Z_0 = characteristic impedance, Ω

V_p = velocity of propagation, %

t_d = time delay, nsec/ft

f_{CO} = cutoff frequency, GHz

MATERIAL	ε	POWER FACTOR, PF
FEP Teflon® (Cellular)	1.40	0.0002
FEP Teflon® (Solid)	2.10	0.0003
PE (Cellular)	1.56	0.0003
PE (Solid)	2.26	0.0003
PE (Semi-Solid)	1.29	0.0003

Cable Design Equations—Balanced Pair

CAPACITANCE (UNSHIELDED TWISTED PAIR):

$$C = \frac{2.2 \epsilon}{\text{LOG} \left[\frac{1.3 (D)}{(f) (d)} \right]}, \text{ pF/ft}$$

IMPEDANCE (UNSHIELDED TWISTED PAIR):

$$Z_o = \frac{1016 \epsilon^{1/2}}{C}, \Omega$$

CAPACITANCE (SHIELDED TWISTED PAIR):

$$C = \frac{3.7 \epsilon}{\text{LOG} \left[\frac{1.2 (D)}{(f) (d)} \right]}, \text{ pF/ft}$$

IMPEDANCE (SHIELDED TWISTED PAIR):

$$Z_o = \frac{276}{\epsilon^{1/2}} \text{LOG} \left[\frac{1.2 (D)}{(f) (d)} \right], \Omega$$

CAPACITANCE (OVERALL SHIELDED & CABLED):

$$C = \frac{2.9 \epsilon}{\text{LOG} \left[\frac{1.5 (D)}{(f) (d)} \right]}, \text{ pF/ft}$$

IMPEDANCE (OVERALL SHIELDED & CABLED):

$$Z_o = \frac{347}{\epsilon^{1/2}} \text{LOG} \left[\frac{1.5 (D)}{(f) (d)} \right], \Omega$$

where:

- C = mutual capacitance, pF/ft
- ε = insulation dielectric constant (see Table I)
- f = stranding factor (see Table II)
- d = diameter of the conductor, inches
- D = diameter over the insulation, inches
- Z_o = characteristic impedance Ω

TABLE I

DIELECTRIC CONSTANTS & V _p OF INSULATIONS		
MATERIAL	ε	V _p , %
ECTFE (Halar™)	2.60	63
FEP	2.15	68
PFA Teflon®	2.15	68
PVC	5.00	45
PVC (Semi-rigid)	3.60	53
PVDF (Kynar™, SOLEF™)	7.70	36
Polyethylene	2.29	66
Polypropylene	2.25	67
Polyurethane	6.50	39
Rubber, butyl	4.0	50
Rubber, natural	5.0	45
Rubber, SBR	4.0	50
Rubber, silicone	3.1	57
TFE Teflon®	2.1	69
TPE	5.0	45
Teflon®	2.10	69
Tefzel®	2.6	62

TABLE II

NO. OF STRANDS	f
1	1.000
7	0.939
19	0.970
37	0.980
61	0.985
91	0.988

Engineering Prefixes

PREFIX	SYMBOL	MULTIPLYING FACTOR	
		SCIENTIFIC	CONVENTIONAL
tera	T	10^{12}	1,000,000,000,000
giga	G	10^9	1,000,000,000
mega	M	10^6	1,000,000
kilo	k	10^3	1,000
hecto	h	10^2	100
deca	da	10^1	10
deci	d	10^{-1}	0.1
centi	c	10^{-2}	0.01
milli	m	10^{-3}	0.001
micro	μ	10^{-6}	0.000001
nano	<i>n</i>	10^{-9}	0.000000001
pico	<i>p</i>	10^{-12}	0.000000000001
femto	<i>f</i>	10^{-15}	0.000000000000001
atto	<i>a</i>	10^{-18}	0.000000000000000001

Glossary

Abrasion Resistance: Resistance to surface wear.

AC Alternating Current (a.c.): Current in which the charge-flow periodically reverses and is represented by: $I = I_0 \cos(2\pi f t - \phi)$ where, I is the current, I_0 is the amplitude, f the frequency, ϕ the phase angle.

Accelerated Aging: A test that attempts to duplicate long-time environmental aging in comparatively short time spans.

Accelerator: A chemical additive which hastens a chemical reaction under specific conditions.

Accordion: (1) A retractile cable with a series of equally-spaced transverse folds. (2) A connector contact with a "Z" shaped flat spring to permit high deflection without overstress.

Adapter: A device that enables any or all of the following 1) different sizes or types of plugs to mate with one another or to fit into a telecommunications outlet/connector; 2) the rearrangement of leads; 3) large cables with numerous wires to fan out into smaller groups of wires, 4) interconnection between cables.

Adhesive Bonded: Cables bonded by adding an adhesive coating to the surface of the cable components, then joining and curing the adhesive to form a cable. See *Bonded Cable*.

Administration: The method for labeling, identification, documentation and usage needed to implement moves, additions and changes of the telecommunications infrastructure.

Admittance: The measure of the ease with which an alternating current flows in a circuit. The reciprocal of impedance.

Aerial Cable: A cable suspended in the air on poles or other overhead structure.

Aging: The change in properties of a material with time under specific conditions.

Air Core Cable: A cable in which the interstices in the cable core are not filled with a moisture barrier.

Air-Handling Plenum: A designated area, closed or open, used for environmental air.

Air Spaced Coaxial Cable: One in which air is essentially the dielectric material. A spirally wound synthetic filament, beads or braided filaments may be used to center the conductor.

All-Rubber Cable: A cable in which all interstices between conductors are filled with rubber compound.

Alligator Clip: A mechanical device shaped like alligator jaws used as a temporary connection on the end of interconnections wire.

Alloy: A metal formed by combining two or more different metals to obtain desirable properties.

Aluminum Conductor: An aluminum wire or group of wires not suitably insulated to carry electrical current.

Aluminum-Steel Conductor: A composite conductor made up of a combination of aluminum and steel wires.

Ambient Temperature: The temperature of a medium (gas or liquid) surrounding an object.

American Wire Gauge (AWG): The standard system used for designating wire diameter. The lower the AWG number, the larger the diameter. Also called the Brown and Sharpe (B&S) wire gauges.

Ampacity: See *Current Carrying Capacity*.

Ampere: The unit of current. One ampere is the current flowing through one ohm of resistance at one volt potential.

Analog: A signaling format that uses continuous physical variables such as voltage amplitude or frequency variations to transmit information.

Anneal: Relief of mechanical stress through heat and gradual cooling. Annealing copper renders it less brittle.

Annular Conductor: A number of wires stranded in three reversed concentric layers around a core.

Annunciator: A signaling device, usually electrically operated, that gives an audible or visual signal (or both) when energized.

Anti-Oxidant: A substance which prevents or slows down oxidation of material exposed to air.

Appliance Wire and Cable: A classification covering insulated wire and cable for internal wiring of appliances and equipment.

Arc Resistance: The time required for an arc to establish a conductive path in a material.

Armored Cable: A cable provided with a wrapping of metal for mechanical protection.

Attenuation: The decrease in magnitude of the power of a signal in transmission between points. Attenuation is usually measured in decibels per unit length at a specific frequency.

Attenuation to Crosstalk Ratio (ACR): The difference between attenuation and crosstalk, measured in dB, at a given frequency. Important characteristic in networking transmission to assure that signal sent down a twisted pair is stronger at the receiving end, after being attenuated, than are any interference signals imposed on that same pair by crosstalk from other pairs, represented by NEXT.

Audio Frequency: The range of frequencies audible to the human ear. Usually 20-20,000 Hz.

Backbone: A facility (e.g. pathway, cable or conductors) between telecommunications closets or floor distribution terminals, the entrance facilities and the equipment rooms within or between buildings.

Backbone Cable or Wire: Cable or wire found in the backbone; see *Backbone*.

Balanced Line: A cable having two identical conductors which carry voltages opposite in polarity and equal in magnitude with respect to ground.

Balun: A device for matching an unbalanced coaxial transmission line to a balanced two-wire system.

Band Marking: A continuous circumferential band applied to a conductor at regular intervals for identification.

Banded Cable: Two or more cables banded together by stainless steel strapping.

Bandwidth: A continuous range of frequencies extending between two limiting frequencies. Also referred to as a frequency band.

Barrel-Packed: Method of coiling into a fiber drum for shipment.

Baseband: In data transmission, the use of a dedicated end-to-end connection to carry a single channel only.

Beaded Coax: Coaxial cable with a dielectric consisting of beads made of various materials.

Belt: Number of layers of insulation on a conductor, or number of layers of jacket on a cable.

Belted-Type Cable: Multiple conductor cable having a layer of insulation over the assembled insulated conductors.

Bend Loss: A form of increased attenuation caused by (1) having an optical fiber curved around a restrictive radius of curvature or (2) microbends caused by minute distortions in the fiber imposed by externally induced forces.

Bend Radius: Radius of curvature that a fiber optic or metallic cable can bend without any adverse effects.

Bifilar: A winding made non-inductive by winding together (as one wire) two wires carrying current in opposite directions.

Billion Conductor Feet (BCF): A quantity derived by multiplying the number of conductors in a cable by the amount of cable. Usually used to indicate plant capacity or an annual requirement.

Bimetallic Wire: A wire formed of two different metals joined together (not alloyed). It can include wire with a steel core clad wire, or plated or coated wire.

Binder: A spirally served tape or thread used for holding assembled cable components in place awaiting subsequent manufacturing operations.

Binding Post: A device for clamping or holding electrical conductors in a rigid position.

Bit: One binary (0 or 1) digit.

Blown Jacket: Outer cable covering applied by controlled inflation of the cured jacket tube then pulling the cable through it.

Bond Strength: Amount of adhesion between bonded surfaces, e.g. in cemented ribbon cable.

Bondable Wire: An insulated wire treated to facilitate adherence to materials such as potting compounds. Also, magnet wires used in making coils when bonding the turns together is desired.

Bonded Cable: Cable consisting of pre-insulated conductors or multiconductor components laid-in parallel and bonded into a flat cable. See *Solvent-Bonded*; *Adhesive-Bonded*; *Film-Bonded*.

Bonded Construction: An insulation construction in which the glass braid and nylon jacket are bonded together.

Bonding: The permanent joining of metallic parts to form an electrically conductive path that will assure electrical continuity and the capacity to conduct safely any current likely to be imposed on it.

Booster: A device inserted into a line (or cable) to increase the voltage.

Boot: (1) Protective covering over a cable, wire or connector in addition to the normal jacketing or insulation. (2) A form placed around wire termination of a multiple-contact connector to contain the liquid potting compound before it hardens.

Braid: A fibrous or metallic group of filaments interwoven in cylindrical form to form a covering over one or more wires.

Braid Angle: The smaller of the two angles formed by the shielding strand and in the axis of the cable being shielded.

Braid Carrier: A spool or bobbin on a braid which holds one group of strands or filaments consisting of a specific number of ends. The carrier revolves during braiding operations.

Glossary

Braid Ends: The number of strands used to make up one carrier. The strands are wound side by side on the carrier bobbin and lie parallel in the finished braid.

Braiding Machine: Machine used to apply braids to wire and cable and to produce braided sleeving and braids for tying or lacing purposes. Braiding machines are identified by the number of carriers.

Breakdown (Puncture): A disruptive discharge through the insulation.

Breakdown Voltage: The voltage at which the insulation between two conductors breaks down.

Breakout: The point at which a conductor or group of conductors breaks out from a multiconductor cable to complete circuits at various points along the main cable.

Bridge: A device used to expand a local area network by forwarding frames between data link layers.

Bridged Tap: The multiple appearances of the same cable pair at several distribution points.

British Standard Wire Gauge: A modification of the Birmingham Wire Gauge and the legal standard of Great Britain for all wires. Also known as Standard Wire Gauge (SWG), New British Standard (NBS), English Legal Standard and Imperial Wire Guide.

Broadband: In data transmission, the use of a carrier signal, rather than direct modulation, to carry several simultaneous channels.

Buffer: (fiber optic) A soft material which mechanically isolates individual fibers in a fiber optic cable or bundle from small geometrical irregularities, distortions or roughness of adjacent surfaces.

Buffing Stripper: A motorized device for removing flat cable insulation by means of buffing wheels that melt the insulation and brush it away from the conductors. Also called Abrasion Stripper.

Building Entrance Area: See *Entrance Room or Space, Telecommunications*.

Building Wire: Wire used for light and power, 600 volts or less, usually not exposed to outdoor environment.

Bunched Stranding: A group of strands twisted together in a random manner and the same direction without regard to geometric arrangement of specific strands.

Buncher: A machine that twists wires together in random arrangement.

Bundle: (fiber optic) A number of fibers grouped together, usually carrying a common signal.

Buried Cable: A cable installed directly in the earth without use of underground conduit. Also called "direct burial cable."

Bus: Wire used to connect two terminals inside of an electrical unit.

Bushing: A mechanical device used as a lining for an opening to prevent abrasion to wire and cable.

Butt: Joining of two conductors end-to-end, with no overlap and with the axes in line.

Butt Splice: A splice wherein two wires from opposite ends butt against each other, or against a stop, in the center of a splice.

Butt Wrap: Tape wrapped around an object or conductor in an edge-to-edge condition.

Byte: Typically a group of eight binary digits.

Cable: A stranded conductor with or without insulation and other coverings (single-conductor cable), or a combination of conductors (multiple-conductor cable). In fiber optics, a jacketed fiber or jacketed bundle in a form which can be terminated.

Cable Assembly: Typically, the cable and associated connectors; ready to install.

Cable Clamp: A device used to give mechanical support to the wire bundle or cable at the rear of a plug or receptacle.

Cable Clamp Adapter: A mechanical adapter that attaches to the rear of a plug or receptacle to allow the attachment of a cable clamp.

Cable Core: The portion of an insulated cable lying under a protective covering.

Cable Core Binder: A wrapping of tapes or cords around the conductors of a multiple-conductor cable used to hold them together.

Cable Filler: The material used in multiple-conductor cables to occupy the interslices formed by the assembly of the insulated conductors, thus forming a cable core.

Cable Rack: The vertical or horizontal open support (usually made of aluminum or steel) that is attached to a ceiling or wall.

Cable Sheath: The overall protective covering applied to cables.

Cable Tray: A ladder, trough, solid-bottom or channel raceway system intended for, but not limited to, the support of telecommunications media (e.g., cable).

Cable Vulcanizer: Compression molding machine used to repair cable jacketing that has had a part removed for splicing, for adding connectors or other devices or for replacing damaged sections.

Cabling: (1) A combination of all cables, wire, cords and connecting hardware. (2) Twisting together two or more insulated conductors by machine to form a cable. In fiber optics, a method by which a group or bundle of fibers is mechanically assembled.

Cabling Factor: Used in the formula for calculating the diameter of an unshielded, unjacketed cable. $D = Kd$, where D is the cable diameter, K is the factor and d is the diameter of one insulated conductor.

Campus: The building and grounds of a complex (e.g. a university, college, industrial park or military establishment).

Canadian Standards Association (CSA): A non-profit independent organization which operates a listing service for electrical and electronic materials and equipment. The Canadian counterpart of the Underwriter's Laboratories.

Capacitance: The ratio of the electrostatic charge on a conductor to the potential difference between the conductors required to maintain that charge.

Capacitance, Direct: The capacitance measured from one conductor to another conductor through a single insulating layer.

Capacitance, Mutual: The capacitance between two conductors (typically of a pair) with all other conductors, including shield, short circuited to ground.

Caroprene®: Proprietary rubber compound.

Carrier: The woven element of a braid consisting of one or more ends (strands) which creates the interlaced effect. Also, a spindle, spool, tube, or bobbin (on a braiding machine) containing yarn or wire, employed as a braid.

Cellular Plastics: Expanded or "foam," consists of individual closed cells of inert gas suspended in a plastic medium, resulting in a desirable reduction of the dielectric constant.

Central Office: The place where communications common carriers terminate customer lines and locate switching equipment that interconnects those lines.

Certificate of Compliance (C of C): A written statement; normally generated by a quality control department, which states that the product being shipped meets customer's specifications.

Certified Test Report (CTR): A report reflecting actual test data on the cable shipped. Tests are normally conducted by the quality control department, and show that the product being shipped meets the required test specifications.

Characteristic Impedance: The impedance that, when connected to the output terminals of a transmission line of any length, makes the line appear indefinitely long.

Chlorosulfonated Polyethylene (CSPE): A rubbery polymer used for insulations and jackets. Manufactured by E.I. DuPont under the trade name of Hypalon®.

Cigarette Wrap: Tape insulation wrapped longitudinally instead of spirally over a conductor.

Circuit: A complete path over which electrons can flow from the negative terminals of a voltage source through parts and wires to the positive terminals of the same voltage source.

Circuit Sizes: A popular term for building wire sizes 14 through 10 AWG.

Circular Mil: The area of a circle one mil (.001") in diameter; 7.854×10^{-7} sq. in. Used in expressing wire cross sectional area.

Cladding: Method of applying a layer of metal over another metal whereby the junction of the two metals is continuously welded. In fiber optics, a sheathing intimately in contact with the core of a higher refractive index material which serves to provide optical insulation and protection to the reflection interface.

Closed End Splice: An insulated splice in which two or more wires overlap and enter the splice from the same end of the barrel.

Closet, Telecommunications: An enclosed space for housing telecommunications equipment, cable terminations and cross-connect cabling. The closet is the recognized location of the cross-connect between the backbone and horizontal facilities.

Coaxial Cable: A cable consisting of two cylindrical conductors with a common axis, separated by a dielectric.

Coaxial Connector: A connector that has a coaxial construction and is used with coaxial cable.

Coherent Source: (fiber optic) A light source which emits a very narrow, unidirectional beam of light of one wavelength (monochromatic).

Coil Effect: The inductive effect exhibited by a spiral-wrapped shield, especially above audio frequencies.

Glossary

- Gold Flow:** Permanent deformation of the insulation due to mechanical force of pressure (not due to heat softening).
- Color Code:** A color system for wire or circuit identification by use of solid colors, tracers, braids, surface printing, etc.
- Commercial Building:** A building or portion thereof, that is intended for office use.
- Common Axis Cabling:** In multiple cable constructions, a twisting of all conductors about a "common axis" to result in smaller diameter constructions. Tends to result in greater susceptance to electromagnetic and electrostatic interference.
- Compact Conductor:** Stranded conductor rolled to deform the round wires to fill the normal interstices between the wires in a strand.
- Composite (Clad) Wire:** A wire having a core of one metal with a fused outer shell of different metals.
- Composite Conductor:** Two or more strands of different metals assembled and operated in parallel.
- Compound:** An insulating or jacketing material made by mixing two or more ingredients.
- Compression Cable:** A pipe type cable in which the pressure medium is separated from the insulation by a membrane or sheath.
- Concentric:** A central core surrounded by one or more layers of helically wound strands in a fixed round geometric arrangement.
- Concentric-Lay Cable:** A concentric-lay conductor, or a multiple-conductor cable composed of a central core surrounded by one or more layers of helically laid insulated conductors.
- Concentric Strand:** A strand that consists of a central wire or core surrounded by one or more layers of spirally laid wires.
- Concentricity:** The measurement of the location of the center of the conductor with respect to the geometric center of the circular insulation.
- Conductance:** The ability of a conductor to carry an electric charge. The ratio of the current flow to the potential difference causing the flow. The reciprocal of resistance.
- Conductivity:** The capacity of a material to carry electrical current—usually expressed as a percentage of copper conductivity (copper being 100%).
- Conductor:** A wire (or combination of wires not insulated from one another) suitable for carrying electric current.
- Conduit:** A rigid or flexible metallic or nonmetallic raceway of circular cross-section through which cables can be pulled or housed.
- Connecting Hardware:** A device providing mechanical cable terminations.
- Connector:** A device used to provide rapid connect/disconnect service for electrical cable and wire terminations.
- Contact:** The part of a connector which actually carries the electrical current, and are touched together or separated to control the flow.
- Contact Inspection Hole:** A hole in the cylindrical rear portion of contact used to check the depth to which a wire has been inserted.
- Contact Size:** The largest size wire which can be used with the specific contact. Also, the diameter of the engagement end of the pin.
- Continuity Check:** A test to determine whether electrical current flows continuously throughout the length of a single wire or individual wires in a cable.
- Continuous Vulcanization:** Simultaneous extrusion and vulcanization of rubber-like wire coating materials.
- Contra-helical:** Cable spiralling in an opposite direction than the preceding layer within a wire or cable.
- Control Cable:** A multi-conductor cable made for operation in control of signal circuits.
- Controlled Impedance Cable:** Package of two or more insulated conductors where impedance measurements between respective conductors are kept essentially constant throughout the entire length.
- Copolymer:** A compound resulting from the polymerization of two different monomers.
- Copper-Clad:** Steel with a coating of copper welded to it before drawing as opposed to copper-plated. Synonymous with Copperweld.
- Copperweld:** The trade name of Flexo Wire Division (Copperweld Steel Corp.) for their copper-clad steel conductors.
- Cord:** A small, flexible insulated cable.
- Cord Set:** Portable cords fitted with a wiring device at one or both ends.
- Cord, Telecommunications:** A cable using stranded conductors for flexibility, as in distribution cords or line cords. Line cords can also use tinsel conductors.
- Core:** In cables, a component or assembly of components over which other materials are applied, such as additional components, shield, sheath or armor. In fiber optics, the transparent glass or plastic section with a high refractive index through which the light travels by internal reflections.
- Corona:** A discharge due to ionization of air around a conductor due to a potential gradient exceeding a certain critical value.
- Corona Resistance:** The time that the insulation will withstand a specified level of field-intensified ionization that does not result in the immediate complete breakdown of the insulation.
- Corrosion:** The destruction of the surface of a metal by chemical reaction.
- Coupling Loss:** (fiber optic) Signal losses due to small differences in numerical aperture, core diameter, core concentricity and tolerances in splicing connectors when two fibers are aligned. Also known as Splicing Loss and Transfer Loss.
- Coupling Ring:** A device used on cylindrical connectors to lock plug and receptacle together.
- Coverage:** The calculated percentage which defines the completeness with which a metal braid covers the underlying surface. The higher percentage of coverage, the greater the protection against external interference.
- Covering:** Textile braid or jacket of rubber, plastics or other materials applied over wire and cables to provide mechanical protection and identification.
- Crazing:** The minute cracks on the surface of plastic materials.
- Creep:** The dimensional change with time of a material under load.
- Creepage:** The conduction of electricity across the surface of a dielectric.
- Creepage Path:** The path across the surface of a dielectric between two conductors.
- Creepage Surface:** An insulating surface which provides physical separation as a form of insulation between two electrical conductors of different potential.
- Crimp:** Act of compressing a connector barrel around a cable in order to make an electrical connection.
- Crimp Termination:** Connection in which a metal sleeve is secured to a conductor by mechanically crimping the sleeve with pliers, presses or automated crimping machines.
- Cross-Connect:** A facility enabling the termination of cable elements and their interconnection, and/or cross-connection, primarily by means of a patch cord or jumper.
- Cross-Linked:** Inter-molecular bonds between long-chain thermoplastic polymers by chemical or electron bombardment means. The properties of the resulting thermosetting material are usually improved.
- Crosstalk:** Undesired electrical currents in conductors caused by electromagnetic or electrostatic coupling from other conductors or from external sources. Also, leakage of optical power from one optical conductor to another.
- CSA:** Canadian Standards Association.
- C-SJ:** Same as SJ except extra-flexible conductor.
- C-SJO:** Same as SJO except extra-flexible conductor.
- Cure:** To change the physical properties of a material by chemical reaction.
- Curing Cycle:** The time, temperature and pressure required for curing.
- Curl:** The degree to which a wire tends to form a circle after removal from a spool. An indication of the ability of the wire to be wrapped around posts in long runs.
- Current:** The rate of transfer of electricity. Practical unit is the ampere which represents the transfer of one coulomb per second. In a simple circuit, current (I) produced by a cell or electromotive force (E) when there is an external resistance (R) and internal resistance (r) is:
$$I = \frac{E}{R+r}$$
- Current Carrying Capacity:** The maximum current an insulated conductor can safely carry without exceeding its insulation and jacket temperature limitations.
- Customer Premises:** Building(s) with grounds and appurtenances (belongings) under the control of the customer.
- Cut-Through Resistance:** The ability of a material to withstand mechanical pressure, usually a sharp edge or small radius, without separation.
- Cycle:** The complete sequence including reversal of the flow of an alternating electric current.
- Decibel (dB):** A unit to express differences of power level. Used to express power gain in amplifiers or power loss in passive circuits or cables.
- Delay Line:** A cable made to provide very low velocity of propagation with long electrical delay for transmitted signals.
- Demarcation Point:** A point where the operational control or ownership changes.

Glossary

- Depth of Crimp:** Thickness of the crimped portion of a connector measured between two opposite points on the crimped surface.
- Derating Factor:** A factor used to reduce the current carrying capacity of a wire when used in environments other than that for which the value was established.
- Detector:** (fiber optic) A device that picks up light from fiber and converts the information into an electrical signal.
- Device, As Related to a Work Station:** An item such as a telephone, personal computer or graphic or video terminal.
- Device, As Related to Protection:** A protector, a protector mount, a protector unit or a protector module.
- Dielectric:** An insulating medium which intervenes between two conductors and permits electrostatic attraction and repulsion to take place across it.
- Dielectric Breakdown:** The voltage required to cause an electrical failure or breakthrough of the insulation.
- Dielectric Constant (K):** The ratio of the capacitance of a condenser with dielectric between the electrodes to the capacitance when air is between the electrodes. Also called Permittivity and Specific Inductive Capacity.
- Dielectric Loss:** Power dissipated in an insulating medium as the result of the friction caused by molecular motion when an AC electric field is applied.
- Dielectric Strength:** The voltage which an insulation can withstand before breakdown occurs. Usually expressed as a voltage gradient (such as volts per mil).
- Dielectric Test:** A test in which a voltage higher than the rated voltage is applied for a specified time to determine the adequacy of the insulation under normal conditions.
- Digital:** Transmission data representative by discrete characters.
- Dip Coating:** An insulating coating applied to the conductor by passing the conductor through an applicator containing liquid insulating medium.
- Direct Burial Cable:** A cable installed directly in the earth.
- Direct Capacitance:** The capacitance measured directly from conductor to conductor through a single insulating layer.
- Direct Current (d.c.):** An electric current which flows in only one direction.
- Direct Current Resistance (DCR):** The resistance offered by any circuit to the flow of direct current.
- Direction of Lay:** The lateral direction in which the strands of a conductor run over the top of the cable conductor as they recede from an observer looking along the axis of the conductor or cable. Also applies to twisted cable.
- Discrete Wiring:** Wire or wires having distinct identity and purpose.
- Dispersion:** (fiber optic) The variation of the refractive index of a material with wavelength, causing light of different wavelengths to travel at different velocities in the material.
- Disruptive Discharge:** A sudden, large increase in current through an insulation medium due to the complete failure of the medium under the electrostatic stress.
- Dissipation Factor:** The tangent of the loss angle of the insulating material. (Also referred to as loss tangent, $\tan \delta$, and approximate power factor.)
- Distribution Cable:** In telecommunications and CATV systems, the transmission cable between the distribution amplifier and the drop wire.
- Distribution Frame:** A structure with terminations for connecting the permanent cabling of a facility in such a manner that interconnection or cross-connections may be readily made.
- Disturbed Conductor:** A conductor that receives energy generated by the field of another conductor or an external source such as a transformer.
- Drain Wire:** In a cable, the uninsulated wire laid over the component or components and used as a ground connection.
- Draw Feed Stock:** Rod or wire that is subsequently drawn to a smaller size.
- Drawing:** In wire manufacture, pulling the metal through a die or series of dies to reduce diameter to a specified size.
- Drop Ceiling:** See *False Ceiling*.
- Drop Wire:** In telecommunications and CATV systems, the transmission cable from the distribution cable to a dwelling.
- Dual Coaxial Cable:** Two individually insulated conductors laid parallel or twisted and placed within an overall shield and sheath.
- Duct:** 1) A single enclosed raceway for wires or cables. See also *Conduit, Raceway*; 2) a single enclosed raceway for wires or cables usually used in soil or concrete, 3) an enclosure in which air is moved. Generally part of the HVAC system of a building.
- Duplex:** Two way data transmission on a four-wire transmission line or two fiber.
- Duplex Cable:** (1) A cable composed of two insulated single-conductor cables twisted together. (2) A cable composed of two fibers, typically 62.5/125 μm multimode, placed in parallel under a thermoplastic sheath.
- Duplex Parallel:** Typically used in the thermocouple industry to denote two parallel conductors of dissimilar metals insulated in parallel without twist and jacketed. Commonly applied to thermocouple grades and extension wires.
- Eccentricity:** Like concentricity, a measure of the center of a conductor's location with respect to the circular cross section of the insulation. Expressed as a percentage of displacement of one circle within the other.
- Eddy Current:** Circulating currents induced in conducting materials by varying magnetic fields.
- Elastomer:** A rubber or rubber-like material which will stretch repeatedly to 200 percent or more and return rapidly and with force to its approximate original shape.
- Electro-Tinned:** Electrolytic process of tinning wire using pure tin.
- Electrode:** A conductor through which a current enters or leaves a nonmetallic conductor.
- Electromagnetic Coupling:** Energy transfer by means of a varying magnetic field.
- Electromagnetic Field:** A rapidly moving electric field and its associated moving magnetic field.
- Electromagnetic Induction:** The production of a voltage in a coil due to a change in the number of magnetic lines of forces (flux linkages) passing through the coil.
- Electromagnetic Interference (EMI):** The interference in signal transmission or reception resulting from the radiation of electrical and magnetic fields. Synonym: Radio Frequency Interference.
- Electromotive Force (e.m.f.):** Pressure or voltage. The forces which cause current to flow in a circuit.
- Electronic Wire and Cable:** A length of conductive or semiconductive material used in an electronic application.
- Electrostatic:** Pertaining to static electricity, or electricity at rest. An electric charge, for example.
- Elongation:** The fractional increase in the length of a material stressed in tension.
- Embossing:** A marker identification by means of thermal indentation leaving raised lettering on the sheath material of cable.
- Emergency Overload:** Load which occurs when larger than normal currents are carried through a cable or wire over a certain period of time.
- Enameled Wire:** A conductor with a baked-on enamel film insulation. In addition to magnet wire, enameled insulation is used on thermocouple type wires and other wires.
- Ends:** In braiding, the number of essentially parallel wires of threads on a carrier.
- Energize:** To apply rated voltage to a circuit or device in order to activate it.
- Entrance Facility, Telecommunications:** An entrance to a building for both public and private network service cables (including antennae) including the entrance point at the building wall and continuing to the entrance room or space.
- Entrance Point, Telecommunications:** The point of emergence of telecommunications conductors through an exterior wall, a concrete floor slab or from a rigid metal conduit or intermediate metal conduit.
- Entrance Room or Space, Telecommunications:** A space in which the joining of inter- or intra-building telecommunications backbone facilities takes place. An entrance room may also serve as an equipment room.
- Equilay:** More than one layer of helically laid wires with the direction of lay reversed for successive layers, but with the length of lay the same for each layer.
- Equipment Room, Telecommunications:** A centralized space for telecommunications equipment that serves the occupants of the building. An equipment room is considered distinct from a telecommunications closet because of the nature of complexity or the equipment.
- Etched Wire:** A process applied to fluoroplastic wire in which the wire is passed through a sodium bath to create a rough surface to allow epoxy resin to bond the fluoroplastic.
- Exit Angle:** The angle between the output radiation vectors and the axis of the fiber or fiber bundle.
- External Interference:** The effects of electrical waves or fields which cause sounds other than the desired signal. Static.

Glossary

- External Wiring:** Electronic wiring which interconnects subsystems within the system.
- Extruded Cable:** Cable with conductors which are uniformly insulated and formed by applying a homogeneous insulation material in a continuous extrusion process.
- Extrusion:** Method of continuously forcing plastic, rubber, or elastomer material through an orifice to apply insulation or jacketing over a conductor or cable core.
- False Ceiling:** A ceiling that creates an area or space between the ceiling material and the structure above the material. Synonym: *Drop Ceiling, Suspended Ceiling.*
- Farad:** A unit of electrical capacity.
- Fatigue Resistance:** Resistance to metal crystallization which leads to conductors or wires breaking from flexing.
- Feed-Through Insulators:** Insulators that carry a metal conductor through the chassis while preventing the "hot" lead from shorting to the ground chassis.
- Feedback:** Energy that is extracted from a high-level point in a circuit and applied to a lower level. Positive feedback reduces the stability of a device and is used to increase the sensitivity or produce oscillation in a system. Negative feedback, also called inverse feedback, increases the stability of a system as the feedback improves stability and fidelity.
- Feeder Cable:** In telecommunication or CATV systems, the transmission cable from the head end (signal pickup) to the trunk amplifier. Also called a trunk cable.
- Feedthrough:** (1) A conductor that connects patterns on opposite sides of a PCB. Also called Interfacial connection. (2) A connector or terminal block, usually having double-ended terminals which permit simple distribution and bussing of electrical circuits.
- Ferrous:** Composed of and/or containing iron. A ferrous metal exhibits magnetic characteristics.
- Ferrule:** A short tube used to make solderless connections to shielded or coaxial cable.
- Fiber:** A thread or threadlike structure. Also, a single discrete element used to transmit optical (light wave) information.
- Fiber Dispersion:** (fiber optic) Pulse spreading in a fiber caused by differing transit times of various modes.
- Fiber Optics:** A lightwave or optical communications system in which electrical information is converted to light energy, transmitted to another location through optical fibers, and is there converted back into electrical information.
- Fiber Tubing:** A loose, crush-resistant cylinder applied over individual fibers to provide mechanical protection.
- Field:** An area of influence around a magnet or electric charge.
- Field Coil:** A suitable insulated winding to be mounted on a field pole to magnetize it.
- Figure 8 Cable:** An aerial cable configuration in which the conductors and the steel strand which supports the cable are integrally jacketed. A cross-section of the finished cable approximates the figure "eight."
- Filament:** Fiber characterized by extreme length.
- Filled Cable:** A telephone cable construction in which the cable core is filled with a material that will prevent moisture from entering or passing through the cable.
- Filler:** (1) A material used in multiconductor cables to occupy large interstices formed by the assembled conductors. (2) An inert substance added to a compound to improve properties or decrease cost.
- Film:** A thin plastic sheet.
- Fine Stranded Wire:** Stranded wire with component strands of 36 AWG or smaller.
- Firestop:** A material, device or assembly of parts installed in a cable system in a fire-rated wall or floor to prevent passage of flame, smoke or gasses through the rated barrier.
- Flame Resistance:** The ability of a material not to propagate flame once the heat source is removed.
- Flammability:** The measure of the material's ability to support combustion.
- Flashover:** A disruptive discharge around or over the surface of a solid or liquid insulator.
- Flat Braid:** A woven braid of tinned copper strands rolled flat at time of manufacture to a specified width.
- Flat Cable:** A cable with two smooth or corrugated but essentially flat surfaces.
- Flat Conductor:** A wire having a rectangular cross-section as opposed to a round or square conductor.
- Flat Conductor Cable:** A cable with a plurality of flat conductors.
- Flexfoil®:** Proprietary aluminum laminated shielding tapes.
- Flex Life:** The measurement of the ability of a conductor or cable to withstand repeated bending.
- Flexibility:** The ease with which a cable may be bent.
- Flexible:** That quality of a cable or cable component which allows for bending under the influence of outside force, as opposed to limpness which is bending due to the cable's own weight.
- Floating:** Referring to a circuit which has no connection to ground.
- Flux:** (1) The lines of force which make up an electrostatic field. (2) The rate of flow of energy across or through a surface. (3) A substance used to promote or facilitate fusion.
- FNC:** Federal Networking Council (formerly FRICC).
- Foamed Plastics:** See *Cellular Plastic.*
- Foil:** A thin, continuous sheet of metal.
- Free Connector:** A connector for attachment to the free end of a wire or cable.
- Frequency:** The number of times a periodic action occurs in a unit of time. The number of cycles that an electric current completes in one second.
- Frequency Response:** The characteristic of a device denoting the range of frequencies over which it may be used effectively.
- Funnel Entry:** Flared or widened entrance to a terminal or connector wire barrel.
- Fuse Wire:** Wire made from an alloy that melts at a relatively low temperature.
- Fused Coating:** A metallic coating which has been melted and solidified, forming a metallurgical bond to the base material.
- Fused Conductors:** Individual strands of heavy tinned copper wire stranded together and then bonded together by induction heating.
- Fused Spiral Tape:** A PTFE insulated hookup wire. The spiral wrapped conductor is passed through a sintering oven where overlaps are fused together.
- Gain:** The increase of voltage, current or power over a standard or previous reading. Usually expressed in decibels.
- Galvanometer:** An instrument for detecting or measuring small electrical current.
- Gas-Filled Cable:** A self-contained pressure cable in which the pressure medium is an inert gas having access to the insulation.
- Gauge:** A term used to denote the physical size of a wire.
- Giga:** A numerical prefix denoting one billion (10⁹).
- Gigahertz (GHz):** A unit of frequency equal to one billion hertz.
- Gimmick:** A short length of wire soldered onto a circuit component and used as a small adjustable capacitor.
- Graded-Index:** A type of optical fiber in which the refractive index of the core is in the form of a parabolic curve, decreasing toward the cladding. This type of fiber provides high bandwidth capabilities.
- Ground:** A conducting connection, whether intentional or accidental, between an electrical circuit (e.g. telecommunications) or equipment and the earth, or to some conducting body that serves in place of the earth.
- Ground Conductor:** A conductor in a transmission cable or line that is grounded.
- Ground Insulation:** The insulation used between a winding and the magnetic core or other structural parts, usually at ground potential.
- Ground Loop:** The generation of undesirable current flow within a ground conductor, owing to the circulation currents which originate from a second source of voltage.
- Ground Plane:** Expanded copper mesh which is laminated into some flat cable constructions as a shield.
- Ground Potential:** Zero potential with respect to the ground or earth.
- Hard Drawn Copper Wire:** Copper wire that has not been annealed after drawing.
- Harness:** An arrangement of wires and cables usually with many breakouts, which have been tied together or pulled into a rubber or plastic sheath, used to interconnect an electric circuit.
- Hash Mark Stripe:** A non-continuous helical stripe applied to a conductor for identification.
- Heat Distortion:** Distortion of flow of a material or configuration due to the application of heat.
- Heat Seal:** Method of sealing a tape wrap jacket by means of thermal fusion.
- Heater Cord:** Flexible stranded copper conductor, cotton wrapped, with rubber insulation and asbestos roving.
- Helical Stripe:** A continuous, colored, spiral stripe applied to a conductor for circuit identification.
- Helix:** Spiral winding.
- Henry:** The unit of inductance.
- Hertz (Hz):** A term replacing cycles-per-second as an indication of frequency.
- Heterogeneous Insulation:** A cable insulating system composed of two or more layers of different insulating materials.

Glossary

High-Temperature Wire and Cable: Electrical wire and cables having thermal operating characteristics of 150°C and higher.

High Voltage: Generally, a wire or cable with an operating voltage of over 600 volts.

Holding Strength: Ability of a connector to remain assembled to a cable when under tension.

Homogeneous Insulation: A complete cable insulation structure whose components cannot be identified as layers of different materials.

Hook-up Wire: A wire used for low-current, low-voltage (under 1000 volts) applications within enclosed electronic equipment.

Horizontal Cabling: The wiring/cabling between the telecommunications outlet/connector and the horizontal cross-connect.

Horizontal Cross-Connect: A cross-connect of horizontal cabling to other cabling, e.g. horizontal, backbone or equipment.

Hot Stamping: Method of alpha numerical coding. Identification markings are made by pressing heated type and marking foil into softened insulation surfaces. See Surface Printing.

Hot Tin Dip: A process of passing bare wire through a bath of molten tin to provide a coating.

Hybrid Cable: An assembly of two or more cables (of the same or different types or categories) covered by one overall sheath.

Hygroscopic: Capable of absorbing moisture from the air.

Hypalon®: DuPont's trade name for their chlorosulfonated polyethylene, an ozone-resistant synthetic rubber.

Impact Tool: Device used to punch new conductor onto IDs. This tool is typically equipped with a cutting blade for either 66 or 110 blocks.

Impedance: The total opposition that a circuit offers to the flow of alternating current or any other varying current at a particular frequency. It is a combination of resistance R and reactance X, measured in Ω .

Impedance-Matching Transformer: A transformer designed to match the impedance of one circuit to that of another (BALUN).

Impulse: A surge of unidirectional polarity.

Impulse Strength: The voltage breakdown of insulation under voltage surges on the order of microseconds in duration.

Impulse Test: An insulation test in which the voltage applied is an impulse voltage of specified wave shape.

Incoherent Source: (fiber optic) A light source which emits wide, diffuse beams of light of many wave lengths.

Index-Matching Fluid: (fiber optic) Fluid with refractive index same as fiber core; used to fill air gap between fiber ends at connectors.

Index of Refraction: The ratio of light velocity in a vacuum to its velocity in a given transmitting medium.

Inductance: The property of a circuit or circuit element that opposes a change in current flow, thus causing current changes to lag behind voltage changes. It is measured in henrys.

Inductive Coupling: Crosstalk resulting from the action of the electromagnetic field of one conductor on the other.

Infrastructure, Telecommunications: A collection of those telecommunications components, excluding equipment, that together provide the basic support for the distribution of all information within a building or campus.

Insertion Loss: As measure of the attenuation of a device by determining the output of a system before and after the device is inserted into the system.

Insertion Tool: A small, hand-held tool used to insert contacts into a connector.

Insulated Wire: A conductor of electricity covered with a non-conducting material.

Insulating Joint: A device which mechanically couples and electrically insulates the sheath and armor of contiguous lengths of cable.

Insulation: A material having high resistance to the flow of electric current. Often called a dielectric in radio frequency cable.

Insulation Adhesion: The degree of tightness of the insulation over the base conductor, measured in terms of force required to remove a specified length of insulation from the wire.

Insulation Crimp: The area of a terminal, splice or contact that has been formed around the insulation of the wire.

Insulation Grip: Extended cylinders at the rear of crimp-type contacts designed to accept the bared wire and a small length of its insulation.

Insulation Piercing: A method of crimping whereby lances cut the insulation of the wires and enter into the strands to make electrical contact.

Insulation Resistance: The ratio of the applied voltage to the total current between two electrodes in contact with a specific insulation, usually expressed in meg Ω -M feet.

Insulation System: All of the insulation materials used to insulate a particular electrical or electronic product.

Integral Belt: A layer of insulation or semiconductive material applied by extrusion over two or more insulated, twisted or parallel conductors, to form a round, smooth diameter.

Interconnect: A connection scheme that provides for the direct connection of individual cables to another cable or to an equipment cable without a patch cord.

Interconnecting Cable: The wiring between modules, between units or the larger portions of a system.

Interconnecting Wire: The physical wiring between components (outside a module), between modules, between units or between larger portions of a system or systems.

Interconnection: Mechanically joining devices together to complete an electrical circuit.

Interface: The two surfaces on the contact side of both halves of a multiple-contact connector which face each other when the connector is assembled.

Intermediate Cross-Connect: A cross-connect between 1st level and 2nd level backbone cabling.

Internal Wiring: Electronic wiring which interconnects components, usually within a sealed subsystem.

Interstices: Voids or valleys between individual strands in a conductor or between insulated conductors in a multiconductor cable.

Ionization Voltage (Corona Level): The minimum value of falling rms voltage which sustains electrical discharge within the vacuum or gas-filled spaces in the cable construction or insulation.

Irradiation: In insulations, the exposure of the material to high energy emissions for the purpose of favorably altering the molecular structure.

Jack: A plug-in type terminal widely used in an electronic apparatus for temporary connections.

Jacket: An outer protective sheath over primary insulation, braids, shields, cable components or over the cable itself. In fiber optics, a covering, over a fiber, bundle of fibers or cable which protects against the environment.

JAN Specification: Joint Army-Navy specification (replaced by current Military Specifications).

Jumper: An assembly of twisted pairs without connectors, used to join telecommunications circuits/links at the cross connect.

Junction: A point in a circuit where two or more wires are connected.

Keying: The mechanical feature of a connector system that guarantees correct orientation of a connection, or prevents the connection to a jack, or to an optical fiber adapter of the same type intended for another purpose.

Kynar®: Pennwalt trade name for polyvinylidene fluoride. Typically used as insulation for wire wrap wire.

Lacing and Harnessing: A method of grouping wires by securing them in bundles of designated patterns.

Lacquer: A liquid resin or compound applied to textile braid to prevent fraying, moisture absorption, etc.

Laminated Tape: A tape consisting of two or more layers of different materials bonded together.

Laser Diode: (fiber optic) A semiconductor diode that, when pulsed, a laser diode emits coherent light.

Launch Angle: (fiber optic) The angle between the radiation vector and the axis of the fiber or fiber bundle.

Lay: The length measured along the axis of a wire or cable required for a single strand (in stranded wire) or conductor (in cable) to make one complete turn about the axis of the conductor or cable.

Layer: Consecutive turns of a coil lying in a single plane.

Leaching and Non-Leaching: In a leaching wire, the plasticizer will migrate when exposed to heat. A non-leaching wire will retain its plasticizer under extreme temperature conditions and remain flexible after baking.

Lead: A wire, with or without terminals, that connects two points in a circuit.

Lead-Cured: A cable that is cured or vulcanized in a metallic lead mold.

Lead Dress: The placement or routing of wire and component leads in an electrical circuit.

Lead-in: The conductor or conductors that connect the antenna proper to electronic equipment.

Leakage Current: The undesirable flow of current through or over the surface of an insulation.

Glossary

- Life Cycle:** A test to determine the length of time before failure in a controlled, usually accelerated, environment.
- Light Commercial Building:** A building or portion thereof that is intended for use with one to four (1-4) non-residential exchange access lines per tenant.
- Light-Intensity Ratio:** (fiber optic) Ratio of input light intensity to the output light intensity.
- Light Source:** (fiber optic) An object capable of emitting light. In fiber optics, the light source is normally an LED or a laser.
- Lightguide:** (fiber optic) A flexible bundle of fibers used to transmit light.
- Lightwave Communications:** (fiber optic) Communications using light to carry the information.
- Limits of Error:** The maximum deviation (in degrees of percent) of a thermocouple or thermocouple extension wire from standard emf-temperature to be measured.
- Limpres:** The ability of a cable to lay flat or conform to a surface.
- Line Balance:** The degree to which the conductors of a cable are alike in their electrical characteristics with respect to each other, to other conductors and to ground.
- Line Drop:** A voltage loss occurring between any two points in a transmission line, due to the resonance, reactance or leakage of the line.
- Line Loss:** The total of the various energy losses occurring in a transmission line.
- Line Voltage:** Voltage existing in a cable or circuit.
- Link:** An assembly of telecommunications facilities between two points, not including terminal equipment.
- Listed:** Equipment included in a list published by an organization, acceptable to the authority having jurisdiction, that maintains periodic inspection of production of listed equipment, and whose listing states either that the equipment or material meets appropriate standards or has been tested and found suitable for use in a specified manner.
- Local Area Network (LAN):** A geographically limited communications network intended for the local transport of data, video and voice.
- Longitudinal Shield:** A tape shield, flat or corrugated, applied longitudinally with the axis of the core being shielded.
- Longitudinal Wrap:** Tape applied longitudinally with the axis of the core being covered.
- Loop Resistance:** The total resistance of two conductors measured round-trip from one end. Commonly used term in the thermocouple industry.
- Looping-in:** Wiring method which avoids tee joints by carrying the conductor or cable to and from the point to be supplied.
- Loss:** Energy dissipated without accomplishing useful work.
- Loss Factor:** The product of the dissipation and dielectric constant of an insulating material.
- Lossy Line:** A cable having large attenuation per unit of length.
- Low-Loss Dielectric:** An insulating material that has a relatively low dielectric loss, such as polyethylene or Teflon®.
- Low-Noise Cable:** Cable configuration specially constructed to eliminate spurious electrical disturbances caused by capacitance changes or self-generated noise induced by either physical abuse or adjacent circuitry.
- Low Tension:** Low voltage, as applied to ignition cable.
- Lug:** Termination, usually crimped or soldered to the conductor, with provision for screwing on to the terminal.
- m:** Meter.
- Magnet Wire:** Insulated wire intended for use in windings on motor, transformer and other coils for electromagnetic devices.
- Magnetic Field:** The region within which a body or current experiences magnetic force.
- Magnetic Flux:** The rate of flow of magnetic energy across or through a surface (real or imaginary).
- Magnetic Noise:** Caused by change in current level, e.g. ac powerline (creates magnetic field around the cable) this magnetic field causes the magnetic noise.
- Main Cross-Connect:** A cross-connect for 1st level backbone cables, entrance cables and equipment cables.
- Marker Tape:** A tape laid parallel to the conductors under the sheath in a cable, imprinted with the manufacturer's name and the specification to which the cable is made.
- Master Antenna Television (MATV):** A combination of components providing multiple television receiver operations from one antenna or group of antennas normally on a single building.
- Material Scattering Loss:** (fiber optics) Loss due to fluctuations in the refractive index and to inhomogeneities in material composition and temperature.
- Media, Telecommunications:** Wire, cable or conductors used for telecommunications.
- Megarad:** A unit for measuring radiation dosage.
- Messenger:** Supporting member, usually a high-strength steel wire, used to suspend aerial cable. The messenger may be an integral part of the cable, or exterior to it (lashed messenger).
- Microbending Loss:** (fiber optic) Loss due to small geometrical irregularities along the core-clad interface of the fiber.
- Microfarad:** One-millionth of a farad, commonly abbreviated m-F.
- Micromicrofarad:** One-millionth of a microfarad. (uuf, uufd, mmf, mmmf μ " μ . F are common abbreviations.)
- Microwave:** A short (usually less than 30 cm.) electrical wave.
- Mil:** A unit used in measuring diameter of a wire or thickness of insulation over a conductor. One-one thousandth of an inch (.001").
- Mineral-Insulated:** Cable and thermocouple wire consisting of one or more conductors surrounded by magnesium oxide insulation and enclosed in a liquid- and gas-tight metallic sheathing.
- Miniature Wire:** Insulated conductors of approximately 20-34 AWG.
- Mis-Match:** A termination having a different impedance than that for which a circuit or cable is designed.
- Mode:** One of the components of a general configuration of a propagating wave front.
- Modem:** Device which places and receives data signals over a common carrier's communication facility.
- Modular Jack:** This term is outmoded; see *Outlet/Connector, Telecommunications*.
- Modular Plug:** A telecommunications connector for wire or cords per the Part 68 Rules. A modular plug can have 6 or 8 contact positions, but not all the positions need be equipped with contacts.
- Modulation:** A process whereby certain characteristics of a wave, often called the carrier, are varied or selected in accordance with a modulating function.
- Modulus of Elasticity:** The ratio of stress to strain in an elastic material.
- Moisture Absorption:** The amount of moisture, in percentage, that a material will absorb under specified conditions.
- Moisture Resistance:** The ability of a material to resist absorbing moisture from the air or when immersed in water.
- Molded Plug:** A connector molded on either end of a cord or cable.
- Monomer:** The basic chemical unit used in building a polymer.
- Motor Lead Wire:** Wire which connects to the fragile magnet wire found in coils, transformers and stator or field windings.
- Multiconductor:** More than one conductor within a single cable complex.
- Multimode Optical Fiber:** An optical fiber that will allow many bound modes to propagate. The fiber may be either a graded-index or step-index fiber. See also: *Optical Fiber Cable*.
- Multiple Conductor Cable:** A combination of two or more conductors cabled together and insulated from one another and from sheath or armor where used.
- Multiple Conductor Concentric Cable:** An insulated central conductor with one or more tubular stranded conductors laid over it concentrically and insulated from one another.
- Multiplexing:** Simultaneous transmission of two or more messages over the same cable pair.
- Mutual Capacitance:** Capacitance between two conductors when all other conductors are connected together to shield and ground.
- Mylar®:** DuPont trademark for polyester film.
- Nanometer (nm):** One billionth of a meter (10^{-9} meter).
- Nanosecond:** One billionth of a second (10^{-9} seconds).
- National Electric Code (NEC):** A set of regulations governing construction and installation of electrical wiring and apparatus in the United States, established by the American National Board of Fire Underwriters.
- Neoprene:** A synthetic rubber with good resistance to oil, chemical and flame. Also called polychloroprene.
- Noise:** In a cable or circuit, any extraneous signal which tends to interfere with the signal normally present in or passing through the system.
- Nomex®:** DuPont trademark for a temperature-resistant, flame-retardant nylon.
- Non-Contaminating:** Type of PVC jacket material whose plasticizer will not migrate into the dielectric of a coaxial cable and thus avoids contaminating and destroying the dielectric.

Glossary

Nylon: Thermoplastic with good chemical and abrasion resistance.

NVP: Nominal Velocity of Propagation.

Off Center: Conductor displaced within the cross-section of its insulation.

Offgassing: Percentage of a specified gas released during the combustion of insulation or jacketing material.

Ohm: A unit of electrical resistance.

Oil Aging: Cable aged in an accelerated manner by placement in an oil bath and heated to a pre-set temperature for a stated time.

Oil-Filled Cable: A self-contained pressure cable in which the pressure medium is low viscosity oil having access to the insulation.

Opaque: (fiber optic) Not permitting the passage of light.

Open Cell: Foamed or cellular material with cells which are generally interconnected.

Optical Communication Cable: (fiber optic) Fiber with a protective jacket around it.

Optical Conductors: (fiber optic) Materials which offer a low optical attenuation to transmission of light energy.

Optical Fiber Cable: An assembly consisting of one or more optical fibers.

Optical Fiber Duplex Adapter: A mechanical media termination device designed to align and join two duplex connectors.

Optical Fiber Duplex Connector: A mechanical media termination device designed to transfer optical power between two pairs of optical fibers.

Optical Waveguide: (fiber optic) A fiber used for optical communications. Analogous to a waveguide used for microwave communications.

Oscillatory Surge: A surge which includes both positive and negative polarity values.

Outgassing: The dissipation of gas from a dielectric evidencing decomposition.

Outlet Box, Telecommunications: A metallic or nonmetallic box mounted within a wall, floor or ceiling and used to hold telecommunications outlet/connectors or transition devices.

Outlet/Connector, Telecommunications: A connecting device in the work area on which horizontal cable terminates.

Overall Diameter: Finished diameter over wire or cable.

Overcoat Conductor: A stranded conductor made from individual strands of tin-coated wire stranded together, and then given an overall tin coat.

Overlap: The amount the trailing edge laps over the leading edge of a spiral tape wrap.

Oxygen Index: Percentage of oxygen necessary to support combustion in a gas mixture.

Ozone: Reactive form of oxygen, typically found around electrical discharges and present in the atmosphere in small quantities.

Packing Fraction: (fiber optic) The ratio of active cross-sectional area of fiber core, or cores, to the total end surface of the fiber, or fiber bundle.

Pair: Two insulated wires of a single circuit associated together, also known as a "balance" transmission line.

Parallel Pair: A duplex construction of two insulated conductors laid parallel and then covered overall with a braid or jacket.

Parallel Stripe: A stripe applied longitudinally on a wire or cable parallel to the axis of the conductor.

Patch Cord: A length of cable with connectors on one or both ends used to join telecommunications links/circuits at the cross-connect.

Patch Cord Cable: Bulk cable used in the manufacture of patch cords.

Patch Panel: A cross-connect system of mateable connectors that facilitates administration.

Pathway: A facility for the placement of telecommunications cable. Synonym: *Raceway*.

Pay-Off: The process of feeding a cable or wire from a bobbin, reel or other package.

Percent Plating: Quantity of plating on a conductor expressed as a percentage by weight.

Percentage Conductivity: Conductivity of a material expressed as a percentage of that of copper.

Periodicity: The uniformly spaced variations in the insulation diameter of a transmission cable that result in reflections of a signal, when its wavelength or a multiple thereof is equal to the distance between two diameter variations.

Permittivity: See *Dielectric Constant*.

Phase: An angular relationship between waves.

Phase Shift: A change in the phase relationship between two alternating quantities.

Photodetector (Receiver): Converts light energy to electrical energy.

Pick: Distance between two adjacent crossover points of braid filaments. The measurement in picks per inch indicates the degree of coverage.

Picofarad: One-millionth of one-millionth of a farad. A micromicrofarad or picofarad (abbreviation pf). (See $\mu\mu F$).

Pigtail Wire: Fine-stranded, extra-flexible, rope-lay lead wire attached to a shield for terminating purposes.

Pitch: In flat cable, the nominal distance between the index edges of two adjacent conductors.

Pitch Diameter: Diameter of a circle passing through the center of the conductors in any layer of a multiconductor cable.

Plain Conductor: A conductor consisting of only one metal.

Plain Weave: A weave used on woven cables. Threads between the wires act as binders and give the cable lateral stiffness and linear flexibility. Also called Standard and Square Weave.

Planetary Cabler: A cabler capable of laying down any number of shielded, overbraided or jacketed singles, pairs, called groups, or any combination of them in sequence.

Planetary Twister: A twisting machine whose payoff spools are mounted in rotating cradles that hold the axis of the spool in a fixed direction as the spools are revolved so no twist is built up in each wire.

Plastic Deformation: Change in dimensions under load that is not recovered when the load is removed.

Plasticizer: A chemical agent added to plastics to make them softer and more pliable.

Plenum: The air return path of a central air handling system, either ductwork or open space over a suspended ceiling.

Plenum Cable: Cable approved by a recognized agency such as UL for installation in plenums without the need for conduit.

Plug: The part of the two mating halves of a connector which is moveable when not fastened to the other mating half.

Ply: The number of individual strands or filaments twisted together to form a single thread.

Point-to-Point: A type of connection established between two specific locations, as between two buildings.

Point-to-Point Wiring: An interconnecting technique wherein the connections between components are made by wires routed between connecting points.

Polarization: The orientation of a flat cable or a rectangular connector.

Polishing: (fiber optic) Act of smoothing ends of fibers to an 'optically smooth' finish, generally using abrasive.

Polyester: Polyethylene terephthalate, used extensively as a moisture-resistant cable core wrap.

Polyethylene: A thermoplastic material having excellent electrical properties.

Polyhalocarbon: A general name for polymers containing halogen atoms. The halogens are fluorine, chlorine, bromine and iodine.

Polymer: A material of high molecular weight formed by the chemical union of monomers.

Polyolefin: Any of the polymers and copolymers of the ethylene family of hydrocarbons.

Polypropylene: A thermoplastic similar to polyethylene but stiffer and having higher softening point (temperature); excellent electrical properties.

Polyurethane: Class of polymers known for good abrasion and solvent resistance (may be applied in solid or cellular form).

Porosity: Multiple voids in an insulation cross-section.

Potting: The sealing of a cable termination or other component with a liquid which thermosets into an elastomer.

Power Cables: Cables of various sizes, construction and insulation, single or multi-conductor designed to distribute primary power to various types of equipment.

Power Factor: The ratio of resistance to impedance. The ratio of the actual power of an alternating current to apparent power. Mathematically, the cosine of the angle between the voltage applied and the current resulting.

Pre-Bond: Stranded wire which has been fused, topcoat-tinned or overcoat-tinned.

Prewiring: Wiring installed

- Before walls are enclosed or finished.
- In anticipation of future use or need.

Primary: The transformer winding which receives the energy from a supply circuit.

Primary Insulation: The first layer of non-conductive material applied over a conductor, whose prime function is to act as electrical insulation.

Primary Protection: The minimum protection required on all exposed facilities to comply with NEC requirements.

Primary Wiring: A printed circuit intended to provide point-to-point electrical connections.

Programming: Ability to select various circuit patterns by interconnecting appropriate contacts on one side of a connector plug or panel.

Propagation Delay: Time delay between input and output of signal.

Glossary

Propagation Time: Time required for a wave to travel between two points on a transmission line.

Protocol: A set of rules for communicating.

Proximity Effect: Nonuniform current distribution over the cross-section of a conductor caused by the variation of the current in a neighboring conductor.

Pull Box: A device to access a raceway used to facilitate placing of wire or cables.

Pull Cord/Pull Wire: Cord or wire placed within a raceway and used to pull wire and cable through the raceway.

Pull Strength: See *Pull Tension*.

Pull Tension: The maximum pulling force that can be safely applied to a cable without damage.

Pulling Eye: A device used to pull cable into or from a duct.

Pulse: Energy which changes abruptly from an intensity to another. May be light energy or electrical energy.

Pulse Cable: A type of coaxial cable constructed to transmit repeated high-voltage pulses without degradation.

Polyvinyl Chloride (PVC): A general-purpose thermoplastic widely used for wire and cable insulations and jackets.

Quad: A series of four separately insulated conductors, generally twisted together in pairs. Also, a series-parallel combination of transistors with increased reliability because failure of one transistor will not disable the entire circuit.

Quadders: Three-bay machines which can twist four wires together and cable braided and shielded wires with varying lay lengths.

Raceway: Any channel designed for holding wires or cables, e.g. conduit, electrical metallic tubing, sleeves, slots, underfloor raceways, cellular floors, surface raceways, lighting fixture raceways, wireways, cable troughs, busways, auxiliary gutters and ventilated flexible cableways. Synonym: *Pathway*.

Rack: See: *Cable Rack*.

Radio Frequency: The frequencies in the electromagnetic spectrum that are used for radio communications.

Random Winding: A winding in rotating equipment wherein the wires do not lie in an even pattern.

Reactance: The opposition offered to the flow of alternating current by inductance or capacitance of a compound or circuit.

Red Plaque: A powdery, brown-red growth found on silver-coated copper conductors and shield braids.

Redraw: The consecutive drawing of wire through a series of dies to reach a desired wire size.

Reducing Joint: A joint between two lengths of cable where the conductors are not the same size.

Reel: A revolvable flanged device made of wood or metal, used for winding flexible metal wire or cable.

Reflection: (fiber optic) Change in direction of a light wave or ray.

Reflection Loss: The part of a signal which is lost due to reflection of power at a line discontinuity.

Refraction: (fiber optic) The bending of lightwaves or rays as they go from one material to another due to the difference in velocities in the materials.

Reinforced Sheath: The outermost covering of a cable that has cable sheath constructed in layers with the addition of a reinforcing material, usually a braided fiber, molded in place between layers.

Remanence: The magnetic induction that remains in a magnetic circuit after the removal of an applied magnetomotive force.

Repeater: A device which consists of a transmitter and a receiver or transmitter, used to regenerate a signal to increase the system transmission length.

Resistance: A measure of the difficulty in moving electrical current through a medium when voltage is applied. It is measured in Ω .

Resistive Conductor: A conductor with high electric resistance.

Retractile Cord: A cord having specially treated insulation or jacket so that it will retract.

Return Wire: A ground wire or the negative wire in a direct-current circuit.

Ribbon Cable: A flat cable of individually insulated conductors lying parallel and held together by means of adhesive or woven textile yarn.

Ridge Marker: One or more ridges running laterally along the outer surface of a plastic-insulated wire for purposes of identification.

Rigid Bay: Cabling equipment that maintains component sequence, and can produce cables with distinct layers.

Rigid Coaxial Cable: Nonflexible coaxial cable, usually a metal tube armored coaxial cable.

Ring Tongue: A solderless terminal that connects wire to a stud.

Ringing Out: Locating or identifying specific conductive paths by passing current through selected conductors.

Rip-Cord: 1.) Two or more insulated conductors in a parallel configuration which may be separated to leave the insulation of each conductor intact. 2.) A small filament cord used to rip through the outer cable sheath.

RoHS (Restriction on Hazardous Substances): European Union directive that restricts use of heavy metal substances.

Rope Concentric: A group of standard conductors assembled in a concentric manner.

Rope Lay Conductor: A conductor composed of a central core surrounded by one or more layers of helically laid groups of wires.

Rope Unilay: A group of stranded conductors assembled in a unilay manner.

Round Wire Shields: Shields constructed from bare, tinned or silver-plated copper wire that include braided, spiral and reverse spiral.

Routers: A device that determines how to forward a packet toward its destination, based on tables that indicate the costs, congestion status and other factors associated with possible routes. Also called a level 3 relay or an intermediate system.

Rubber (Wire Insulation): Term used to describe wire insulations made of thermosetting elastomers; occurs naturally or may be made synthetically.

Rulan®: DuPont's trade name for their flame-retardant polyethylene insulating material.

Screen: A shield placed over the entire core.

Secondary Insulation: A nonconductive material that protects the conductor against abrasion and provides a second electrical barrier.

Segmental Conductor: A stranded conductor consisting of three or more stranded conducting elements, each element having approximately the shape of the sector of a circle, assembled to give a substantially circular cross-section.

Selenium Cure: Process used to cure neoprene and rubber jacketed wires and cables.

Self-Extinguishing: Characteristic of a material whose flame is extinguished after the igniting flame source is removed.

Semi-Conducting Jacket: A jacket having a sufficiently low resistance so that its outer surface can be kept at substantially ground potential.

Semi-Rigid: A cable containing a flexible inner core and a relatively inflexible sheathing.

Semi-Solid: An insulation cross-section having a partially open space between the conductor and the insulation perimeter.

Separator: A layer of insulating material which is placed between a conductor and its dielectric between a cable jacket and the components it covers, or between various components of a multiple-conductor cable.

Series Circuit: A circuit in which the components are arranged end to end to form a single path for current.

Serve: A filament or group of filaments such as fibers or wires, wound around a central core.

Servicing: A wrapping applied over the core of a cable or over a wire.

Sheath: See *Cable Sheath*.

Shield: In cables, a metallic layer placed around a conductor or group of conductors to prevent electrostatic or electromagnetic interference between the enclosed wires or external fields.

Shield Coverage: Amount of outer cable covered by the shielding material.

Shield Effectiveness: The ability of a shield to screen out undesirable signals.

Shielded Line: A transmission line whose elements confine propagated radio waves to an essentially finite space inside a tubular conducting surface called the sheath, thus preventing the line from radiating radio waves.

Shielded-Type Cable: A cable in which the surface of the insulation is at ground potential.

Shunt Wire: A conductor joining two parts of an electric circuit to divert part of the current.

Signal: A current used to convey information, either digital, analog, audio or video.

Silicone: A material made from silicon and oxygen. Can be in thermosetting elastomer or liquid form. The thermosetting elastomer form is noted for high heat resistance.

Silicone Treating: A silicone liquid treatment applied to insulated conductors to allow for easy jacket stripping.

Sine Wave: A wave that can be expressed as the sine of a linear function of time, or space or both.

Single-ended: Unbalanced, such as grounding one side of a circuit or transmission line.

Single-Faced Tape: Fabric tape finished on one side with a rubber or synthetic compound.

Singlemode Fiber: A fiber wave guide in which only one mode will propagate. The fiber has a very small core diameter of approximately 8mm. It permits signal transmission at extremely high bandwidths and is generally used with laser diodes.

Glossary

Sizing: Applying a material to a surface to fill pores.

Skeleton Braid: Widely separated braid of fiber copper or steel, used to hold core together, for reinforcing jacket or for shielding.

Skew Rays: A ray that does not intersect the fiber axis. Generally, a light ray that enters the fiber core at a very high angle.

Skim Tape: Filled tape coated on one or both sides with a thin film of uncured rubber or synthetic compound to produce a coating suitable for vulcanization.

Skin Effect: The tendency of alternating current, as its frequency increases, to travel only on the surface of a conductor.

Sleeve: A braided, knitted or woven tube used over wires or components as insulation tubing. Also called *Sleeving*.

Solid Conductor: A conductor consisting of a single wire.

Source Coupling Loss: (fiber optic) Loss of light intensity as light from source passes into fiber.

Space, Telecommunications: An area used for housing the installation and termination of telecommunications equipment and cable, e.g. telecommunications closets, work areas and manhole/handholes.

Span: (1.) In flat conductors, distance between the reference edge of the first and the last conductor. (2.) In round conductors, distance between centers of the first and last conductors. (3.) In aerial cable, the distance between poles or support clamps.

Spark Test: A test designed to locate pin-holes in the insulation of a wire or cable by application of a voltage for a very short period of time while the wire is being drawn through the electrode field.

Specific Gravity: The ratio of the density (mass per unit volume) of a material to that of water.

Spectral Bandwidth: The difference between wavelengths at which the radiant intensity of illumination is half its peak intensity.

Spectral Response: (fiber optic) The response of a detector (or a system) over different wavelengths.

Spectrum: Frequencies that exist in a continuous range and have a common characteristic.

Speed of Light (c): 2.998×10^8 meters per second.

Spiral Shield: A metallic shield of fine-stranded wires applied spirally rather than braided.

Spiral Stripe: A color-coding stripe applied helically to the surface of an insulated wire or cable.

Spiral Wrap: The helical wrap of a tape or thread over a core.

Splice: A joining of conductors, generally from separate sheaths.

Splice Closure: A device used to protect a cable or wire splice.

Spread Spectrum: A modulation technique for multiple access, or for increasing immunity to noise and interference.

Standing Wave: The stationary pattern of waves produced by two waves of the same frequency traveling in opposite directions on the same transmission line.

Standing Wave Ratio (SWR): In a transmission line, waveguide, or analogous system, a figure of merit used to express the efficiency of the system in transmitting power.

Star Topology: A topology in which each telecommunications outlet/connector is directly cabled to the distribution device.

Stay Cord: A component of a cable used to anchor the cable ends at their points of termination and to keep any pull of the cable from being transferred to the electrical connections.

Step Index Fiber: (fiber optic) A multimode fiber consisting of a core of uniform refractive index surrounded by cladding of slightly lower refractive index.

Strand: One of the wires of any stranded conductor.

Strand Lay: The distance of advance of one strand of a spirally stranded conductor, in one turn, measured axially.

Stranded Conductor: A conductor composed of groups of wires twisted together.

Strap: Square- or rectangular-section bare conductor manufactured and used in coil form.

Strip: To remove insulation from a cable.

Structural Return Loss: Backward reflected energies from uneven parts of the cable structure causing impedance variations are termed structural return loss.

Surface Resistivity: The resistance of a material between two opposite sides of a unit square of its surface. It is usually expressed in Ω .

Surge: A temporary and relatively large increase in the voltage or current in an electric circuit or cable. Also called *Transient*.

Suspended Ceiling: See *False Ceiling*.

Sweep-test: Pertaining to cable, the frequency response is verified by generating an rf voltage whose frequency is swept repeatedly through a given frequency range at a rapid constant rate while the cable response is observed.

Take-Up: The process of accumulating wire or cable onto a reel, bobbin or some other type of pack. Also, the device for pulling wire or cable through a piece of equipment or machine.

Tank Test: A voltage dielectric test in which the test sample is submerged in water and voltage is applied between the conductor and water as ground.

Tape: A relatively narrow woven or cut strip of fabric, paper or film material.

Tape Cable: A form of multiple conductor consisting of parallel metal strips imbedded in insulating material.

Tape Wrap: A spirally applied tape over an insulated or uninsulated wire.

Taped Insulation: Insulation of helically wound tapes applied over a conductor or over an assembled group of insulated conductors.

Taping: Process of insulating continuous length, large diameter wires with tape of non-extrudable materials.

TB: Terminal Block

Tear Strength: The force required to initiate or continue a tear in a material under specified conditions.

Teflon®: DuPont company trade name for fluorocarbon resins. FEP, PFA and TFE are typical materials.

Tefzel®: DuPont trade name for a fluorocarbon material typically used as a wire wrap insulation.

Telecommunications: The communication of information over some distance, including interbuilding and intrabuilding distances.

Telecommunications Closet: See *Closet, Telecommunications*.

Telecommunications Entrance Facility: See *Entrance Facility, Telecommunications*.

Telecommunications Entrance Point: See *Entrance Point, Telecommunications*.

Telecommunications Entrance Room or Space: See *Entrance Room or Space, Telecommunications*.

Telecommunications Equipment Room: See *Equipment Room, Telecommunications*.

Telecommunications Grounding Busbar: A common point of connection for telecommunications system and bonding to ground, which is located in the telecommunications closet or equipment room.

Telecommunications Infrastructure: See *Infrastructure, Telecommunications*.

Telecommunications Outlet/Connector: See *Outlet/Connector, Telecommunications*.

Telemetry Cable: Cable used for transmission of information from instruments to the peripheral recording equipment.

Temperature Rating: The maximum temperature at which an insulating material may be used in continuous operation without loss of its basic properties.

Tensile Strength: The pull stress required to break a given specimen.

Tension Member: A member included in a fiber cable to add tensile strength.

Terminal: (1) A point at which information may enter or leave a communications network; (2) the input-output associated equipment; or (3) a device by means of which wires may be connected to each other.

Termination Hardware: This term is outmoded. See *Connecting Hardware*.

Test Lead: A flexible, insulated lead wire used for making tests, connecting instruments to a circuit temporarily or for making temporary electrical connections.

Textile Braid: Any braid made from threads of cotton silk, or synthetic fibers.

Thermal Aging: Exposure to a thermal condition or programmed series of conditions for prescribed periods of time.

Thermocouple Lead Wire: An insulated pair of wires used from the couple to a junction box.

Thermoplastic: A material which softens when heated and becomes firm on cooling.

Thermoset: A material which hardens or sets when heat is applied, and which, once set, cannot be resoftened by heating. The application of heat is called "curing."

Three-Phase Current: Current delivered through three wires, with each wire serving as a return for the other two.

Three-Phase Three-Wire System: An alternating current supply system comprising three conductors over which three-phase power is sent.

Three-Wire System: A d-c or single-phase a-c system comprising three conductors, one of which is maintained at a potential midway between the potential of the other two.

Tin Overcoat (TOC): Tinned copper wire, stranded, then coated with pure tin.

Glossary

Tinsel Wire: A low-voltage stranded wire, with each strand a very thin conductor ribbon spirally wrapped around a textile yarn.

Topcoat: Bare (untinned) copper wire, stranded then coated with pure tin.

Topology: The physical or logical arrangement of a telecommunications system.

Tracer: A means of identifying polarity.

Transducer: A device for converting mechanical energy to electrical energy.

Transfer Impedance: The ratio of the source voltage of the wires inside the cable to the shield current of the cable or connectorized cable assembly.

Transition Point: A location in the horizontal cabling where flat undercarpet cable connects to round cable.

Transmission: Transfer of electric energy from one location to another through conductors or by radiation or induction fields.

Transmission Cable: Two or more transmission lines. See *Transmission Line*.

Transmission Line: An arrangement of two or more conductors or a wave guide used to transfer signal energy from one location to another.

Transmission Loss: The decrease or loss in power during transmission of energy from one point to another. Usually expressed in decibels.

Transmission Media: The various types of wire and optical fiber cable used for transmitting voice or data signals. Typically, wire cable includes twisted pair, coaxial and twinaxial. Optical fiber cable includes single, dual, quad, stranded and ribbon (AI).

Transmitter: The electronic package that injects an electrical signal or light signal over the transmission medium.

Transparent: (fiber optic) Transmitting rays of light so that objects can be seen through the material.

Transposition: Interchanging the relative positions of wires to neutralize the effects of induction to or from other circuits or, to minimize interference pickup by the lead-in during reception.

Tray Cable: A factory-assembled multiconductor or multipair control cable approved under the National Electrical Code for installation in trays.

Triaxial: A three-conductor cable with one conductor in the center, a second circular conductor shield concentric with the first, and third circular conductor shield insulated from and concentric with the first and second, usually with insulation, and over a braid or impervious sheath overall.

Triboelectric Noise: Noise generated in a shielded cable due to variations in capacitance between shielding and conductor as the cable is flexed.

Triple Cable: A cable composed of three insulated single conductors and one bare conductor, all twisted together. It may or may not have a common covering of binding.

True Concentric: A cable in which each successive layer has a reversed direction of lay from the preceding layer.

Trunk Cable: See *Feeder Cable*.

Tubing: A tube of extruded non-supported plastic material.

Twin Cable: A pair of insulated conductors twisted, sheathed or held together mechanically and not identifiable from each other in a common covering.

Twin Coaxial: A configuration containing two separate, complete coaxial cables laid parallel or twisted around each other in one complex.

Twin Line: A transmission line which has a solid insulating material, in which the two conductors are placed in parallel to each other.

Twinner: A device for twisting together two conductors.

Twisted Pairs: A cable composed of two small insulated conductors twisted together without a common covering.

Unbalanced Line: A transmission line in which voltages on the two conductors are unequal with respect to ground.

Unidirectional Concentric Stranding: A stranding where each successive layer has a different lay length, thereby retaining a circular form without migration of strands from one layer to another.

Unidirectional Stranding: A term denoting that in a stranded conductor, all layers have the same direction of lay.

Unilay Strand: A conductor constructed with a central core surrounded by more than one layer of helically-laid wires, with all layers having a common length and direction of lay.

Velocity of Propagation (VP): The speed of an electrical signal down a length of cable compared to speed in free space expressed as a percent. It is the reciprocal of the square root of the dielectric constant of the cable insulation.

Volt: A unit of electromotive force.

Voltage: The term most often used in place of electromotive force, potential difference or voltage drop to designate the electric pressure that exists between two points and is capable of producing a current when a closed circuit is connected between two points.

Voltage Drop: The voltage developed across a component or conductor by the current in the resistance or impedance of the component or conductor.

Voltage Rating: The highest voltage that may be continuously applied to a wire in conformance with standards or specifications.

Voltage Standing Wave Ratio (VSWR): The ratio of the maximum effective voltage to the minimum effective voltage measured along the length of a mis-matched radio frequency transmission line.

Volume Resistivity (Specific Insulation Resistance): The electrical resistance between opposite faces of a 1 cm. cube of insulating material, commonly expressed in Ω /centimeter.

Vulcanization: A chemical reaction in which the physical properties of an elastomer are changed by reacting it with sulfur or other cross-linking agents.

Wall Thickness: The thickness of the applied insulation or jacket.

Water Absorption: A test to determine the water absorbed by a material after a given immersion period.

Waterblocked Cable: A cable constructed with no internal voids in order to allow no longitudinal water passage under a given pressure.

Watt: A unit of electric power.

Wave Form: A graphical representation of a varying quantity. Usually, time is represented on the horizontal axis, and the current or voltage value is represented on the vertical axis.

Wave Length: The distance, measured in the direction of propagation, of a repetitive electrical pulse or waveform between two successive points that are characterized by the same phase of vibration.

Wicking: The longitudinal flow of a liquid in a wire or cable due to capillary action.

Wire: A conductor, either bare or insulated.

Wire and Cable Marker: Device for identification marking of wire and cable.

Wire and Cable Tying, Clamping, and Harnessing Devices: Tying tapes, lacing cords and flexible sleeveings which are used for wire and cable bundling, harnessing and holding. Other devices include plastic ties or clamps, spiral-cut plastic tubing and plastic U-shaped trays or ducts.

Wire and Lead Cutters: Tools for cutting that range from plier-type cutters to semiautomatic or fully automatic machines integrated with other wire processing operations such as stripping, forming and terminating.

Wire Gauge: A system of numerical designation of wire sizes.

Wire Nut: A closed-end splice that is screwed on instead of crimped.

Wire Wrapped Connection: A solderless connection made by wrapping bare wire around a square or rectangular terminal with a power or hand tool.

Wire Wrapping Tools: Portable electric tools and automatic stationary machines used to make solderless wrapped connections of wires to terminals.

Wiring Closet: See *Telecommunications Closet*.

Work Area (Work Station): A building space where the occupants interact with telecommunications terminal equipment.

Wrapper: An insulating barrier applied as a sheet or tape wrapped around a coil periphery.

Yield Strength: The minimum stress at which a material will start to physically deform without increase in load.

Zytel®: DuPont's trade name for nylon resins.

Sections of this glossary are reprinted with permission from December, 1985 Issue of ELECTRONICS copyright 1985. Lake Publishing Corporation, 17730 W. Peterson Rd., Libertyville, IL 60048-0159 USA. Permission to reprint granted to the General Cable Corporation. No additional reproduction of this wire and cable glossary allowed without written permission.

Abbreviations & Acronyms

A-D: Analog to digital conversion	CEN: European Committee for Standardization	E: Symbol for voltage. Usually used to represent direct voltage or the effective (root-mean-square) value of an alternating voltage
ac: Alternating current	CENELEC: European Committee for Electrotechnical Standardization	EFTS: Electronic funds transfer system
AC: Armored Cable, NEC Article 333 Cable Designation	CFC: Communications Flat Cable	EIA: Electronic Industries Association
ACO: Analog Central Office	ckt: Circuit	EMF: Electromotive Force
ACR: Attenuation to Crosstalk Ratio	CLT or CLOS: Closet	EMI: Electromagnetic Interference
ADO: Auxiliary Disconnect Outlet	CL2: Class 2 Circuit Cable, NEC Article 725 Cable Designation	EMT: Electric Metallic Tubing
AER: Aerial	CL2P: Class 2 Circuit Plenum Cable, NEC Article 725 Cable Designation	EP: Entrance point
AF: Audio frequency	CL2R: Class 2 Circuit Riser Cable, NEC Article 725 Cable Designation	EPDM: Ethylene-propylene-diene monomer rubber
AIA: American Institute of Architects	CL2X: Class 2 Circuit Limited Use Cable, NEC Article 725 Cable Designation	EPOS: Electronic Point-Of-Sale
ALPETH: An aerial telephone cable having an aluminum shield and polyethylene jacket	CL3: Class 3 Circuit Cable, NEC Article 725 Cable Designation	EPR: Ethylene-propylene rubber
ALS: A type of cable consisting of insulated conductors enclosed in a continuous, closely fitting aluminum tube	CL3P: Class 3 Circuit Plenum Cable, NEC Article 725 Cable Designation	ER: Equipment room
ALVYN: An indoor, riser rated telephone cable having an aluminum shield and vinyl jacket (PVC)	CL3R: Class 3 Circuit Riser Cable, NEC Article 725 Cable Designation	ESS: Electronic Switching System
AM: Amplitude Modulation	CL3X: Class 3 Circuit Limited Use Cable, NEC Article 725 Cable Designation	ESTA: Australian approval agency; Electricity Trust of South Australia
ANSI: American National Standards Institute	CM: Communications Cable, NEC Article 800 Cable Designation	ETPC: Electrolytic Tough Pitch Copper
ARPANET: Advanced Research Projects Agency Network	CMA: Circular Mil Area	ETV: Educational Television
ASCII: American Standard Code for Information Interchange	CMP: Communication Cable Plenum, NEC Article 800 Cable Designation	E/W: Equipped With
ASME: American Society of Mechanical Engineers	CMR: Communications Cable Riser, NEC Article 800 Cable Designation	EX or EXT: Extension
ASP: A filled, direct burial telephone cable used in areas subject to rodent attack. It consists of a filled cable core, corrugated aluminum shield, corrugated steel tape, flooding compound and polyethylene jacket.	CMX: Communications Limited Use Cable, NEC Article 800 Cable Designation	EXCH: Exchange
ASTA: United Kingdom approval agency	CO: Central Office	f: Frequency
ASTM: American Society for Testing and Materials	codec: Coder decoder	FAA: Federal Aeronautics Administration
AWG: American Wire Gauge	COE: Central Office Equipment	FCC: (1) Federal Communications Commission (2) Flat Conductor Cable, NEC Article 328 Cable Designation
AWM: Appliance wiring material	COS: Cooperation for Open Systems	FDDI: Fiber Distributed Data Interface
B & S Gauge: See American Wire Gauge (AWG)	COSINE: Cooperation for Open Systems Interconnection Network in Europe	FDI: Frequency-Division Multiplexing
B or BUR: Buried	COT: Central Office Terminal	FDR: Feeder
AWM: Appliance wiring material	CPC: Customer Premises Communication	FEP: Fluorinated ethylene propylene
BCF: Billion Conductor Feet	CPE: (1) Chlorinated Polyethylene (2) Customer Premises Equipment or Customer Provided Equipment	FEXT: Far End Crosstalk
BEF: Building Entrance Facility	CPU: Central Processing Unit	FI: Approval agency of Finland; Electrical Inspectorate
BER: Bit Error Rate	CR: Cathode Ray Tube	FIPS PUB: Federal Information Processing Standard Publication
BIC: Building Industry Consultant	CSMA/CD: Carrier Sense Multiple Access/ Collision Detection	FM: Frequency modulation
BICSI: Building Industry Consulting Service International	CSPE: Chlorosulfonated Polyethylene	FOCIS: Fiber Optic Connector Intermateability Standard
BISDN: Broadband Integrated Services Digital Network	CTR: Certified Test Report	FOTP: Fiber Optic Test Procedure
BTU: British Thermal Unit	CV: Continuous vulcanization	FOTS: Fiber Optics Transmission System
CA: Cable	D-A: Digital to analog conversion	FPL: Power Limited Fire Protective Signaling Circuit Cable, NEC Article 760 Cable Designation
CATV: (1) Community Antenna Television; Cable Access Television (2) CATV Cable, NEC Article 820 Cable Designation	DAF: Dedicated Access Facility	FPLP: Power Limited Fire Protective Signaling Circuit Plenum Cable, NEC Article 760 Cable Designation
CATVP: CATV Plenum Cable, NEC Article 820 Cable Designation	dB: Decibel	FPLR: Power Limited Fire Protective Signaling Circuit Riser Cable, NEC Article 760 Cable Designation
CATVR: CATV Riser Cable, NEC Article 820 Cable Designation	DBS: Direct Broadcast Satellite	FR-1: A flammability rating established by Underwriter's Laboratories for wires and cables that pass a specially designed vertical flame test
CATVX: CATV Limited Use Cable, NEC Article 820 Cable Designation	dc: Direct current	freq: Frequency
CB: Citizens band	DCE: Data Circuit-Terminating Equipment	FRICC: Federal Research Internet Coordinating Committee (now FNC)
C-C: Conductor to conductor capacitance	DCO: Digital Central Office	FRPE: Flame Retardant Polyethylene
CCITT: The International Telegraph and Telephone Consultative Committee	DCR: Direct Current Resistance	ft: Foot
CCTV: Closed-circuit television	DD: Distribution Designer or Distribution Device	FTP: Fire Transfer Protocol
CDDI: Copper Distributed Data Interface	DEMARC: Demarcation point	ga: Gauge
CDF: Central Distribution Frame	DEMKO: Approval agency of Denmark	gHZ: Gigahertz
CDO: Community Dial Office	DGM: Data Grade Medium	grd: Ground
CEBEC: Belgium approval agency; Commitee Electrotechnique Belge Service de la Marque	DISA: Defense Information Systems Agency (formerly DCA)	GTO: Gas tube sign and oil-burner ignition cable. 5,000V-15,000V.
CEE: European standards agency; International Commission on Rules for the Approval of Electrical Equipment	DISI: Directory Information Services Infrastructure	H: Designation for intensity of magnetic energy
	DIST: District	hc: Handset combination (single-line telephone)
	DRT: Plastic range and dryer cord (CSA)	HC: Horizontal cross-connect
	DTE: Data Terminal Equipment	hck: Handset combination; key (six-button telephone)
	DVD: Digital Versatile Disc	HDPE: High Density Polyethylene
	DW: Distribution Wire	HF: High Frequency

Abbreviations & Acronyms

- hh:** Handhole
- Hi-Pot:** A test designed to determine the highest voltage that can be applied to a conductor without breaking through the insulation.
- HPD:** Rubber- and asbestos-insulated heater cord. No braid on individual conductors but with braid overall. Also made with neoprene insulation and no asbestos or PVC/NBC.
- HPN:** Two-conductor, neoprene-insulated heater cord. Parallel construction. For use in damp locations.
- HSJ:** Same as type HS but with #18, #16 and #14 conductors and differing thickness of jacket.
- HVAC:** Heating, ventilation and air conditioning
- Hz:** Hertz
- i:** Symbol used to designate current
- IC:** Intermediate cross-connect
- ICEA:** Insulated Cable Engineers Association
- IDC:** Insulation Displacement Connector
- IEC:** International Electrotechnical Commission
- IEEE:** Institute of Electrical and Electronics Engineers
- IGS:** Integrated Gas Spacer Cable, NEC Article 325 Cable Designation
- IMSA:** International Municipal Signal Association
- in:** Inch
- IRSG:** Internet Research Steering Group
- IRTF:** Internet Research Task Force
- IS:** International Standard
- ISA:** Instrument Society of America
- ISDN:** Integrated Services Digital Network
- ISO:** International Organization for Standardization
- ISOC:** Internet Society
- ITCO:** Independent Telephone Company
- ITU-T:** International Telecommunications Union - Telecommunications Standardization Section
- IW (C):** Inside Wiring (cable)
- J:** Joule
- kcmil:** One thousand circular mils
- KEMA KEUR:** Approval agency of the Netherlands
- kft:** An abbreviation for 1000 ft.
- kHz:** Kilohertz
- Kilo:** A numerical prefix denoting 1000 (10^3)
- km:** Kilometer
- KTS:** Key Telephone Service
- kV:** Kilovolt
- kVA:** Kilovolt Ampere
- kW:** Kilowatt
- LAN:** Local Area Network
- LASER:** Light Amplification by Stimulated Emission of Radiation
- LATA:** Local Access Transport Area
- lbf:** Pound force
- LBO:** Line Buildout
- LDPE:** Low Density Polyethylene
- LEC:** Local Exchange Carrier
- LED:** Light-Emitting Diode
- LLDPE:** Linear Low Density Polyethylene
- LOCA:** Loss of Coolant Accident
- locap:** Low-capacitance, low-loss paired cable
- MAC:** Moves, Adds and Changes
- MAP:** Manufacturing Automation Protocol
- MATV:** Master Antenna Television
- Mbps:** Megabits per second
- MC:** (1) main cross-connect (2) Metal Clad Cable, NEC Article 334 Cable Designation
- MCM:** One thousand circular mils
- MDF:** Main Distribution Frame
- MDPE:** Medium Density Polyethylene
- Meg or Mega:** A numerical prefix denoting 1,000,000 (10^6)
- M/G:** Motor/Generator Set
- MH:** Manhole
- Mho:** The unit of conductivity. The reciprocal of an ohm.
- MHz:** Megahertz
- MI:** Mineral Insulated Cable, NEC Article 330 Cable Designation
- Micro:** A numerical prefix denoting one-millionth (10^6)
- MIL STD:** Military Standard
- MILNET:** Military Network
- MLT:** Multi-Level Threshold
- mm:** Millimeter
- Modem:** Modulator demodulator
- MTT:** Main Telephone Terminal
- MTW:** Machine Tool Wire
- MV:** Medium Voltage Cable, NEC Article 326 Cable Designation
- MW:** Radio hookup wire with polyvinyl insulation and plain or nylon jacket or braid, or shield, 1000V
- N:** Newton
- NAIC:** Network Applications and Information Center
- NASA:** National Aeronautics and Space Administration
- NBR:** Natural butadiene-acrylonitrile copolymer rubber
- NBS:** National Bureau of Standards (now NIST)
- NEC:** National Electrical Code
- NEMA:** National Electrical Manufacturers Association
- NEMKO:** Approval agency of Norway
- NESC:** National Electrical Safety Code
- NEXT:** Near End Crosstalk
- nf:** Nanofarad
- NFPA:** National Fire Protection Association
- NI:** Network Interface
- NID:** Network Interface Device
- NIST:** National Institute of Standards and Technology (formerly NBS)
- NIU:** Network Interface Unit
- nm:** Nanometer
- NM & NMC:** Non Metallic Sheathed Cable, NEC Article 336 Cable Designation
- NPLF:** Non Power-Limited Fire Protective Signaling Circuit Cable, NEC Article 760 Cable Designation
- NPLFP:** Non Power-Limited Fire Protective Signaling Circuit Plenum Cable, NEC Article 760 Cable Designation
- NPLFR:** Non Power-Limited Fire Protective Signaling Circuit Plenum Cable, NEC Article 760 Cable Designation
- NRZ:** Non Return to Zero
- NRZI:** Non Return to Zero Inverted
- OC:** Optical Carrier
- ODC:** Ozone Depleting Chemical
- OP:** Outside Plant
- OPE:** Outside Plant Engineer
- OSHA:** Occupational Safety and Health Administration
- OSI:** Open Systems Interconnection
- OVE:** Approval agency of West Germany; Oesterreichischer Verband für Elektrotechnik
- PABX:** Private Automatic Branch Exchange
- PAM:** Pulse Amplitude Modulation
- PAP:** A commonly used term for air core (unfilled) direct burial telephone cable with a corrugated aluminum shield
- PBX:** Private Branch Exchange
- PC:** Personal Computer
- PCB:** Printed Circuit Board
- P-FEP:** General Cable proprietary dielectric material used in junction with FEP.
- PCM:** Pulse Code Modulation
- PCP:** A commonly used term for air core (unfilled) direct burial cable with a corrugated copper shield
- PE:** Polyethylene
- pf:** Picofarad
- PFA:** Polyfluoroalkoxy
- PIC:** A general term for any type of plastic insulated telephone cable
- Pico:** A numerical prefix denoting one-millionth of one-millionth (10^{-12})
- PL:** Private Lines
- PLSJ:** All-rubber, parallel-jacketed, two-conductor, light-duty cord for pendant or portable use in damp locations. 300V.
- PLT:** (1) Plant (2) Same as PLSJ except thermoplastic insulation
- PLTC:** Power Limited Tray Cable, NEC Article 725 Cable Designation
- PM:** Phase Modulation
- POI:** Point Of Interface
- POSJ:** All-rubber, parallel, light duty rip-cord for use on lamps and small appliances, 300V, 60°C
- POT:** Thermoplastic, parallel, light duty rip-cord. 300V, 60°C to 105°C.
- POTS:** Plain Old Telephone Service (colloquial)
- PP:** Polypropylene
- PR:** Pair
- PTFE:** Polytetrafluoroethylene
- PTSS:** Passive Transmission Sub-System
- PVC:** Polyvinyl Chloride
- PVDF:** Polyvinylidene Fluoride
- R:** Symbol for resistance
- R-F:** Radio-frequency
- RCDD:** Registered Communication Distribution Designer
- REA:** Rural Electrification Administration
- REP:** Repair
- RFQ:** Request for Quote
- RG/U:** General utility grade military coaxial cable
- RH:** Relative humidity
- RJ-45:** A specific pin-point assignment for an eight position modular telecommunications connector.
- RMS:** (1) rack mount space (2) Root Mean Squares
- RoHS:** Restriction on Hazardous Substances
- S:** Heavy-duty, rubber-insulated portable cord. Stranded copper conductors with separator and individual rubber insulation. Two or more color-coded conductors cabled with filler, wrapped with separator and rubber jacketed overall, 600 Volts.
- SAE:** Society of Automotive Engineers
- SANZ:** Standards Association of New Zealand
- SBR:** Styrene Butadiene Rubber
- ScTP:** Screened Twisted Pair
- SDN:** Switched Digital Network

Abbreviations & Acronyms

SE: Service Entrance Cable, NEC Article 338 Cable Designation	SWR: Standing Wave Ratio
SEMKO: Approval agency for Sweden	SYS: System
SFTP: Simple File Transfer Protocol	TC: (1) Power and Control Tray Cable, NEC Article 340 Cable Designation (2) Telecommunications Closet
SI: System Internationale	TCP: Transmission Control Protocol
SJ: Junior hard-service, rubber-insulated pendant or portable cord. Same construction as type S, but 300V. Jacket thickness different.	TDM: Time-Division Multiplexing
SJO: Same as SJ, but carolprene, oil-resistant compound outer jacket. Can also be made "water-resistant." 300V, 60°C.	TEL: Telephone
SJT: Junior hard service thermoplastic or rubber-insulated conductors with overall thermoplastic jacket, 300V, 60°C to 105°C.	TELCO: Telephone Company
SJTO: Same as SJT but oil-resistant thermoplastic outer jacket. 60°C.	TERM: Terminal or termination
SMTP: Simple Mail Transfer Protocol	TEW: Canadian Standard Association type appliance wires. Solid or stranded single conductor, plastic-insulated, 600V, 105°C.
SNA: Systems Network Architecture	TF: Fixture wire, thermoplastic-covered solid or seven strands. 60°C.
SNM: Shielded Non Metallic Sheathed Cable, NEC Article 337 Cable Designation	TFE: Tetrafluoroethylene
SNMP: Simple Network Management Protocol	TFF: Same as TF but flexible stranding. 60°C.
SNR: Signal to Noise Ratio	THHN: 90°C, 600V nylon jacketed building wire
SO: Hard-service cord, same construction as type S except oil-resistant carolprene jacket, 600V, 60° to 90°C.	THW: Thermoplastic vinyl-insulated building wire. Flame-retardant, moisture- and heat-resistant. 75°C. Dry and wet locations.
SONET: Synchronous Optical Network	THWN: Same as THW but with nylon jacket overall. 75°C.
SP-1: All rubber, parallel-jacketed, two-conductor light-duty cord for pendant or portable use in damp locations. 300V.	TIA: Telecommunications Industry Association
SP-2: Same as SP-1, but heavier construction, with or without third conductor for grounding purposes. 300V.	TOC: Tin Overcoat
SP-3: Same as SP-23, but heavier construction for refrigerators or room air conditioners. 300V.	TP: Transport Protocol
SPC: Stored Program Control	TP-PMD: Twisted Pair-Physical Medium Dependent
SPG: Single Point Ground	TPDDI: Twisted Pair Distributed Data Interface
SPT-1: Same as SP-1, except all-thermoplastic. 300V. With or without third conductor for grounding.	TSB: Telecommunications System Bulletin
SPT-2: Same as SP-2, except all-thermoplastic. 300V. With or without third conductor for grounding.	TT: Telephone Terminal
SPT-3: Same as SP-3, except all-thermoplastic. 300V. With or without third conductor for grounding.	TTB: Telephone Terminal Board
SRD: Portable range or dryer cable. Three or four rubber-insulated conductors with rubber or neoprene jacket, flat or round construction. 300V, 60°C.	TTY: Text Telephones
SRDT: Same as SRD, except all-thermoplastic with a maximum temperature of 90°C.	TW: Thermoplastic vinyl-jacketed building wire, moisture-resistant. 60°C.
SRL: Structural return loss	UCC: Uniform Code Council
ST: Hard-service cord, jacketed, same as type S except all-plastic construction, 600V, 60°C to 105°C.	UF: Thermoplastic underground feeder and branch circuit cable
STA: Station	UF: Underground Feeder and Branch Circuit Cable, NEC Article 339 Cable Designation
STO: Same as ST but with oil-resistant thermoplastic outer jacket. 600V, 60°C.	UG: Underground
STP: Shielded twisted pair	UHF: Ultra High Frequency, 300 to 3,000 MHz
SV: Vacuum cleaner cord, two or three-conductor, rubber-insulated. Overall rubber jacket. For light-duty in damp locations. 300V, 60°C.	UL: Underwriter's Laboratories, Inc.
SVO: Same as SV except carolprene jacket, 300V, 60°C.	µm: Micron or micrometer
SVT: Same as SV except all-plastic construction. With or without third conductor for grounding purposes only. 300V, 60°C to 90°C.	UPC: Universal Packaging Code
SW: Station Wire	UPS: Uninterruptible Power Supply
SWB: Switchboard	USE: Underground Service Entrance Cable, NEC Article 338 Cable Designation
	UTE: Approval agency for France; Union Technique de l'Electricite
	UTP: Unshielded twisted-pair
	V: Volt
	VDE: West Germany approval agency
	VHF: Very High Frequency, 30 to 300 MHz
	VP: Velocity of Propagation
	VSWR: Volume Standing Wave Ratio
	VW-1: A flammability rating established by Underwriters Laboratories for wires and cables that pass a specially designed vertical flame test, (formerly designated FR-1)
	W: Symbol for watt or wattage
	WA: Work area
	WP: Waterproof Outlet
	X: Cross-connect
	XLPE: Crosslinked polyethylene
	Z: Symbol for impedance

Hook-Up Wire Product Finder

TEMP. °C	VOLTAGE	UL	UL	CSA	MIL	AWG	P/N	STRAND TYPE	PAGE
60	1500*	—	—	—	—	20	C1326	STRANDED	7
60	3000*	—	—	—	—	20	C1319	STRANDED	7
60	5000*	—	—	—	—	18	C1320A	STRANDED	7
60	5000*	—	—	—	—	18	C1321	STRANDED	7
60	10000*	—	—	—	—	18	C1318	STRANDED	7
80	1000	—	—	—	W-76B	24	C7600A	STRANDED	4
80	1000	—	—	—	W-76B	22	C7602A	STRANDED	4
80	1000	—	—	—	W-76B	20	C7604A	STRANDED	4
80	1000	—	—	—	W-76B	18	C7606A	STRANDED	4
80	1000	—	—	—	W-76B	16	C7608A	STRANDED	4
80	1000	—	—	—	W-76B	14	C7610A	STRANDED	4
80	1000	—	—	—	W-76B	12	C7611A	STRANDED	4
80/105	300	1007	1569	TR-64	—	24	C2003A	SOLID	2
80/105	300	1007	1569	TR-64	—	24	C2015A	STRANDED	2
80/105	300	1007	1569	TR-64	—	22	C2004A	SOLID	2
80/105	300	1007	1569	TR-64	—	22	C2016A	STRANDED	2
80/105	300	1007	1569	TR-64	—	20	C2028A	SOLID	2
80/105	300	1007	1569	TR-64	—	20	C2040A	STRANDED	2
80/105	300	1007	1569	TR-64	—	18	C2052A	SOLID	2
80/105	300	1007	1569	TR-64	—	18	C2064A	STRANDED	2
80/105	300	1007	1569	TR-64	—	16	C2053A	SOLID	2
80/105	300	1007	1569	TR-64	—	16	C2065A	STRANDED	2
105	600	1015	—	TEW	—	24	C2100A	STRANDED	3
105	600	1015	—	TEW	—	22	C2101A	STRANDED	3
105	600	1015	—	TEW	—	22	C2117A	SOLID	3
105	600	1015	—	TEW	—	20	C2102A	STRANDED	3
105	600	1015	—	TEW	—	20	C2118A	SOLID	3
105	600	1015	—	TEW	—	18	C2103A	STRANDED	3
105	600	1015	—	TEW	—	18	C2119A	SOLID	3
105	600	1015	—	TEW	—	16	C2104A	STRANDED	3
105	600	1015	—	TEW	—	14	C2105A	STRANDED	3
105	600	1015	—	TEW	—	12	C2106A	STRANDED	3
105	600	1015	—	TEW	—	10	C2107A	STRANDED	3

* For intermittent duty only

Multi-Conductor Cable Product Finder

NO. COND.	STRAND TYPE	AWG 28	AWG 24	AWG 22	AWG 20	AWG 19	AWG 18	AWG 16	AWG 14	AWG 12
		P/N SHIELD PAGE	P/N SHIELD PAGE	P/N SHIELD PAGE	P/N SHIELD PAGE	P/N SHIELD PAGE	P/N SHIELD PAGE	P/N SHIELD PAGE	P/N SHIELD PAGE	P/N SHIELD PAGE
1	SOLID									
	STRANDED		743605 B 169		743601 B 169 743602 B 169 743603 B 169 743604 B 169 C1300 B,R 172		C1201 B,C 175 C1301 B,R 172			
2	SOLID			C2515A F 23 C2676A B 34 C4008A U 9, 43 C4167A F 29 C4408 U 138 E1000S U 134 E1482S U 117 E2000S F 135 E2100S F-P 137 E2482S S 119 E3000S U-P 136 E3482S U-P 121 E3542S F-P 123	C2509A F 164 C4311A C 9	C2754A 9	C0471 U 125 C0472 F 126 C3060 F-P 28 C3110 U-P 17 C3167 F-P 128 C3200 U-P 122 C3240 U-P 127 C3260 F-P 124 C4304A U 118 C4334A F 120 E1030S U 134 E1502S U 117 E2030S F 135 E2200S F-P 137 E2402S U 117 E2502S F 119 E3030S U-P 136 E3502S U-P 121 E3602S F-P 123	C0473 U 125 C0474 F 126 C3168 F-P 128 C3210 U-P 122 C3241 U-P 127 C3270 F-P 124 C4321A U 118 C4344A F 120 E1512S U 117 E2404S U 117 E2522S F 119 E3512S U-P 121 E3612S F-P 123	C0475 U 126 C0491 U 125 C3172 F-P 128 C3220 U-P 122 C3224 U-P 122 C3244 U-P 127 C3280 F-P 124 C4163A F 29 C4324A U 118 C4347A F 120 E1522S U 117 E2406S U 117 E2532S F 119 E3522S U-P 121 E3622S F-P 123	C0476 F 126 C0492 U 125 C3174 F-P 128 C3224 U-P 122 C3246 U-P 127 C3282 F-P 124 C4164A F 29 C4327A U 118 C4348A F 120 E1532S U 117 E2542S F 119 E3532S U-P 121 E3632S F-P 123
	STRANDED	C6500A B 37	743701 B 170 743704 B 170 743705 B 170 C0740A F 68 C1226A S 173 C1228A F 172 C1356 U 156 C2461A U 11 C2513A F 23 C4152A F 29 C4216A F 31	743706 B 170 C0431A U 22 C0450A F 32 C0760A F 69 C1322A B 174 C1362 U 156 C2514A F 23 C2516A F 23 C2518A F 23 C2520A F 24 C2677A B 36 C2679A B 36 C2882A S 33 C3105 U-P 16 C3115 U-P 17 C3154 F-P 27 C3158 F-P 28 C4100A U 18 C4153A F 29 C4168A F 29 C4192A F 30 C4210A F 30 C6310 UJ 138 C6348A U 12 E1002S U 134 E2002S F 135 E2102S F-P 137 E3002S U-P 136	743707B 170 C0433A U 22 C0452A F 32 C1302 B,R 40, 172 C1360 U 156 C1642A B 35 C2519A F 24 C2524A F 23 C2540A F 23 C2681A B 36 C2888A S 33 C3320 F-P 27 C3602 U-R 21 C4117A U 19 C4154A F 29 C4166A F 30 C4211A F 30 C6311 UJ 138 C6351A U 13 E1022S U 134 E2022S F 135 E2122S F-P 137 E3022S U-P 136		740302 U 158 C0435A U 22 C0454A F 32 C1202 B,C 41, 175 C1357 U 156 C2521A F 24 C2534A F 23 C2686A B 23 C2830A U 13 C2892A S 33 C3062 F-P 28 C3102 U-P 16 C3112 U-P 17 C3162 F-P 27 C4114A U 19 C4125A F 18 C4155A F 29 C4197A F 30 C4212A F 30 C5460 U 139 C6312 UJ 138 C6367 U 157 C7102A UJ 156 C8116 U-P 45 C8122 U-P 45 E1032S U 134 E2032S F 135 E2202S F-P 137 E3032S U-P 136	740202 U 158 C0437A U 22 C0456A F 32 C1358 U 158 C1602 B,C 41, 175 C1704 U 152 C2405A U 14 C2536A F 17 C2895A S 33 C3068 F-P 28 C3127 U-P 17 C3169 F-P 27 C3193 U-P 26 C4135A U 20 C4162A F 30 C4213A F 30 C8111 FB-P 39 E1042S U 134 E2042S F 135 E2242S F-P 137 E3042S U-P 136	740102 U 158 C0439A U 22 C0458A F 32 C1361 U 156 C1612 B,C 41 C1702 U 152 C2409A U 14 C2538A F 17 C3126 U-P 16 C4146 U-P 20 C4201A F 30 C4215A F 30 E1052S U 134 E2052S F 135 E2252S F-P 137 E3052S U-P 136	740002 U 158 C0441A U 22 C0460A F 32 C1363 U 156 C1364 U 157 C1700 U 152 C2410A U 14 C2539A F 17 C3129 U 17 C4150A U 20 C4202A F 30 E1062S U 134 E2062S F 135 E2262S F-P 137 E3062S U-P 136
3	SOLID			C4410 U 138	C2510A F 164		C1201 B,C 175 C1301 B,R 172 C3114 U-P 17 C4305A U 118 C4335A F 120 E1503S U 117 E2503S S 119 E3503S U-P 121 E3603S F-P 123	C4322A U 118 C4345A F 120	C4325A U 118	
	STRANDED	C0530A FB 72 C0939A FB 70 C6501A B 37	C0680A FB 72 C0741A F 68 C0951A FB 70 C2462A U 11 C4217A F 31 C8115 FB-P 39	C0432A U 22 C0451A F 32 C0761A F 69 C0971A FB 71 C1335A S 33 C2517A F 23 C2526A F 23 C2678A B 36 C3310 F-P 27 C4062A U 12 C4101A U 18 C4156A F 29 C4169A F 29 C4193A F 30 E1003S U 154 E2003S F 135 E2103S F-P 137 E3003S U-P 136	C0434A U 15 C0781A F 69 C1304 B,R 40 C1332A B 36 C1333A F 36 C1643A B 35 C2525A F 23 C2528A F 23 C3321 F-P 28 C3603 U-R 21 C4118A U 19 C4157A F 29 C4158A F 29 C6352A U 13 E1023S U 134 E2023S F 135 E2123S F-P 137 E3023S U-P 136		C0436A U 22 C0455A F 32 C1203 B,C 41 C2535A F 23 C2768A S 33 C2831A U 13 C3064 F-P 28 C3120 U-P 17 C3164 F-P 27 C3190 U-P 16 C4126A U 19 C4159A F 29 C4198A F 30 C8106 F-P 26 C8107 FB-P 39 E1033S U 134 E2033S F 135 E2203S F-P 137 E3033S U-P 136	C0438A U 22 C0457A F 32 C1603 B,C 41 C2406A U 14 C2537A F 23 C3194 U-P 16 C3340 F-P 27 C4136A U 20 C4165A F 29 C4200A F 30 C8119 FB-P 39 E1043S U 134 E2043S F 135 E2243S F-P 137 E3043S U-P 136	C0440A U 22 C0459A F 32	

* For intermittent duty only



B - BRAID SHIELD
C - CAROLPRENE®
F - FLEXFOIL® SHIELD
FB - FLEXFOIL® /BRAID SHIELD
I - INDIVIDUAL FLEXFOIL® SHIELD

IFB - INDIVIDUAL FLEXFOIL® + FLEXFOIL® /BRAID
P - PLENUM
R - RUBBER
S - SPIRAL SHIELD
U - NO SHIELD

UJ - UN-JACKETED



Multi-Conductor Cable Product Finder

NO. COND.	STRAND TYPE	AWG 28	AWG 24	AWG 22	AWG 20	AWG 19	AWG 18	AWG 16	AWG 14	AWG 12	
		P/N SHIELD PAGE	P/N SHIELD PAGE	P/N SHIELD PAGE	P/N SHIELD PAGE	P/N SHIELD PAGE	P/N SHIELD PAGE	P/N SHIELD PAGE	P/N SHIELD PAGE	P/N SHIELD PAGE	P/N SHIELD PAGE
4	SOLID			C4412 U138 E1001S U134 E1484S U117 E2484S F119 E3001S U-P136				C0485 U125 C0494 F126 C3061 F-P28 C3111 U-P17 C3170 F-P128 C3201 U-P122 C3242 U-P127 C4306A F118 C4336A F120 E1504S U117 E2504S F119 E3504S U-P121 E3604S F-P123	C0486 U125 C3171 F-P128 C3223 U-P122 C3243 U-P127 C3284 F-P124 C4323A U118 C4346A F120 E1514S U117 E2524S F119 E3514S U-P121 E3614S F-P123	C0496 F126 C3173 U-P128 C3223 U-P122 C3245 U-P127 C3284 F-P124 C4326A U118 E1524S U117 E2534S F119 E3524S U-P121 E3624S F-P123	C0497 F126 C3175 F-P128 C3225 U-P122 C3247 U-P127 C3283 F-P124 E1534S U118 E2544S F119 E3534S U-P121 E3634S F-P122
	STRANDED	C0531A FB72 C0940A FB70 C6502A B37	C0681A FB72 C0742A F68 C0952A FB70 C2463A U11 C4218A F3	C0762A F69 C0972A FB71 C1118 U139 C1337A S33 C1340A F160 C2523A F23 C2680A B36 C3106 U-P16 C3116 U-P17 C3155 F-P27 C3159 F-P28 C4063A U12 C4102A U18 C4160A F29 C4194A F30 C5076 U139 E1004S U134 E2004S F135 E2104S F-P137 E3004S U-P136	C0782A F69 C1119 U139 C1305 B.R40 C1331A F160 C1343A F160 C1644A B35 C2555A F23 C2683A B36 C3322 F-P27 C3604 U.R21 C4119A U19 C4161A F29 C4196A F30 C5078 U139 C6353A U13 E1024S U134 E2024S F135 E2124S F-P137 E3024S U-P136			740304 U158 C0444A U22 C1123 U139 C1204 B.C41 C2404A U13 C2543A F25 C2688A B36 C3063 F-P28 C3103 U-P16 C3113 U17 C3163 F-P27 C4127A U19 C4204A F30 C5084 U139 C8102 U-P15 C8110 FB-P39 C8114 F-P26 E1034S U134 E2034S F135 E2204S F-P137 E3034S U-P136	740204 U158 C1604 B.C41 C1705 U152 C2425A U14 C3195 U-P16 C3341 F-P27 C4137A U20 E1044S U134 E2044S F135 E2244S F-P137 E3044S U-P136	740104 U158 C1614 B.C41 C1703 U152 C2430A U14 C4147A U20 E1054S U134 E2054S F135 E2254S F-P137 E3054S U-P136	740004 U158 C1701 U152 C2440A U14 C4151A U20 E1064S U134 E2064S F135 E2264S F-P137 E3064S U-P136
5	SOLID						C3117 U-P17 C4307A U118 C4337A F120	C4349A U118 C4350A F120			
	STRANDED	C0532A FB72 C0941A FB70	C0682A FB72 C0753A F68 C0953A FB70 C2464A U11 C4219A F31	C0973A FB71 C1124 U139 C4064A U12 C4103A U18 C5086 U139 C6355A U13	C1126 U139 C1308 B.R40 C1645A B35 C3605 U.R21 C4120A U19 C6355A U13		C2420A U13 C4128A U19	C2434A U14 C4138A U20	C2437A U14 C4148A U20		
6	SOLID			C4300A U118			C3118 U-P17 C4308A U118 C4338A F120 E1506S U117 E2506S F119 E3506S U-P121 E3606S F-P123				
	STRANDED	C0533A FB72 C0942A FB70 C6503A B37	C0683A FB72 C0743A F68 C0954A FB70 C1345A F159 C2466A U11 C4220A F31	C0763A F69 C0974A FB71 C1341A S33 C3311A F-P27 C4066 U12 C4104A U18 C4207A F30 E1006S U134 E2006S F135 E2106S F-P137 E3006S U-P136	C0783A F69 C1310 B.R40 C1646A B35 C3606 U.R21		C1206 B.C41 C3065 F-P28 C3121 U-P17 C3166 F-P27 C3192 U-P16 C4205A F30 C4206A U19 C8120 FB-P39 E1036S U134 E2036S F135 E2206S F-P137 E3036S U-P136	C1606 B.C41 C8108 FB-P39			
7	SOLID						C4309A U118 C4339A F120				
	STRANDED	C0534A FB72 C0943A FB70	C0684A FB72 C0754A F68 C0955A FB70 C2468A U11 C4221A F31	C0975A FB71 C4088A U12 C4105A U18	C1312 B.R40 C3607 U.R21 C4121A U19 C6356A U13		C2421A U-P13 C4129A U19	C2426A U14 C4139A U20	C2431A U14 C4149A U20		
8	SOLID						C3119 F17 C4310A U118 C4340A F120 E1508S117 E2508S119				
	STRANDED	C0535A FB72 C0944A FB70 C6504A B37	C0685A FB72 C0744A F68 C0956A FB70 C2465A U11 C4222A F31	C0764A F69 C0976A FB71 C1130A U139 C4065A U12 C4080 U139 C4106A U18 C4208A F30 C5096 U139 E1008S U134 E2008S F135 E2108S F-P137 E3008S U-P136	C0784A F69 C1313 B.R40 C1648A FB38 C3608 U.R21 C4090 U139		C1208 B.C41 C3122 U-P17 C3180 F-P27 C3191 U-P16 E1038S U134 E2038S F135 E2208S F-P137 E3038S U-P136	C1608 B.C41 C2443A U14 C4140A U20			



B - BRAID SHIELD
C - CAROLPRENE®
F - FLEXFOIL® SHIELD
FB - FLEXFOIL® /BRAID SHIELD
I - INDIVIDUAL FLEXFOIL® SHIELD

IFB - INDIVIDUAL FLEXFOIL® + FLEXFOIL® /BRAID
P - PLENUM
R - RUBBER
S - SPIRAL SHIELD
U - NO SHIELD

UJ - UN-JACKETED



Multi-Conductor Cable Product Finder

NO. COND.	STRAND TYPE	AWG 28	AWG 24	AWG 22	AWG 20	AWG 19	AWG 18	AWG 16	AWG 14	AWG 12
		P/N SHIELD PAGE	P/N SHIELD PAGE	P/N SHIELD PAGE	P/N SHIELD PAGE	P/N SHIELD PAGE	P/N SHIELD PAGE	P/N SHIELD PAGE	P/N SHIELD PAGE	P/N SHIELD PAGE
9	SOLID						C4312A U 118 C4341A F 120			
	STRANDED	C0536A FB 72 C0945A FB 70	C0686A FB 72 C0755A F 68 C0957A FB 70 C2470A U 11 C4223A F 31	C0977A FB 71 C4070A U 12 C4107A U 18	C4122A U 19 C6357A U 13			C2422A U 13 C4130A U 19	C2435A U 14 C4141A U 20	
10	SOLID				C2511A F 164		C4313A U 118 C4342A F 120			
	STRANDED	C0537A FB 72 C0946A FB 70 C6505A B 37	C0687A FB 72 C0745A F 68 C0958A FB 70 C2471A U 11	C0765A F 69 C0978A FB 71 C4071A U 12 C4108A U 18 E1010S U 134 E2010S F 135	C0785A F 69 C3610 U,R 21 C4123A U 19		C1210 B,C 41 C3178 U-P 16 C3181 F-P 27 E1040S U 134 E2040S F 135			
11	SOLID						C4314A U 118			
	STRANDED									
12	SOLID									
	STRANDED	C6506A B 37	C2467A U 11	C4067A U 12 C4109A U 18 E1012S U 134 E2012S F 135	C6360A U 13		C1212 B,C 41 C2412A U 13 C3179 U-P 16 C3182 F-P 27 C4131A U 19 E1041S U 134 E2041S F 135	C2427A U 14 C4142A U 20		
15	SOLID			C4301A U 118			C4315A U 118			
	STRANDED	C0538A FB 72 C0947A FB 70 C6507A B 37	C0688A FB 72 C0746A F 68 C0959A FB 70 C2473A U 11 C4225A F 31	C0766A F 69 C0979A FB 71 C4073A U 12 C4110A U 18	C6358A U 13 C0786A F 69 C4124A U 19		C2423A U 13 C4132A U 19	C2428A U 14 C4143A U 20		
18	SOLID									
	STRANDED			C4111A U 18						
19	SOLID									
	STRANDED						C2424A U 13 C4133A U 19	C2429A U 14 C4144A U 20		
20	SOLID			C4302A U 118			C4316A U 118			
	STRANDED	C6508A B 37	C0747A F 68 C0960A FB 70 C4226A F 31	C0767A F 69 C0980A FB 71 C4075A U 12 C4112A U 18	C0787A F 69					
21	SOLID						C4317A U 118			
	STRANDED									
25	SOLID									
	STRANDED	C0948A FB 41	C0748A F 68 C0961A FB 70 C4227A F 31	C0768A F 69 C0981A FB 71 C4076A U 12 C4113A U 18	C0788A F 69		C2433A U 13 C4134A U 19	C2436A U 14 C4145A U 20		
30	SOLID						C4318A U 118 C4343A F 120			
	STRANDED		C0749A F 68 C4228A F 31	C4077A U 12 C4114A U 18						
40	SOLID									
	STRANDED		C0750A F 68 C4229A F 31	C4079A U 12 C4116A U 18						
50	SOLID									
	STRANDED		C0751A F 68 C4230A F 31	C4079A U 12 C4116A U 18						



B - BRAID SHIELD
 C - CAROLPRENE®
 F - FLEXFOIL® SHIELD
 FB - FLEXFOIL® /BRAID SHIELD
 I - INDIVIDUAL FLEXFOIL® SHIELD

IFB - INDIVIDUAL FLEXFOIL® + FLEXFOIL® /BRAID
 P - PLENUM
 R - RUBBER
 S - SPIRAL SHIELD
 U - NO SHIELD

UJ - UN-JACKETED



Multi-Paired Cable Product Finder

NO. PAIRS	STRAND TYPE	AWG 28			AWG 24			AWG 23			AWG 22			AWG 20			AWG 18			
		P/N	SHIELD	PAGE	P/N	SHIELD	PAGE	P/N	SHIELD	PAGE	P/N	SHIELD	PAGE	P/N	SHIELD	PAGE	P/N	SHIELD	PAGE	
1	SOLID												C4008A U.....	9, 43						
	STRANDED				740601 IF.....		166						C3204 F-P.....	48			C6101A U.....	44		
2	SOLID				C4413 U.....		138						C1670A F.....	46						
	STRANDED	C0804A FB.....		79	C0515A FB.....		78						C0550A F.....	66	C7106A IF.....	58	C0560A F.....	66		
3	SOLID												C4328A U.....	129						
	STRANDED	C0805A FB.....		79	C0516A FB.....		78						C0551A F.....	66	C6052A IF.....	82	C0561A F.....	66		
4	SOLID				E1842S U.....		162	E1843S U.....		162			C1676A F.....	46						
	STRANDED	C0806A FB.....		79	740604 IF.....		166						C0552A F.....	66	C1368A IF.....	80	C0562A F.....	66		
4.5	SOLID																			
	STRANDED				C3217 F-P.....		55													
5	SOLID																		C6120A U.....	31
	STRANDED	C0807A FB.....		79	C0518A FB.....		78						C0653A FB.....	75						



B - BRAID SHIELD
 C - CAROLPRENE®
 F - FLEXFOIL® SHIELD
 FB - FLEXFOIL® /BRAID SHIELD
 I - INDIVIDUAL FLEXFOIL® SHIELD

IFB - INDIVIDUAL FLEXFOIL® + FLEXFOIL® /BRAID
 P - PLENUM
 R - RUBBER
 S - SPIRAL SHIELD
 U - NO SHIELD

UJ - UN-JACKETED



Multi-Paired Cable Product Finder

NO. PAIRS	STRAND TYPE	AWG 28			AWG 24			AWG 23			AWG 22			AWG 20			AWG 18		
		P/N	SHIELD	PAGE	P/N	SHIELD	PAGE	P/N	SHIELD	PAGE	P/N	SHIELD	PAGE	P/N	SHIELD	PAGE	P/N	SHIELD	PAGE
6	SOLID										C1671A F46 C4329A U129 C6036A IF.....81						C4333A U129		
	STRANDED				740706 IF.....168 C0519A FB78 C0605A F73 C0624A FB75 C0839A FB77 C0899A F74 C0913A IF83 C3031 F-P56 C3165 F-P48 C3218 F-P55 C4175A F53 C6066A IF.....82						C0553A F66 C0573A IF65 C0654A FB75 C0725A F73 C3208 F-P48 C3356 F-P52 C4188A F54 C6017A U43 C6041A IF82		C6053A IF.....82 C6062A IF.....165			C0563A F66 C0587A IF.....65 C6048A IF82 C6106A U44			
7	SOLID																		
	STRANDED	C0808A FB79			C0520A FB78 C0606A F73 C0625A FB75 C0833A FB77 C4176A F53						C0655A FB75								
8	SOLID																		
	STRANDED				740608 IF.....166 740508 F167 740708 IF168 C0521A FB78 C0607A F73 C0626A FB75 C4177A F53						C0656A FB75						C6121A U44		
9	SOLID										C1672A F46								
	STRANDED				740709 IF.....168 C0608A F73 C0914A IF83 C4178A F53 C6067A IF.....82						C0554A F66 C0574A IF65 C0726A F73 C4189A F54 C6042A IF82		C6054A IF.....82			C0564A F66 C0588A IF.....65 C6049A IF82 C6109A U44			
10	SOLID																		
	STRANDED	C0810A FB79			C0522A FB78 C0609A F73 C0628A FB75 C0835A FB77 C4179A F53						C0658A FB75								
11	SOLID																		
	STRANDED				C0915A IF.....83						C6043A IF.....82								
12	SOLID										C4330A U129								
	STRANDED	C0812A FB79			740512 IF.....167 740612 IF166 740712 IF168 C0836A FB77 C0916A IF.....83						C6059A IF.....82		C6056A IF.....82			C6050A IF82			
12.5	SOLID																		
	STRANDED				C0523A FB78 C0630A FB75 C0897A F74 C3152 F-P48						C0660A FB75								
15	SOLID										C1673A F46 C4331A U129								
	STRANDED				C0524A FB78 C0610A F73 C0917A IF83 C4180A F53						C0728A F73 C4190A F54 C6044A IF82		C6058A IF.....82			C6051A IF82			



B - BRAID SHIELD
C - CAROLPRENE®
F - FLEXFOIL® SHIELD
FB - FLEXFOIL® /BRAID SHIELD
I - INDIVIDUAL FLEXFOIL® SHIELD

IFB - INDIVIDUAL FLEXFOIL® + FLEXFOIL® /BRAID
P - PLENUM
R - RUBBER
S - SPIRAL SHIELD
U - NO SHIELD

UJ - UN-JACKETED



Multi-Paired Cable Product Finder

NO. PAIRS	STRAND TYPE	AWG 28			AWG 24			AWG 23			AWG 22			AWG 20			AWG 18		
		P/N	SHIELD	PAGE	P/N	SHIELD	PAGE	P/N	SHIELD	PAGE	P/N	SHIELD	PAGE	P/N	SHIELD	PAGE	P/N	SHIELD	PAGE
16	SOLID																		
	STRANDED				740516 IF.....167														
17	SOLID																		
	STRANDED										C6060A IF.....82								
18	SOLID																		
	STRANDED				C0525A FB.....78														
19	SOLID																		
	STRANDED				C0611A F.....73						C6045A IF.....82								
20	SOLID																		
	STRANDED				740520 IF.....167														
25	SOLID																		
	STRANDED				C0526A FB.....78														
27	SOLID																		
	STRANDED										C4332A U.....129								
28	SOLID																		
	STRANDED				740528 IF.....167														
42	SOLID																		
	STRANDED				740542 IF.....167														
51	SOLID																		
	STRANDED										C6451A F.....47								
52	SOLID																		
	STRANDED				740552 IF.....167														

NEC/CEC Substitution Chart

Communication wire and cable for premise installations in accordance with Article 800, and other applicable parts of the National Electrical Code (NEC), latest issue. Communication wire and cables for Canada are in accordance with the harmonized Canadian Standard Association C22.2 No. 214, Underwriters Laboratories UL 444, latest issue.

Figure 800-53, Cable Substitution Hierarchy

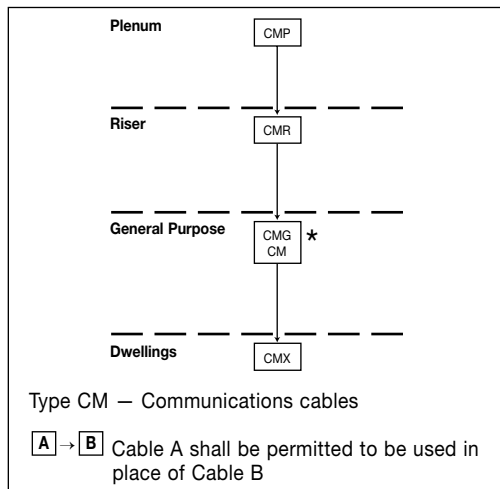

*CMG can be substituted CM—CM can be substituted for CMG

Figure 725-61, Cable Substitution Hierarchy

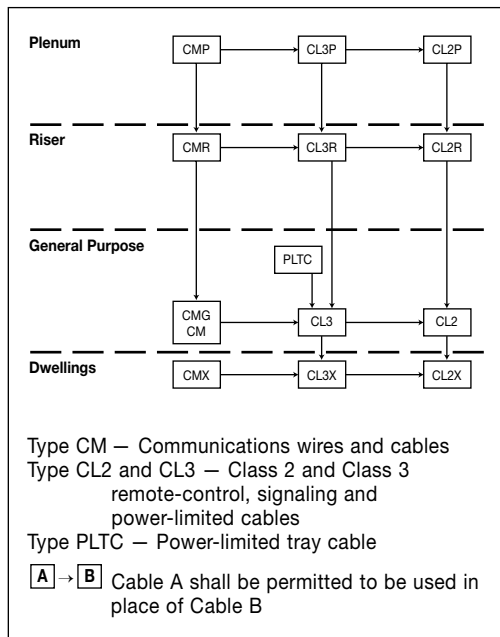

FREE RESISTANCE LEVEL	TEST REQUIREMENT	NEC ARTICLE			
		800	725	760	820
(Highest) Plenum Cables	NFPA 262 (Steiner Tunnel) CSA-CMP (Steiner Tunnel)	CMP	CL3P CL2P	FPLP	CATVP
Riser Cables Multiple Floors	UL-16666 (Vertical Shaft) CSA-CMG (Vertical Tray)		CL3R CL2R	FPLR	CATVR
General-Purpose Cables	UL-1581 (Vertical Tray)	CMG	CL3	FPL	CATV
(Lowest) Residential Cables Restricted Use	CSA-CMG (Vertical Tray) UL-1581 VW-1	CMX	CL2 CL3X		CATVX

Notes: 1. Cables with a higher fire resistance level may be substituted for those with a lower fire resistance level.
2. Non-fire rated outside plant telephone cables may not run outside of a rigid metal conduit more than 50 feet from the point of entrance into a building.
3. Cables rated cmg or cm may be used in runs penetrating one floor. (nec 800-53)

ARTICLE 800

Table 800-53. Cable Uses and Permitted Substitutions

CABLE TYPE	USE	REFERENCE	PERMITTED SUBSTITUTIONS
CMP (FT-6)	Communications plenum cable	800-53 (a)	
CMR (FT-4)	Communications riser cable	800-53 (b)	CMP
CMG (FT-4) CM (FT-1)	Communications general purpose cable	800-53 (c)	CMP, CMR, MPG, MP
CMX (FT-1)	Communications cable, limited use	800-53 (d)	CMP, CMR, CMG, CM

Note: See Figure 800-53, Cable Substitution Hierarchy

ARTICLE 725

Table 725-61. Cable Uses and Permitted Substitutions

CABLE TYPE	USE	REFERENCE	PERMITTED SUBSTITUTIONS
CL3P	Class 3 plenum cable	725-61(a)	CMP
CL2P	Class 2 plenum cable	725-61(b)	CMP, CL3P
CL3R	Class 3 riser cable	725-61(b)	CMP, CL3P, CMR
CL2R	Class 2 riser cable	725-6 (b)	CMP, CL3P, CL2P, CMR, CL3R
PLTC	Power-limited tray cable	725-61(c) and (d)	
CL3	Class 3 cable	725-61(b), (e) and (f)	CMP, CL3P, CMR, CL3R, CMG, CM, PLTC
CL2	Class 2 cable	725-61(b), (c) and (f)	CMP, CL3P, CL2P, CMR, CL3R, CL2R, CMG, CM, PLTC, CL3
CL3X	Class 3 cable, limited use	725-61(b) and (e)	CMP, CL3P, CMR, CL3R, CMG, CM, PLTC, CL3, CMX
CL2X	Class 2 cable, limited use	725-61(b) and (e)	CMP, CL3P, CL2P, CMR, CL3R, CL2R, CMG, CM, PLTC, CL3, CL2, CMX, CL3X

Note: See Figure 725-61, Cable Substitution Hierarchy



Reprinted with permission from NFPA 70-2008 National Electrical Code®, copyright © 2008, National Fire Protection Association, Quincy, MA 02269. This reprinted material is not the complete and official position of the NFPA on the referenced subject, which is represented only by the standard in its entirety. National Electrical Code® and the NEC® are registered trademarks of the NFPA.



NEC/CEC Substitution Chart

Figure 760-154 (D), Cable Substitution Hierarchy

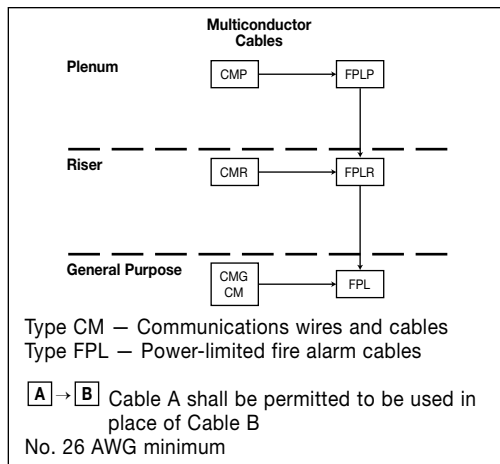

Article 760

Table 760-154 (D). Cable Uses and Permitted Substitutions

CABLE TYPE	USE	REFERENCES	PERMITTED SUBSTITUTIONS
			MULTICONDUCTOR
FPLP	Power-limited fire alarm plenum cable	760-154 (A)	CMP
FPLR	Power-limited fire alarm riser cable	760-154 (B)	CMP, FPLP, CMR
FPL	Power-limited fire alarm cable	760-154 (C)	CMP, FPLP, CMR, FPLR, CMG, CM

Note: See Figure 760-154 (D), Cable Substitution Hierarchy

Figure 820-154 (E), Cable Substitution Hierarchy

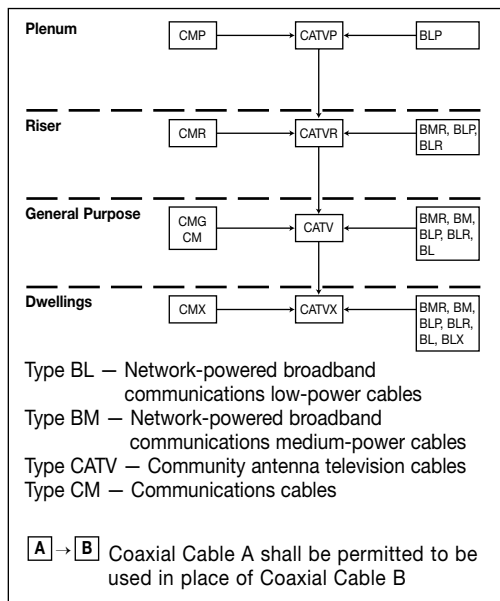

Article 820

Table 820-154 (E). Coaxial Cable Uses and Permitted Substitutions

CABLE TYPE	USE	REFERENCES	PERMITTED SUBSTITUTIONS
CATVP	Coaxial plenum cable	820-154 (A)	CMP, BLP
CATVR	Coaxial riser cable	820-154 (B)	CATVP, CMP, CMR, BMR, BLP, BLR
CATV	Coaxial general purpose cable	820-154 (C)	CATVP, CMP, CATVR, CMR, CMG, CM, BMR, BM, BLP, BLR, BL
CATVX	Coaxial cable, limited use	820-154 (C)	CATVP, CMP, CATVR, CMR, CATV, CMG, CM, BMR, BM, BLP, BLR, BL, BLX

Note: See Figure 820-154 (E), Cable Substitution Hierarchy

Agency Symbols



UL Listed Mark for the United States



CSA CMP



UL Listed Mark for Canada



CSA CMG



UL Listed Mark for Canada and the United States



CSA CMH



UL Recognized Component Mark for the United States



Underwriters Laboratories Inc.

NFPA 262 and CSA FT-6 Steiner Tunnel Fire Tests



TIA/EIA 568A Cat. 3



Underwriters Laboratories Inc.

UL Vertical Tray Flame Test



TIA/EIA 568B Cat. 5e & Cat. 6



Underwriters Laboratories Inc.

UL 1666 Riser Flame Test



California State Fire Marshal



IMSA



RoHS Compliant Directive 2002/95/EC

Agency Approval Index

AGENCY	PAGE(S)
CSA Type TEW	3, 5
CSA TR-64	2
CSA Type LVT.....	141
MIL-W-16878 TYPE B.....	37
MIL-W-76B.....	4
UL Type AWM.....	5-6
UL Type CL2.....	142
UL Type MTW.....	5-6
UL Type TFF	5
UL Type THW	6
UL Type 1007	2, 156
UL Type 1015	3
UL Type 1569	2
UL Type 2092	23, 35
UL Type 2093	23, 35, 159
UL Type 2094	23, 35, 38, 160-161
UL Type 2095	33, 36, 47, 159-160
UL Type 2106	23
UL Type 2107	23
UL Type 2448	74
UL Type 2464	9-14, 18-20, 23, 25, 30-31, 43-44, 53-54, 58, 60, 65-66, 68-71, 73, 75, 81
UL Type 2493	83-84
UL Type 2576	11-13, 60
UL Type 2587	14
UL Type 2717	58
UL Type 2835	58, 160
UL Type 2919	72, 76-78, 82
UL Type 2960	79

**Jacket
Color Code Chart**

CODE	COLOR
1	BLACK
2	WHITE
3	RED
4	ORANGE
5	YELLOW
6	GREEN
7	DARK BLUE
8	BROWN
10	GREY
13	PINK
16	LIGHT BLUE
19	PURPLE
77	WHT/BLK/BLU

Put-Ups

CODE	PACKAGING
R5/15	250' Spool
R8/18	500' Spool
21	1000' Spool
30	1000' Spoolless Pull-Pac® Carton
35	250' Reel
38	500' Reel
41	1000' Reel
44	2500' Reel
46	5000' Reel
85	250' Coil
99	Factory Reel
A3	Spool-Pac® 1000'

Put-Ups and Color Codes

PUT-UP CODES

PUT-UP CODE	PACKAGING	PUT-UP CODE	PACKAGING
03	3 ft Coax w/Connector HD	58	12 ft Sleeve w/connectors
06	6 ft Coax w/Connector HD	59	25 ft Sleeve w/connectors
11	50 ft Spool	60	Cord Hanked, coil w/cuff
12	100 ft Spool	61	Cord Set Box
13	Clamshell	62	Cord Set Bag
15	250 ft Spool	63	Cord Set Sleeve
18	500 ft Spool	64	50 ft Sleeve w/connectors
20	900 ft Spool	65	100 ft Sleeve w/connectors
21	1000 ft Spool	66	50 ft Cuff
24	2500 ft Spool	67	100 ft Cuff
25	500 ft Pull-Pac	68	3500 ft Reel
26	5000 ft Spool	69	Retail Spool-Pac
27	500 ft Pull-Pac	70	Cord Hanked, coil w/cuff
30	1000 ft Pull-Pac	73	Cord Set, long length
31	1000 ft Pull-Pac	74	12' Clamshell w/connectors
32	150 ft Reel	75	25' Clamshell w/connectors
33	100 ft Reel	76	50' Clamshell w/connectors
34	200 ft Coil	77	100' Clamshell w/connectors
35	250 ft Reel	78	15,000 ft Reel
36	300 ft Reel	79	8,000 ft Reel
38	500 ft Reel	80	B blister Pack w/connectors
39	500 Meter (1640')	85	250 ft Coil
40	Long Length Reel	86	500' Shrinkwrap coil
41	1000 ft Reel	88	12' Sleeve w/o connector
42	1500 ft Reel	89	25' Sleeve w/o connector
43	2000 ft Reel	90	50' Sleeve w/o connector
44	2500 ft Reel	91	75' Sleeve w/o connector
45	4000 ft Reel	92	100' Sleeve w/o connector
46	5000 ft Reel	93	Bulk Reel
47	7500 ft Reel	94	Display
48	10,000 ft Reel	96	Wiring Device, Skin Pack
49	1600 ft Reel	99	Factory Reel
50	1000 Meter (3280')	XX	Various Lengths
51	4500 ft Reel		
52	3000 ft Reel	A1	250 ft Spool-Pac
53	25 ft Cuff	A2	500 ft Spool-Pac
54	12 ft Clamshell	A3	1000 ft Spool-Pac
55	25 ft Clamshell	A4	2000 ft Spool-Pac
56	50 ft Clamshell	R5	250 ft Spool, Retail
57	100 ft Clamshell	R8	500 ft Spool, Retail

JACKET COLOR CODES

COLOR CODE	JACKET COLOR	COLOR CODE	JACKET COLOR
00	Uninsulated	46	Orange/Black
01	Black	47	Yellow/White
02	White	48	Yellow/Black
03	Red	49	Blue/White
04	Orange	50	Blue/Black
05	Yellow	56	Black w/White Trace
06	Green	62	Silver Gray (Lt Gray)
07	Dark Blue	66	Light Green
08	Brown	67	Lime Green
09	Maroon	68	Birch
10	Gray	69	Maple
11	Antique Gold	70	Walnut
12	Ivory	71	Wrought Iron
13	Pink	72	Copper
14	Light Green	73	White/Black/Red
15	Clear Gold	74	White/Black/Orange
16	Light Blue	75	White/Black/Yellow
17	Beige	76	White/Black/Green
18	Light Brown	77	White/Black/Blue
19	Purple	78	White/Black/Brown
20	Clear Silver	79	White/Black/Violet
21	Light Purple	80	White/Black/Gray
22	Neon Green	81	Black/Red/White
23	Mint Green	82	Orange/Green/Black
24	Raspberry	86	Natural
25	Gold	88	Tan
31	White/Black	90	Clear
33	White/Red	91	Clear Brown
34	White/Orange	92	Clear Blue
35	White/Yellow	93	Clear Red
36	White/Green	96	Twisted Cond. No Jkt
37	White/Blue	97	1 Stripe
38	White/Brown	98	2 Stripes
39	White/Violet	99	Assorted Colors
40	White/Gray		
41	Red/Green		
42	Green/White		
43	Blue/Red		
44	Blue/White		
45	Orange/Red		

CSA FIRE ALARM COLOR CODE CHART

CONDUCTOR	COLOR	CONDUCTOR	COLOR
1st	Black	16th	White w/Brown Stripe
2nd	Red	17th	Green w/Brown Stripe
3rd	Green	18th	Yellow w/Brown Stripe
4th	Blue	19th	White w/Orange Stripe
5th	Brown	20th	Black w/Orange Stripe
6th	Orange	21st	Red w/Orange Stripe
7th	Black w/White Stripe	22nd	Green w/Orange Stripe
8th	Red w/White Stripe	23rd	Brown w/Orange Stripe
9th	Green w/White Stripe	24th	White w/Blue Stripe
10th	Yellow w/White Stripe	25th	Red w/Blue Stripe
11th	Red w/Black Stripe	26th	Yellow w/Blue Stripe
12th	Green w/Black Stripe	27th	Brown w/Blue Stripe
13th	Yellow w/Black Stripe	28th	Black w/Red Stripe
14th	Green w/Red Stripe	29th	White w/Red Stripe
15th	Yellow w/Red Stripe	30th	Brown w/Red Stripe

PAIR	COLOR	PAIR	COLOR
1st	Black & Red	16th	White & Brown
2nd	Black & White	17th	White & Orange
3rd	Black & Grey	18th	Blue & Yellow
4th	Black & Blue	19th	Blue & Brown
5th	Black & Yellow	20th	Blue & Orange
6th	Black & Brown	21st	Brown & Yellow
7th	Black & Orange	22nd	Brown & Orange
8th	Black & Purple	23rd	Purple & Red
9th	Red & White	24th	Purple & White
10th	Red & Blue	25th	Purple & Blue
11th	Red & Yellow	26th	Purple & Brown
12th	Red & Brown	27th	Purple & Yellow
13th	Red & Orange		
14th	White & Blue		
15th	White & Yellow		



Applications Index

A	
Access control	114, 131-133
Addressable Fire Alarm Systems	125-128
Alliance Ham/CB and TV rotors compatibility	139
Amplifiers	152, 169
Analog video	102, 115, 167
Analog/digital video	99, 102, 115
Analog/digital video broadcast-grade monitors	93
Annunciator systems	141-143
Audio	25, 39, 134-137, 159
Audio components	166-168
Audio interconnects	40-41
Audio systems	15-17, 25, 27-28, 45-46, 148, 156, 172, 175
Audio/image/video products	183
Automatic valve control systems	22
B	
Background music	16-17, 27-28, 134-137
Basses	169
Bell systems	141-143
Bi-amp speakers	152-153
Broadcast	94, 100, 107-108, 112
Broadcast and sound systems	23, 25, 29-30
Broadcast and studio	35, 38, 40-41
Broadcast and studio requirements	21
Broadcast and studio use	172, 175
Broadcast digital video	96-98
Broadcast grade	105-106
Broadcast-grade headend	92
Broadcast/HDTV	88-93, 96-99, 107-108
Broadcast/Serial Digital Interface (SDI)	92, 106-107
Broadcast-grade Serial Digital Interface (SDI)	99
Burglar alarms	22, 32, 65-66, 116-121, 123, 129, 141-143
Business machines	22, 32, 65-66
C	
Cable tray installations	22, 32
CAD/CAM systems	78
Card readers	114
Cash registers	22, 32, 65
Cat 5e ScTP	163
Cat 5e UTP	163
CATV	86-92, 96-99, 101-106, 110-115, 150
CATV/headend	92
CCTV	86-88, 90-92, 96-99, 101-102, 104-105, 110, 114-115, 162, 177
Commercial broadcast facilities	158
Communication and audio system	148, 172, 175
Communication and control	161
Communication circuits	46
Communications	66, 114, 116-129, 159-160
Computer and computer interconnections	23-24, 26, 29, 31, 60, 68-69, 78
Computer interconnections	24, 31, 60, 68-69, 78
Computer/networks	109
Computers	29, 39, 43-44, 49-51, 53-54, 57-59, 62-64, 70-77, 79-84, 95, 112, 183-184
Console board equipment	166-168
Control circuits	9, 11-21, 24, 26-28, 31, 39-41, 43-45, 48-64, 68-84, 134-138, 152-153, 172, 175, 185
Cue line systems	177
D	
Data and signal transmission	24
Data transmission	31, 43-44, 53-54, 60, 68-71, 73-77, 79, 95, 100, 112, 163
DBS	86, 90-92, 115
Digital audio	147-148, 151, 157, 166
Digital audio interfaces	153
Digital data transport	183
Digital video cameras/displays/recorders	183
Digital/audio	147-148, 151-157, 166
Direct broadcast satellite	90
Direct burial	26, 89, 97-98, 104, 139-140, 164-165
Disc arrays	183-184
Door bells	141-143
Door control	132-133
Drop cable	88, 91-92, 96-99, 103
E	
EIA RS-232 circuits	48, 52, 55-58
EIA RS-232 systems	11-14, 18-20, 30-31, 43-44, 54-56, 68-73, 75, 77-79
EIA RS-422 circuits	55-56, 77, 79, 83
EIA RS-423 systems	72, 78
Effects pedals	169
Electronic instrumentation control systems	47
EMI isolated circuits for instrumentation	159-160
Energy management systems	21
Excellent shielding for noise reduction	34-38
External wiring of machinery	5-6
F	
Fire alarm control	21
Fire alarm systems	122, 124-129
Fire protective circuits	117-121, 123
FM broadcast	88, 91
G	
General-purpose audio applications	170
Good flexibility	23, 29-31, 34, 36-37, 53-54, 70-72, 75-79
Guitars	169

Applications Index

H

HDTV	86-93, 96-99, 107-108, 115
Heating and air conditioning installations	141-143
Helical binding or overall jacketing	163
Hi-fi and stereo speaker wire	156-157
High speed computer interconnects	78
High speed computers	72, 83-84
High speed solid state circuits for	
low-voltage applications	182
High-end microphones	148
High-impedance microphones	172, 175
Home entertainment	147-148, 151-156, 170
Home theater	114, 116, 147-148, 151-153, 156

I

Industrial control systems	32
Industrial equipment	43-44, 53-54, 58-59, 70-84
Industrial equipment control	23, 29-31, 60, 68-69
IEEE 802.3 and ISO/IEC 8802.3	
10 Base 5 LAN computer cables	95
IEEE 802.3 and ISO/IEC 8802.3	
10 Base 2 computer cables	95
Instrumentation	150, 159-161
Instrumentation and control use	46
Instrumentation systems	25, 47
Intercom systems	16-17, 22, 27-28, 32, 47, 65-66, 138, 141-143
Intercoms	9, 11-14, 18-20, 116
Interconnection components	166-168
Internal telephones	11-14, 18-20
Internal wiring, electrical/electronic equipment,	
panels/meters	2-5
In-wall speakers	147, 151-155
Irrigation systems	22

J

Jukeboxes	156-157
-----------	---------

K

Keyboards and other instruments to amplifiers, mixers, and effects pedals	169
---	-----

L

LAN and data transmission	100
LAN and data transmission computer cables	95
LAN cable	90
Line level microphone	167-168
Line level signals	167-168
Local area network	101-104
Low capacitance applications	35, 38, 72, 74, 83-84, 166-169
Low capacitance requirements	56, 76-77, 79
Low cost alternative to laminated bus bars	182
Low inductance DC applications	182

Low signal distortion data requirements	78
Low-voltage installations	141-143
Low-voltage power distribution, electronic	
and data processing equipment	182
Low-impedance microphones	172, 174-175
Low-voltage golf course satellite sprinkler control	140

M

MATV	86, 88-89, 96-99, 101-106, 110, 115
Mixers	169
Monitor applications	93, 107-108
Monitor systems	177
Monitor/VDT display	101-104
Motor and transformer lead	5-6
Multiple cable pulls	163
Musical instruments	170

N

Noise reduction shielding	34-38
Non QPL	4, 37
Not for in-wall use	156-158

O

Optical fiber cables	163
Oscillators	7
Outdoor installations	139
Outdoor rated	138-140, 176
Outdoor signal processing gear	169
Outdoor use	164-165

P

Parallel or serial transmission	184
Personal computers	183-184
Petrochemical control systems	66
Petrochemical refineries	32
Plenum versions	163
Point-of-sale systems	61
Point-to-point wiring	2-5
Power-limited circuits	22, 32, 65-66
Power-limited control circuits	16-17, 27-28, 48, 52, 55, 61, 134-137
Precision video – analog/digital	105-106
Primary power distribution, electronic	
and data processing equipment	182
Process control and instrumentation	15, 26, 39, 45, 48-52, 55-57, 61-64
Programmable Logic Controllers (PLC)	112
Public address systems	9-14, 18-20
Pull boxes	122, 124-128

R

Radio station components, interconnection and audio	166-168
Radio transmitters	33-34, 36, 171, 173
Radios	33-34, 36, 171, 173

Applications Index

Recording studios 33-34, 36, 158, 166-168, 171, 173
 Recording studios and sound stages 23, 29-30
 Recording studio components,
 interconnection and audio 166-168
 Remote control circuits 9, 11-15, 18-20, 26, 39, 45,
 48-52, 55-57, 61-64, 138, 152-153
 Remote control for studio equipment 37
 Remote control systems 177
 Remote control units 141-143
 Residential sprinkler solenoid control 140
 REX 132-133
 RF shielding 24, 33-38, 164, 171, 173
 RF signal transmission 88, 91, 94, 96-111
 RG6 video/data quad shield coax 163
 RGB video 115, 162
 Riser versions 163
 Rotor antenna controls 139
 RS-232 circuits 48, 52, 55-56
 RS-232 systems 11-14, 18-20, 30-31, 43-44,
 53-54, 68-73, 75, 77-79
 RS-422 circuits 55-56
 RS-423 systems 72, 78

S

Satellite actuator control 101
 Satellite receivers 115
 Secondary power distribution, electronic
 and data processing equipment 182
 Security systems 132-133, 152-153
 Serial Digital Interface (SDI) 87, 92, 99, 107
 Shielded cable 24, 164
 Shielded power supplies 148, 172, 175
 Shielding, Fire Wire 183-184
 Shielding, noise reduction 34-38
 Shielding, SCSI 184
 Shielding, USB 184
 Signal isolation, total 61-64, 80-84
 Signal systems 141-143
 Smoke detectors 115, 117, 121-128
 Sound system installations 166-168
 Sound systems 23, 25, 29-30, 33-38,
 47, 116, 171, 173

Speaker extension service 138
 Special audio 159-161
 Stereo systems 148, 151-155
 Studio use 148, 172, 175
 Suggested voltage rating: 1000 volts 174
 Suggested voltage rating: 1000 volts (MIL-W 76B) 4
 Suggested voltage rating: 150 volts 16-17, 27-28, 52, 138
 Suggested voltage rating: 200 volts 139
 Suggested voltage rating: 30 volts 72, 74, 76-79, 82
 Suggested voltage rating: 300 or 600 volts 18-20, 23,
 29-31, 53-54, 59
 Suggested voltage rating: 300 volts 2, 9-15, 22, 24-26, 32-36,
 38-41, 43-51, 55-58, 60-66, 68-71, 73,
 75, 80-81, 83-84, 117-129, 134-138,
 148, 154, 159, 161, 171-173, 175, 185
 Suggested voltage rating: 350 volts 21, 164-165
 Suggested voltage rating: 600 volts 3, 37
 Suitable for EIA RS-232 and RS-423
 CAD/CAM applications 72
 Suitable for EIA RS-232 applications 11-14, 18-20, 30-31,
 43-44, 53-54, 68-73, 75, 77-79
 Suitable for EIA RS-422 applications 77, 79
 Suitable for EIA RS-422 CAD/CAM applications 83
 Suitable for EIA RS-485 applications 76

T

Television station components,
 interconnection and audio 166-168
 Test equipment 7
 Thermostat control 141-143
 Thicknet/trunk cable 95
 Touch-plate systems 141-143
 Tray cable installations 65-66
 TV broadcast 177
 TV cameras 177

V

Video 88-93, 96-98
 Video and audio interconnecting cables 172, 175
 Video interconnect 38, 38
 Video – analog/digital 99, 102, 105-108
 Voice communications 117-129

Belden-to-General Cable Carol® Brand Cross Reference Index

BELDEN PART NUMBER	GENERAL CABLE/ CAROL PART NUMBER	PAGE NUMBER
1030A	C0456A	32
1031A	C0457A	32
1032A	C0454A	32
1186A	C5784	103
1189A	C5785	89
1189AP	C3525	91
1190A	C5804	89
1242A	E1001S	134
1266A	E2022S	135
1306SB	C8029	91
1307A	C1804	153
1309A	C1802	153
1426A	C1142	101
1502A	495023	106
1502P	C8125	185
1503A	C0600A	73
1505A	395025	106
1506A	495023	106
1508A	C2513A	23
1513A	C5776	88
1523A	C5039	97
1523AP	C3528	97
1525A	C5039	97
1530A	C5776	88
1583A	CR5	N/A
1585A	CP5	N/A
1617A	C5044	97
1694A	395011	92
1694SB	C5814	90
1695A	495025	92
1841A	C5822	90
1855A	395031	107
1861A	C1004A	154
1883A	C0600A	73
1884A	C5889	89
1912A	740512	167
19352	86013	N/A
3105A	C7112A	66
3107A	C7114A	66
3108A	C7116A	66
5000FE	E2062S	135
5000UE	E1062S	134
5002UE	E1064S	134
5020FL	E2542S	119
5020UL	E1532S	117
5100FE	E2052S	135
5100UE	E1052S	134
5102A	E1054S	134
5102UE	E1054S	134
5102UP	C1803	153
5120FJ	C0475	126
5120FL	E2532S	119
5120LL	E2406S	117
5120UL	E1522S	117

BELDEN PART NUMBER	GENERAL CABLE/ CAROL PART NUMBER	PAGE NUMBER
5122FL	E2534S	119
5122UL	E1524S	117
513945	395058	99
5200FE	E2042S	135
5200UE	E1042S	134
5200UP	C1804	153
5201FE	C2537A	23
5201UE	E1043S	134
5202FE	E2244S	137
5202UE	E1044S	134
5220FL	E2522S	119
5220LL	E2404S	135
5220UL	E1512S	117
5222FL	E2524S	119
5222UL	E1514S	117
5300FE	E2032S	135
5300UE	E1032S	134
5301FE	E2033S	135
5301UE	E1033S	134
5302FE	E2034S	135
5302UE	E1034S	134
5304FE	E2036S	135
5304UE	E1036S	134
5306FE	E2038S	135
5306UE	E1038S	134
5308UE	E1040S	134
5309UE	E1041S	134
5300UE	E1032S	134
5320FE	E2030S	135
5320FL	E2502S	119
5320LL	E2402S	117
5320UE	E1030S	134
5320UL	E1502S	117
5321FL	E2503S	119
5321UL	E1503S	117
5322FL	E2504S	119
5322UL	E1504S	117
5324UL	E1506S	117
5341A	C0560A	66
5342UE	C6103A	44
5400FE	E2022S	135
5400UE	C6351A	13
5401FE	E2023S	135
5401UE	E1023S	134
5402FE	E2024S	135
5402UE	E1024S	134
5400UE	E1022S	134
543945	C1142	101
549945	C8028	104
5500FE	E2002S	135
5500UE	E1002S	134
5501FE	E2003S	135
5501UE	E1003S	134
5502FE	E2004S	135



This cross reference guide should be used in conjunction with the product information in our catalog or on our website. It should be used for suggested alternative items which are functionally equal. Constructional differences are not indicated. General Cable is not responsible for variances due to competitor and industry constructional changes or agency updates.



Belden-to-General Cable Carol® Brand Cross Reference Index

BELDEN PART NUMBER	GENERAL CABLE/ CAROL PART NUMBER	PAGE NUMBER
5502UE	E1004S	134
5504FE	E2006S	135
5504UE	E1006S	134
5506FE	E2008S	135
5506UE	E1008S	134
5508FE	E2010S	135
5508UE	E1010S	134
5509FE	E2012S	135
5509UE	E1012S	134
5500UE	E1002S	134
5520FE	E2000S	135
5520UE	E1000S	134
5522UE	E1001S	134
5522UL	E1484S	117
5545UE	C6106A	44
5562FE	C0722A	73
558AFS	4ERS4S	133
558GMS	4ERS1S	133
6000UC	C3129	17
6000UE	E3062S	136
6020FL	E3632S	123
6020UL	E3532S	121
6100FE	E2252S	137
6100UE	E3052S	136
6100UF	C3128	17
6102UE	E3054S	136
6120FL	C3174	128
6120UL	E3522S	121
6122FL	E3624S	123
6122UL	E3524S	121
6200FE	E2242S	27
6200UE	E3042S	17
6201FE	E2243S	137
6201UE	E3043S	136
6202FE	C3341	27
6202UE	E3044S	136
6220FL	E3612S	123
6220UL	E3512S	121
6222FL	E3614S	123
6222UL	E3514S	121
6300FE	E2202S	137
6300UE	E3032S	136
6301FE	E2203S	137
6301UE	C3120	17
6302FE	E2204S	137
6302UE	C3113	17
6304FE	E2206S	137
6304UE	C3121	17
6306FE	E2208S	137
6306UE	C3122	17
6320FE	E2200S	137
6320FL	E3602S	123
6320UE	E3030S	136
6320UL	E3502S	121

BELDEN PART NUMBER	GENERAL CABLE/ CAROL PART NUMBER	PAGE NUMBER
6321FL	E3603S	123
6321UL	E3503S	121
6322FL	E3604S	123
6322UL	E3504S	121
6324UL	E3506S	121
633948	495035	92
6400FE	E2122S	137
6400UE	E3022S	136
6401FE	E2123S	137
6401UE	E3023S	136
6402FE	E2124S	137
6402UE	E3024S	136
643948	495028	105
649948	C8030	101
6500FE	E2102S	137
6500UE	E3002S	136
6501FE	E2103S	137
6501UE	E3003S	136
6502FE	E2104S	137
6502UE	E3004S	136
6504FE	E2106S	137
6504UE	E3006S	136
6506FE	E2108S	137
6506UE	E3008S	136
6520FE	E2100S	137
6520UE	E3000S	136
6522UE	E3001S	136
6541FE	C3205	48
6543A	C3151	48
6545FE	C3208	48
658AFS	4EPL4S	132
658GMS	4EPL1S	132
7731A	395029	99
7732A	495027	99
7987P	E3842S	162
7987R	E1842S	162
7989P	E3843S	162
7989R	E1843S	162
8102	C0515A	78
8103	C0516A	78
8104	C0517A	78
8105	C0518A	78
8106	C0519A	78
8107	C0520A	78
8108	C0521A	78
8110	C0522A	78
8112	C0523A	78
8115	C0524A	78
8118	C0525A	78
8125	C0526A	78
8162	C0924A	84
8163	C0925A	84
8164	C0926A	84
8205	C6351A	13

This cross reference guide should be used in conjunction with the product information in our catalog or on our website. It should be used for suggested alternative items which are functionally equal. Constructional differences are not indicated. General Cable is not responsible for variances due to competitor and industry constructional changes or agency updates.



Belden-to-General Cable Carol® Brand Cross Reference Index

BELDEN PART NUMBER	GENERAL CABLE/ CAROL PART NUMBER	PAGE NUMBER
8212	C1102	101
8213	C5025	96
8214	C1198	94
8216	C1156	110
8218	C1158	105
8219	C1188	100
8221	C1135	101
82241	C3500	104
82248	C3523	91
82262	C3520	109
8228	C5760	88
8237	C1154	94
8240	C1166	100
82442	E3002S	136
8248	C3521	91
82489	C8102	15
82503	C8113	51
8259	C1178	100
8261	C1160	96
8262	C1155	100
8263	C1106	101
82641	C8127	51
8267	C1176A	111
82723	C8105	62
82729	C8134	62
82740	C8122	45
82760	C8123	51
82761	C8126	51
82777	C8131	62
82778	C8133	62
82842	C8129	57
8302	C0650A	75
8303	C0651A	75
8304	C0652A	75
8305	C0653A	75
8306	C0654A	75
8307	C0655A	75
8308	C0656A	75
8310	C0658A	75
8312	C0660A	75
83206	C8101	49
8325	C0663A	75
8332	C0620A	75
8333	C0621A	75
8334	C0622A	75
8335	C0623A	75
8336	C0624A	75
8337	C0625A	75
8340	C0628A	75
8342	C0630A	75
83503	C8115	39
83653	C8107	39
83654	C8110	39
83656	C8120	39

BELDEN PART NUMBER	GENERAL CABLE/ CAROL PART NUMBER	PAGE NUMBER
83702	C8111	39
83703	C8119	39
83706	C8108	39
8412	C1302	40, 172
8418	C1313	40
8422	C1322A	174
8423	C1304	40
8424	C1305	40
8425	C1308	40
8426	C1310	40
8427	C1312	40
8428	C1202	41, 175
8437	C2676A	34
8441	C2677A	34
8442	C6348A	12
8443	C4062A	12
8444	C4063A	12
8445	C4064A	12
8446	C4081A	10
8447	C4082A	10
8448	C4083A	10
8449	C4084A	10
8450	C2515A	23
8451	C2516A	23
8456	C4071A	12
8457	C4067A	12
8458	C4073A	12
8459	C4076A	12
8460	C7102A	156
8461	C2830A	13
8465	C2420A	13
8466	C2412A	13
8467	C2421A	13
8468	C2423A	13
8469	C2422A	13
8471	C2405A	14
8473	C2409A	14
8477	C2410A	14
8486	C2754A	9
8488	C1130	139
8489	C2404A	13
8520	C7610A	4
8521	C7608A	4
8522	C7606A	4
8523	C7604A	4
8524	C7602A	4
8525	C7600A	4
8527	C7611A	66
8612	C3521	91
8618	C2537A	23
8619	C2424A	13
8620	C2425A	14
8621	C2426A	14
8622	C2427A	14

**CAROL
BRAND**

This cross reference guide should be used in conjunction with the product information in our catalog or on our website. It should be used for suggested alternative items which are functionally equal. Constructional differences are not indicated. General Cable is not responsible for variances due to competitor and industry constructional changes or agency updates.

 **General Cable**

Belden-to-General Cable Carol® Brand Cross Reference Index

BELDEN PART NUMBER	GENERAL CABLE/ CAROL PART NUMBER	PAGE NUMBER
8623	C2428A	14
8624	C2429A	14
8627	C2430A	14
8628	C2431A	14
8641	C2513A	23
8649	C1360	156
8661	C2426A	14
8690	C6103A	44
8691	C6106A	44
8692	C6109A	44
8718	C2539A	23
8719	C2536A	23
8720	C2538A	23
8722	C1331A	160
8723	C1352A	58
8723SB	C1352ACS	N/A
8724	C1340A	160
8725	C1368A	80
8728	C1353A	58
8729	C7110A	N/A
8732	C1338A	161
8735	C2678A	36
8737	C2882A	33
8740	C4008A	9, 43
8741	C4010A	43
8742	C4014A	43
8743	C4017A	43
8747	C6017A	43
8748	C6019A	43
8749	C6026A	43
8751	C6451A	47
8757	C4015A	43
8759	C2888A	33
8760	C2534A	23
8761	C2514A	23
8762	C2524A	23
8763	C1333A	159
8767	C6035A	81
8768	C6036A	81
8769	C6045A	82
8770	C2535A	23
8771	C2526A	23
8772	C2525A	23
8773	C6046A	82
8774	C6042A	82
8775	C6043A	82
8776	C6044A	82
87760	C8104	49
87761	C8103	49
8777	C6040A	82
8777SB	C6040ACS	N/A
8778	C6041A	82
8780	C2895A	33
8782	C1356	156

BELDEN PART NUMBER	GENERAL CABLE/ CAROL PART NUMBER	PAGE NUMBER
8786	C1345A	159
8790	C2892A	33
8791	C2768A	33
8795	C4408	138
88102	C8118	50
88723	C8112	63
88760	C8101	49
88761	C8109	49
88770	C8106	26
8898	C1318	7
8899	C1321	7
8916	C2105A	3
8917	C2104A	3
8918	C2103A	3
8919	C2102A	3
8920	C2101A	3
89418	C8114	26
88778	C8132	63
89729	C8128	64
89740	C8116	45
89841	C8117	57
9011	C5034	96
9066	C5804	89
9116	C5775	88
9116P	C3524	91
9116R	C5886	88
9116SB	C5775ACS	N/A
9117	C5802	89
9151	C1000A	154
9151SB	C2520	24
9154	E2022S	135
9155	C1343A	160
9156	C6118A	44
9157	C6119A	44
9159	C6120A	44
9161	C6121A	44
9182	C8014	112
9201	C1117	100
9207	C8000	112
9209	395031	107
9248	C5778	91
9258	C1108A	94
9259	C1103	101
9265	C8025	102
9269	C1164	109
9291	C5770	103
9302	C1670A	46
9305	C1676A	46
9306	C1671A	46
9309	C1672A	46
9312	C0460A	32
9314	C0458A	32
9315	C1673A	46
9316	C0456A	32

This cross reference guide should be used in conjunction with the product information in our catalog or on our website. It should be used for suggested alternative items which are functionally equal. Constructional differences are not indicated. General Cable is not responsible for variances due to competitor and industry constructional changes or agency updates.



Belden-to-General Cable Carol® Brand Cross Reference Index

BELDEN PART NUMBER	GENERAL CABLE/ CAROL PART NUMBER	PAGE NUMBER
9318	C0454A	32
9320	C0452A	32
9322	C0450A	32
9328	C0570A	65
9329	C0571A	65
9330	C0572A	65
9331	C0573A	65
9332	C0574A	65
9333	C0575A	65
9363	C0451A	32
9364	C0453A	32
9365	C0455A	32
9366	C0457A	32
9367	C0459A	32
9368	C0584A	65
9369	C0585A	65
9388	C0586A	65
9389	C0587A	65
9390	C0588A	65
9391	C0589A	65
9392	C0590A	65
9397	C1226A	173
9402	C7106A	58
9406	C1350A	60
9407	C0431A	22
9408	C0433A	22
9409	C0435A	22
9410	C0437A	22
9411	C0439A	22
9412	C0441A	22
9414	C6010A	43
9418	C2543A	25
9421	C4065A	12
9423	C4070A	12
9430	C4088A	12
9431	C4075A	12
9432	C4077A	12
9433	C4078A	12
9434	C4079A	12
9438	C7108A	7
9439	C6356A	13
9444	C6353A	13
9445	C6355A	13
9451	C2520A	24
9451P	C8124	51
9451SB	C2520A	24
9452	C1228A	171
9455	C6357A	13
9457	C6360A	13
9458	C6358A	13
9460	C2521A	24
9461	C2518A	24
9462	C7104A	46
9464	C2519A	24

BELDEN PART NUMBER	GENERAL CABLE/ CAROL PART NUMBER	PAGE NUMBER
9491	C0432A	22
9492	C0434A	22
9493	C0436A	22
9494	C0438A	22
9495	C0440A	22
9501	C0600A	73
9502	C0601A	73
9503	C0602A	73
9504	C0603A	73
9505	C0604A	73
9506	C0605A	73
9507	C0606A	73
9508	C0607A	73
9509	C0608A	73
9510	C0609A	73
9512	C0550A	66
9513	C0551A	66
9514	C0552A	66
9515	C0610A	73
9516	C0553A	66
9519	C0611A	73
9520	C0554A	66
9521	C0555A	66
9524	C0556A	66
9525	C0612A	73
9533	C0741A	68
9534	C0742A	68
9535	C0753A	68
9536	C0743A	68
9537	C0754A	68
9538	C0744A	68
9539	C0755A	68
9540	C0745A	68
9541	C0746A	68
9542	C0747A	68
9543	C0748A	68
9544	C0749A	68
9545	C0750A	68
9546	C0751A	68
9552	C0560A	66
9553	C0561A	66
9554	C0562A	66
9556	C0563A	66
9559	C0564A	66
9565	C0566A	66
9608	C0951A	70
9609	C0952A	70
9610	C0953A	70
9611	C0954A	70
9612	C0955A	70
9613	C0956A	70
9614	C0957A	70
9615	C0958A	70
9616	C0959A	70

**CAROL
BRAND**

This cross reference guide should be used in conjunction with the product information in our catalog or on our website. It should be used for suggested alternative items which are functionally equal. Constructional differences are not indicated. General Cable is not responsible for variances due to competitor and industry constructional changes or agency updates.

 **General Cable**

Belden-to-General Cable Carol® Brand Cross Reference Index

BELDEN PART NUMBER	GENERAL CABLE/ CAROL PART NUMBER	PAGE NUMBER
9617	C0961A	70
9620	C2434A	14
9621	C2435A	14
9622	C2436A	14
9623	C2437A	14
9626	C2433A	13
9637	C0948A	70
9708	C1357	156
9712	C1362	156
9716	C1358	156
9717	C1361	156
9718	C1363	156
9721	C2443A	14
9728	C0912A	83
9729	C0910A	83
9730	C0911A	83
9731	C0913A	83
9732	C0914A	83
9733	C0915A	83
9734	C0916A	83
9735	C0917A	83
9740	C6101A	44
9742	C6111A	44
9744	C6010A	43
9745	C6014A	43
9746	C6015A	43
9747	C6023A	43
9768	C6059A	82
9769	C6060A	82
9770	C2517A	23
9773	C6047A	82
9774	C6048A	82
9775	C6049A	82
9776	C6050A	82
9777	C6051A	82
9791	C0533A	72
9794	E1004S	134
9802	C2509A	164
9803	C2510A	164
9804	C0804A	79
9805	C0805A	79
9806	C0806A	79
9807	C0807A	79
9808	C0808A	79
9809	C0809A	79
9812	C0812A	79
9829	C0829A	77
9830	C0830A	77
9831	C0831A	77
9832	C0832A	77
9833	C0833A	77
9835	C0835A	77
9836	C0836A	77
9839	C0839A	77

BELDEN PART NUMBER	GENERAL CABLE/ CAROL PART NUMBER	PAGE NUMBER
9841	C4841A	76
9842	C4842A	76
9843	C4843A	76
9844	C4844A	76
9862	C1162	109
9863	C8000	112
9873	C6052A	82
9874	C6053A	82
9875	C6054A	82
9877	C6056A	82
9879	C6058A	82
9883	C6061A	165
9886	C6062A	165
9890	C2511A	164
9899	C1320A	7
9910	C2107A	3
9912	C2106A	3
9913	C1180	94
9916	C2065A	2
9918	C2064A	2
9919	C2040A	2
9921	C2016A	2
9923	C2015A	2
9924	C2100A	3
9925	C0680A	72
9927	C0681A	72
9929	C0682A	72
9931	C0683A	72
9932	C0684A	72
9933	C0685A	72
9934	C0686A	72
9935	C0687A	72
9936	C0688A	72
9939	C0971A	71
9940	C0972A	71
9941	C0973A	71
9942	C0974A	71
9943	C0975A	71
9944	C0976A	71
9945	C0977A	71
9946	C0978A	71
9947	C0979A	71
9948	C0981A	71
9990	C6065A	82
9991	C6066A	82
9992	C6067A	82

This cross reference guide should be used in conjunction with the product information in our catalog or on our website. It should be used for suggested alternative items which are functionally equal. Constructional differences are not indicated. General Cable is not responsible for variances due to competitor and industry constructional changes or agency updates.



Part Number Index

CATALOG NUMBER	PAGE	CATALOG NUMBER	PAGE	CATALOG NUMBER	PAGE	CATALOG NUMBER	PAGE
4EPL1S	132	76822	5	740501	167	C0438A	22
4EPL4S	132	76832	5	740504	167	C0439A	22
4ERS1S	133	76843	5	740508	167	C0440A	22
4ERS4S	133	76954	6	740512	167	C0441A	22
05091	141	76994	6	740516	167	C0444A	22
05092	141	395011	92	740520	167	C0450A	32
05093	141	395011-3	93	740528	167	C0451A	32
05094	141	395011-4	93	740542	167	C0452A	32
05095	141	395011-5	93	740552	167	C0453A	32
05096	141	395025	106	740601	166	C0454A	32
05097	141	395025-3	107	740604	166	C0455A	32
05098	141	395025-4	107	740608	166	C0456A	32
05099	141	395025-5	107	740612	166	C0457A	32
05481	142	395025-10	107	740616	166	C0458A	32
05482	142	395027	110	740620	166	C0459A	32
05483	142	395029	99	740701	168	C0460A	32
05484	142	395031-3	107	740704	168	C0471	125
05485	142	395031-5	107	740706	168	C0472	126
05486	142	395035-3	108	740708	168	C0473	125
05487	142	395035-4	108	740709	168	C0474	126
05488	142	395035-5	108	740712	168	C0475	126
05489	142	395058	99	740716	168	C0476	126
05581	142	397001	95	740720	168	C0485	125
05582	142	495015	99	740728	168	C0486	125
05583	142	495016	99	740742	168	C0491	125
05584	142	495023	106	740752	168	C0492	125
05585	142	495025	92	742605	177	C0494	126
05586	142	495027	99	742608	176	C0495	126
05587	142	495028	105	743601	169	C0496	126
05588	142	495035	92	743602	169	C0497	126
05589	142	495036	92	743603	169	C0515A	78
05782	143	497001	95	743604	169	C0516A	78
05783	143	574608	176	743605	169	C0517A	78
05784	143	710010	163	743701	170	C0518A	78
05785	143	710011	163	743704	170	C0519A	78
05786	143	710017	163	743705	170	C0520A	78
05788	143	710018	163	743706	170	C0521A	78
23804-18-01	140	710021	163	743707	170	C0522A	78
23805-18-01	140	710022	163	810021	163	C0523A	78
23807-18-01	140	710023	163	810022	163	C0524A	78
23810-18-01	140	710024	163	810023	163	C0525A	78
23815-60-01	140	740002	158	810024	163	C0526A	78
23817-60-01	140	740004	158	C0431A	22	C0530A	72
23824-60-01	140	740102	158	C0432A	22	C0531A	72
23825-60-01	140	740104	158	C0433A	22	C0532A	72
23827-60-01	140	740202	158	C0434A	22	C0533A	72
76502	5	740204	158	C0435A	22	C0534A	72
76512	5	740302	158	C0436A	22	C0535A	72
76812	5	740304	158	C0437A	22	C0536A	72

Part Number Index

CATALOG NUMBER	PAGE	CATALOG NUMBER	PAGE	CATALOG NUMBER	PAGE	CATALOG NUMBER	PAGE
C0537A	72	C0630A	75	C0764A	69	C0924A	84
C0538A	72	C0650A	75	C0765A	69	C0925A	84
C0550A	66	C0651A	75	C0766A	69	C0926A	84
C0551A	66	C0652A	75	C0767A	69	C0939A	70
C0552A	66	C0653A	75	C0768A	69	C0940A	70
C0553A	66	C0654A	75	C0780A	69	C0941A	70
C0554A	66	C0655A	75	C0781A	69	C0942A	70
C0555A	66	C0656A	75	C0782A	69	C0943A	70
C0556A	66	C0658A	75	C0783A	69	C0944A	70
C0560A	66	C0660A	75	C0784A	69	C0945A	70
C0561A	66	C0663A	75	C0785A	69	C0946A	70
C0562A	66	C0680A	72	C0786A	69	C0947A	70
C0563A	66	C0681A	72	C0787A	69	C0948A	70
C0564A	66	C0682A	72	C0788A	69	C0951A	70
C0566A	66	C0683A	72	C0804A	79	C0952A	70
C0570A	65	C0684A	72	C0805A	79	C0953A	70
C0571A	65	C0685A	72	C0806A	79	C0954A	70
C0572A	65	C0686A	72	C0807A	79	C0955A	70
C0573A	65	C0687A	72	C0808A	79	C0956A	70
C0574A	65	C0688A	72	C0809A	79	C0957A	70
C0575A	65	C0720A	73	C0810A	79	C0958A	70
C0584A	65	C0721A	73	C0812A	79	C0959A	70
C0585A	65	C0722A	73	C0829A	77	C0960A	70
C0586A	65	C0723A	73	C0830A	77	C0961A	70
C0587A	65	C0724A	73	C0831A	77	C0971A	71
C0588A	65	C0725A	73	C0832A	77	C0972A	71
C0589A	65	C0726A	73	C0833A	77	C0973A	71
C0590A	65	C0728A	73	C0835A	77	C0974A	71
C0600A	73	C0729A	73	C0836A	77	C0975A	71
C0601A	73	C0730A	73	C0839A	77	C0976A	71
C0602A	73	C0740A	68	C0841A	76	C0977A	71
C0603A	73	C0741A	68	C0842A	76	C0978A	71
C0604A	73	C0742A	68	C0843A	76	C0979A	71
C0605A	73	C0743A	68	C0844A	76	C0980A	71
C0606A	73	C0744A	68	C0890A	74	C0981A	71
C0607A	73	C0745A	68	C0893A	74	C1000A	154
C0608A	73	C0746A	68	C0894A	74	C1001A	154
C0609A	73	C0747A	68	C0896A	74	C1002A	154
C0610A	73	C0748A	68	C0897A	74	C1003A	154
C0611A	73	C0749A	68	C0899A	74	C1004A	154
C0612A	73	C0750A	68	C0901A	74	C1005A	154
C0620A	75	C0751A	68	C0910A	83	C1102	101
C0621A	75	C0753A	68	C0911A	83	C1103	101
C0622A	75	C0754A	68	C0912A	83	C1104	101
C0623A	75	C0755A	68	C0913A	83	C1106	101
C0624A	75	C0760A	69	C0914A	83	C1108A	94
C0625A	75	C0761A	69	C0915A	83	C1110	102
C0626A	75	C0762A	69	C0916A	83	C1112	102
C0628A	75	C0763A	69	C0917A	83	C1117	100

Part Number Index

CATALOG NUMBER	PAGE	CATALOG NUMBER	PAGE	CATALOG NUMBER	PAGE	CATALOG NUMBER	PAGE
C1118	139	C1335A	33	C1673A	46	C2428A	14
C1119	139	C1337A	33	C1676A	46	C2429A	14
C1123	139	C1338A	161	C1700	152	C2430A	14
C1124	139	C1340A	160	C1701	152	C2431A	14
C1126	139	C1341A	33	C1702	152	C2433A	13
C1130	139	C1343A	160	C1703	152	C2434A	14
C1135	101	C1345A	159	C1704	152	C2435A	14
C1142	101	C1350A	60	C1705	152	C2436A	14
C1154	94	C1352A	58	C1800	153	C2437A	14
C1155	100	C1353A	58	C1801	153	C2440A	14
C1156	110	C1356	156	C1802	153	C2443A	14
C1158	105	C1357	156	C1803	153	C2461A	11
C1160	96	C1358	156	C1804	153	C2462A	11
C1162	109	C1360	156	C1805	153	C2463A	11
C1164	109	C1361	156	C2003A	2	C2464A	11
C1166	100	C1362	156	C2004A	2	C2465A	11
C1176A	111	C1363	156	C2015A	2	C2466A	11
C1178	100	C1364	157	C2016A	2	C2467A	11
C1180	94	C1368A	80	C2028A	2	C2470A	11
C1188	100	C1458.15.90	151	C2040A	2	C2471A	11
C1198	94	C1458.55.90	151	C2052A	2	C2473A	11
C1201	175	C1458.56.90	151	C2053A	2	C2488A	11
C1202	41, 175	C1458.57.90	151	C2064A	2	C2509A	164
C1203	41	C1461.15.90	151	C2065A	2	C2510A	164
C1204	41	C1461.55.90	151	C2100A	3	C2511A	164
C1206	41	C1461.56.90	151	C2101A	3	C2513A	23
C1208	41	C1461.57.90	151	C2102A	3	C2514A	23
C1210	41	C1463.15.90	151	C2103A	3	C2515A	23
C1212	41	C1463.55.90	151	C2104A	3	C2516A	23
C1226A	173	C1463.56.90	151	C2105A	3	C2517A	23
C1228A	171	C1558.15.92	155	C2106A	3	C2518A	24
C1300	172	C1561.15.92	155	C2107A	3	C2519A	24
C1301	172	C1563.15.92	155	C2117A	3	C2520A	24
C1302	40, 172	C1602	41, 175	C2118A	3	C2521A	24
C1304	40	C1603	41	C2119A	3	C2523A	23
C1305	40	C1604	41	C2404A	13	C2524A	23
C1308	40	C1606	41	C2405A	14	C2525A	23
C1310	40	C1608	41	C2406A	14	C2526A	23
C1312	40	C1612	41	C2409A	14	C2528A	23
C1313	40	C1614	41	C2410A	14	C2534A	23
C1318	7	C1642A	35	C2412A	13	C2535A	23
C1319	7	C1643A	35	C2420A	13	C2536A	23
C1320A	7	C1644A	35	C2421A	13	C2537A	23
C1321	7	C1645A	35	C2422A	13	C2538A	23
C1322A	174	C1646A	35	C2423A	13	C2539A	23
C1326	7	C1648A	38	C2424A	13	C2540A	23
C1331A	160	C1670A	46	C2425A	14	C2543A	25
C1332A	36	C1671A	46	C2426A	14	C2555A	23
C1333A	159	C1672A	46	C2427A	14	C2676A	34

Part Number Index

CATALOG NUMBER	PAGE	CATALOG NUMBER	PAGE	CATALOG NUMBER	PAGE	CATALOG NUMBER	PAGE
C2677A	34	C3126	16	C3208	48	C3527	104
C2678A	36	C3127	17	C3210	122	C3528	97
C2679A	36	C3128	17	C3211	122	C3529	98
C2680A	36	C3129	17	C3214	55	C3602	21
C2681A	36	C3134	16	C3215	55	C3603	21
C2683A	36	C3135	16	C3216	55	C3604	21
C2686A	36	C3150	48	C3217	55	C3605	21
C2687A	36	C3151	48	C3218	55	C3606	21
C2688A	36	C3152	48	C3220	122	C3607	21
C2689A	36	C3153	48	C3223	122	C3608	21
C2754A	9	C3154	27	C3224	122	C3610	21
C2768A	33	C3155	27	C3225	122	C4008A	9, 43
C2830A	13	C3156	61	C3240	127	C4010A	43
C2831A	13	C3157	61	C3241	127	C4014A	43
C2882A	33	C3158	28	C3242	127	C4015A	43
C2888A	33	C3159	28	C3243	127	C4017A	43
C2892A	33	C3162	27	C3244	127	C4062A	12
C2895A	33	C3163	27	C3245	127	C4063A	12
C3028	56	C3164	27	C3246	127	C4064A	12
C3029	56	C3165	48	C3247	127	C4065A	12
C3030	56	C3166	27	C3260	124	C4066A	12
C3031	56	C3167	128	C3261	124	C4067A	12
C3060	28	C3168	128	C3270	124	C4070A	12
C3061	28	C3169	27	C3271	124	C4071A	12
C3062	28	C3170	128	C3280	124	C4073A	12
C3063	28	C3171	128	C3282	124	C4075A	12
C3064	28	C3172	128	C3283	124	C4076A	12
C3065	28	C3173	128	C3284	124	C4077A	12
C3068	28	C3174	128	C3310	27	C4078A	12
C3102	16	C3175	128	C3311	27	C4079A	12
C3103	16	C3178	16	C3320	27	C4080	139
C3105	16	C3179	16	C3321	27	C4081A	10
C3106	16	C3180	27	C3322	27	C4082A	10
C3110	17	C3181	27	C3340	27	C4083A	10
C3111	17	C3182	27	C3341	27	C4084A	10
C3112	17	C3183	28	C3352	52	C4088A	12
C3113	17	C3184	28	C3353	52	C4090	139
C3114	17	C3190	16	C3354	52	C4100A	18
C3115	17	C3191	16	C3355	52	C4101A	18
C3116	17	C3192	16	C3362	52	C4102A	18
C3117	17	C3193	16	C3364	52	C4103A	18
C3118	17	C3194	16	C3500	104	C4104A	18
C3119	17	C3195	16	C3519	100	C4105A	18
C3120	17	C3200	122	C3520	109	C4106A	18
C3121	17	C3201	122	C3521	91	C4107A	18
C3122	17	C3204	48	C3523	91	C4108A	18
C3123	17	C3205	48	C3524	91	C4109A	18
C3124	17	C3206	48	C3525	91	C4110A	18
C3125	17	C3207	48	C3526	104	C4111A	18

Part Number Index

CATALOG NUMBER	PAGE	CATALOG NUMBER	PAGE	CATALOG NUMBER	PAGE	CATALOG NUMBER	PAGE
C4112A	18	C4161A	29	C4210A	30	C4331A	129
C4113A	18	C4162A	29	C4211A	30	C4332A	129
C4114A	18	C4163A	29	C4212A	30	C4333A	129
C4115A	18	C4164A	29	C4213A	30	C4334A	120
C4116A	18	C4165A	29	C4214A	19	C4335A	120
C4117A	19	C4166A	30	C4215A	30	C4336A	120
C4118A	19	C4167A	29	C4216A	31	C4337A	120
C4119A	19	C4168A	29	C4217A	31	C4338A	120
C4120A	19	C4169A	29	C4218A	31	C4339A	120
C4121A	19	C4170A	53	C4219A	31	C4340A	120
C4122A	19	C4171A	53	C4220A	31	C4341A	120
C4123A	19	C4172A	53	C4221A	31	C4342A	120
C4124A	19	C4173A	53	C4222A	31	C4343A	120
C4125A	19	C4174A	53	C4223A	31	C4344A	120
C4126A	19	C4175A	53	C4224A	31	C4345A	120
C4127A	19	C4176A	53	C4225A	31	C4346A	120
C4128A	19	C4177A	53	C4226A	31	C4347A	120
C4129A	19	C4178A	53	C4227A	31	C4348A	120
C4130A	19	C4179A	53	C4228A	31	C4349A	118
C4131A	19	C4180A	53	C4229A	31	C4350A	120
C4132A	19	C4181A	53	C4230A	31	C4408	138
C4133A	19	C4182A	53	C4300A	118	C4408ST	138
C4134A	19	C4183A	54	C4301A	118	C4410	138
C4135A	20	C4184A	54	C4302A	118	C4412	138
C4136A	20	C4185A	54	C4304A	118	C4412ST	138
C4137A	20	C4186A	54	C4305A	118	C4413	138
C4138A	20	C4187A	54	C4306A	118	C4841A	76
C4139A	20	C4188A	54	C4307A	118	C4842A	76
C4140A	20	C4189A	54	C4308A	118	C4843A	76
C4141A	20	C4190A	54	C4309A	118	C4844A	76
C4142A	20	C4191A	53	C4310A	118	C5011	96
C4143A	20	C4192A	30	C4311A	9	C5025	96
C4144A	20	C4193A	30	C4312A	118	C5029	96
C4145A	20	C4194A	30	C4313A	118	C5034	96
C4146A	20	C4195A	30	C4314A	118	C5039	97
C4147A	20	C4196A	30	C4315A	118	C5043	98
C4148A	20	C4197A	30	C4316A	118	C5044	97
C4149A	20	C4198A	30	C4317A	118	C5076	139
C4150A	20	C4199A	30	C4318A	118	C5078	139
C4151A	20	C4200A	30	C4321A	118	C5084	139
C4152A	29	C4201A	30	C4322A	118	C5086	139
C4153A	29	C4202A	30	C4323A	118	C5096	139
C4154A	29	C4203A	59	C4324A	118	C5460	139
C4155A	29	C4204A	30	C4325A	118	C5760	88
C4156A	29	C4205A	30	C4326A	118	C5761	88
C4157A	29	C4206A	19	C4327A	118	C5770	103
C4158A	29	C4207A	30	C4328A	129	C5775	88
C4159A	29	C4208A	30	C4329A	129	C5776	88
C4160A	29	C4209A	53	C4330A	129	C5777	89

Part Number Index

CATALOG NUMBER	PAGE	CATALOG NUMBER	PAGE	CATALOG NUMBER	PAGE	CATALOG NUMBER	PAGE
C5778	91	C6118A	44	C8030	101	CP6.30.06	144
C5780	103	C6119A	44	C8031	91	CP6.30.07	144
C5784	103	C6120A	44	C8101	49	CP6.30.10	144
C5785	89	C6121A	44	C8102	15	CP6.A3.02	144
C5802	89	C6310	138	C8103	49	CP6.A3.03	144
C5804	89	C6311	138	C8104	49	CP6.A3.05	144
C5814	90	C6312	138	C8105	62	CP6.A3.06	144
C5822	90	C6313	138	C8106	26	CP6.A3.07	144
C5830	103	C6348A	12	C8107	39	CP6.A3.10	144
C5886	88	C6351A	13	C8108	39	CR5.30.02	145
C5889	89	C6352A	13	C8109	49	CR5.30.03	145
C6010A	43	C6353A	13	C8110	39	CR5.30.05	145
C6014A	43	C6355A	13	C8111	39	CR5.30.06	145
C6015A	43	C6356A	13	C8112	63	CR5.30.07	145
C6017A	43	C6357A	13	C8113	51	CR5.30.10	145
C6019A	43	C6358A	13	C8114	26	CR5.A3.02	145
C6023A	43	C6360A	13	C8115	39	CR5.A3.03	145
C6026A	43	C6367	157	C8116	45	CR5.A3.05	145
C6035A	81	C6451A	47	C8117	57	CR5.A3.06	145
C6036A	81	C6500A	37	C8118	50	CR5.A3.07	145
C6040A	82	C6501A	37	C8119	39	CR5.A3.10	145
C6041A	82	C6502A	37	C8120	39	CR6.30.02	144
C6042A	82	C6503A	37	C8122	45	CR6.30.03	144
C6043A	82	C6504A	37	C8123	51	CR6.30.05	144
C6044A	82	C6505A	37	C8124	51	CR6.30.06	144
C6045A	82	C6506A	37	C8125	185	CR6.30.07	144
C6046A	82	C6507A	37	C8126	51	CR6.30.10	144
C6047A	82	C6508A	37	C8127	51	CR6.A3.02	144
C6048A	82	C7102A	156	C8128	64	CR6.A3.03	144
C6049A	82	C7104A	46	C8129	57	CR6.A3.05	144
C6050A	82	C7106A	58	C8131	62	CR6.A3.06	144
C6051A	82	C7108A	7	C8132	63	CR6.A3.07	144
C6052A	82	C7112A	66	C8133	62	CR6.A3.10	144
C6053A	82	C7114A	66	C8134	62	E1000S	134
C6054A	82	C7116A	66	CP5.30.02	145	E1001S	134
C6056A	82	C7600A	4	CP5.30.03	145	E1002S	134
C6058A	82	C7602A	4	CP5.30.05	145	E1003S	134
C6059A	82	C7604A	4	CP5.30.06	145	E1004S	134
C6060A	82	C7606A	4	CP5.30.07	145	E1006S	134
C6061A	165	C7608A	4	CP5.30.10	145	E1008S	134
C6062A	165	C7610A	4	CP5.A3.02	145	E1010S	134
C6065A	82	C7611A	4	CP5.A3.03	145	E1012S	134
C6066A	82	C8000	112	CP5.A3.05	145	E1022S	134
C6067A	82	C8001	112	CP5.A3.06	145	E1023S	134
C6101A	44	C8014	112	CP5.A3.07	145	E1024S	134
C6103A	44	C8025	102	CP5.A3.10	145	E1030S	134
C6106A	44	C8027	104	CP6.30.02	144	E1032S	134
C6109A	44	C8028	104	CP6.30.03	144	E1033S	134
C6111A	44	C8029	91	CP6.30.05	144	E1034S	134

Part Number Index

CATALOG NUMBER	PAGE	CATALOG NUMBER	PAGE	CATALOG NUMBER	PAGE	CATALOG NUMBER	PAGE
E1036S	134	E2032S	135	E2484S	119	E3503S	121
E1038S	134	E2033S	135	E2502S	119	E3504S	121
E1040S	134	E2034S	135	E2503S	119	E3506S	121
E1041S	134	E2036S	135	E2504S	119	E3512S	121
E1042S	134	E2038S	135	E2506S	119	E3514S	121
E1043S	134	E2040S	135	E2508S	119	E3522S	121
E1044S	134	E2041S	135	E2522S	119	E3524S	121
E1052S	134	E2042S	135	E2524S	119	E3532S	121
E1054S	134	E2043S	135	E2532S	119	E3534S	121
E1062S	134	E2044S	135	E2534S	119	E3542S	123
E1064S	134	E2052S	135	E2542S	119	E3602S	123
E1482S	117	E2054S	135	E2544S	119	E3603S	123
E1484S	117	E2062S	135	E3000S	136	E3604S	123
E1486S	117	E2064S	135	E3001S	136	E3606S	123
E1502S	117	E2100S	137	E3002S	136	E3612S	123
E1503S	117	E2102S	137	E3003S	136	E3614S	123
E1504S	117	E2103S	137	E3004S	136	E3622S	123
E1505S	117	E2104S	137	E3006S	136	E3624S	123
E1506S	117	E2106S	137	E3008S	136	E3632S	123
E1508S	117	E2108S	137	E3010S	136	E3634S	123
E1512S	117	E2122S	137	E3012S	136	E3842S	162
E1514S	117	E2123S	137	E3022S	136	E3843S	162
E1522S	117	E2124S	137	E3023S	136	E024C0045510	184
E1524S	117	E2200S	137	E3024S	136	E026C0045510	184
E1532S	117	E2202S	137	E3030S	136	E028C0045510	184
E1534S	117	E2203S	137	E3032S	136	E028P0181510	184
E1842S	162	E2204S	137	E3033S	136	E028P0501510	184
E1843S	162	E2206S	137	E3034S	136	E030C0045510	184
E2000S	135	E2208S	137	E3036S	136	SP00C0011010	182
E2002S	135	E2242S	137	E3038S	136	SP00C0012010	182
E2003S	135	E2243S	137	E3042S	136	Z028C0061110	183
E2004S	135	E2244S	137	E3043S	136	Z028C0066110	184
E2006S	135	E2252S	137	E3044S	136	Z028C0042010	184
E2008S	135	E2254S	137	E3052S	136	Z028C0042210	184
E2010S	135	E2262S	137	E3054S	136	Z028C0042410	184
E2012S	135	E2264S	137	E3062S	136	Z028C0042610	184
E2022S	135	E2402S	117	E3064S	136	Z028C0042810	184
E2023S	135	E2404S	117	E3482S	121	Z028C0101120	184
E2024S	135	E2406S	117	E3484S	121		
E2030S	135	E2482S	119	E3502S	121		

In stock. At your service.

In these challenging times, Carol® Brand is here to serve you. General Cable has a **full range of in-stock Electronics products** and a knowledgeable, friendly staff ready to assist you. With Carol Brand, you can *Demand Better ... Expect More.™*

- Competitive prices that save your customers money while enhancing your margins
- 4 Regional Distribution Centers across the US to ship from stock when you need wire
- A free sample program for end-user conversions
- Carol University training
- Carol stocking programs with limited risk
- EDI & VMI programs for enhanced service, increased turns and improved profitability
- The self-service ability to check product availability and your order status with www.mygeneralcable.com

**CAROL
BRAND**

REEL People ... Adding REAL Value

 **General Cable**

4 Tesseneer Drive
Highland Heights, Kentucky 41076-9753
Phone: 1.888.295.5896
Fax: 1.800.547.8249
www.generalcable.com

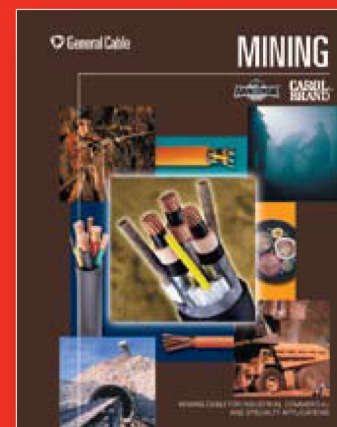
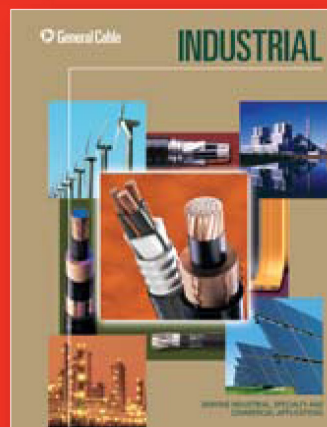
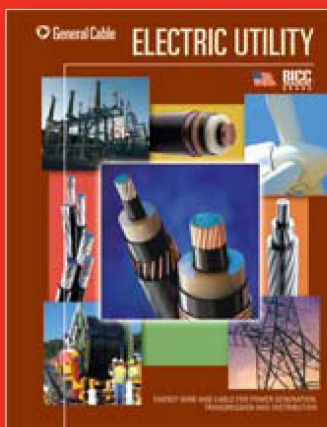
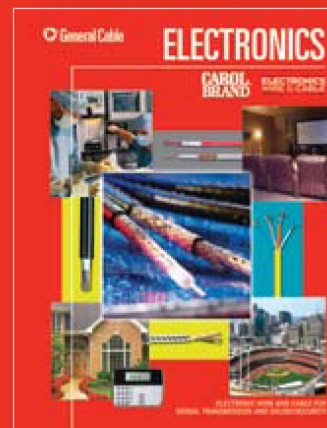
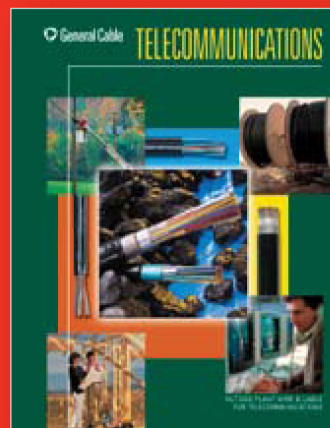
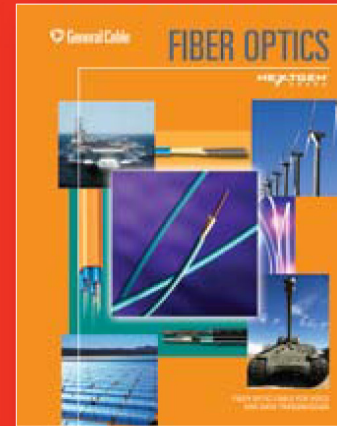
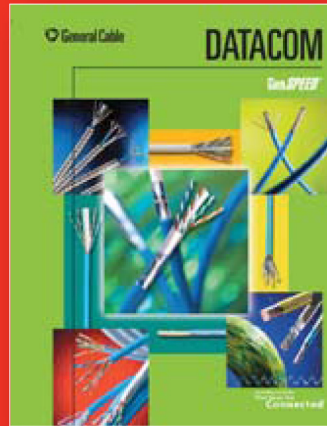
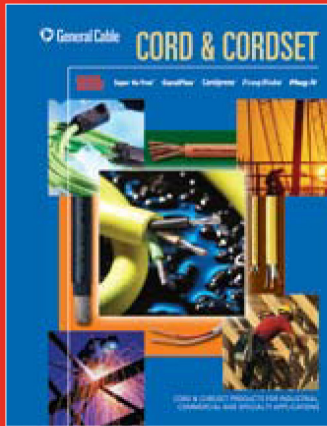

General Cable
4 Tesseneer Drive
Highland Heights,
Kentucky 41076-9753
U.S.A.
www.generalcable.com

Telephone (888) 295-5896
Fax (800) 547-8249
International Telephone +1 859 572 8000
International Fax +1 859 572 8058