

Model I-7022

Model I-7022 2-channel Analog Output Module

I-7000 is a family of network data acquisition and control modules providing analog to digital, digital to analog, digital input/output, timer/counter and other functions. The modules can be remotely controlled by a set of commands.

The I-7022 is a 2-channel analog output module that uses the D/A converter to convert digital data into analog output signals with 12-bit resolution and current read-back function.

Specifications

Analog Input

- Photo-isolation: 3750 Vrms
- Channels: 2
- Output type: mA, V
- Voltage output: 0 to 10V
- Current output: 0 to 20mA , 4 to 20mA
- Effective resolution: 12-bit for I-7021
- Accuracy: $\pm 0.1\%$ of FSR
- Read back accuracy: $\pm 1\%$ of FSR
- Resolution: $\pm 0.02\%$ of FSR
- Zero drift:
 - Voltage output: $\pm 30\mu\text{V}/^\circ\text{C}$
 - Current output: $\pm 0.2\mu\text{A}/^\circ\text{C}$
- Span temperature coefficient: $\pm 25\text{ppm}/^\circ\text{C}$
- Programmable output slope:
 - 0.125 to 1024 mA/second
 - 0.0625 to 512 V/second
- Current load resistance:
 - Internal power: 500 Ohms
 - External 24V: 1050 Ohms
- Isolation: 3000V DC
- Channel to channel isolation

Features/Benefits

- 3000VDC isolated analog input
- Programmable Power On value of analog output
- Programmable slew rate
- Software calibration
- Dual watchdog

PIN Assignments

	1	Ext.PWR1	20
		-VOUT1	
		+VOUT1	
		-IOUT1	
		+IOUT1	
		Ext.PWR0	
		-VOUT0	
		+VOUT0	
		-IOUT0	
		+IOUT0	11
INIT*			
(Y)DATA+			
(G)DATA-			
(R)+Vs			
(B)GND	10		

Block Diagram

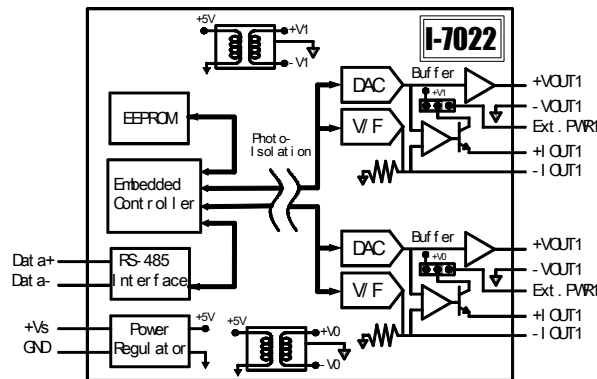

International Headquarters:

B & B Electronics Mfg. Co. 707 Dayton Road P.O. Box 1040 Ottawa, IL 61350 USA
815-433-5100 Fax 433-5104 www.bb-elec.com orders@bb-elec.com support@bb-elec.com

B & B Electronics Ltd Westlink Commercial Park Oranmore Co. Galway Ireland
+353 91 792444 Fax +353 91 792445 www.bb-europe.com orders@bb-elec.com support@bb-europe.com

RS-485 Connector

Asynchronous 2-wire half-duplex
Pluggable terminal block: Pitch 5.08mm

Baud Rate

1.2K/2.4K/4.8K/9.6K/19.2K/38.4K/57.6K/115.2K bps

Wire Connection

Voltage output

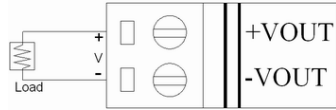

Current output

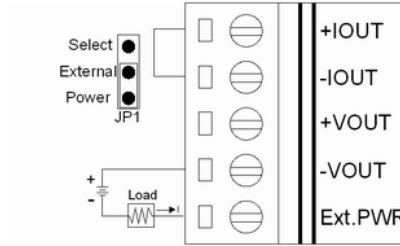
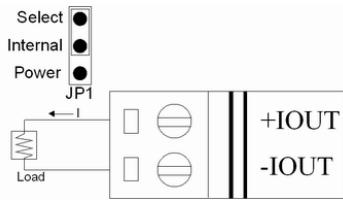

Power Requirements

Power input: +10 to +30VDC input

Power Consumption

3Watt

Environmental

Storage temperature: -25 to 80°C (-13 to 176 °F)
Operation temperature: -20 to 75°C (-4 to 167 °F)
Humidity: 5 to 95%, non-condensing

Dimensions LxWxH: 120 x 72 x 33 cm
(47.2 x 28.4 x 13.0 in)

Certification: CE

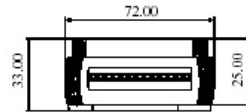

Top View

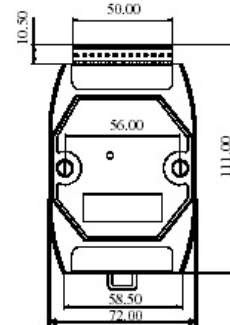

From View

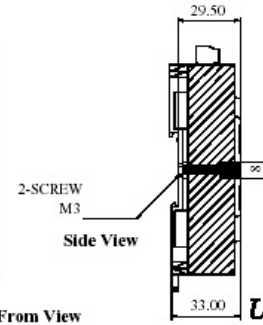

Side View

Unit : mm

International Headquarters:

B & B Electronics Mfg. Co. 707 Dayton Road P.O. Box 1040 Ottawa, IL 61350 USA
815-433-5100 Fax 433-5104 www.bb-elec.com orders@bb-elec.com support@bb-elec.com

B & B Electronics Ltd Westlink Commercial Park Oranmore Co. Galway Ireland
+353 91 792444 Fax +353 91 792445 www.bb-europe.com orders@bb-elec.com support@bb-europe.com