

SP-200 SOLDER TIP CARTRIDGES

500 Series X=5, 600 Series X=6, 700 Series X=7

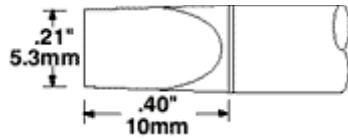

SSC-X17A
Extra Large Chisel
.21" (5.3mm)

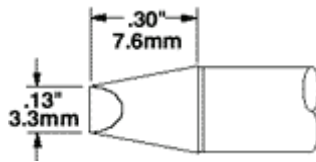

SSC-X13A
Chisel 90°
.13" (3.3mm)

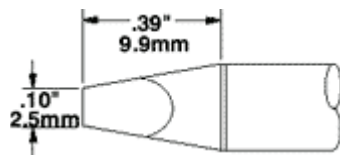

SSC-X36A
Chisel 30°
.10" (2.5mm)

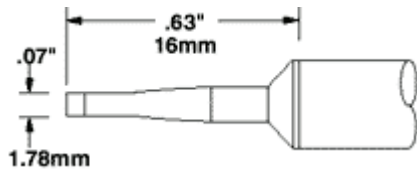

SSC-X42A
Long Reach Chisel 60°
.07" (1.78mm)

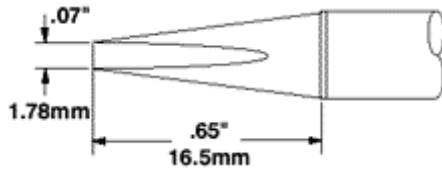

SSC-X70A
Long Chisel
.07" (1.78mm)

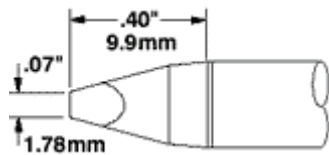

SSC-X37A
Chisel 30°
.07" (1.78mm)

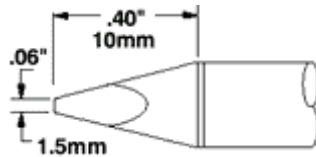

SSC-X38A
Chisel 30°
.06" (1.5mm)

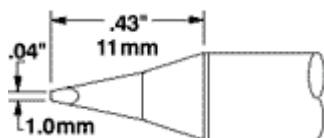

SSC-X25A
Chisel 30°
.04" (1.0mm)

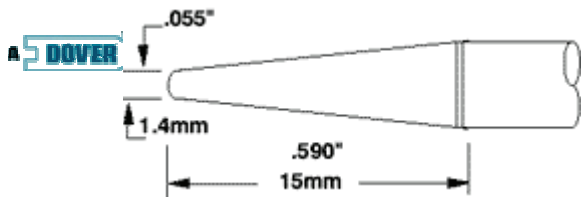

SSC-X74A
Conical Sharp
.055" (1.4mm)

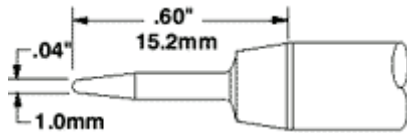

SSC-X01A
Conical Sharp
.04" (1.0mm)

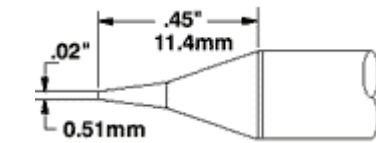

SSC-X22A
Conical Sharp
.02" (0.51mm)

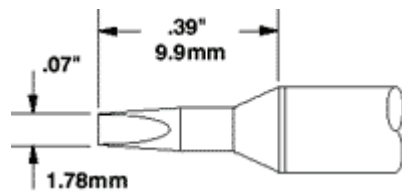

SSC-X72A
Conical Chisel
.07" (1.78mm)

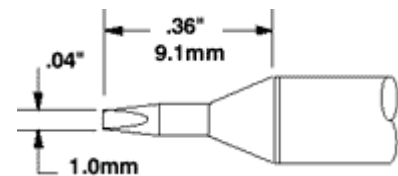

SSC-X71A
Conical Chisel
.04" (1.0mm)

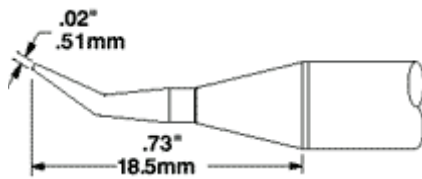

SSC-X54A
Sharp Bent 30°
.02" (0.51mm)

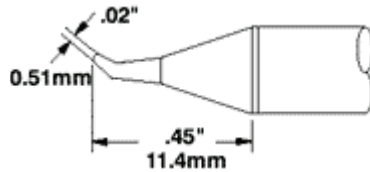

SSC-X26A
Sharp Bent 30°
.02" (0.51mm)

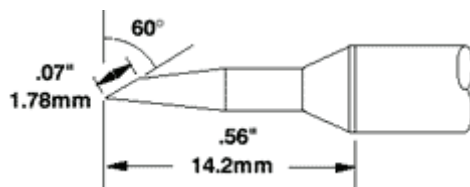

SSC-X47A
Bevel 60°
.07" (1.78mm)

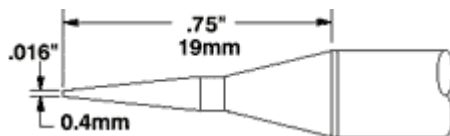

SSC-X45A
Bevel 60°
.016" (0.4mm)

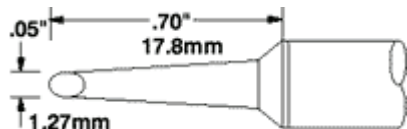

SSC-X67A
Drag Soldering Tip
(Mini-Hoof)

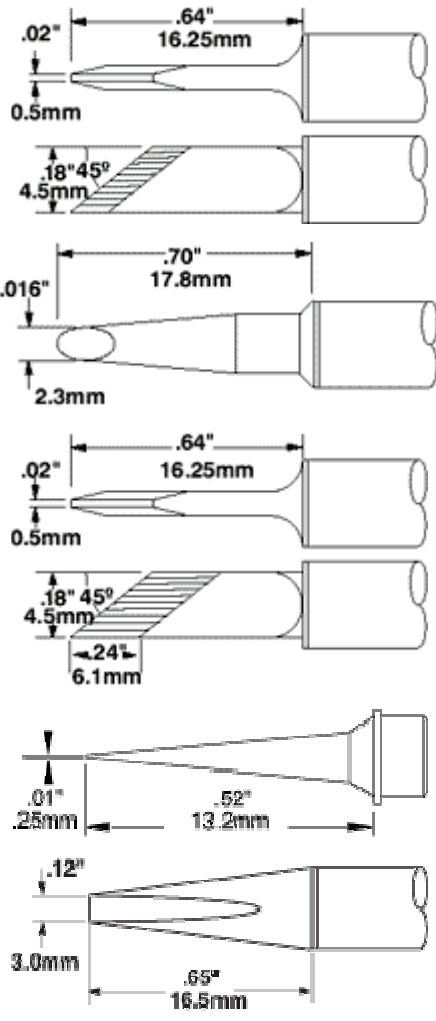

SSC-X61A

Drag Soldering Tip
(Knife)

SSC-X39A

Drag Soldering Tip
(Hoof)

SSC-X73A

Drag Soldering Tip
(Increased Tinned Area, .24" 6.1mm)

SSC-X90A

Micro Fine
.01 (0.25 mm)

SSC-X46A

Long Reach Chisel
.12" (3 mm)

Soldering Accesories

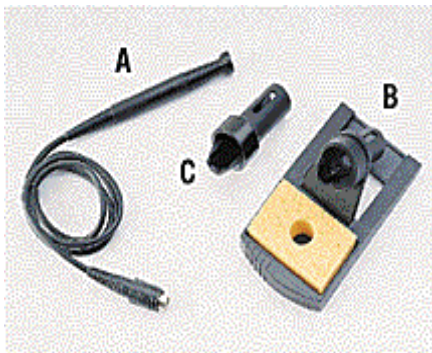

Ref. Model	Description
A SP-HC1	Solder handle/cord for SP200
B WS2	Solder workstand with YS3 Sponge
C WS2CB	Replacement cradle for WS2
* AC-YS3	Sponge for WS2(not shown)

Miscellaneous Accesories

AC-CP2 Cartridge Removal Pad