

LT4H-W

Panasonic
ideas for life

**DIN 48 SIZE
DIGITAL TIMER**

LT4H-W

Digital
Timers

UL File No.: E122222
C-UL File No.: E122222

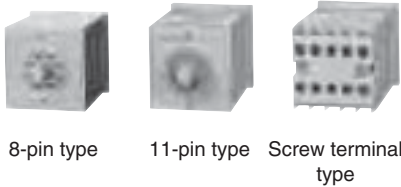
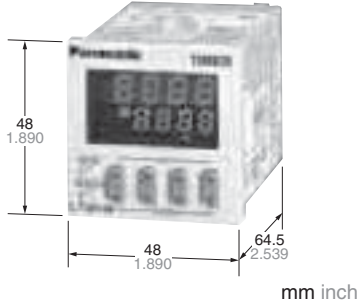

Features

- Wide time range**
 The operation time range covers from 0.01 sec. to 9999 hours.
 The individual setting can be performed on each of 1 and 2 timers.
 99.99s 99min59s 99h59min
 999.9s 999.9min 999.9h
 9999s 9999h
- Bright and Easy-to-Read Display**
 A brand new bright 2-color back light LCD display. The easy-to-read screen in any location makes checking and setting procedures a cinch.
- Simple Operation**
 Seesaw buttons make operating the unit even easier than before.
- Short Body of only 64.5 mm 2.539 inch (screw terminal type) or 70.1 mm 2.760 inch (pin type)**
 With a short body, it is easy to install in even narrow control panels.

- Conforms to IP66's Weather Resistant Standards**
 The water-proof panel keeps out water and dirt for reliable operation even in poor environments.
- Screw terminal (M3.5) and Pin Types are Both Standard Options**
 The two terminal types are standard options to support either front panel installation or embedded installation.
- Changeable Panel Cover**
 Also offers a black panel cover to meet your design considerations.
- Compliant with UL, c-UL and CE.**

Product types

Time range	Operating mode	Output	Operating voltage	Power down insurance	Terminal type	Part number	
99.99s 999.9s 9999s 99min59s 999.9min 99h59min 999.9h 9999h	Pulse input: • Delayed one shot • OFF-start flicker • ON-start flicker Integrating input: • Delayed one shot • OFF-start flicker • ON-start flicker	Relay (1 c)	100 to 240 V AC	Available	8 pins	LT4HW8-AC240V	
						11 pins	LT4HW-AC240V
						Screw terminal	LT4HW-AC240VS
					24 V AC	8 pins	LT4HW8-AC24V
					11 pins	LT4HW-AC24V	
					Screw terminal	LT4HW-AC24VS	
			12 to 24 V DC		8 pins	LT4HW8-DC24V	
			11 pins		LT4HW-DC24V		
			Screw terminal		LT4HW-DC24VS		
			Transistor (1 a)		100 to 240 V AC	8 pins	LT4HWT8-AC240V
						11 pins	LT4HWT-AC240V
						Screw terminal	LT4HWT-AC240VS
			24 V AC	8 pins	LT4HWT8-AC24V		
			11 pins	LT4HWT-AC24V			
			Screw terminal	LT4HWT-AC24VS			
			12 to 24 V DC	8 pins	LT4HWT8-DC24V		
			11 pins	LT4HWT-DC24V			
				Screw terminal	LT4HWT-DC24VS		

* A rubber gasket (ATC18002) and a mounting frame (AT8-DA4) are included.

Part names

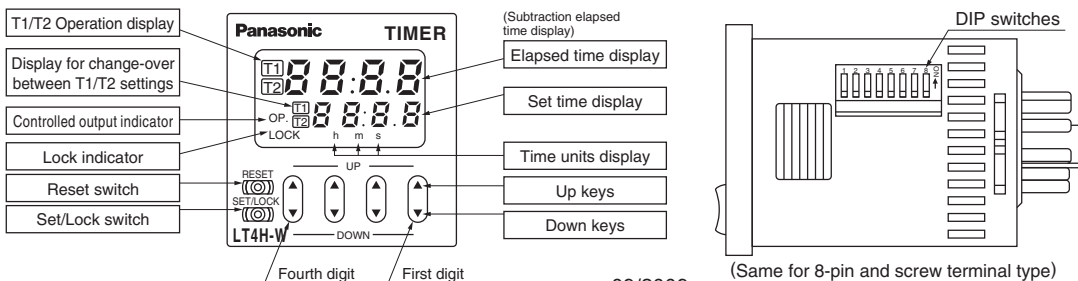

09/2009

(Same for 8-pin and screw terminal type)

Specifications

Item	Type	Relay output type		Transistor output type	
		AC type	DC type	AC type	DC type
Rating	Rated operating voltage	100 to 240 V AC, 24 V AC	12 to 24 V DC	100 to 240V AC, 24V AC	12 to 24 V DC
	Rated frequency	50/60 Hz common	—	50/60 Hz common	—
	Rated power consumption	Max. 10 V A	Max. 3 W	Max. 10 V A	Max. 3 W
	Rated control capacity	5 A, 250 V AC		100 mA, 30 V DC	
	Time range	99.99s, 999.9s, 9999s, 99min59s, 999.9min, 99h59min, 999.9h, 9999h (selected by DIP switch)			
	Time counting direction	Addition (UP)/Subtraction (DOWN) (2 directions selectable by DIP switch)			
	Operation mode	Pulse input: Delayed one shot, OFF-start flicker or ON-start flicker Integrating input: Delayed one shot, OFF-start flicker or ON-start flicker			
	Start/Reset/Stop input	Min. input signal width: 1 ms, 20 ms (2 directions by selected by DIP switch) (The 8 pin type does not have a stop input.)			
	Lock input	Min. input signal width: 20 ms (The 8-pin type does not have a lock input.)			
	Input signal	Open collector input Input impedance: Max. 1 kΩ; Residual voltage: Max. 2V Open impedance: 100 kΩ or less, Max. energized voltage: 40 V DC			
	Indication	7-segment LCD, Elapsed value (backlight red LED), Setting value (backlight yellow LED)			
Power failure memory method	EEP-ROM (Min. 10· overwriting)				
Time accuracy (max.)	Operating time fluctuation	± (0.005% + 50 ms) in case of power on start ± (0.005% + 20 ms) in case of input signal start		[Operating voltage: 85% to 110% Temperature: -10°C to +55°C +14°F to +131°F Min. input signal width: 1ms]	
	Temperature error				
	Voltage error				
	Setting error				
Contact	Contact arrangement	Timed-out 1 Form C		Timed-out 1 Form A (Open collector)	
	Contact resistance (Initial value)	100 mΩ (at 1 A 6 V DC)		—	
	Contact material	Ag alloy/Au flash		—	
Life	Mechanical (contact)	Min. 2x10 ⁶ ope. (Except for switch operation parts)		—	
	Electrical (contact)	Min. 10 ⁶ ope. (At rated control voltage)		Min. 10 ⁶ ope. (At rated control voltage)	
Electrical	Allowable operating voltage range	85 to 110 % of rated operating voltage			
	Breakdown voltage (Initial value)	2,000 Vrms for 1 min: Between live and dead metal parts (11-pin type only) 2,000 Vrms for 1 min: Between input and output 1,000 Vrms for 1 min: Between contacts		2,000 Vrms for 1 min: Between live and dead metal parts (Pin type only) 2,000 Vrms for 1 min: Between input and output	
	Insulation resistance (Initial value)	Min. 100 MΩ:	Between live and dead metal parts Between input and output (At 500V DC) Between contacts	Min. 100 MΩ:	Between live and dead metal parts Between input and output (At 500V DC)
	Operating voltage reset time	Max. 0.5 s			
	Temperature rise	Max 65° C (under the flow of nominal operating current at nominal voltage)		—	
Mechanical	Vibration resistance	Functional	10 to 55 Hz: 1 cycle/ min single amplitude of 0.35 mm .014 inch (10 min on 3 axes)		
		Destructive	10 to 55 Hz: 1 cycle/ min single amplitude of 0.75 mm .030 inch (1 h on 3 axes)		
	Shock resistance	Functional	Min. 98 m 321.522 ft./s (4 times on 3 axes)		
		Destructive	Min. 294 m 964.567 ft./s (5 times on 3 axes)		
Operating conditions	Ambient temperature	-10° C to 55° C +14° F to +131° F			
	Ambient humidity	Max. 85 % RH (non-condensing)			
	Air pressure	860 to 1,060 h Pa			
	Ripple rate	—	20 % or less	—	20 % or less
Connection	8-pin/11-pin/screw terminal				
Protective construction	IP66 (front panel with rubber gasket)				

Applicable standard

Safety standard	EN61812-1	Pollution Degree 2/Overvoltage Category II
EMC	(EMI)EN61000-6-4 Radiation interference electric field strength	EN55011 Group1 ClassA EN55011 Group1 ClassA
	Noise terminal voltage (EMS)EN61000-6-2 Static discharge immunity	EN61000-4-2 4 kV contact 8 kV air
	RF electromagnetic field immunity	EN61000-4-3 10 V/m AM modulation (80 MHz to 1 GHz) 10 V/m pulse modulation (895 MHz to 905 MHz)
	EFT/B immunity	EN61000-4-4 2 kV (power supply line) 1 kV (signal line)
	Surge immunity	EN61000-4-5 1 kV (power line)
	Conductivity noise immunity	EN61000-4-6 10 V/m AM modulation (0.15 MHz to 80 MHz)
	Power frequency magnetic field immunity	EN61000-4-8 30 A/m (50 Hz)
	Voltage dip/Instantaneous stop/Voltage fluctuation immunity	EN61000-4-11 10 ms, 30% (rated voltage) 100 ms, 60% (rated voltage) 1,000 ms, 60% (rated voltage) 5,000 ms, 95% (rated voltage)

LT4H-W

Dimensions

(units: mm inch)

Tolerance: ±1.0 ±.039

• LT4H-W digital timer

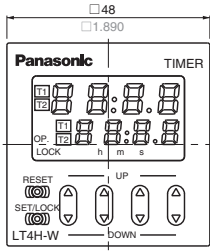

Screw terminal type
(Flush mount)

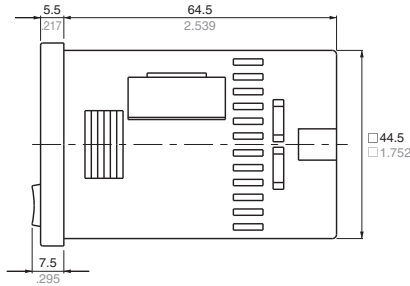

Pin type
(Flush mount/Surface mount)

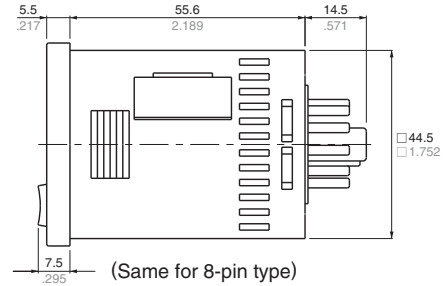

(Same for 8-pin type)

• Dimensions for flush mount (with adapter installed)

Screw terminal type

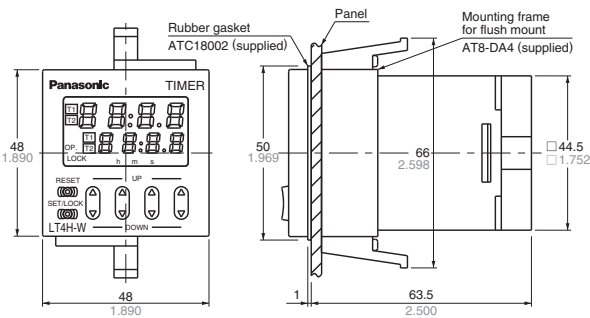

Pin type

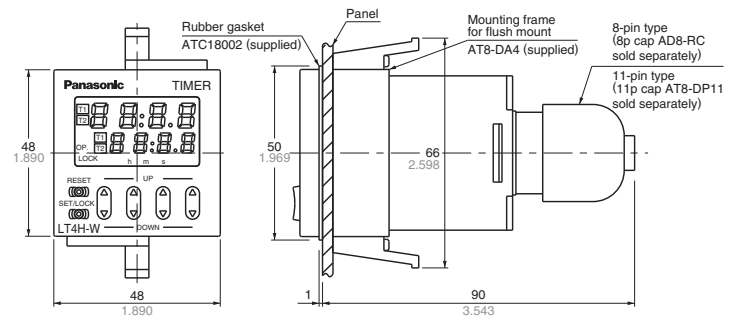

• Dimensions for front panel installations

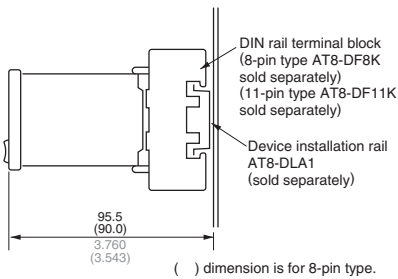

• Installation panel cut-out dimensions

The standard panel cut-out dimensions are shown below. Use the mounting frame (AT8-DA4) and rubber gasket (ATC18002).

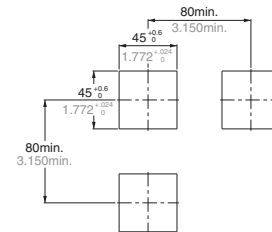

• For connected installations

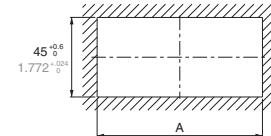

When n timers are continuously installed, the dimension (A) is calculated according to the following formula (n: the number of the timers to be installed):

$$A = (48 \times n - 2.5)^{+0.8} \quad A = (1.890 \times n - .098)^{+0.024}$$

Note) 1: The installation panel thickness should be between 1 and 5 mm .039 and .197 inch.

2: For connected installations, the waterproofing ability between the unit and installation panel is lost.

Terminal layouts and wiring diagrams

• 8-Pin type

Relay output type

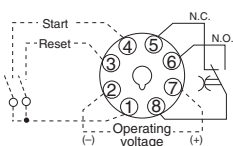

Transistor output type

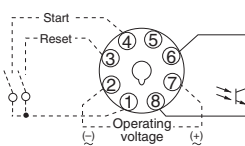

• 11-Pin type

Relay output type

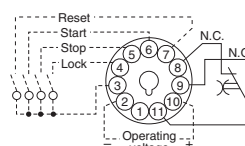

Transistor output type

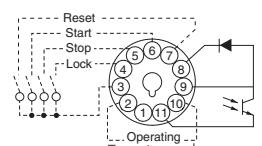

• Screw terminal type

Relay output type

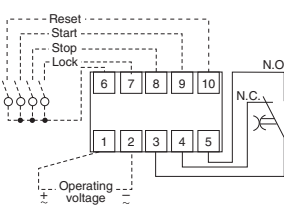

Transistor output type

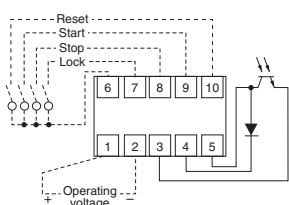

Note) For connecting the output leads of the transistor output type, refer to 5) Transistor output on page 26.

Setting the operation mode and time range

Setting procedure 1) Setting the time range (Timer T₁/Timer T₂)

Set the time range with the DIP switches on the side of the LT4H-W timer.

Item	DIP switch		
	OFF	ON	
1	Refer to table 1		
2			
3			
*4	Minimum input reset, start, and stop signal width	20 ms	1 ms
5	Time delay direction	Addition	Subtraction
6	Refer to table 2		
7			
8			

* The 8-pin type does not have the stop input, so that the dip switch can be changed over between reset and start inputs. The signal range of the lock input is fixed (minimum 20 ms).

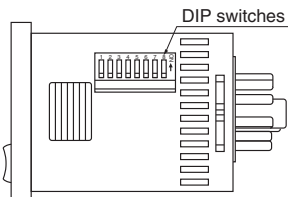

(same for screw terminal type and 8-pin type.)

Table 1: Setting the time range (Timer T₁)

DIP switch No.			Time range
1	2	3	
ON	ON	ON	0.01 s to 99.99 s
OFF	OFF	OFF	0.1 s to 999.9 s
ON	OFF	OFF	1 s to 9999 s
OFF	ON	OFF	0 min 01 s to 99 min 59 s
ON	ON	OFF	0.1 min to 999.9 min
OFF	OFF	ON	0 h 01 min to 99 h 59 min
ON	OFF	ON	0.1 h to 999.9 h
OFF	ON	ON	1 h to 9999 h

Table 2: Setting the time range (Timer T₂)

DIP switch No.			Time range
6	7	8	
ON	ON	ON	0.01 s to 99.99 s
OFF	OFF	OFF	0.1 s to 999.9 s
ON	OFF	OFF	1 s to 9999 s
OFF	ON	OFF	0 min 01 s to 99 min 59 s
ON	ON	OFF	0.1 min to 999.9 min
OFF	OFF	ON	0 h 01 min to 99 h 59 min
ON	OFF	ON	0.1 h to 999.9 h
OFF	ON	ON	1 h to 9999 h

Notes: 1) Set the DIP switches before installing the timer.
 2) When the DIP SW setting is changed, turn off the power once.
 3) The DIP switches are set as ON before shipping.

Setting procedure 2) Setting the operation mode

Set the operation mode with the keys on the front of the LT4H-W timer.

- ① Elapsed time display
- ② Set time display
- ③ T₁/T₂ operation indicator
- ④ T₁/T₂ setting value selectable indicator
- ⑤ Controlled output indicator
- ⑥ Lock indicator
- ⑦ Time units display

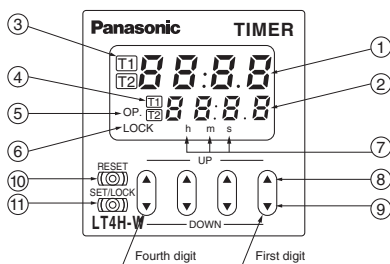

- ⑧ UP keys
Changes the corresponding digit of the set time in the addition direction (upwards)
- ⑨ DOWN keys
Changes the corresponding digit of the set time in the subtraction direction (downwards)
- ⑩ RESET switch
Resets the elapsed time and the output
- ⑪ SET/LOCK switch
Changes over the display between T₁/T₂ settings, sets the operation mode, checks the operation mode and locks the operation of each key (such as up, down or reset key).

1) Setting or changing the operation mode

- (1) When the UP or DOWN key at the first digit is pressed with the SET/LOCK switch pressed, the mode is changed over to the setting mode.
- (2) Now release the SET/LOCK switch.
- (3) The operation mode in the setting mode is changed over sequentially in the left or right direction by pressing the UP or DOWN key at the first digit, respectively.

Ex: Setting operation mode display (PULSE-A example)

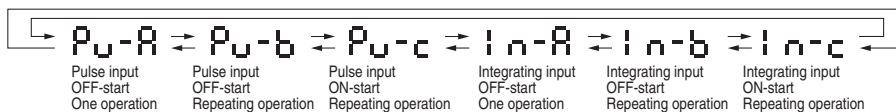
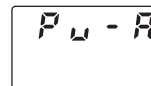

(4) The operational mode displayed at present is set by pressing the RESET switch, and the display returns to the normal condition.

2) Setting (changing) the time

- (1) Pressing the SET/LOCK key switches the set value display between T₁ and T₂. Display the timer (T₁ or T₂) which is to be set (or changed).
- (2) After displaying the timer (T₁ or T₂) which is to be set, press the UP or DOWN key to change the time.

• Checking the operation mode

When the UP or DOWN key at the second digit is pressed with the SET/LOCK switch pressed, the operational mode can be checked. The display returns to the normal condition after indicating the operational mode for about two seconds. (While the display indicates the operational mode for about two seconds, the other indicators continue to operate normally.)

• Setting the lock

When the UP or DOWN key at the fourth digit is pressed with the SET/LOCK switch pressed, all keys on the unit are locked. The timer does not accept any of UP, DOWN and RESET keys.

To release the lock setting, press the UP or DOWN key at the fourth digit again with the set/lock switch pressed.

* Operational mode, adding and subtracting and minimum input signal range cannot be set at T₁ and T₂, respectively.

• Changing over the T₁/T₂ setting display

The T₁/T₂ setting display is changed over by pressing the SET/LOCK switch. (This operation gives no effect on the other operations. The set time and elapsed time (residual time) at T₁ are linked with those at T₂.)

• Changing the set time

- 1) It is possible to change the set time with the UP and DOWN keys even during time delay with the timer. However, be aware of the following points.
 - (1) If the set time is changed to less than the elapsed time with the time delay set to the addition direction, time delay will continue until the elapsed time reaches full scale, returns to zero, and then reaches the new set time. If the set time is changed to a time above the elapsed time, the time delay will continue until the elapsed time reaches the new set time.
 - (2) If the time delay is set to the subtraction direction, time delay will continue until "0" regardless of the new set time.
- 2) When the set times at T₁ and T₂ are set to 0, the output becomes ON only while the start input is carried out. However, while the reset input is carried out, the output becomes OFF.

Operation Mode

	PULSE : Pulse input	INTEGRATION : Integrating input
PULSE Delayed one shot A	<p style="text-align: center;">PULSE A OFF-start/1 operation $t_1 < T_1, t_2 < T_2$</p> <ul style="list-style-type: none"> • Elapsed value cleared when power is turned on. • Time limit start initiated when start input goes on; start input ignored if time limit interval is in progress. • Elapsed value cleared when one operation has been completed. 	<p style="text-align: center;">INTEGRATION A OFF-start/1 operation $t_1 < T_1, t_2 < T_2$</p> <ul style="list-style-type: none"> • Elapsed value not cleared when power is turned on (power failure backup function). • When power is turned back on, same status is maintained for output as that previous to power going off. • Elapsed value cleared when one operation has been completed.
OFF-start flicker B	<p style="text-align: center;">PULSE B OFF-start/repeating operation $t_1 < T_1, t_2 < T_2$</p> <ul style="list-style-type: none"> • Elapsed value cleared when power is turned on. • Time limit start initiated when start input goes on; start input ignored if time limit interval is in progress. 	<p style="text-align: center;">INTEGRATION B OFF-start/repeating operation $t_1 < T_1, t_2 < T_2$</p> <ul style="list-style-type: none"> • Elapsed value not cleared when power is turned on (power failure backup function). • When power is turned back on, same status is maintained for output as that previous to power going off.
ON-start flicker C	<p style="text-align: center;">ON-start/repeating operation $t_1 < T_1, t_2 < T_2$</p> <ul style="list-style-type: none"> • Elapsed value cleared when power is turned on. • Time limit start initiated when start input goes on; start input ignored if time limit interval is in progress. 	<p style="text-align: center;">ON-start/repeating operation $t_1 < T_1, t_2 < T_2$</p> <ul style="list-style-type: none"> • Elapsed value not cleared when power is turned on (power failure backup function). • When power is turned back on, same status is maintained for output as that previous to power going off.
Remarks and notes	<ul style="list-style-type: none"> • The pulse input mode starts the operation by starting the start input. • When using the unit by starting it with the power on, short-circuit the start terminal (8-pin: ① to ④, 11-pin: ③ to ⑥ and screw terminal: ⑥ to ⑨). 	<ul style="list-style-type: none"> • The integrating input mode is operated by the integrated time of the start input. In other word, the timer operates only when the start input is performed. • When the elapsed value is cleared by the reset input, the output is reset. • When using the unit by starting it with the power on, short-circuit the start terminal (8-pin: ① to ④, 11-pin: ③ to ⑥ and screw terminal: ⑥ to ⑨).
	<ul style="list-style-type: none"> • Each signal input such as start, reset, stop and lock inputs is applied by short-circuiting its input terminal and common terminal (8-pin type: terminal ①, 11-pin type: terminal ③ and screw terminal: terminal ⑥) respectively. • The 8-pin type does not have a stop input or lock input. 	

LT4H SERIES CAUTIONS FOR USE

1. Terminal wiring

1) When wiring the terminals, refer to the terminal layout and wiring diagrams and be sure to perform the wiring properly without errors.

2) When using the instrument with an flush mounting, the screw-down terminal type is recommended. For the pin type, use either the rear terminal block (AT78041) or the 8P cap (AD8-RC) for the 8-pin type, and the rear terminal block (AT78051) or the 11P cap (AT8-DP11) for the 11-pin type. Avoid soldering directly to the round pins on the unit. When using the instrument with a front panel installation, use the DIN rail terminal block (AT8-DF8K) for the 8-pin type and the DIN rail terminal block (AT8-DF11K) for the 11-pin type.

3) After turning the unit off, make sure that any resulting induced voltage or residual voltage is not applied to power supply terminals ② through ⑦ (8-pin type) ② through ⑩ (11-pin type) or ① and ② (screw terminal type). (If the power supply wire is wired parallel to the high voltage wire or power wire, an induced voltage may be generated between the power supply terminals.)
4) Have the power supply voltage pass through a switch or relay so that it is applied at one time. If the power supply is applied gradually, the counting may malfunction regardless of the settings, the power supply reset may not function, or other such unpredictable occurrence may result.

2. Input connections

The power circuit has no transformer (power and input terminals are not insulated). When an input signal is fed to two or more timers at once, do not arrange the power circuit in an independent way. If the timer is powered on and off independently as shown in Fig. A, the timer's internal circuitry may get damaged. Be careful never to allow such circuitry. (Figs. A, B and C show the circuitry for the 11-pin type.)

(Fig. A)
Input contact point or transistor

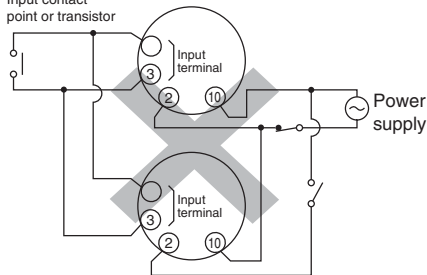

If independent power circuitry must be used, keep the input contacts or transistors separate from each other, as shown in Fig. B.

(Fig. B)

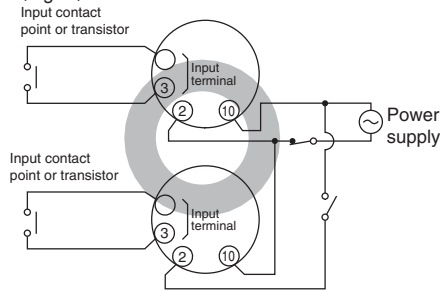

When power circuitry is not independent, one input signal can be fed to two or more counters at once, as shown in Fig. C.

(Fig. C)

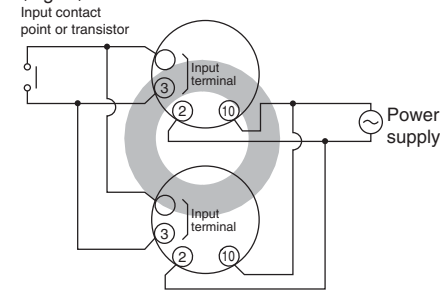

3. Input and output

1) Signal input type

(1) Contact point input

Use highly reliable metal plated contacts. Since the contact point's bounce time leads directly to error in the timer operations, use contacts with as short a bounce time as possible. Also, select a minimum input signal width of 20 ms.

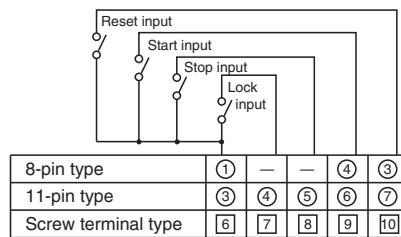

(2) Non-contact point input

Connect with an open collector. Use transistors whose characteristics satisfy the criteria given below.

$V_{CE0} = 20 \text{ V min.}$

$I_C = 20 \text{ mA min.}$

$I_{CBO} = 6\mu\text{A max.}$

Also, use transistors with a residual voltage of less than 2 V when the transistor is on.

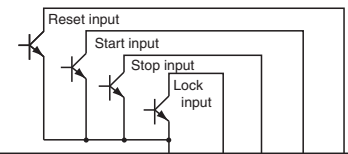

8-pin type	①	—	—	④	③
11-pin type	③	④	⑤	⑥	⑦
Screw terminal type	⑥	⑦	⑧	⑨	⑩

* The short-circuit impedance should be less than $1 \text{ k}\Omega$.

[When the impedance is 0Ω , the current coming from the start input and stop input terminals is approximately 12 mA, and from the reset input and lock input terminals is approximately 1.5 mA.]

Also, the open-circuit impedance should be more than $100 \text{ k}\Omega$.

* As shown in the diagram below, from a non-contact point circuit (proximity switches, photoelectric switches, etc.) with a power supply voltage of between 12 and 40 V, the signal can be input without using an open collector transistor. In the case of the diagram below, when the non-contact point transistor Q switches from off to on (when the signal voltage goes from high to low), the signal is input.

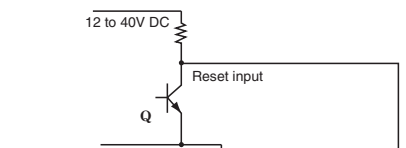

8-pin type	①	—	—	④	③
11-pin type	③	④	⑤	⑥	⑦
Screw terminal type	⑥	⑦	⑧	⑨	⑩

(The above example is for reset input)

2) The input mode and output mode change depending on the DIP switch settings. Therefore, before making any connections, be sure to confirm the operation mode and operation conditions currently set.

3) The LT4H series use power supply without a transformer (power and input terminals are not insulated). In connecting various kinds of input signals, therefore, use a power transformer in which the primary side is separated from the ungrounded secondary side as shown in Fig. A, for the power supply for a sensor and other input devices so that short-circuiting can be prevented.

LT4H SERIES CAUTIONS FOR USE

Once the wiring to be used is completely installed and prior to installing this timer, confirm that there is complete insulation between the wires connected to the power terminals (2 each) and the wires connected to each input terminal. If the power and input lines are not insulated, a short-circuit may occur inside the timer and result in internal damage. In addition, when moving your equipment to a new installation location, confirm that there is no difference in environmental conditions as compared to the previous location.

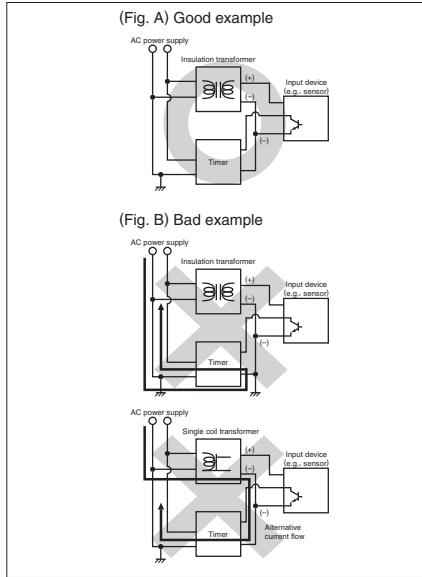

4) The input signal is applied by the shorting of each input terminal with the common terminal (terminal ① for 8-pin types, terminal ③ for 11-pin types and terminal ⑥ for screw terminal types). **N e v e r** connect other terminals or voltages higher than 40V DC, because it may destroy the internal circuitry.

5) Transistor output

(1) Since the transistor output is insulated from the internal circuitry by a photocoupler, it can be used as an NPN

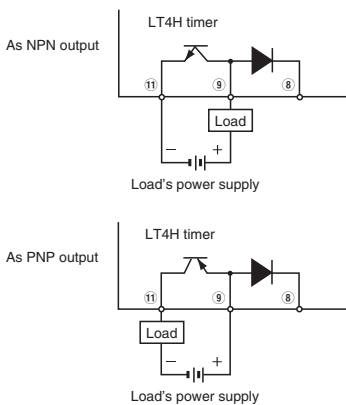

Note: With the 8-pin type, there is no diode between points ⑧ and ⑨.

output or PNP (equal value) output. (The above example is 11-pin type)

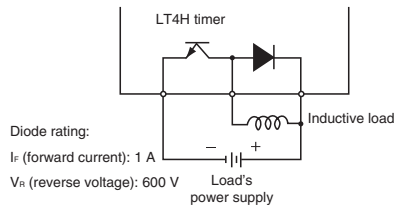

- (2) Use the diode connected to the output transistor's collector for absorbing the reverse voltage from induced loads.
- 6) When wiring, use shielded wires or metallic wire tubes, and keep the wire lengths as short as possible.
- 7) For the load of the controlled output, make sure that it is lower than the rated control capacity.

4. Operation of LT4H digital timer

1) Turning on and off the power supply while operating in A2* (Power on delay 2) or G (Totalizing On delay) will result in a timer error to be generated due to the characteristics of the internal circuitry. Therefore, use the start input or stop input.

* Not related to the start input.

2) When controlling the timer by turning on the power supply, use only A (Power on delay 1) or A2 (Power on delay 2). Use of other modes in this situation will result in timer errors. When using the other modes, control the timer with the start input or stop input.

5. Operation mode and time range setting

The operation mode and time range can be set with the DIP switches on the side of the timer. Make the DIP switch settings before installing the timer on the panel.

The operation mode of LT4H-W series can be set with the keys and switches on the front of the timer.

6. Conditions of usage

- 1) Avoid locations subject to flammable or corrosive gases, excessive dust, oil, vibrations, or excessive shocks.
- 2) Since the cover of the timer is made of polycarbonate resin, avoid contact with or use in environments containing methyl alcohol, benzene, thinners, and other organic solvents; and ammonia, caustic sodas, and other alkaline substances.
- 3) If power supply surges exceed the values given below, the internal circuits may

Operating voltage	Surge voltage (peak value)
AC type	6,000V
DC type 24V AC type	1,000V

• Surge wave form
[± (1.2x50) μs uni-polar full wave voltage]

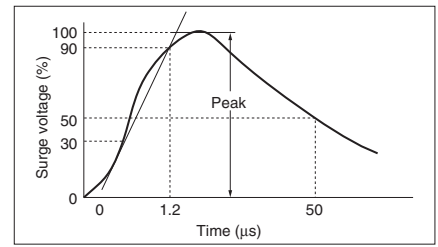

become damaged. Be sure to use surge absorbing element to prevent this from happening.

4) Regarding external noise, the values below are considered the noise-resistant voltages. If voltages rise above these

	Power supply terminals		Input terminals
	AC type	DC type 24V AC type	
Noise voltage	1,500V	1,000V	600V

values, malfunctions or damage to the internal circuitry may result, so take the necessary precautions.

Noise wave form (noise simulator)

Rise time: 1 ns

Pulse width: 1 μs, 50 ns

Polarity: ±

Cycle: 100 cycles/second

5) When connecting the operating power supply, make sure that no leakage current enters the timer. For example, when performing contact protection, if set up like that of fig. A, leaking current will

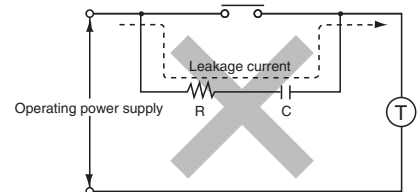

(Fig. A)

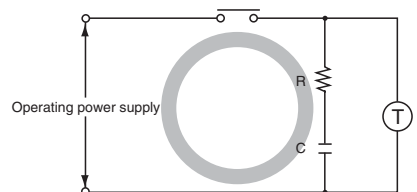

(Fig. B)

pass through C and R, enter the unit, and cause incorrect operation. The fig. B shows the correct setup.

6) Long periods of continuous operation in the time-up completed condition (one month or more) will result in the weakening of the internal electrical components from the generated heat and, therefore, should be avoided. If you do plan to use

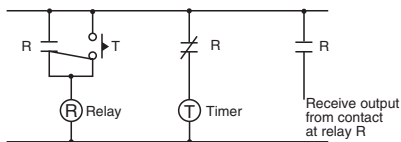

the unit for such continuous operation, use in conjunction with a relay as shown in the circuit in the diagram below.

7. Acquisition of CE marking

Please abide by the conditions below when using in applications that comply with EN61812-1.

- 1) Overvoltage category III, pollution level 2
- 2) This timer employs a power supply without a transformer, so the power and input signal terminals are not insulated.
 - (1) When a sensor is connected to the input circuit, install double insulation on the sensor side.
 - (2) In the case of contact input, use dual-insulated relays, etc.
 - 3) The load connected to the output contact should have basic insulation.

This timer is protected with basic insulation and can be double-insulated to meet EN/IEC requirements by using basic insulation on the load.

- 4) Please use a power supply that is protected by an overcurrent protection device which complies with the EN/IEC standard (example: 250 V 1 A fuse, etc.).
- 5) You must use a terminal socket or socket for the installation. Do not touch the terminals or other parts of the timer when it is powered. When installing or un-installing, make sure that no voltage is being applied to any of the terminals.
- 6) Do not use this timer as a safety circuit. For example when using a timer in a heater circuit, etc., provide a protection circuit on the machine side.

7. Self-diagnosis function

If a malfunction occurs, one of the following displays will appear.

Display	Contents	Output condition	Restoration procedure	Preset values after restoration
	Malfunctioning CPU.	OFF	Enter reset input, RESET key, or restart unit.	The values at start-up before the CPU malfunction occurred.
	Malfunctioning memory. See note.			0

Note: Includes the possibility that the EEPROM's life has expired.