

MODEL CSMSTRV2 – MODULAR CONTROLLER SERIES MASTER



- PERFORMS HIERARCHICAL CONTROL OF OTHER MODULES IN THE MODULAR CONTROLLER SERIES
- PROVIDES POWER AND COMMUNICATIONS TO MODULES THROUGH BACKPLANE CONNECTOR
- STORES MODULE CONFIGURATION INFORMATION, AND AUTOMATICALLY REPROGRAMS REPLACED MODULES
- EXTENSIVE BUILT-IN DRIVER LIST ALLOWS EASY DATA MAPPING TO PLCs, PCs, AND SCADA SYSTEMS
- INDEPENDENT SERIAL PORTS PROVIDE VIRTUALLY UNLIMITED INTEGRATION METHODS
- 10 BASE-T/100 BASE-TX ETHERNET CONNECTION PROVIDES NETWORKING CAPABILITY
- SUPPORTS UP TO 16 MODULAR CONTROLLER SERIES MODULES
- SUPPORTED BY CRIMSON® 2.0 SOFTWARE (OLDER CRIMSON 1.0 FILES MAY BE IMPORTED INTO CRIMSON 2.0)

GENERAL DESCRIPTION

The Model CSMSTRV2 is a communications and control platform designed for use with Modular Controller Series slave modules. The CSMSTRV2 uses a proprietary high speed serial protocol to communicate, via backplane connection, with up to 16 slave modules. Through the same connection, the Master also provides power to the modules.

When powered up, the CSMSTRV2 automatically identifies and addresses connected slave modules. By storing the configuration information of all of the modules, the CSMSTRV2 is able to automatically configure modules if they are replaced.

The Master provides high-speed RS232/422/485 communication ports and an Ethernet port for connection to PCs, PLCs, and SCADA systems. An extensive list of master and slave protocol drivers are available to allow the CSMSTRV2 to share and exchange variable data with external devices. The 10 Base-T/100 Base-TX Ethernet port can also be used to connect and share data with other devices at high speeds.

The CSMSTRV2 was designed as a direct replacement for the original CSMSTRSE. This new model provides benefits such as support via Crimson® 2.0 software, which allows configuration files to be uploaded. To save programming time, files originally created in Crimson 1.0 (.cdb files) may be imported into Crimson 2.0.

The design of the Modular Controller Series high density packaging and DIN rail mounting saves time and panel space. The controller snaps easily onto standard top hat (T) profile DIN rail.

SOFTWARE

The CSMSTRV2 is programmed with Crimson® 2.0 software for Windows® 2000 or later platforms. The software is an easy to use, graphical interface which provides a means of communication configuration, as well as commissioning and calibration of new systems.

CONTENTS OF PACKAGE

- CS Master
- Termination Plug
- Terminal Block for connecting power.

SAFETY SUMMARY

All safety related regulations, local codes and instructions that appear in the manual or on equipment must be observed to ensure personal safety and to prevent damage to either the instrument or equipment connected to it. If equipment is used in a manner not specified by the manufacturer, the protection provided by the equipment may be impaired.

Do not use the controller to directly command motors, valves, or other actuators not equipped with safeguards. To do so can be potentially harmful to persons or equipment in the event of a fault to the controller. An independent and redundant temperature limit indicator with alarm outputs is strongly recommended.

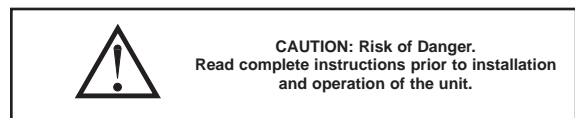
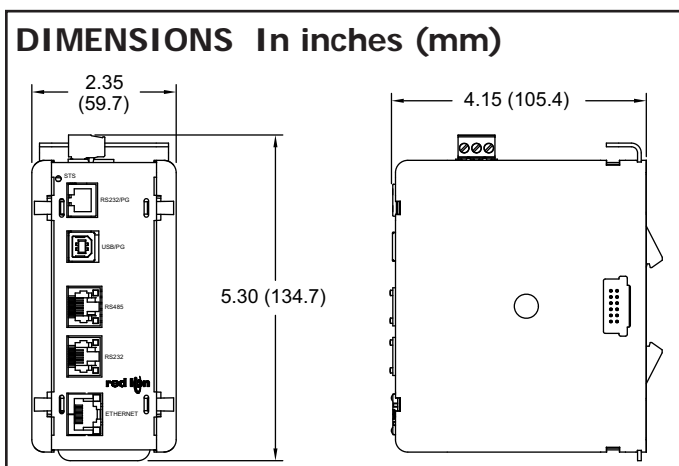

SPECIFICATIONS

1. **POWER:** 24 VDC \pm 10%
400 mA min. (1 module)
3 Amps max. (16 modules)
Must use NEC Class 2 or Limited Power Source (LPS) rated power supply.
2. **COMMUNICATIONS:**
USB/PG Port: Adheres to USB specification 1.1. Device only using Type B connection.
Serial Ports: Format and Baud Rates for each port are individually software programmable up to 115,200 baud.
RS232/PG Port: RS232 port via RJ12
COMMS Ports: RS422/485 port via RJ45, and RS232 port via RJ12
DH485 TXEN: Transmit enable; open collector, $V_{OH} = 15$ VDC, $V_{OL} = 0.5$ V @ 25 mA max.
Note: For additional information on the communications or signal common and connections to earth ground please see the "Connecting to Earth Ground" in the section "Installing and Powering the CSMSTRSX."
Ethernet Port: 10 BASE-T / 100 BASE-TX
RJ45 jack is wired as a NIC (Network Interface Card).
3. **LEDs:**
STS – Status LED indicates condition of master.
TX/RX – Transmit/Receive LEDs show serial activity.
Ethernet – Link and activity LEDs.
4. **MEMORY:**
On-board User Memory: 4 Mbytes of non-volatile Flash memory.
On-board SDRAM: 2 Mbytes
5. **ENVIRONMENTAL CONDITIONS:**
Operating Temperature Range: 0 to 50 °C
Storage Temperature Range: -30 to +70 °C
Operating and Storage Humidity: 80% max relative humidity, non-condensing, from 0 to 50 °C
Vibration According to IEC 68-2-6: 5 to 150 Hz, in X, Y, Z direction for 1.5 hours, 2 g's.
Shock According to IEC 68-2-27: Operational 25 g's, 11 msec in 3 directions.
Altitude: Up to 2000 meters
6. **CONSTRUCTION:** Case body is burgundy high impact plastic and stainless steel. For indoor use only. Installation Category II, Pollution Degree 2.

7. **POWER CONNECTION:** Removable wire clamp screw terminal block.
Wire Gage Capacity: 24 AWG to 12 AWG
Torque: 4.45 to 5.34 in/lb (0.5 to 0.6 N-m)
 8. **MOUNTING:** Snaps onto standard DIN style top hat (T) profile mounting rails according to EN50022 -35 x 7.5 and -35 x 15.
 9. **CERTIFICATIONS AND COMPLIANCES:**
SAFETY
UL Listed, File #E302106, UL508, CSA 22.2 No. 14-M05
LISTED by Und. Lab. Inc. to U.S. and Canadian safety standards
IEC 61010-1, EN 61010-1: Safety requirements for electrical equipment for measurement, control, and laboratory use, Part 1.
ELECTROMAGNETIC COMPATIBILITY
Emissions and Immunity to EN 61326: 2006: Electrical Equipment for Measurement, Control and Laboratory use.
Immunity to Industrial Locations:

Electrostatic discharge	EN 61000-4-2	Criterion B 4 kV contact discharge 8 kV air discharge
Electromagnetic RF fields	EN 61000-4-3	Criterion B ³ 10 V/m
Fast transients (burst)	EN 61000-4-4	Criterion B power 2 kV I/O signal 1 kV
Surge	EN 61000-4-5	Criterion B power 1kV L-L, 2 kV L-G signal 1kV
RF conducted interference	EN 61000-4-6	Criterion A 3 V/rms

Emissions:
Emissions EN 55011 Class A
 10. **WEIGHT:** 12.9oz (365.7g)
- Notes:*
1. *Criterion A: Normal operation within specified limits.*
 2. *Criterion B: Temporary loss of performance from which the unit self-recovers.*
 3. *The module's with analog input and/or output signals may have their signals deviate during disturbance but self-recover when the disturbance is removed.*

ORDERING INFORMATION

TYPE	MODEL NO.	DESCRIPTION	PART NUMBER
Master Module	CSMSTR ¹	Modular Controller Master, Comms, Ethernet	CSMSTRV2
		Modular Controller Master with multiple protocol converter, data logger, web server with Virtual HMI up to QVGA (320 x 240) size and expansion slot.	CSMSTRSX
		Modular Controller Master with multiple protocol converter, data logger, web server with Virtual HMI up to VGA (640 x 480) size and expansion slot with increased SDRAM.	CSMSTRGT
Communications Cables (10 feet)	CBL	RS232 Programming Cable	CBLPROG0
		USB Cable	CBLUSB00
		Communications Cables ¹	CBLxxxxx
Software	SFCRM2	Crimson 2.0 ² , Modular Controller Manual, and Download Cable	SFCRM2MC
Power Supply	PSDR	DIN Rail Mounted Power Supply	PSDRxxxx
Accessories	G3CF	CompactFlash Card ³	G3CFxxxx
		Rail Stops (Qty 2)	RSRSTP00
		Replacement Base	CSBASE00
		Replacement Termination Plug	CSTERM00

¹ Visit www.redlion.net for a complete list of PID modules, data acquisition modules, communications drivers and cables.

The CSMSTRV2 was designed as a direct replacement for the original CSMSTRSE. This new model provides benefits such as support via Crimson[®] 2.0 software that allows configuration files to be uploaded. To save programming time, files originally created in Crimson 1.0 (.cdb files) may be imported into Crimson 2.0.

² Use this part number to purchase Crimson on CD with a printed Modular Controller Manual, USB cable, and RS-232 cable. Otherwise, download free of charge from www.redlion.net.

³ Industrial grade two million write cycles. SMART Modular Technologies model SG9CF (UL Listed Directory Category NWGQ).

HARDWARE

INSTALLATION

DIN rail should be mounted horizontally so that the unit's ventilation holes are vertical in relation to cabinet orientation. A minimum clearance of 1 inch (25.4 mm) should be maintained above and below the unit in order to ensure proper thermal regulation.

The unit shall be installed inside a UL Listed Industrial Control Panel or similar type of enclosure. A minimum 3.2 mm distance shall be maintained between the hazardous live parts of the equipment and accessible parts of the fire/electrical enclosure.

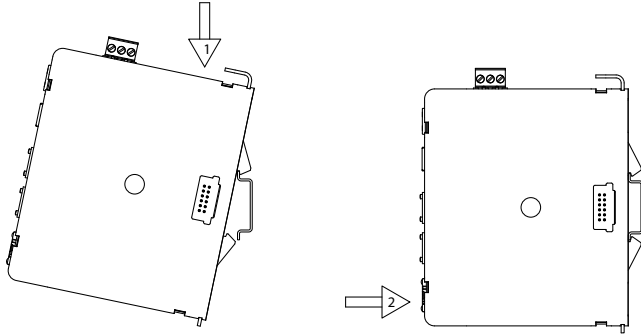

Figure 1 - Attach CSMSTR Master To DIN Rail

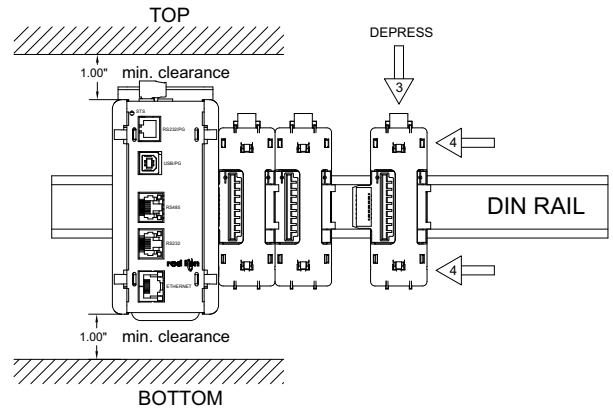

Figure 2 - Attach Slave Bases To DIN Rail

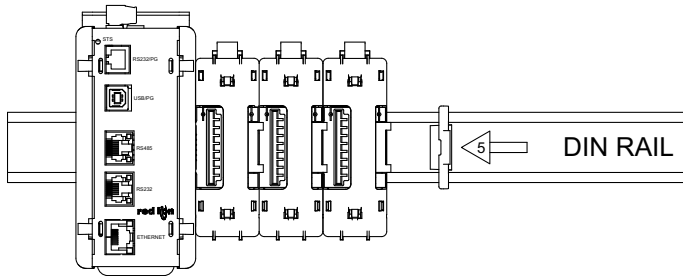

Figure 3 - Attach Termination Plug*
* Supplied with CSMSTR Master Module.

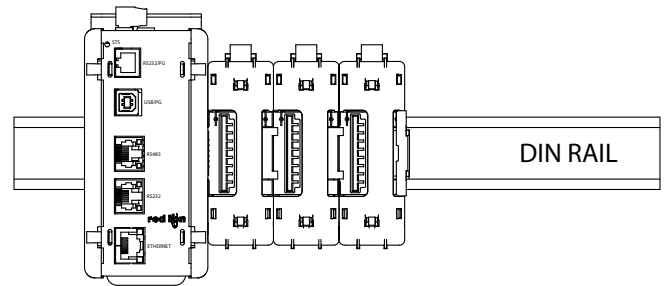

Figure 4 - Installation Complete

POWER SUPPLY REQUIREMENTS

It is very important that the power supply is mounted correctly if the unit is to operate reliably. Please take care to observe the following points:

- The power supply must be mounted close to the unit, with usually not more than 6 feet (1.8 m) of cable between the supply and the master. Ideally, the shortest length possible should be used.
- The wire used to connect the master's power supply should be at least 22-gage wire. If a longer cable run is used, a heavier gage wire should be used. The routing of the cable should be kept away from large contactors, inverters, and other devices which may generate significant electrical noise.
- A power supply with an NEC Class 2 or Limited Power Source (LPS) and SELV rating is to be used. This type of power supply provides isolation to accessible circuits from hazardous voltage levels generated by a mains power supply due to single faults. SELV is an acronym for "safety extra-low voltage." Safety extra-low voltage circuits shall exhibit voltages safe to touch both under normal operating conditions and after a single fault, such as a breakdown of a layer of basic insulation or after the failure of a single component has occurred.

Visit www.redlion.net for a complete list of our PSDR Series of Class 2 power supplies.

EMC INSTALLATION GUIDELINES

Although Red Lion Controls Products are designed with a high degree of immunity to Electromagnetic Interference (EMI), proper installation and wiring methods must be followed to ensure compatibility in each application. The type of the electrical noise, source or coupling method into a unit may be different for various installations. Cable length, routing, and shield termination are very important and can mean the difference between a successful or troublesome installation. Listed are some EMI guidelines for a successful installation in an industrial environment.

1. To reduce the chance of noise spikes entering the unit via the power lines, connections should be made to a clean source. Connecting to circuits that also power loads such as contactors, relays, motors, solenoids etc. should be avoided.
2. The unit should be mounted in a metal enclosure, which is properly connected to protective earth.
3. Use shielded (screened) cables for all Signal and Control inputs. The shield (screen) pigtail connection should be made as short as possible. The connection point for the shield depends somewhat upon the application. Listed below are the recommended methods of connecting the shield, in order of their effectiveness.
 - a. Connect the shield to earth ground (protective earth) at one end where the unit is mounted.
 - b. Connect the shield to earth ground at both ends of the cable, usually when the noise source frequency is over 1 MHz.
 - c. Connect the shield to common of the master and leave the other end of the shield unconnected and insulated from earth ground.

4. Never run Signal or Control cables in the same conduit or raceway with AC power lines, conductors feeding motors, solenoids, SCR controls, and heaters, etc. The cables should be run through metal conduit that is properly grounded. This is especially useful in applications where cable runs are long and portable two-way radios are used in close proximity or if the installation is near a commercial radio transmitter. Also, Signal or Control cables within an enclosure should be routed as far away as possible from contactors, control relays, transformers, and other noisy components.
5. Long cable runs are more susceptible to EMI pickup than short cable runs. Therefore, keep cable runs as short as possible.
6. In extremely high EMI environments, the use of external EMI suppression devices is effective. The following EMI suppression devices (or equivalent) are recommended:

- Ferrite Suppression Cores for signal and control cables:
- Fair-Rite part number 0443167251 (RLC part number FCOR0000)
 - TDK part number ZCAT3035-1330A
 - Steward part number 28B2029-0A0
- Line Filters for input power cables:
- Schaffner part number FN610-1/07 (RLC part number LFIL0000)
 - Schaffner part number FN670-1.8/07
 - Corcom part number 1 VR3

Visit RLC's web site at www.redlion.net for more information on EMI guidelines, Safety and CE issues as they relate to Red Lion Controls products.

WIRING

POWER CONNECTION

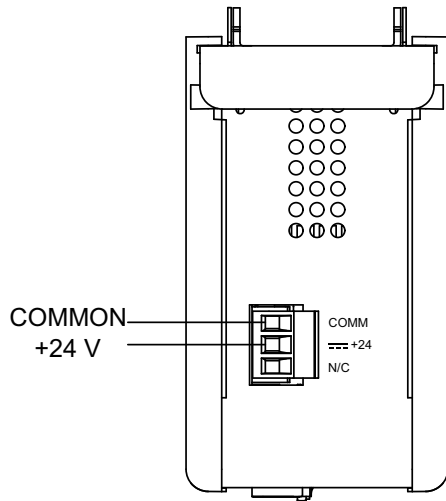

PROGRAMMING PORTS

RS232/PG

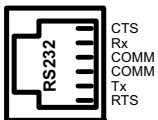

USB/PG

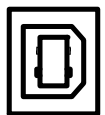

ETHERNET

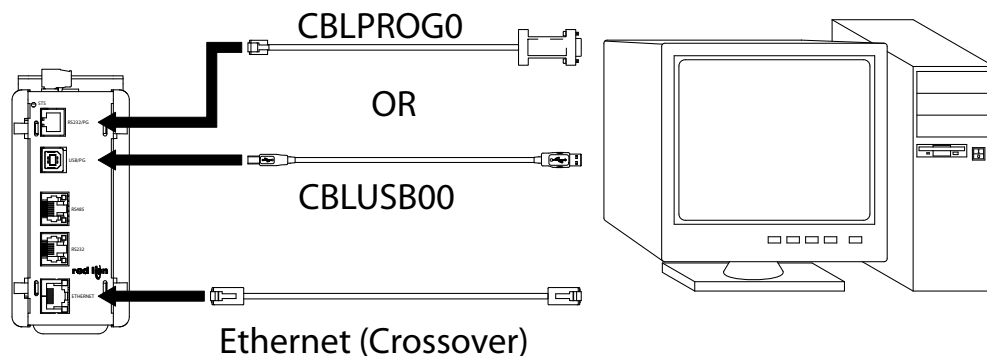

COMMUNICATION PORTS

RS232/PG

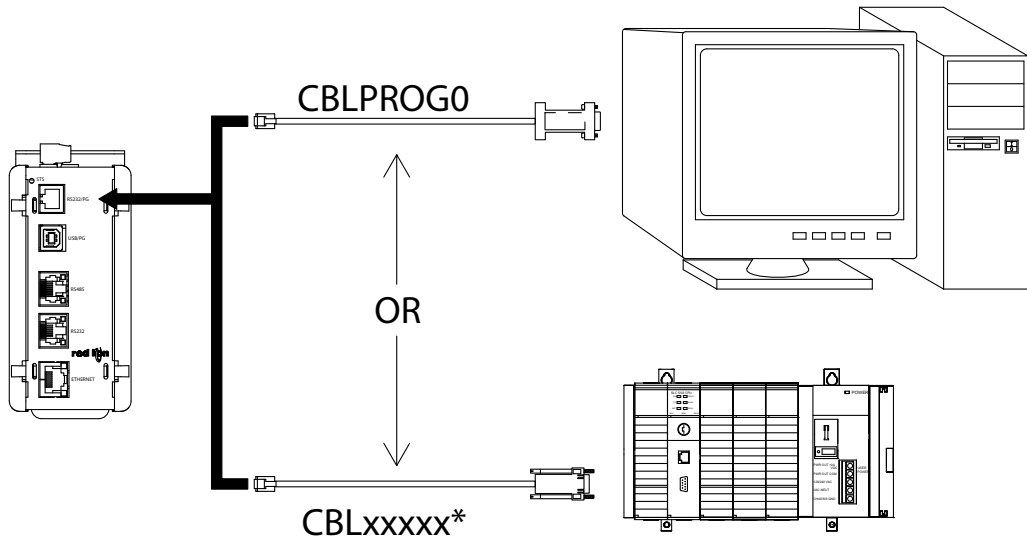
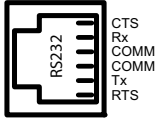

RS232

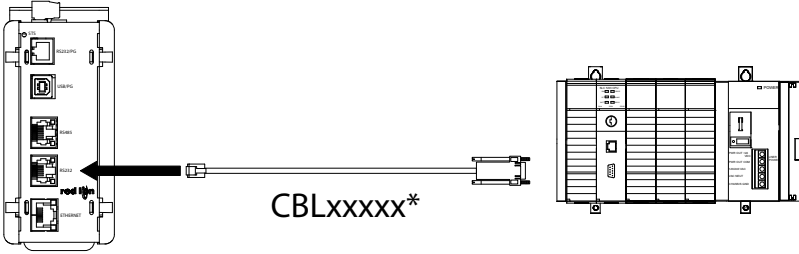
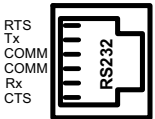

* Use appropriate communications cable. See Ordering Information for descriptions of the available cables.

RS485

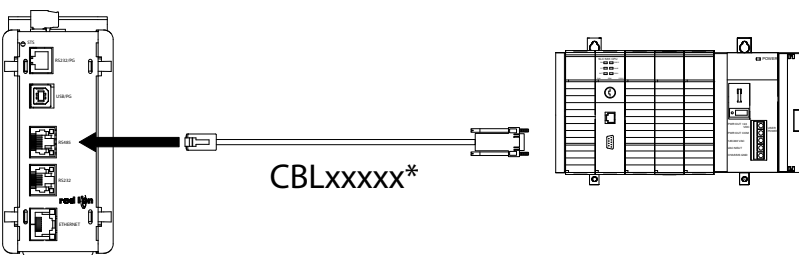
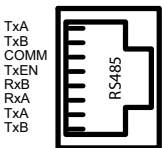

WARNING: Do **NOT** use a standard DH-485 cable to connect this port to Allen Bradley equipment.

PORT 3 - ETHERNET CONNECTION

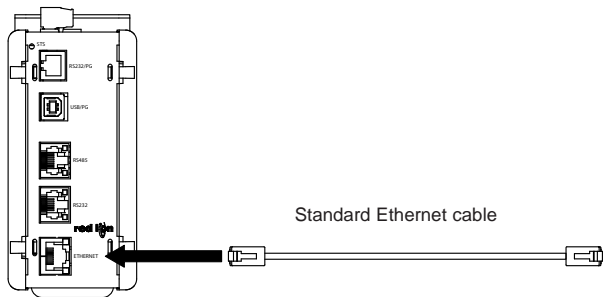

MASTER PORT PIN OUTS

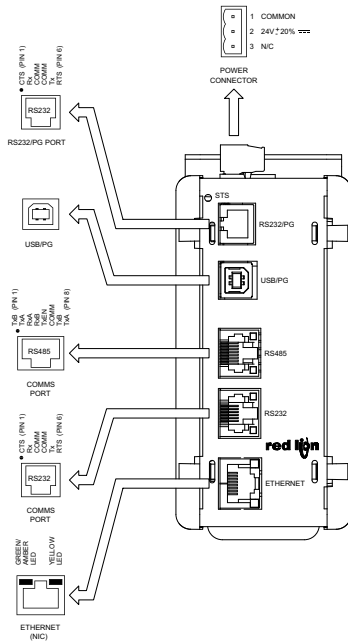

TROUBLESHOOTING

If for any reason you have trouble operating, connecting, or simply have questions concerning your new Master, contact Red Lion's technical support. For contact information, refer to the back page of this bulletin for phone and fax numbers.

EMAIL: techsupport@redlion.net
 Web Site: <http://www.redlion.net>

COMMUNICATING WITH THE MASTER

CONFIGURING A MASTER

The Master is configured using Crimson[®] 2.0 software. Crimson 2.0 is available as a free download from Red Lion's website, or it can be ordered on CD. Updates to Crimson 2.0 for new features and drivers are posted on the website as they become available. By configuring the Master using the latest version of Crimson 2.0, you are assured that your unit has the most up to date feature set. Crimson[®] 2.0 software can configure the Master through the RS232/PG port, USB/PG port, or Ethernet port. The USB/PG port is connected using a standard USB cable with a Type B connector.

The driver needed to use the USB port will be installed with Crimson 2.0. The RS232/PG port uses a programming cable made by Red Lion to connect to the DB9 COM port of your computer. If making your own cable, refer to the "Master Port Pin Outs" for wiring information.

CABLES AND DRIVERS

Red Lion has a wide range of cables and drivers for use with many different communication types. A list of these drivers and cables along with pin outs is available from Red Lion's website. New cables and drivers are added on a regular basis. If making your own cable, refer to the "Master Port Pin Outs" for wiring information.

Note: The USB port is for system set-up and diagnostics and is not intended for permanent connection.

ETHERNET COMMUNICATIONS

Ethernet communications can be established at either 10 BASE-T or 100 BASE-TX. The Master's RJ45 jack is wired as a NIC (Network Interface Card). For example, when wiring to a hub or switch use a straight-through cable, but when connecting to another NIC use a crossover cable.

The Crimson 2.0 manual contains additional information on Ethernet communications.

RS232 PORTS

The Master has two RS232 ports. There is the RS232/PG port and the COMMS port. Although only one of these ports can be used for programming, both ports can be used for communications with a PLC. The RS232/PG port can be used for either master or slave protocols.

RS422/485 PORT

The Master has one RS422/485 port. This port can be configured to act as either RS422 or RS485.

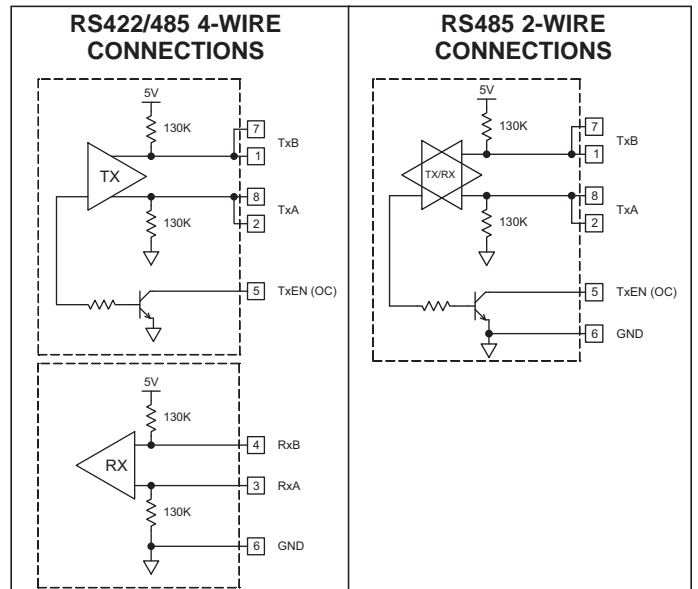

Note: All Red Lion devices connect A to A and B to B, except for Paradigm devices. Refer to www.redlion.net for additional information.

DH485 COMMUNICATIONS

The Master's RS422/485 COMMS port can also be used for Allen Bradley DH485 communications.

WARNING: DO NOT use a standard DH485 cable to connect this port to Allen Bradley equipment. A cable and wiring diagram are available from Red Lion.

LEDS

STS – STATUS LED

The green Status LED provides information regarding the state of the Master, as well as the rest of the system. This includes indication of the various stages of the start-up routine (power-up), and any errors that may occur.

Startup Routine

	INDICATION
Rapidly Flashing	Master is currently running the boot loader and/or being flash upgraded by Crimson.
Steady	Master is operating properly.

Error States

LED	INDICATION
1 blink, pause, repeat	One or more slave modules are missing from the system. Master and installed modules will perform normally in this state.
2 blinks, pause, repeat	Missing configuration, or configuration being updated by Crimson.
3 blinks, pause, repeat	Quantity of module bases does not match configuration file. Master will not communicate with the modules until the error is corrected.
4 blinks, pause, repeat	Termination plug not installed, or one or more bases are malfunctioning. Master will not communicate with the modules until the plug is reinstalled, and power is cycled.

ETHERNET LEDS

LED	INDICATION
YELLOW (Solid)	Link Established
YELLOW (Flashing)	Network Activity
GREEN	10 BASE-T Communications
AMBER	100 BASE-TX Communications

USER COMMUNICATION PORTS - TX/RX LEDS

LED	INDICATION
GREEN	Transmitting
RED	Receiving

Note: LEDs are not available on the Programming Port: RS232/PG.

LIMITED WARRANTY

The Company warrants the products it manufactures against defects in materials and workmanship for a period limited to two years from the date of shipment, provided the products have been stored, handled, installed, and used under proper conditions. The Company's liability under this limited warranty shall extend only to the repair or replacement of a defective product, at The Company's option. The Company disclaims all liability for any affirmation, promise or representation with respect to the products.

The customer agrees to hold Red Lion Controls harmless from, defend, and indemnify RLC against damages, claims, and expenses arising out of subsequent sales of RLC products or products containing components manufactured by RLC and based upon personal injuries, deaths, property damage, lost profits, and other matters which Buyer, its employees, or sub-contractors are or may be to any extent liable, including without limitation penalties imposed by the Consumer Product Safety Act (P.L. 92-573) and liability imposed upon any person pursuant to the Magnuson-Moss Warranty Act (P.L. 93-637), as now in effect or as amended hereafter.

No warranties expressed or implied are created with respect to The Company's products except those expressly contained herein. The Customer acknowledges the disclaimers and limitations contained herein and relies on no other warranties or affirmations.

Red Lion Controls
Headquarters
20 Willow Springs Circle
York PA 17406
Tel +1 (717) 767-6511
Fax +1 (717) 764-0839

Red Lion Controls
Europe
Printerweg 10
NL - 3821 AD Amersfoort
Tel +31 (0) 334 723 225
Fax +31 (0) 334 893 793

Red Lion Controls
India
54, Vishvas Tenement
GST Road, New Ranip,
Ahmedabad-382480 Gujarat, India
Tel +91 987 954 0503
Fax +91 79 275 31 350

Red Lion Controls
China
Unit 101, XinAn Plaza
Building 13, No.99 Tianzhou Road
ShangHai, P.R. China 200223
Tel +86 21 6113-3688
Fax +86 21 6113-3683