

MODEL CUB3T3 & CUB3T4 - GENERAL PURPOSE MINIATURE ELECTRONIC TIMERS

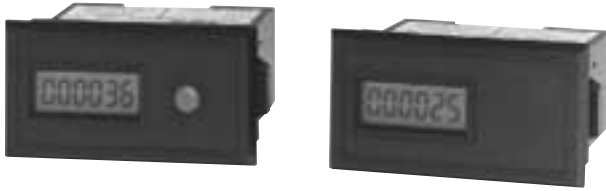

- 6-DIGIT TIMER ACCUMULATES TIME IN HOURS, 1/10 HOURS, 1/100 HOURS, OR 1/10 MINUTES
- OPERATES FROM EITHER SWITCH CONTACT, OR 10 to 300 V (AC 50/60 Hz or DC) INPUTS
- SELF-POWERED WITH INTERNAL LITHIUM BATTERY FOR UP TO 7 YEARS OF CONTINUOUS OPERATION
- AVAILABLE IN FRONT PANEL AND REMOTE RESET OR REMOTE RESET ONLY MODELS
- EASY SNAP-IN MOUNTING IN 1" X 2" (25 mm x 50 mm) PANEL OPENING
- IDEAL FOR PORTABLE, MOBILE, OR STATIONARY INDUSTRIAL EQUIPMENT

DESCRIPTION

The CUB3T's are state-of-the-art products with Micro-Electronic technology. They open up a wide variety of new timing application possibilities that, until now, were economically impractical.

The CUB3T3 and CUB3T4 are designed to be used as hour, tenth hour, hundredth hour or tenth minute timers. The timing function on both models can be activated by either a contact closure or the application of 10 to 300 (AC 50/60 Hz or DC). Both models are equipped with a remote reset. The CUB3T4 has the additional feature of a front panel reset. Time is displayed on a 6 digit LCD that will wrap around from a full display of "999999" to "000000" when an overflow occurs. An indicator, located in the upper lefthand corner of the display, will blink at 2 Hz whenever the timer is actuated. The front panel reset feature of the CUB3T4 allows the user to periodically measure elapsed time. The CUB3T3, on the other hand, is ideally suited for measuring total run time.

Application of the CUB3T is simplicity itself. Its rugged reinforced nylon case snap-fits into a standard rectangular opening without screws or other hardware. No external power source is required since the internal lithium battery provides up to 7 years of uninterrupted service. In addition to these advantages, the CUB3T offers integrated circuitry, embedded in a single monolithic, silicon micro-chip.

SAFETY SUMMARY

All safety related regulations, local codes and instructions that appear in this bulletin or on equipment must be observed to ensure personal safety and to prevent damage to either the instrument or equipment connected to it. If equipment is used in a manner not specified by the manufacturer, the protection provided by the equipment may be impaired.

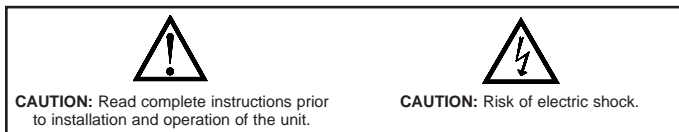

 **Metal panel must be connected to protective earth ground.**

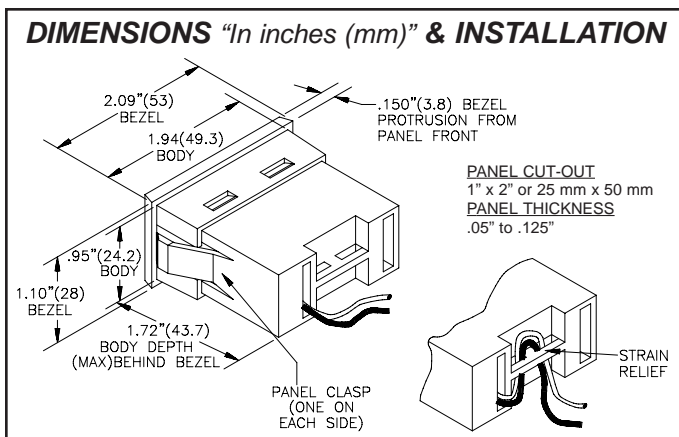

SPECIFICATIONS

1. **DISPLAY:** 6-Digit, LCD, 0.2" (5.1 mm) High.
2. **POWER:** 3 Volts supplied by a non-replaceable lithium battery. Nominal battery life is 7 years. Battery life is dependent upon usage. Signal and reset contacts that remain closed for long periods of time reduce battery life.
3. **REMOTE RESET:**
50 msec min. pulse width (active low) from 3.0 V bi-polar output, an open collector transistor, or a switch contact to common.
 $V_{IH} = 2.0$ V min. (3 V max), $V_{IL} = 0.5$ V max.
4. **SIGNAL INPUT:**
Contact Connections: Switch Contact or Solid-State Transistor Switch. Contact burden 15 pamps max. A maintained closed switch will actuate the timer.
10 to 300 V Connections: 10 V min. to 300 V max. (AC 50/60 Hz or DC). Input current 0.5 mA max. Constant voltage applied to the inputs will actuate the timer.

5. CERTIFICATIONS AND COMPLIANCES:

SAFETY

EN 61010-1, IEC 1010-1

Safety requirements for electrical equipment for measurement, control, and laboratory use, Part I.

ELECTROMAGNETIC COMPATIBILITY

Immunity to EN 50082-2

Electrostatic discharge	EN 61000-4-2	Level 2; 4 Kv contact ¹ Level 3; 8 Kv air
Electromagnetic RF fields	EN 61000-4-3	Level 3; 10 V/m 80 MHz - 1 GHz
Fast transients (burst)	EN 61000-4-4	Level 4; 2 Kv I/O ²
RF conducted interference	EN 61000-4-6	Level 3; 10 V/rms 150 KHz - 80 MHz

Emissions to EN 50081-1

RF interference	EN 55022	Enclosure class B
-----------------	----------	-------------------

Notes:

1. For operation without loss of performance:
In static environments above 4 KV, typical anti-static precautions should be observed before touching the bezel.
2. For operation without loss of performance:
Install 1 ferrite core, RLC#FCOR0000 or equivalent, to cables at unit.
OR
Route I/O cables in metal conduit connected to earth ground.
Refer to the EMC Installation Guidelines for additional information.

6. ENVIRONMENTAL CONDITIONS:

Operating Temperature: -25 to +75°C

Storage Temperature: -30 to 75°C

Operating and Storage Humidity: 85% max. RH (non-condensing) from -25°C to +75°C.

Altitude: Up to 2000 meters

7. **CONSTRUCTION:** Installation Category II, Pollution Degree 2.

8. **ACCURACY:** 0.025%

9. **WEIGHT:** 2 oz (56.7 g)

EMC INSTALLATION GUIDELINES

Although this unit is designed with a high degree of immunity to ElectroMagnetic Interference (EMI), proper installation and wiring methods must be followed to ensure compatibility in each application. The type of the electrical noise, source or coupling method into the unit may be different for various installations. Cable length, routing and shield termination are very important and can mean the difference between a successful or a troublesome installation. Listed below are some EMC guidelines for successful installation in an industrial environment.

- Use shielded (screened) cables for all Signal and Control inputs. The shield (screen) pigtail connection should be made as short as possible. The connection point for the shield depends somewhat upon the application. Listed below are the recommended methods of connecting the shield, in order of their effectiveness.
 - Connect the shield only at the panel where the unit is mounted to earth ground (protective earth).
 - Connect the shield to earth ground at both ends of the cable, usually when the noise source frequency is above 1 MHz.
- Never run Signal or Control cables in the same conduit or raceway with AC power lines, conductors feeding motors, solenoids, SCR controls, and heaters, etc. The cables should be run in metal conduit that is properly grounded. This is especially useful in applications where cable runs are long and portable two-way radios are used in close proximity or if the installation is near a commercial radio transmitter.
- Signal or Control cables within an enclosure should be routed as far away as possible from contactors, control relays, transformers, and other noisy components.
- In extremely high EMI environments, the use of external EMI suppression devices, such as ferrite suppression cores, is effective. Install them on Signal and Control cables as close to the unit as possible. Loop the cable through the core several times or use multiple cores on each cable for additional protection. The following EMI suppression devices (or equivalent) are recommended:

Ferrite Suppression Cores for signal and control cables:

Fair-Rite # 0443167251 (RLC #FCOR0000)

TDK # ZCAT3035-1330A

Steward #28B2029-0A0

- Long cable runs are more susceptible to EMI pickup than short cable runs. Therefore, keep cable runs as short as possible.

TYPICAL APPLICATIONS

An equipment rental company charges customers by the hour for the rental of forklifts or other heavy equipment. To help determine the amount of actual run time, a CUB3T300 is connected to a spare set of contacts on the ignition switch of the forklift. When the switch is in the "RUN" position, the "Orn/Whit" and "White" leads of the CUB3T3 are connected, which cause it to accumulate time in hours on the display. The rental company simply resets the CUB3T3 by momentarily closing the connection between the "Orn/Whit" and "Blue" leads before each rental period. The normally open "REMOTE RESET" push-button (installed by the rental company) is protected to prevent tampering by the customer.

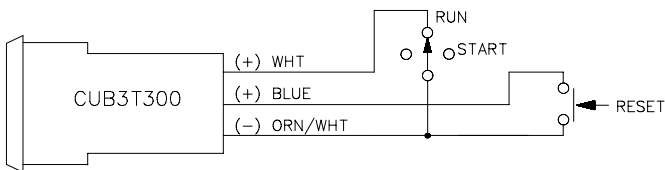

A machine shop manager charges customers for machine time by the hour. He is also interested in tracking machine run time vs. down time. A CUB3T310 connected across the 115 VAC spindle motor of a drill press will serve both purposes. A reading taken before and after each job will indicate the actual machine run time in tenth hour increments. A reading at the beginning and end of each shift will indicate total run time, allowing the manager to evaluate production efficiency and down time.

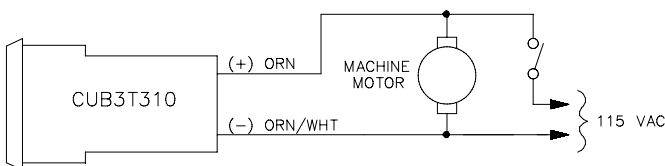

ELECTRICAL CONNECTIONS & INPUTS

All conductors should meet voltage and current ratings for each terminal. Also, cabling should conform to appropriate standards of good installation, local codes and regulations. It is recommended that voltage connections to the unit be protected by a fuse or circuit breaker.

The CUB3T's can be supplied with input signals from mechanical switch contacts or solid-state switches as shown in the diagrams below. Reed switches, mercury-wetted contacts, snap-action limit switches, and silver alloy contacts with wiping action are usually satisfactory choices for mechanical switch input. Heavy "clapper-type" contacts such as used in contactors or large machine tool relays, tungsten contacts, or brush type contacts are not recommended for the low level switching used by the input to the timer.

To avoid injury to personnel or equipment, properly isolate all unused wires. For example, wire nuts, closed end splices, or other types of wire terminators should be used.

Warning: Connecting voltage to contact or reset inputs will cause damage to the unit.

10 to 300 V Voltage Connections



Warning: Any lead may be at hazardous live input potential. External wiring and devices connected to the unit must be rated the same as applied signal input voltage and be properly isolated from Class 2 or SELV circuitry.

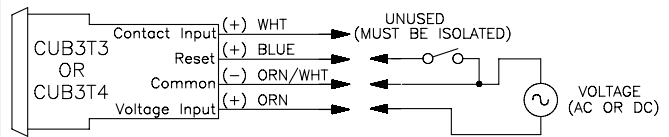

Contact Connections

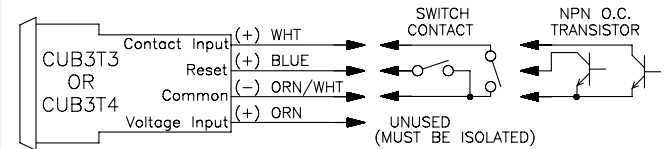

Installation Environment

The unit should be installed in a location that does not exceed the maximum operating temperature and provides good air circulation. Placing the unit near devices that generate excessive heat should be avoided.

The bezel should be cleaned only with a neutral soap product applied to a soft damp cloth. Do NOT use solvents.

Continuous exposure to direct sunlight may accelerate the aging process of the display.

Do not use tools of any kind (screwdriver, pens, pencils, etc.) to operate the reset button of this unit.

TROUBLESHOOTING

For further technical assistance, contact technical support at the appropriate company numbers.



WARNING: Lithium battery may explode if incinerated. Input voltage must not exceed 3.0 VDC on contact input or maximum rated voltage on voltage input to prevent damage to the unit.

ORDERING INFORMATION

MODEL NO.	DESCRIPTION	PART NUMBER
CUB3T3	Timer, 1 hr.; Remote Reset Only	CUB3T300
	Timer, 0.1 hr.; Remote Reset Only	CUB3T310
	Timer, 0.01 hr.; Remote Reset Only	CUB3T320
	Timer, 0.1 min.; Remote Reset Only	CUB3T330
CUB3T4	Timer, 1 hr. w/Front Panel and Remote Reset	CUB3T400
	Timer, 0.1 hr. w/Front Panel and Remote Reset	CUB3T410
	Timer, 0.01 hr. w/Front Panel and Remote Reset	CUB3T420
	Timer, 0.1 min. w/Front Panel and Remote Reset	CUB3T430