



EAO Product Information

Series 61



Description 5

Product Assembly 6

Mounting instruction 11

Devices raised mounting 12

Devices flush mounting 20

Accessories 27

Technical Data 43

Typical Applications 47

Marking 49

Drawings 52

Index 69

Product Information

General notes

The indicators, illuminated pushbuttons, selector-, keylock switches or emergency-stop switches with spray-water protection at the front (IP 65) are modular and consist of an actuator and switching element.

In addition to the standard switching elements (gold-plated silver contact with universal soldering terminals), forced-opening, slow-make switching elements with gold or silver contacts with soldering terminals are available. EAO can also offer screw terminals on its slow make elements. Switching elements with soldering terminals can also be fitted with flat receptacle 2.8 x 0.5 mm

The front dimensions of the units in this series are 24 x 24 mm, 24 mm dia., 18 x 24 mm, 18 x 18 mm or 18 mm dia. For flush mounting the dimensions 25 mm dia., 24 x 30 mm or 24 x 24 mm can be supplied.

Mounting

All switch actuators are mounted from the front by pushing them through the mounting hole in the front panel. They are then fixed from the back with a fixing nut and the mounting tool Typ-Nr. 01-907. Max. tightening torque 50 Ncm.

The preassembled switching element with the connecting wires in a single plane can be clipped on afterwards. A range of assembly and service tools are available.

PCB mounting adaptors are available for universal solder terminal switching elements.

All raised profile actuators are provided with an anti-twist device.

Lenses

The flat or concave lenses are available in various colours and a transparent or translucent version. The lens surface is non-reflecting (matt). Round lenses for devices 24 mm dia. or 25 mm dia. can also be supplied in aluminium.

Marking

For further information about engraving, hot stamping and film inserts see part Marking.

Illumination

T1 ³/₄ midget groove LED's in red, blue, green, yellow and white or filament lamps give superb illumination and can be supplied in 6, 12, 24, or 48 V.

Luminosity and wave length scattering caused by the technology used in the LED manufacturing processes may lead to visual differences in our products.

Position indication

The status of a maintained action switch can be determined by the position of the lens.

Keylock switch

Standard lock (Index D). Standard lock number is 311. If the lock number is not specified, we will supply standard number 311.

An additional 134 special locks (Index X) are available on request. Master keys for lock numbers 311...445 may be ordered by quoting Typ-Nr. 31-989.300. Two keys are supplied with each keylock switch. Spare keys (Index D) for standard locks may be ordered by quoting Typ-Nr. 31-989.xxx (please state the lock number).

Emergency-stop pushbutton, foolproof with key to release

KABA safety lock. Standard lock number is 1001. Other lock numbers are available on request. Spare keys for KABA safety lock may be ordered under Typ-Nr. 14-987.xxx (please state the lock number).

Specimen order

Indicator :

- Indicator complete, flush mounting, 24 x 24 mm 61-0000.02

Essential accessories :

- Lens plastic colourless transparent flush, 24 x 24 mm 61-9671.7
 - Single-LED T1 ³/₄ MG, 24 VDC, white diffuse 10-2J12.1069
 - Front bezel set for Indicator, flush mounting, plastic black, 24 x 24 mm 61-9930.0

*We reserve the right to modify technical data
 All dimensions in mm*

Pushbutton illuminative, raised mounting

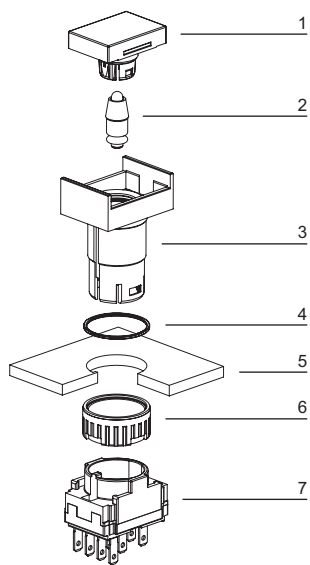

- 1 Lens
- 2 LED
- 3 Actuator housing
- 4 Sealing
- 5 Front plate
- 6 Fixing nut
- 7 Switching element

Emergency-stop pushbutton

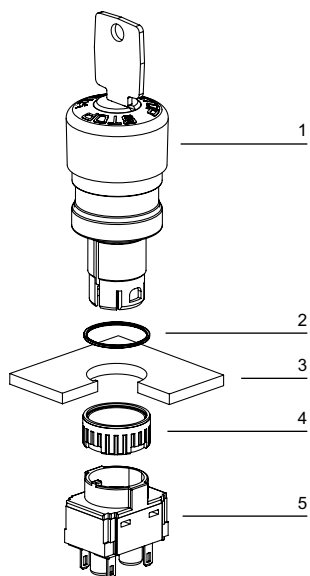

- 1 Emergency-stop pushbutton actuator
- 2 Sealing
- 3 Front plate
- 4 Fixing nut
- 5 Switching element

Mushroom-head pushbutton, raised mounting

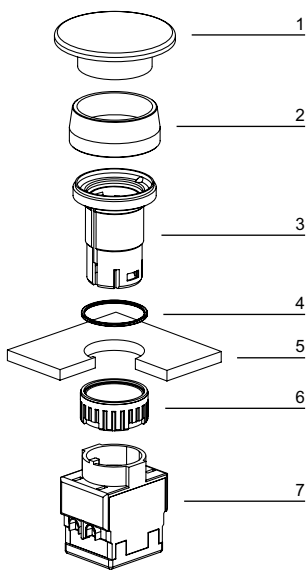

- 1 Mushroom-head cap
- 2 Front ring
- 3 Actuator housing
- 4 Sealing
- 5 Front plate
- 6 Fixing nut
- 7 Switching element

Keylock switch, raised mounting

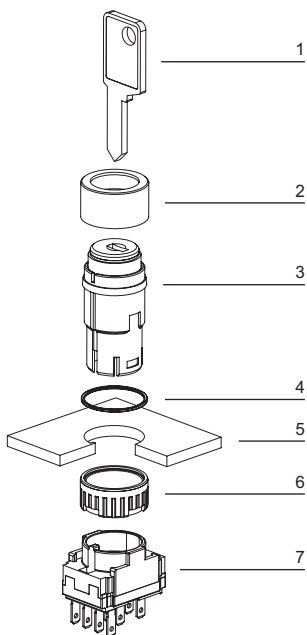

- 1 Key
- 2 Keylock front bezel
- 3 Keylock switch actuator
- 4 Sealing
- 5 Front plate
- 6 Fixing nut
- 7 Switching element

Selector switch illuminative, raised mounting

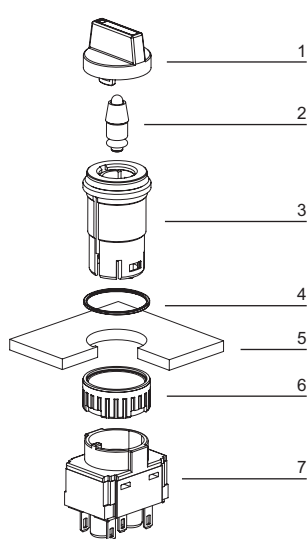

- 1 Lever
- 2 LED
- 3 Selector switch actuator
- 4 Sealing
- 5 Front plate
- 6 Fixing nut
- 7 Switching element

Pushbutton illuminative, flush mounting

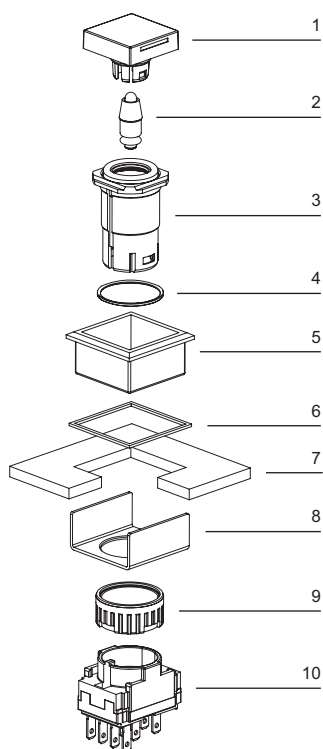

- 1 Lens
- 2 LED
- 3 Actuator housing
- 4 Sealing
- 5 Front bezel
- 6 Sealing
- 7 Front panel
- 8 Fixing bracket
- 9 Fixing nut
- 10 Switching element

Keylock switch, flush mounting

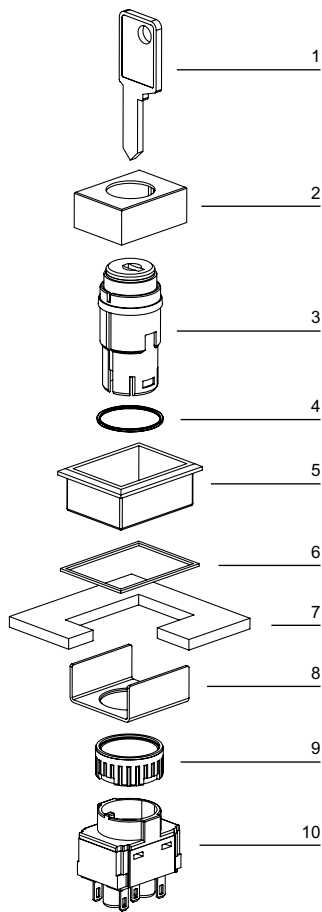

- 1 Key
- 2 Keylock front bezel
- 3 Keylock switch actuator
- 4 Sealing
- 5 Front bezel
- 6 Sealing
- 7 Front plate
- 8 Fixing bracket
- 9 Fixing nut
- 10 Switching element

Selector switch illuminative, flush mounting

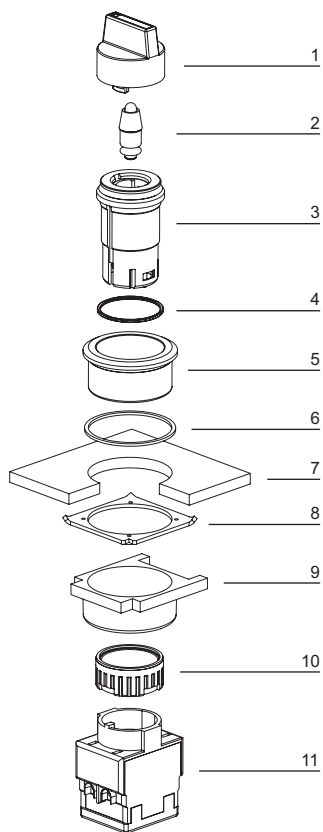

- 1 Lever
- 2 LED
- 3 Selector switch actuator
- 4 Sealing
- 5 Front bezel
- 6 Sealing
- 7 Front plate
- 8 Anti-twist ring
- 9 Thrust piece
- 10 Fixing nut
- 11 Switching element

Tool set

Lens remover, Mounting tool, Dismantling tool with Lamp- and LED remover are part of the Tool set K61-999.100

raised mounting

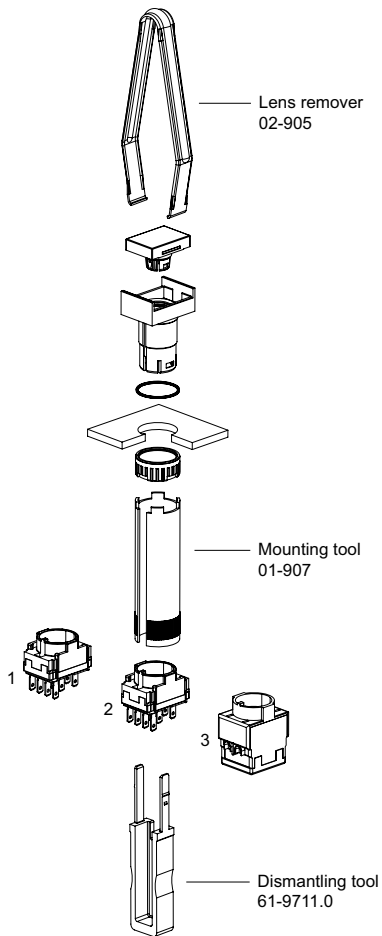

flush mounting

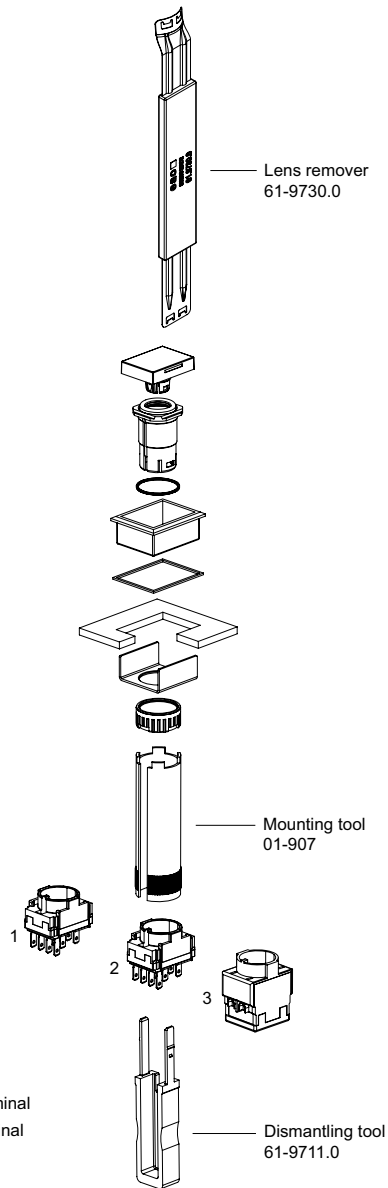





- 1 Snap-action switching element with soldering terminal
- 2 Slow-make switching element with soldering terminal
- 3 Slow-make switching element with screw terminal

Indicator complete



Essential Accessories:

-  Front ring, raised mounting page 32
-  Lens plastic, raised mounting page 27
-  Single-LED page 39

	Front protection	Terminals	\varnothing 24 x 24 mm Typ-Nr.	\varnothing 18 x 18 mm Typ-Nr.	\varnothing 18 x 24 mm Typ-Nr.	\varnothing 24 mm Typ-Nr.	\varnothing 18 mm Typ-Nr.	Mounting dimensions	Technical drawing	Circuit drawing	
Indicator complete Actuator housing black	IP 65	S1	61-0050.02	61-0020.02	61-0030.02	61-0040.02	61-0010.02	1	3	4	0.005







Terminals: S1 = Soldering terminal (also pluggable 2.8 x 0.5 mm)

Mounting dimensions from page 57, Technical drawing from page 58, Circuit drawing from page 64

Indicator actuator



Essential Accessories:

-  Diode element page 35
-  Flasher element page 35
-  Front ring, raised mounting page 32
-  Lamp element page 34
-  Lens plastic, raised mounting page 27
-  Single-LED page 39





	Front protection	\varnothing 24 x 24 mm Typ-Nr.	\varnothing 18 x 18 mm Typ-Nr.	\varnothing 18 x 24 mm Typ-Nr.	\varnothing 24 mm Typ-Nr.	\varnothing 18 mm Typ-Nr.	Mounting dimensions	Technical drawing	Circuit drawing	
Indicator actuator Actuator housing black	IP 65	61-0059.0	61-0029.0	61-0039.0	61-0049.0	61-0019.0	1	12	4	0.005

Mounting dimensions from page 57, Technical drawing from page 58, Circuit drawing from page 64

Illuminated pushbutton actuator



Essential Accessories:

-  Front ring, raised mounting page 32
-  Lens plastic, raised mounting page 27
-  Single-LED page 39
-  Switching element for Pushbutton | Keylock- and Selector switch 2 positions page 36

	Front protection	Switching action	∅ 24 x 24 mm Typ-Nr.	∅ 18 x 18 mm Typ-Nr.	∅ 18 x 24 mm Typ-Nr.	∅ 24 mm Typ-Nr.	∅ 18 mm Typ-Nr.	Mounting dimensions	Technical drawing	Circuit drawing	
Illuminated pushbutton actuator Actuator housing black	IP 65	MA	61-1250.0	61-1220.0	61-1230.0	61-1240.0	61-1210.0	1	14	6	0.005
		M	61-1150.0	61-1120.0	61-1130.0	61-1140.0	61-1110.0	1	14	13	0.005
		M-MA	61-1350.0	61-1320.0	61-1330.0		61-1310.0	1	14	13	0.005

M-MA convertible from Momentary to Maintained action

Switching action: MA = Maintained action, M = Momentary action, M-MA = Momentary action-Maintained action

Mounting dimensions from page 57, Technical drawing from page 58, Circuit drawing from page 64

Emergency-stop pushbutton actuator, foolproof EN IEC 60947-5-5

Application as per EN 60204-1 and EN 418



Essential Accessories:

 Switching element for Emergency-stop pushbutton page 37

	Front protection	Switching action	Mushroom head cap	Marking	Ø 27 mm Typ-Nr.	Mounting dimensions	Technical drawing	Circuit drawing	
Emergency-stop pushbutton actuator, foolproof EN IEC 60947-5-5 Position indication ring black Key to unlock clockwise Standard lock 1001	IP 65	MA	Plastic red	Stop	61-5441.4/K	2	17	5	0.033
Position indication ring black Twist to unlock clockwise	IP 65	MA	Plastic red	Arrows	61-3440.4/1	2	17	5	0.020
				Stop	61-3440.4/2	2	17	5	0.020
Position indication ring black Twist to unlock clockwise with adaptor for mosaic	IP 65	MA	Plastic red	Arrows	61-3440.4/1S	2	17	5	0.021
Position indication ring black Twist to unlock clockwise with metal Fixing nut	IP 65	MA	Plastic red	Arrows	61-3440.4/D	2	17	5	0.020
Position indication ring green Twist to unlock clockwise	IP 65	MA	Plastic red	Arrows	61-3440.4/5	2	17	5	0.020

Other lock numbers on request

Switching action: MA = Maintained action

Mounting dimensions from page 57, Technical drawing from page 58, Circuit drawing from page 64

Emergency-stop pushbutton actuator, foolproof

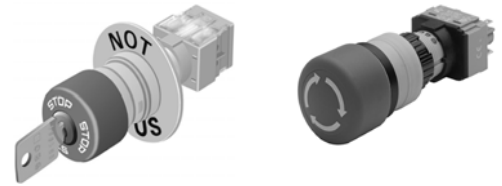

Essential Accessories:

- Shopping cart icon Switching element for Emergency-stop pushbutton page 37

	Front protection	Switching action			Ø 27 mm Typ-Nr.	Mounting dimensions	Technical drawing	Circuit drawing	
Emergency-stop pushbutton actuator, foolproof Position indication ring black Key to unlock clockwise Standard lock 1001	IP 65	MA	Mushroom had cap	Marking	61-5441.0/K	2	17	5	0.033
Position indication ring black Twist to unlock clockwise	IP 65	MA	Plastic grey	Arrows	61-3440.4/8	2	17	5	0.020

Other lock numbers on request

Switching action: MA = Maintained action

Mounting dimensions from page 57, Technical drawing from page 58, Circuit drawing from page 64

Mushroom-head pushbutton actuator



Essential Accessories:

- Shopping cart icon Front ring, raised mounting page 32
- Shopping cart icon Mushroom-head cap page 29
- Shopping cart icon Switching element for Pushbutton | Keylock- and Selector switch 2 positions page 36

	Front protection	Switching action	Ø 32 mm Typ-Nr.	Mounting dimensions	Technical drawing	Circuit drawing	
Mushroom-head pushbutton actuator Actuator housing black	IP 65	MA	61-1240.0	2	13	6	0.005
		M	61-1140.0	2	13	13	0.005

Switching action: MA = Maintained action, M = Momentary action



Mounting dimensions from page 57, Technical drawing from page 58, Circuit drawing from page 64

Keylock switch actuator 2 positions

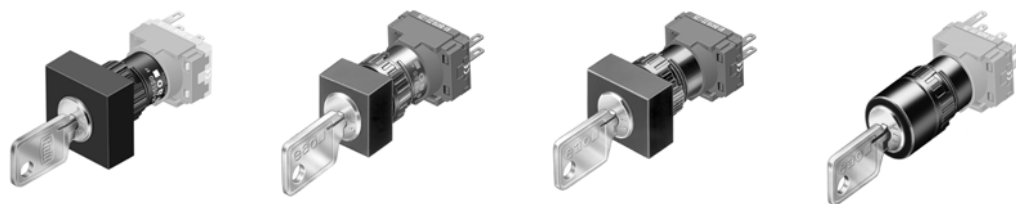
if mounted with anti-twist device, the lug is on the left side



Essential Accessories:

-  Anti-twist ring page 41
-  Keylock front bezel, raised mounting page 29
-  Switching element for Pushbutton | Keylock- and Selector switch 2 positions page 36

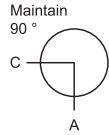
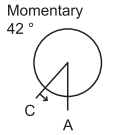
	Front protection	Switching action	Key remove	Ø 24 x 24 mm Typ-Nr.	Ø 18 x 18 mm Typ-Nr.	Ø 18 x 24 mm Typ-Nr.	Ø 18 mm Typ-Nr.	Mounting dimensions	Technical drawing	Circuit drawing	
Maintain 90° 	IP 65	MA	A	61-2201.0/D	61-2201.0/D	61-2201.0/D	61-2201.0/D	1	15	17	0.065
			C	61-2203.0/D	61-2203.0/D	61-2203.0/D	61-2203.0/D	1	15	17	0.065
			C + A	61-2205.0/D	61-2205.0/D	61-2205.0/D	61-2205.0/D	1	15	17	0.065
Momentary 42° 	IP 65	M	A	61-2101.0/D	61-2101.0/D	61-2101.0/D	61-2101.0/D	1	15	16	0.065

Other lock numbers on request

Anti-twist ring (not needed by using anti-twist device)

Switching action: MA = Maintained action, M = Momentary action



Mounting dimensions from page 57, Technical drawing from page 58, Circuit drawing from page 64

Keylock switch actuator 3 positions

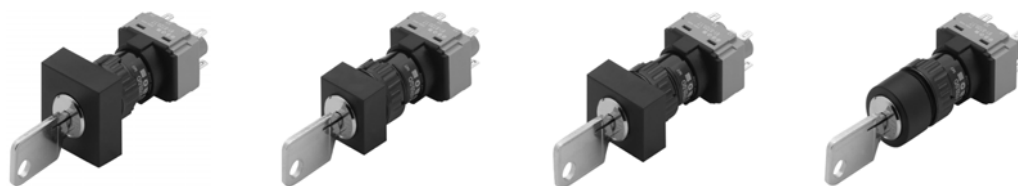
if mounted with anti-twist device, the lug is on the left side



Essential Accessories:

-  Anti-twist ring page 41
-  Keylock front bezel, raised mounting page 29
-  Switching element for Keylock- and Selector switch 3 positions page 37

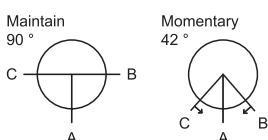

	Front protection	Switching action	Key remove	Ø 24 x 24 mm Typ-Nr.	Ø 18 x 18 mm Typ-Nr.	Ø 18 x 24 mm Typ-Nr.	Ø 18 mm Typ-Nr.	Mounting dimensions	Technical drawing	Circuit drawing	
Keylock switch actuator 3 positions Pos. C: Maintained action Pos. A: Basic position Pos. B: Maintained action Standard lock 311	IP 65	MA-O-MA	A	61-2601.0/D	61-2601.0/D	61-2601.0/D	61-2601.0/D	1	15	19	0.065
			A + B	61-2604.0/D	61-2604.0/D	61-2604.0/D	61-2604.0/D	1	15	19	0.065
			B	61-2602.0/D	61-2602.0/D	61-2602.0/D	61-2602.0/D	1	15	19	0.065
			C	61-2603.0/D	61-2603.0/D	61-2603.0/D	61-2603.0/D	1	15	19	0.065
			C + A	61-2605.0/D	61-2605.0/D	61-2605.0/D	61-2605.0/D	1	15	19	0.065
			C + A + B	61-2607.0/D	61-2607.0/D	61-2607.0/D	61-2607.0/D	1	15	19	0.065
Pos. C: Maintained action Pos. A: Basic position Pos. B: Momentary action Standard lock 311	IP 65	MA-O-M	A	61-2701.0/D	61-2701.0/D	61-2701.0/D	61-2701.0/D	1	15	18	0.065
			C	61-2703.0/D	61-2703.0/D	61-2703.0/D	61-2703.0/D	1	15	18	0.065
			C + A	61-2705.0/D	61-2705.0/D	61-2705.0/D	61-2705.0/D	1	15	18	0.065
Pos. C: Momentary action Pos. A: Basic position Pos. B: Maintained action Standard lock 311	IP 65	M-O-MA	A + B	61-2804.0/D	61-2804.0/D	61-2804.0/D	61-2804.0/D	1	15	15	0.065
			B	61-2802.0/D	61-2802.0/D	61-2802.0/D	61-2802.0/D	1	15	15	0.065
Pos. C: Momentary action Pos. A: Basic position Pos. B: Maintained action Standard lock 311	IP 65	M-O-MA	A	61-2801.0/D	61-2801.0/D	61-2801.0/D	61-2801.0/D	1	15	15	0.065
Pos. C: Momentary action Pos. A: Basic position Pos. B: Momentary action Standard lock 311	IP 65	M-O-M	A	61-2501.0/D	61-2501.0/D	61-2501.0/D	61-2501.0/D	1	15	14	0.065

Other lock numbers on request

Anti-twist ring (not needed by using anti-twist device)

Switching action: MA = Maintained action, M = Momentary action

Mounting dimensions from page 57, Technical drawing from page 58, Circuit drawing from page 64





Selector switch actuator 2 positions

illuminative

if mounted with anti-twist device, the lug is on the left side



Essential Accessories:

-  Anti-twist ring page 41
-  Lever, raised mounting page 29
-  Single-LED page 39
-  Switching element for Pushbutton | Keylock- and Selector switch 2 positions page 36

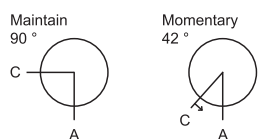

	Front protection	Switching action	26 x 26 mm Typ-Nr.	24 x 24 mm Typ-Nr.	Ø 18 mm Typ-Nr.	Mounting dimensions	Technical drawing	Circuit drawing	
Selector switch actuator 2 positions Position C: Maintained action Position A: Basic position	IP 65	MA	61-4210.0	61-4210.0	61-4210.0	1	16	8	0.006
Position C: Momentary action Position A: Basic position	IP 65	M	61-4110.0	61-4110.0	61-4110.0	1	16	7	0.006

Anti-twist ring (not needed by using anti-twist device)

Switching action: MA = Maintained action, M = Momentary action

Mounting dimensions from page 57, Technical drawing from page 58, Circuit drawing from page 64



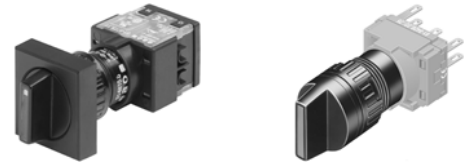

Selector switch actuator 3 positions

illuminative

if mounted with anti-twist device, the lug is on the left side



Essential Accessories:

-  Anti-twist ring page 41
-  Filament lamp page 39
-  Lever, raised mounting page 29
-  Single-LED page 39
-  Switching element for Keylock- and Selector switch 3 positions page 37

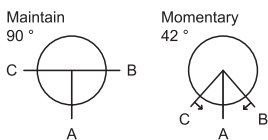

	Front protection	Switching action	\varnothing 26 x 26 mm Typ-Nr.	\varnothing 24 x 24 mm Typ-Nr.	\varnothing 18 mm Typ-Nr.	Mounting dimensions	Technical drawing	Circuit drawing	
Selector switch actuator 3 positions Position C: Maintained action Position A: Basic position Position B: Maintained action	IP 65	MA-O-MA	61-4610.0	61-4610.0	61-4610.0	1	16	12	0.006
Position C: Maintained action Position A: Basic position Position B: Momentary action	IP 65	MA-O-M	61-4710.0	61-4710.0	61-4710.0	1	16	11	0.006
Position C: Momentary action Position A: Basic position Position B: Maintained action	IP 65	M-O-MA	61-4810.0	61-4810.0	61-4810.0	1	16	10	0.006
Position C: Momentary action Position A: Basic position Position B: Momentary action	IP 65	M-O-M	61-4510.0	61-4510.0	61-4510.0	1	16	9	0.006



Switching action: MA = Maintained action, M = Momentary action

Mounting dimensions from page 57, Technical drawing from page 58, Circuit drawing from page 64

Indicator complete, flush mounting



Essential Accessories:

-  Front bezel set for Indicators and Illuminated pushbutton, flush mounting page 31
-  Lens plastic, flush mounting page 27
-  Single-LED page 39

	Front protection	Terminals	□ 24 x 24 mm Typ-Nr.	□ 24 x 30 mm Typ-Nr.	Ø 25 mm Typ-Nr.	Mounting dimensions	Technical drawing	Circuit drawing	
Indicator complete, flush mounting	IP 65	S1	61-0000.02	61-0000.02	61-0000.02	3	4	4	0.006







Terminals: S1 = Soldering terminal (also pluggable 2.8 x 0.5 mm)

Mounting dimensions from page 57, Technical drawing from page 58, Circuit drawing from page 64

Indicator actuator, flush mounting



Essential Accessories:

-  Diode element page 35
-  Flasher element page 35
-  Front bezel set for Indicators and Illuminated pushbutton, flush mounting page 31
-  Lamp element page 34
-  Lens plastic, flush mounting page 27
-  Single-LED page 39



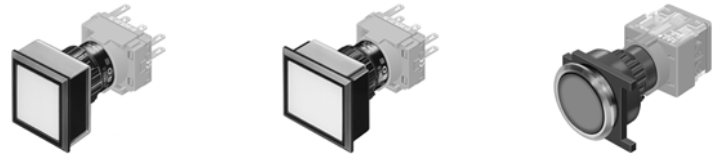

	Front protection	□ 24 x 24 mm Typ-Nr.	□ 24 x 30 mm Typ-Nr.	Ø 25 mm Typ-Nr.	Mounting dimensions	Technical drawing	Circuit drawing	
Indicator actuator, flush mounting	IP 65	61-0009.0	61-0009.0	61-0009.0	3	19	4	0.005

Mounting dimensions from page 57, Technical drawing from page 58, Circuit drawing from page 64

Illuminated pushbutton actuator, flush mounting



Essential Accessories:

-  Front bezel set for Indicators and Illuminated pushbutton, flush mounting page 31
-  Lens plastic, flush mounting page 27
-  Single-LED page 39
-  Switching element for Pushbutton | Keylock- and Selector switch 2 positions page 36

	Front protection	Switching action	□ 24 x 24 mm Typ-Nr.	□ 24 x 30 mm Typ-Nr.	∅ 25 mm Typ-Nr.	Mounting dimensions	Technical drawing	Circuit drawing	
Illuminated pushbutton actuator, flush mounting	IP 65	MA	61-1200.0	61-1200.0	61-1200.0	3	18	2	0.005
		M	61-1100.0	61-1100.0	61-1100.0	3	18	3	0.005
		M-MA	61-1300.0	61-1300.0	61-1300.0	3	18	3	0.005

M-MA convertible from Momentary to Maintained action



Switching action: MA = Maintained action, M = Momentary action, M-MA = Momentary action-Maintained action

Mounting dimensions from page 57, Technical drawing from page 58, Circuit drawing from page 64

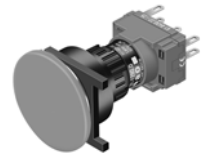
Mushroom-head pushbutton actuator, flush mounting



Essential Accessories:

-  Front bezel set for Mushroom-head pushbutton, flush mounting page 31
-  Mushroom-head cap page 29
-  Switching element for Pushbutton | Keylock- and Selector switch 2 positions page 36

	Front protection	Switching action	∅ 32 mm Typ-Nr.	Mounting dimensions	Technical drawing	Circuit drawing	
Mushroom-head pushbutton actuator, flush mounting	IP 65	MA	61-1200.0	3	22	2	0.005
		M	61-1100.0	3	22	3	0.005
		M-MA	61-1300.0	3	22	3	0.005

M-MA convertible from Momentary to Maintained action



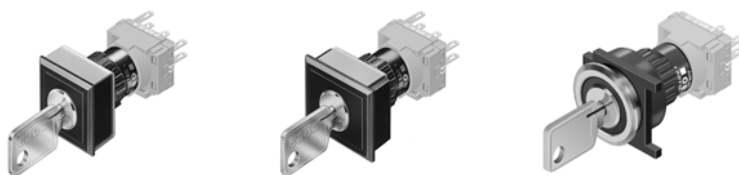

Switching action: MA = Maintained action, M = Momentary action, M-MA = Momentary action-Maintained action

Mounting dimensions from page 57, Technical drawing from page 58, Circuit drawing from page 64

Keylock switch actuator 2 positions, flush mounting



Essential Accessories:

-  Anti-twist ring page 41
-  Front bezel set for Keylock switch, flush mounting page 32
-  Keylock front bezel, flush mounting page 29
-  Switching element for Pushbutton | Keylock- and Selector switch 2 positions page 36

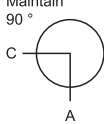
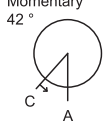
	Front protection	Switching action	Key remove	□ 24 x 24 mm Typ-Nr.	□ 24 x 30 mm Typ-Nr.	∅ 25 mm Typ-Nr.	Mounting dimensions	Technical drawing	Circuit drawing	
Maintain 90° 	IP 65	MA	A	61-2201.0/D	61-2201.0/D	61-2201.0/D	3	20	17	0.065
			C	61-2203.0/D	61-2203.0/D	61-2203.0/D	3	20	17	0.065
			C + A	61-2205.0/D	61-2205.0/D	61-2205.0/D	3	20	17	0.065
Momentary 42° 	IP 65	M	A	61-2101.0/D	61-2101.0/D	61-2101.0/D	3	20	16	0.065

Other lock numbers on request

Switching action: MA = Maintained action, M = Momentary action

Mounting dimensions from page 57, Technical drawing from page 58, Circuit drawing from page 64

Keylock switch actuator 3 positions, flush mounting

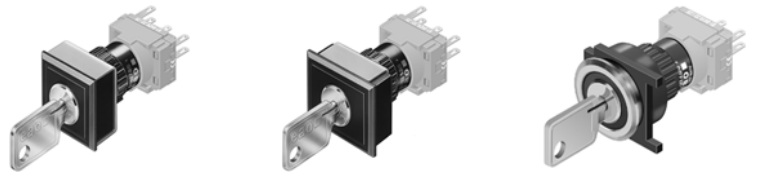

Essential Accessories:

- Anti-twist ring page 41
- Front bezel set for Keylock switch, flush mounting page 32
- Keylock front bezel, flush mounting page 29
- Keylock front bezel, raised mounting page 29
- Switching element for Keylock- and Selector switch 3 positions page 37

	Front protection	Switching action	Key remove	Ø 24 x 24 mm Typ-Nr.	Ø 24 x 30 mm Typ-Nr.	Ø 25 mm Typ-Nr.	Mounting dimensions	Technical drawing	Circuit drawing	
Maintain 90° Momentary 42° 	IP 65	MA-O-MA	A	61-2601.0/D	61-2601.0/D	61-2601.0/D	3	23	19	0.065
			A + B	61-2604.0/D	61-2604.0/D	61-2604.0/D	3	20	19	0.065
			B	61-2602.0/D	61-2602.0/D	61-2602.0/D	3	20	19	0.065
			C	61-2603.0/D	61-2603.0/D	61-2603.0/D	3	20	19	0.065
			C + A	61-2605.0/D	61-2605.0/D	61-2605.0/D	3	20	19	0.065
			C + A + B	61-2607.0/D	61-2607.0/D	61-2607.0/D	3	20	19	0.065
			C + B	61-2606.0/D	61-2606.0/D	61-2606.0/D	3	20	19	0.065
Pos. C: Maintained action Pos. A: Basic position Pos. B: Momentary action Standard lock 311	IP 65	MA-O-M	A	61-2701.0/D	61-2701.0/D	61-2701.0/D	3	20	18	0.065
			C	61-2703.0/D	61-2703.0/D	61-2703.0/D	3	20	18	0.065
			C + A	61-2705.0/D	61-2705.0/D	61-2705.0/D	3	20	18	0.065
Pos. C: Momentary action Pos. A: Basic position Pos. B: Maintained action Standard lock 311	IP 65	M-O-MA	A + B	61-2804.0/D	61-2804.0/D	61-2804.0/D	3	20	15	0.065
			B	61-2802.0/D	61-2802.0/D	61-2802.0/D	3	20	15	0.065
Pos. C: Momentary action Pos. A: Basic position Pos. B: Maintained action Standard lock 311	IP 65	M-O-MA	A	61-2801.0/D	61-2801.0/D	61-2801.0/D	3	20	15	0.065
Pos. C: Momentary action Pos. A: Basic position Pos. B: Momentary action Standard lock 311	IP 65	M-O-M	A	61-2501.0/D	61-2501.0/D	61-2501.0/D	3	20	14	0.065

Other lock numbers on request

Switching action: MA = Maintained action, M = Momentary action





Mounting dimensions from page 57, Technical drawing from page 58, Circuit drawing from page 64

Selector switch actuator 2 positions, flush mounting

illuminative



Essential Accessories:

-  Anti-twist ring page 41
-  Front bezel set for Selector switch, flush mounting page 32
-  Lever, flush mounting page 30
-  Single-LED page 39
-  Switching element for Pushbutton | Keylock- and Selector switch 2 positions page 36

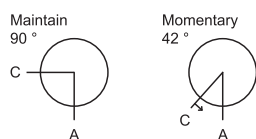

	Front protection	Switching action	24 x 24 mm Typ-Nr.	Ø 25 mm Typ-Nr.	Mounting dimensions	Technical drawing	Circuit drawing	
Selector switch actuator 2 positions, flush mounting Position C: Maintained action Position A: Basic position	IP 65	MA	61-4210.0	61-4210.0	3	21	8	0.006
Position C: Momentary action Position A: Basic position	IP 65	M	61-4110.0	61-4110.0	3	21	7	0.006

Switching action: MA = Maintained action, M = Momentary action







Mounting dimensions from page 57, Technical drawing from page 58, Circuit drawing from page 64

Selector switch actuator 3 positions, flush mounting

illuminative



Essential Accessories:

-  Anti-twist ring page 41
-  Front bezel set for Selector switch, flush mounting page 32
-  Keylock front bezel, flush mounting page 29
-  Lever, flush mounting page 30
-  Single-LED page 39
-  Switching element for Keylock- and Selector switch 3 positions page 37

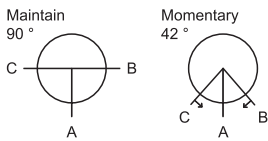

	Front protection	Switching action	\square 24 x 24 mm Typ-Nr.	\varnothing 25 mm Typ-Nr.	Mounting dimensions	Technical drawing	Circuit drawing	
Selector switch actuator 3 positions, flush mounting Position C: Maintained action Position A: Basic position Position B: Maintained action	IP 65	MA-O-MA	61-4610.0	61-4610.0	3	21	12	0.006
Position C: Maintained action Position A: Basic position Position B: Momentary action	IP 65	MA-O-M	61-4710.0	61-4710.0	3	21	11	0.006
Position C: Momentary action Position A: Basic position Position B: Maintained action	IP 65	M-O-MA	61-4810.0	61-4810.0	3	21	10	0.006
Position C: Momentary action Position A: Basic position Position B: Momentary action	IP 65	M-O-M	61-4510.0	61-4510.0	3	21	9	0.006

Switching action: MA = Maintained action, M = Momentary action

Mounting dimensions from page 57, Technical drawing from page 58, Circuit drawing from page 64

Potentiometer, flush mounting



	Front protection	Front bezel	Terminals	□ 24 x 24 mm Typ-Nr.	∅ 25 mm Typ-Nr.	Mounting dimensions	Technical drawing	Circuit drawing	
Potentiometer, flush mounting 10 k Ω (linear), 1 W, mechanical travel 300 °	IP 65	Plastic black	FR	61-4970.13		3	9	1	0.023
					61-4970.10	3	9	1	0.016

Cable length 300 mm

Terminals: FR = Flat ribbon cable

Mounting dimensions from page 57, Technical drawing from page 58, Circuit drawing from page 64

Front

Lens plastic, raised mounting

mat

	Lens	∅ 24 x 24 mm Typ-Nr.	∅ 18 x 18 mm Typ-Nr.	∅ 18 x 24 mm Typ-Nr.	∅ 24 mm Typ-Nr.	∅ 18 mm Typ-Nr.	
Lens plastic, raised mounting flush, illuminative	blue transparent	61-9351.6	61-9321.6	61-9331.6	61-9642.6	61-9311.6	0.002
	colourless transparent	61-9351.7	61-9321.7	61-9331.7	61-9642.7	61-9311.7	0.002
	green transparent	61-9351.5	61-9321.5	61-9331.5	61-9642.5	61-9311.5	0.002
	orange transparent	61-9351.3	61-9321.3	61-9331.3	61-9642.3	61-9311.3	0.002
	red transparent	61-9351.2	61-9321.2	61-9331.2	61-9642.2	61-9311.2	0.002
	smoked transparent	61-9351.1	61-9321.1	61-9331.1	61-9642.1	61-9311.1	0.002
	yellow transparent	61-9351.4	61-9321.4	61-9331.4	61-9642.4	61-9311.4	0.002
flush, non- illuminative	black opaque	61-9251.0	61-9221.0	61-9231.0		61-9211.0	0.002
	grey opaque	61-9251.8	61-9221.8	61-9231.8		61-9211.8	0.002
	white translucent	61-9251.9	61-9221.9	61-9231.9		61-9211.9	0.002
concave, illuminative	blue transparent		61-9326.6	61-9336.6			0.002
	colourless transparent		61-9326.7	61-9336.7			0.002
	green transparent		61-9326.5	61-9336.5			0.002
	orange transparent		61-9326.3	61-9336.3			0.002
	red transparent		61-9326.2	61-9336.2			0.002
	yellow transparent		61-9326.4	61-9336.4			0.002
concave, non- illuminative	black opaque		61-9226.0	61-9236.0			0.002
	grey opaque		61-9226.8	61-9236.8			0.002
	white translucent		61-9226.9	61-9236.9			0.002



Lens plastic, flush mounting

mat

	Lens	∅ 24 x 24 mm Typ-Nr.	∅ 24 x 30 mm Typ-Nr.	∅ 25 mm Typ-Nr.	
Lens plastic, flush mounting illuminative	blue transparent	61-9671.6	61-9681.6	61-9642.6	0.002
	colourless transparent	61-9671.7	61-9681.7	61-9642.7	0.002
	green transparent	61-9671.5	61-9681.5	61-9642.5	0.002
	orange transparent	61-9671.3	61-9681.3	61-9642.3	0.002
	red transparent	61-9671.2	61-9681.2	61-9642.2	0.002
	smoked transparent	61-9671.1	61-9681.1	61-9642.1	0.002
	yellow transparent	61-9671.4	61-9681.4	61-9642.4	0.002
non-illuminative	black opaque	61-9771.0	61-9781.0		0.002
	grey opaque	61-9771.8	61-9781.8		0.002
	white opaque	61-9771.9	61-9781.9		0.002



Marking plate for Lens plastic

can be hot stamped

	Marking plate	Typ-Nr.	
Marking plate for Lens plastic only applicable with Lens round Typ-Nr. 61-9642.X	Plastic colourless transparent	61-9707.7	0.001



Lens metal with window, raised mounting

mat

	Lens	Ø 24 mm Typ-Nr.	
Lens metal with window, raised mounting	Aluminium natural	61-9841.8A	0.002



Lens metal with window, flush mounting

mat

	Lens	Ø 25 mm Typ-Nr.	
Lens metal with window, flush mounting	Aluminium natural	61-9841.8A	0.002



Lens metal, raised mounting

mat

	Lens	Ø 24 mm Typ-Nr.	
Lens metal, raised mounting	Aluminium black	61-9841.0	0.002
	Aluminium blue	61-9841.6	0.002
	Aluminium green	61-9841.5	0.002
	Aluminium natural	61-9841.8	0.002
	Aluminium red	61-9841.2	0.002
	Aluminium yellow	61-9841.4	0.002



Lens metal, flush mounting

mat

	Lens	Ø 25 mm Typ-Nr.	
Lens metal, flush mounting	Aluminium black	61-9841.0	0.002
	Aluminium blue	61-9841.6	0.002
	Aluminium green	61-9841.5	0.002
	Aluminium natural	61-9841.8	0.002
	Aluminium red	61-9841.2	0.002
	Aluminium yellow	61-9841.4	0.002



Mushroom-head cap

	Mushroom had cap	Ø 32 mm Typ-Nr.	
Mushroom-head cap	Plastic black opaque	61-9593.0	0.004
	Plastic green opaque	61-9593.5	0.004
	Plastic red opaque	61-9593.2	0.004
	Plastic yellow opaque	61-9593.4	0.004



Keylock front bezel, raised mounting

	Keylock front bezel	Ø 24 x 24 mm Typ-Nr.	Ø 18 x 18 mm Typ-Nr.	Ø 24 x 18 mm Typ-Nr.	Ø 18 mm Typ-Nr.	
Keylock front bezel, raised mounting	Plastic black	61-9250.0	61-9220.0	61-9230.0	61-9210.0	0.001



Keylock front bezel, flush mounting

	Keylock front bezel	Ø 24 x 24 mm Typ-Nr.	Ø 24 x 30 mm Typ-Nr.	Ø 25 mm Typ-Nr.	
Keylock front bezel, flush mounting	Plastic black	61-9220.0	61-9230.0	61-9210.0	0.001



Lever, raised mounting

with bar and marking dot

	Lever	Bar colour	Typ-Nr.	
Lever, raised mounting illuminative	Plastic black	blue	52-928.60	0.001
		green	52-928.50	0.001
		orange	52-928.30	0.001
		red	52-928.20	0.001
		yellow	52-928.40	0.001
	Plastic grey	blue	52-929.60	0.001
		green	52-929.50	0.001
		orange	52-929.30	0.001
		red	52-929.20	0.001
		yellow	52-929.40	0.001
non-illuminative	Plastic black	black	52-928.0	0.001
		white	52-928.9	0.001
	Plastic grey	grey	52-929.8	0.001
		white	52-929.9	0.001



Lever, flush mounting

	Lever	Bar colour	Typ-Nr.	
Lever, flush mounting illuminative	Plastic black	blue	61-9028.60	0.001
		green	61-9028.50	0.001
		orange	61-9028.30	0.001
		red	61-9028.20	0.001
		yellow	61-9028.40	0.001
	Plastic grey	blue	61-9029.60	0.001
		green	61-9029.50	0.001
		orange	61-9029.30	0.001
		red	61-9029.20	0.001
		yellow	61-9029.40	0.001
non-illuminative	Plastic black	black	61-9028.0	0.001
		white	61-9028.9	0.001
	Plastic grey	grey	61-9029.8	0.001
		white	61-9029.9	0.001



Legend plate

can be marked

	Typ-Nr.	Technical drawing	
Legend plate 30 x 42 mm, adhesive, Aluminium natural, Mounting hole size 22.5 mm dia.	704.962.0	10	0.002
42 x 42 mm, adhesive, Aluminium natural, Mounting hole size 22.5 mm dia.	704.962.5	10	0.003



Technical drawing from page 58

Legend frame

for devices 25 mm dia., flush mounting

	Typ-Nr.	Technical drawing	
Legend frame 30 x 50 mm, adhesive, Aluminium black	61-9980.0	11	0.001



Technical drawing from page 58

Legend plate insert

for Legend frame 61-9980.0

	Typ-Nr.	Technical drawing	
Legend plate insert 14.5 x 23.5 mm, adhesive, Aluminium black	704.968.1	11	0.001
14.5 x 23.5 mm, adhesive, Aluminium natural	704.968.0	11	0.001

Technical drawing from page 58



Front bezel square, raised mounting

	Front bezel	Typ-Nr.	
Front bezel square, raised mounting 24 x 24 mm, for Selector switch	Plastic black	52-950.0	0.001
26 x 26 mm, for Selector switch	Plastic black	52-952.0	0.001



Front bezel set for Indicators and Illuminated pushbutton, flush mounting

	Front bezel	Ø 24 x 24 mm Typ-Nr.	Ø 24 x 30 mm Typ-Nr.	Ø 25 mm Typ-Nr.	Mounting dimensions	
Front bezel set for Indicators and Illuminated pushbutton, flush mounting	Plastic black	61-9930.0	61-9931.0	61-9933.10	3	0.008
	Aluminium black			61-9933.1	3	0.006
	Aluminium natural			61-9933.0	3	0.006

Mounting dimensions from page 57



Front bezel set for Mushroom-head pushbutton, flush mounting

	Front bezel	Ø 32 mm Typ-Nr.	Ø 25 mm Typ-Nr.	Mounting dimensions	
Front bezel set for Mushroom-head pushbutton, flush mounting	Aluminium natural	61-9934.8		3	0.013
	Aluminium black		61-9933.1	3	0.006
	Aluminium natural		61-9933.0	3	0.006
	Plastic black		61-9933.10	3	0.008

Mounting dimensions from page 57



Front bezel set for Keylock switch, flush mounting

	Front bezel	□ 24 x 24 mm Typ-Nr.	□ 24 x 30 mm Typ-Nr.	Ø 25 mm Typ-Nr.	Mounting dimensions	
Front bezel set for Keylock switch, flush mounting	Plastic black	61-9930.0	61-9931.0	61-9932.10	3	0.008
	Aluminium black			61-9932.1	3	0.006
	Aluminium natural			61-9932.0	3	0.006



Mounting dimensions from page 57

Front bezel set for Selector switch, flush mounting

	Front bezel	□ 24 x 24 mm Typ-Nr.	Ø 25 mm Typ-Nr.	Mounting dimensions	
Front bezel set for Selector switch, flush mounting	Plastic black	61-9936.0		3	0.007
	Aluminium black		61-9932.1	3	0.006
	Aluminium natural		61-9932.0	3	0.006
	Plastic black		61-9932.10	3	0.008



Mounting dimensions from page 57

Front ring, raised mounting

	Front ring	Typ-Nr.	
Front ring, raised mounting for Actuator 24 mm dia.	Aluminium black	61-9600.0	0.003
	Aluminium natural	61-9600.1	0.003



Front protective cap

	Front protective cap	Typ-Nr.	
Front protective cap for front bezel set 24 x 30 mm, flush mounting	Silicone natural transparent	61-9927.2	0.001
	Silicone natural transparent	84-9103.7	0.001



ATTENTION

when using the front protection cover for push buttons the external sealing in the front bezel set and the silicone bellows in the actuator are to be removed !

Protective cover, raised mounting

	∅ 24 x 24 mm Typ-Nr.	∅ 18 x 18 mm Typ-Nr.	∅ 18 x 24 mm Typ-Nr.	Technical drawing	
Protective cover, raised mounting hinged, transparent, with means not for sealing	61-9920.0			5	0.004
hinged, transparent, with means for sealing		51-920		1	0.002
			51-925	2	0.002



Technical drawing from page 58

Protective cover, flush mounting

	∅ 24 x 24 mm Typ-Nr.	∅ 30 x 24 mm Typ-Nr.	∅ 25 mm Typ-Nr.	Mounting dimensions	Technical drawing
Protective cover, flush mounting hinged, transparent, with means for sealing	61-9921.0			3 6	0.006
slide by side, with means not for sealing		61-9922.0		3 7	0.006
			61-9924.0	3 8	0.006



Mounting dimensions from page 57, Technical drawing from page 58

Blind plug, raised mounting

	Blind plug	∅ 24 x 24 mm Typ-Nr.	∅ 18 x 18 mm Typ-Nr.	∅ 18 x 24 mm Typ-Nr.	∅ 18 mm Typ-Nr.	Mounting dimensions
Blind plug, raised mounting	Plastic black	61-9450.0	51-948.0	51-947.0	51-949.0	1 0.003



Mounting dimensions from page 57

Blind plug, flush mounting

	Blind plug	∅ 24 x 24 mm Typ-Nr.	∅ 24 x 30 mm Typ-Nr.	∅ 28 mm Typ-Nr.	Mounting dimensions
Blind plug, flush mounting	Plastic black	61-9451.0	61-9452.0	61-9453.0	3 0.006



Mounting dimensions from page 57

Master key

	Typ-Nr.	
Master key Lock numbers 311 ... 445 (DOM)	31-989.300	0.006



Spare key

	Typ-Nr.	
Spare key Emergency-stop, standard lock 1001 (KABA)	14-987.1001	0.006
Key lock switch, standard lock 311 (DOM)	31-989.311	0.006



Other lock numbers on request

EMC Key protection cap

	Typ-Nr.	
EMC Key protection cap Plastic black, for lock type DOM	31-985.0	0.005



Backside

Lamp element

	Terminals	Typ-Nr.	Component layout		
			Component layout	Circuit drawing	
Lamp element	ST	61-8006.01	31	4	0.005
	S1	61-8006.02	3	4	0.005



Terminals: ST = Screw terminal, S1 = Soldering terminal (also pluggable 2.8 x 0.5 mm)
Component layout from page 52, Circuit drawing from page 64

Diode element

	Terminals	Typ-Nr.	Component layout		
			Component layout	Circuit drawing	
Diode element	S1	61-8101.02	1	20	0.007
1 Diode					
2 Diodes	S1	61-8102.02	2	21	0.008



Terminals: S1 = Soldering terminal (also pluggable 2.8 x 0.5 mm)
 Component layout from page 52, Circuit drawing from page 64

Flasher element

	Terminals	Typ-Nr.	Component layout		
			Component layout	Circuit drawing	
Flasher element	S	61-8000.05	30		0.005
Operation voltage : 12 ... 28 VAC/DC ± 10 %					



Further information in the Technical data and Typical applications
 Terminals: S = Soldering terminal
 Component layout from page 52

Switching element for Pushbutton | Keylock- and Selector switch 2 positions

	Diode (1N 4007)	Switch rating	Switching system	Contacts	Terminals	Contact material	Typ-Nr.	Component layout		Circuit drawing	kg	
Switching element for Pushbutton Keylock- and Selector switch 2 positions with lamp terminal	2 D	250 VAC, 5 A	SA	1 NO	S1	Au / Ag	61-8212.22	36	28	0.007		
						Ag	61-8212.12	36	28	0.007		
	-	250 VAC, 5 A	SM	1 NC	ST	Ag	61-8640.11	23	22	0.008		
					1 NC + 1 NO	S1	Ag	61-8670.17	14	23	0.008	
					1 NO	ST	Ag	61-8610.11	22	27	0.008	
						S1	Ag	61-8610.17	11	27	0.008	
					2 NC	S1	Ag	61-8650.17	15	24	0.008	
					2 NO	S1	Ag	61-8620.17	12	34	0.008	
				SA	1 NC	S1	Au / Ag	61-8440.22	4	23	0.007	
								Ag	61-8440.12	4	23	0.007
						1 NC + 1 NO	S1	Au / Ag	61-8470.22	34	30	0.007
								Ag	61-8470.12	34	30	0.007
						1 NC + 2 NO	S1	Au / Ag	61-8490.22	35	32	0.007
								Ag	61-8490.12	35	32	0.007
					1 NO	S1	Au / Ag	61-8410.22	28	27	0.007	
							Ag	61-8410.12	28	27	0.007	
					2 NC	S1	Au / Ag	61-8450.22	5	24	0.007	
							Ag	61-8450.12	5	24	0.007	
					2 NC + 1 NO	S1	Au / Ag	61-8480.22	7	31	0.007	
							Ag	61-8480.12	7	31	0.007	
				2 NO	S1	Au / Ag	61-8420.22	32	34	0.007		
						Ag	61-8420.12	32	34	0.007		
				3 NC	S1	Au / Ag	61-8460.22	6	25	0.007		
						Ag	61-8460.12	6	25	0.007		
				3 NO	S1	Au / Ag	61-8430.22	33	35	0.007		
						Ag	61-8430.12	33	35	0.007		
			42 VAC, 100 mA	SM	1 NC	S1	Au	61-8640.37	14	23	0.008	
						1 NC + 1 NO	S1	Au	61-8670.37	13	30	0.008
					1 NO	S1	Au	61-8610.37	11	27	0.008	
					2 NC	S1	Au	61-8650.37	15	24	0.008	
					2 NO	S1	Au	61-8620.37	12	34	0.008	
without lamp terminal	-	250 VAC, 5 A	SM	1 NC	ST	Ag	61-8645.11	25	22	0.008		
				1 NC + 1 NO	ST	Ag	61-8675.11	26	29	0.008		
				1 NO	ST	Ag	61-8615.11	24	26	0.008		
				2 NC	ST	Ag	61-8655.11	29	36	0.008		
				2 NO	ST	Ag	61-8625.11	27	33	0.008		

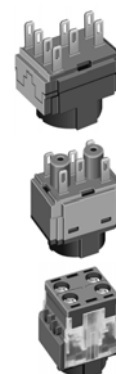

We offer a Dismantling tool Typ-Nr. 61-9711.0 for dismantling of the Switching element

Diode (1N 4007): D = Diode, - = without

Switching system: SA = Snap-action switching element, SM = Slow-make switching element

Contacts: NO = Normally open, NC = Normally closed

Terminals: S1 = Soldering terminal (also pluggable 2.8 x 0.5 mm), ST = Screw terminal

Contact material: Au = Gold, Ag = Silver

Component layout from page 52, Circuit drawing from page 64

Switching element for Keylock- and Selector switch 3 positions

	Switch rating	Switching system	Contacts	Terminals	Contact material	Typ-Nr.	Component layout	Circuit drawing		
Switching element for Keylock- and Selector switch 3 positions with lamp terminal	250 VAC, 5 A	SM	1 NC + 1 NO	S1	Ag	61-8770.17	16	30	0.008	
			2 NC	S1	Ag	61-8750.17	18	24	0.008	
			2 NO	S1	Ag	61-8720.17	17	34	0.008	
		SA	1 NC + 1 NO	S1		Au / Ag	61-8574.22	10	30	0.008
						Ag	61-8574.12	10	30	0.008
			2 NC	S1		Au / Ag	61-8550.22	8	24	0.008
						Ag	61-8550.12	8	24	0.008
			2 NO	S1		Au / Ag	61-8520.22	9	34	0.008
						Ag	61-8520.12	9	34	0.008
42 VAC, 100 mA	SM	1 NC + 1 NO	S1	Au	61-8770.37	16	30	0.008		
		2 NO	S1	Au	61-8720.37	9	34	0.008		
without lamp terminal	250 VAC, 5 A	SM	1 NC + 1 NO	ST	Ag	61-8775.11	26	37	0.008	
			2 NC	ST	Ag	61-8755.11	29	36	0.008	
			2 NO	ST	Ag	61-8725.11	27	33	0.008	

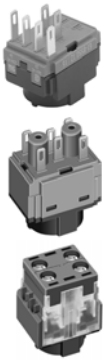

We offer a Dismantling tool Typ-Nr. 61-9711.0 for dismantling of the Switching element
 Switching system: SM = Slow-make switching element, SA = Snap-action switching element
 Contacts: NC = Normally closed, NO = Normally open
 Terminals: S1 = Soldering terminal (also pluggable 2.8 x 0.5 mm), ST = Screw terminal
 Contact material: Ag = Silver, Au = Gold
 Component layout from page 52, Circuit drawing from page 64

Switching element for Emergency-stop pushbutton

	Switch rating	Switching system	Contacts	Terminals	Contact material	Typ-Nr.	Component layout	Circuit drawing		
Switching element for Emergency-stop pushbutton	250 VAC, 5 A	SM	1 NC	ST	Ag	61-8745.11	25	38	0.008	
				S1	Ag	61-8745.17	20	38	0.008	
			1 NC + 1 NO	ST	Ag	61-8775.11	26	37	0.008	
				S1	Ag	61-8775.17	19	37	0.008	
			2 NC	ST	Ag	61-8755.11	29	36	0.008	
				S1	Ag	61-8755.17	21	36	0.008	
		42 VAC, 100 mA	SM	1 NC	S1	Au	61-8745.37	20	38	0.008
				1 NC + 1 NO	S1	Au	61-8775.37	19	37	0.008
				2 NC	S1	Au	61-8755.37	21	36	0.008



General specifications for Switching element for Emergency-stop pushbutton : If not otherwise stated, certified according to EN IEC 60947-5-5. Further specifications in the Technical data
 Switching system: SM = Slow-make switching element
 Contacts: NC = Normally closed, NO = Normally open
 Terminals: ST = Screw terminal, S1 = Soldering terminal (also pluggable 2.8 x 0.5 mm)
 Contact material: Ag = Silver, Au = Gold
 Component layout from page 52, Circuit drawing from page 64

PCB plug-in base

	Terminals	Typ-Nr.	Component layout	
PCB plug-in base 15 x 23 x 9.4 mm for Snap-action Switching element, Indicator- and Diode element, Pins axial	P	61-9823	39	0.002
17.7 x 23.6 x 10.9 mm for Slow-make Switching element, Pins axial	P	61-9821.1	38	0.003
13.1 x 12.8 mm for Indicator complete	P	61-9820.1	37	0.003



Terminals: P = PCB terminal
Component layout from page 52

Multi-plug housing

	Typ-Nr.	
Multi-plug housing for Snap-action Switching element, max. 6 connections possible	61-9830	0.002



Flat receptacle

	Typ-Nr.	
Flat receptacle 2.8 x 0.5 mm for multi-plug housing	51-943.1	0.001
2.8 x 0.5 mm for Plug-in terminal	31-946	0.001



Insulation sleeve

	Typ-Nr.	
Insulation sleeve for Flat receptacles 31-946	31-929	0.001



Terminal cover

	Typ-Nr.	
Terminal cover for Indicator complete	61-9831.2	0.001
for Snap-action Switching element with soldering terminal	61-9830.2	0.002



Illumination

Filament lamp

	Socket	Operating voltage/-current	Typ-Nr.	
Filament lamp	T1 3/4 MG	12 VAC/DC, 75 mA	10-1309.1309	0.001
		14 VAC/DC, 80 mA	10-1310.1319	0.001
		18 VAC/DC, 40 mA	10-1311.1249	0.001
		24 VAC/DC, 35 mA	10-1312.1229	0.001
		28 VAC/DC, 30 mA	10-1313.1209	0.001
		28 VAC/DC, 40 mA	10-1313.1249	0.001
		36 VAC/DC, 20 mA	10-1316.1179	0.001
		36 VAC/DC, 30 mA	10-1316.1209	0.001
		48 VAC/DC, 20 mA	10-1319.1179	0.001
		48 VAC/DC, 25 mA	10-1319.1199	0.001
		6 VAC/DC, 125 mA	10-1306.1349	0.001
		6.3 VAC/DC, 200 mA	10-1307.1369	0.001



Single-LED

	Socket	Operating voltage/-current	Colour	Typ-Nr.	
Single-LED	T1 3/4 MG	12 VAC/DC, 7/14 mA	blue	10-2J09.1066	0.002
			green	10-2J09.1065	0.002
			red	10-2J09.1062	0.002
			white diffuse	10-2J09.1069	0.002
			yellow	10-2J09.1064	0.002
		24 VAC/DC, 7/14 mA	blue	10-2J12.1066	0.002
			green	10-2J12.1065	0.002
			red	10-2J12.1062	0.002
			white diffuse	10-2J12.1069	0.002
			yellow	10-2J12.1064	0.002
		28 VAC/DC, 7/14 mA	blue	10-2J13.1066	0.002
			green	10-2J13.1065	0.002
			red	10-2J13.1062	0.002
			white diffuse	10-2J13.1069	0.002
			yellow	10-2J13.1064	0.002
		48 VAC/DC, 4/8 mA	blue	10-2J19.1046	0.002
			green	10-2J19.1045	0.002
			red	10-2J19.1042	0.002
			white diffuse	10-2J19.1049	0.002
			yellow	10-2J19.1044	0.002
6 VDC, 15 mA	blue	10-2J06.3146	0.002		
	green	10-2J06.3145	0.002		
	red	10-2J06.3142	0.002		
	white diffuse	10-2J06.3149	0.002		
	yellow	10-2J06.3144	0.002		



Terminal plate empty

for fitting with series resistors and capacitors

	Typ-Nr.	
Terminal plate empty 10 spaces 125 x 60 x 15 mm	02-912.2	0.045
15 spaces 187.5 x 60 x 15 mm	02-912.3	0.090
20 spaces 250 x 60 x 15 mm	02-912.4	0.095
5 spaces 62.5 x 60 x 15 mm	02-912.1	0.025



Emergency-stop pushbutton

Emergency-stop label

Mounting hole size 16 mm dia.

	Marking	Typ-Nr.	
Emergency-stop label 43 mm dia., yellow	ARRET-D'URGENCE	61-9970.3	0.002
	EMERGENCY-STOP	61-9970.2	0.002
	NOT-AUS	61-9970.1	0.002
	without marking	61-9970.0	0.002



Emergency-stop protective shroud

	Typ-Nr.	
Emergency-stop protective shroud Aluminium anodized, yellow varnished	61-9965	0.036



Emergency-stop enclosures

	Typ-Nr.	
Emergency-stop enclosures with mounting hole size 16 mm dia., without anti-twist device	61-9480.5	0.099

Bottom grey similar RAL 7035; cover lead-sealable, yellow similar RAL 1004
4 openings for cable gland M16 or M20
Protection class IP 66
Dimension: 65 mm long, 65 mm wide, 57 mm high



Cable gland

	Typ-Nr.	
Cable gland M16, Plastic grey	61-9481.6	0.007
M20, Plastic grey	704.945.6	0.011



with traction relief; protection degree IP 68

Assembling

Fixing nut

	Typ-Nr.	 kg
Fixing nut Metal, specifically for keylock switches	31-991	0.005
Plastic, standard delivery	61-9915.0	0.002



Anti-twist ring

	Typ-Nr.	 kg
Anti-twist ring Mounting hole size 16 mm dia.	51-910	0.001
Mounting hole size 22.5 mm dia.	61-9912.0	0.002



Reducing ring

without Keylock- and Selector switch

	Typ-Nr.	 kg
Reducing ring only for use of devices with Front size 24 x 24 mm and 24 mm dia., Mounting hole size 22.5 mm dia.	61-9960	0.003



Tool set

consists of Lens remover, Lamp-and LED remover, Mounting tool, Dismantling tool

	Typ-Nr.	 kg
Tool set	K61-999.100	0.048

for dismantling keep care of the enclosed Packing insert

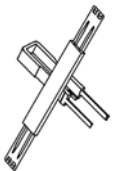

Lens remover

	Typ-Nr.	 kg
Lens remover for raised mounting	02-905	0.011
for flush mounting	61-9730.0	0.011



Lamp remover

	Typ-Nr.	 kg
Lamp remover	61-9740.0	0.003



CAUTION

A switching process might be released when replacing the lamp/LED !

Mounting tool

	Typ-Nr.	 kg
Mounting tool for tightening or loosening of the Fixing nut	01-907	0.020



Dismantling tool

	Typ-Nr.	 kg
Dismantling tool for dismantling of the Switching element	61-9711.0	0.004

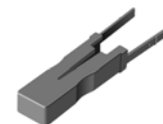

Flat receptacle remover

	Typ-Nr.	 kg
Flat receptacle remover for removing the Flat receptacle of the Multi-plug in housing	51-943.9	0.001



Enclosure

	Typ-Nr.	 kg
Enclosure with mounting hole size 16 mm dia., without anti- twist device	61-9480.6	0.099

Grey similar RAL 7035; cover lead-sealable
4 openings for cable gland M16 or M20
Protection class IP 66
Dimension: 65 mm long, 65 mm wide, 57 mm high



Cable gland

	Typ-Nr.	 kg
Cable gland M16, Plastic grey	61-9481.6	0.007
M20, Plastic grey	704.945.6	0.011



with traction relief; protection degree IP 68

Actuator with snap-action switching element

Switching system

Self-cleaning, double-break snap-action switching system with contact opening width 2 x 0.5 mm (switch with small contact opening width as per EN IEC 61058-1).

The switching elements are optionally equipped with the following switching functions :

One to three normally open (NO) or normally closed (NC), or any combination of NO and NC plus connections for T1 $\frac{3}{4}$ LED or lamp. The number of switching elements cannot exceed three.

The switching elements provided for the 3-position switch actuators are equipped with max. 2 NC or 2 NO or any combination. The number of switching elements cannot exceed two.

Material

Lens

Raised mounting Polymethylmethacrylat (PMMA), as per UL 94 HB, flush mounting Polycarbonat (PC), as per UL 94 V0, or Aluminium anodized

Front bezel

Polyetherimid (PEI), as per UL 94 V0, or Aluminium anodized

Front ring

Aluminium anodized

Material of contact

Silver or silver with gold plating

Switching element

Diallylphthalate (DAP), as per UL 94 V0 and Polyamide (PA 66), as per UL 94 V0

Actuator housing

Polyetherimide (PEI), as per UL 94 V0, self-extinguishing

Mechanical characteristics

Terminals

	rigid	flexible	superflexible
1 wire :	0.5 ... 1.5 mm ²	0.5 ... 0.75 mm ²	0.5 mm ²
2 wires :	0.75 mm ²	0.5 mm ²	

Actuating torque

Selector-/ Keylock switch : 2.5 ... 10 Ncm

Actuating force

Pushbutton : 2.7 ... 3.6 N

Actuating travel

Pushbutton : 3 mm

	2 positions	3 positions
Selector-/ keylock switch		
Momentary action :	approx. 42 °	approx. 2 x 42 °
Maintained action :	approx. 90 °	approx. 2 x 90 °

Rebound time

The rebound times apply to normal manual activation

Contact making : 3 ms
Contact breaking : 5 ms

Mechanical lifetime

as per DIN IEC 60512-5-6 and EN IEC 60947-5-1

Pushbutton maintained action :	1 million	cycles of operation
Pushbutton momentary action :	2 million	cycles of operation
Keylock switch :	50.000	cycles of operation
Selector switch :	100.000	cycles of operation

Electrical characteristics

Standards

The devices comply with : EN IEC 61058-1 and EN IEC 60947-5-1

Rated operational voltage

$U_e = 250$ VAC, as per EN IEC 60947-1

Rated insulation voltage

$U_i = 320$ VAC, as per EN IEC 60947-5-1

Rated impulse withstand voltage

$U_{imp} = 4$ kV, as per EN IEC 60947-1

Contact resistance

New state with silver contact : ≤ 100 m Ω
as per DIN IEC 60512-2-4, measured at 100 mA, 10 V

New state with gold plated contact : ≤ 50 m Ω
as per DIN IEC 60512-2-3, measured at 20 mV, 10 mA

Electrical life

≥ 50.000 cycles of operation at 250 VAC, 5 A, $\cos \phi 0.95$
as per EN IEC 60947-5-1

Electrostatic discharge

Keylock switch : 11 kV

Conventional free air thermal current

$I_{th} = 5$ A, as per EN IEC 60947-5-1
the maximum current in continuous operation and at ambient temperature must not exceed the quoted maximum values.

Switch rating

Switch rating AC with silver contact or silver contact with gold plating, service category AC-15, as per EN IEC 60947-5-1

Voltage :	125 VAC	250 VAC
Current :	2.5 A	2 A

Switch rating DC for silver contact or silver contact with gold plating, service category DC-13, as per EN IEC 60947-5-1

Voltage : 250 VDC
Current : 0.15 A

Recommended minimum operational data

Material of contact	Silver	Silver with gold plating
Voltage :	20 VAC/DC	5 VAC/DC
Current :	100 mA	10 mA

Electric strength

2500 VAC, 50 Hz, 1 min., as per DIN IEC 60512-2-11
between all terminals and earth

Overvoltage category

III, as per EN IEC 60947-5-1

Protection class

Class II, as per EN IEC 61058-1

Degree of pollution

3, as per EN IEC 60947-1

Environmental conditions

Storage temperature

-40 °C ... +85 °C

Operating temperature

-25 °C ... +55 °C

Protection degree

as per EN IEC 60529

Frontside IP 65 | backside IP 40

Shock resistance

(semi-sinusoidal)

max. 100 m/s², pulse width 11 ms, 3-axis, as per EN IEC 60068-2-27

Vibration resistance

(sinusoidal)

max. 100 m/s² at 10 Hz ... 500 Hz, as per EN IEC 60068-2-6

Climate resistance

Damp heat, cyclic :

96 hours, +25 °C / 97 %, +55 °C / 93 % relative humidity, as per EN IEC 60068-2-30

Damp heat, state :

56 days, +40 °C / 93 % relative humidity, as per EN IEC 60068-2-78

Rapid change of temperature :

100 cycles, -40 °C ... +80 °C, as per EN IEC 60068-2-14

Approvals

CE (Declaration of conformity)

CB (IEC 60947)

CB (IEC 61058)

CCA-NTR (EN 60947)

CSA

ENEC (EN 61058)

GOST

UL

VDE

German Lloyd

RoHS compliant

Actuator with slow-make switching element

Switching system

Double-break slow-make system, contact opening width 2 x 1.5 mm, with 2 x 2 contact points per switching element.

NC-contact elements in the slow-make elements fulfill requirements of switches with forced opening as per EN IEC 60947-5-1 2.17.

The slow-make elements are optionally obtainable with the following switching functions : 1 NO or 2 NO, 1 NC or 2 NC, 1 NO + 1 NC.

Material

Lens

Raised mounting Polymethylmethacrylat (PMMA), as per UL 94 HB, flush mounting Polycarbonat (PC), as per UL 94 V0, or Aluminium anodized

Front bezel

Polyetherimid (PEI), as per UL 94 V0, or Aluminium anodized

Front ring

Aluminium anodized

Material of contact

Silver or gold (specified for operation for low level switching)

Switching element

Diallylphthalate (DAP), as per UL 94 V0 and Polyamide (PA 66), as per UL 94 V0

Actuator housing

Polyetherimide (PEI), as per UL 94 V0, self-extinguishing

Mechanical characteristics

Terminals

- Solder rigid flexible superflexible

1 wire : 0.5 ... 1.5 mm² 0.5 ... 0.75 mm² 0.5 mm²

2 wires : 0.75 mm² 0.5 mm²

- Screw

1 wire : 0.5 ... 1.5 mm² 0.5 ... 0.75 mm² 0.5 mm²

2 wires : 0.75 mm² 0.5 mm² 0.5 mm²

Actuating torque

Selector-/ Keylock switch : 4 ... 16 Ncm

Actuating force

Pushbutton : 3.5 ... 11 N

Emergency-stop switch : max. 65 N

Actuating travel

Pushbutton : 3 mm

Emergency-stop switch : 10 mm

Selector-/ keylock switch 2 positions 3 positions

Momentary action : approx. 42 ° approx. 2 x 42 °

Maintained action : approx. 90 ° approx. 2 x 90 °

Rebound time

The rebound times apply to normal manual activation

Contact making and contact breaking 2 ms

Mechanical lifetime

as per DIN IEC 60512-5-6 and EN IEC 60947-5-1

Pushbutton maintained action : 1 million cycles of operation

Pushbutton momentary action : 2 million cycles of operation

Keylock switch : 50.000 cycles of operation

Selector switch : 100.000 cycles of operation

Electrical characteristics

Standards

The devices comply with : EN IEC 61058-1 and EN IEC 60947-5-1, EN IEC 60947-5-5 (Emergency-stop)

Electrical life

≥50.000 cycles of operation at 250 VAC, 5 A, cos φ 0.95

as per EN IEC 60947-5-1

Switching element of Emergency-stop 6050 cycles of operation, as per EN IEC 60947-5-5

Electrostatic discharge

Keylock switch : 11 kV

Electric strength

4000 VAC, 50 Hz, 1 min., as per DIN IEC 60512-2 between all terminals and earth

Overvoltage category

III, as per EN IEC 60947-5-1

Protection class

Class II, as per EN IEC 61058-1

Degree of pollution

3, as per EN IEC 60947-1

Electrical characteristics for silver contacts

Rated operational voltage

$U_e = 250 \text{ VAC}$, as per EN IEC 60947-1

Rated insulation voltage

$U_i = 320 \text{ VAC}$, as per EN IEC 60947-5-1

Rated impulse withstand voltage

$U_{imp} = 4 \text{ kV}$, as per EN IEC 60947-1

Contact resistance

New state : $\leq 50 \text{ m}\Omega$

as per DIN IEC 60512-2-4, measured at 100 mA, 10 V

Conventional free air thermal current

$I_{th} = 5 \text{ A}$, as per EN IEC 60947-5-1

the maximum current in continuous operation and at ambient temperature must not exceed the quoted maximum values.

Switch rating

Switch rating AC with silver contact, service category AC-15, as per EN IEC 60947-5-1

125 VAC, 2.5 A | 250 VAC, 2 A

Switch rating with silver contact, service category DC-13, as per EN IEC 60947-5-1

250 VDC, 0.15 A

Switch rating AC with silver contact and screw terminal, service category AC-15, as per EN IEC 60947-5-1

Voltage : 125 VAC 250 VAC

Current : 3 A 2 A

Switch rating with silver contact and screw terminal, service category DC-13, as per EN IEC 60947-5-1

Voltage : 250 VDC

Current : 0.2 A

Recommended minimum operational data

20 VAC/DC, 100 mA

Electrical characteristics for gold contacts

Rated operational voltage

$U_e = 50 \text{ VAC/DC}$, as per EN IEC 60947-5-1

Rated insulation voltage

$U_i = 320 \text{ VAC}$, as per EN IEC 60947-5-1

Rated impulse withstand voltage

$U_{imp} = 0.8 \text{ kV}$, as per EN IEC 60947-1

Contact resistance

New state : $\leq 50 \text{ m}\Omega$

as per DIN IEC 60512-2-4, measured at 20 mA, 10 mV

Conventional free air thermal current

$I_{th} = 3 \text{ A}$, as per EN IEC 60947-5-1

the maximum current in continuous operation and at ambient temperature must not exceed the quoted maximum values.

Switch rating

Switch rating AC with gold contact, service category AC-15, as per EN IEC 60947-5-1

Voltage : 50 VAC

Current : 0.5 A

Switch rating with gold contact, service category DC-13, as per EN IEC 60947-5-1

Voltage : 50 VDC

Current : 0.1 A

Recommended minimum operational data

Voltage : 10 mVAC/DC

Current : 2 mA

Recommended operational data

Voltage : 5 VDC 12 VDC 24 V DC

Current : 10 ... 20 mA 5 ... 10 mA 3 ... 5 mA

Environmental conditions

Storage temperature

-40 °C ... +85 °C

Operating temperature

-25 °C ... +55 °C

Protection degree

as per EN IEC 60529

Frontside IP 65 | backside IP 40

Shock resistance

(semi-sinusoidal)

max. 100 m/s², pulse width 11 ms, 3-axis, as per EN IEC 60068-2-27

Vibration resistance

(sinusoidal)

max. 100 m/s² at 10 Hz ... 500 Hz, as per EN IEC 60068-2-6

Climate resistance

Damp heat, cyclic :

96 hours, +25 °C / 97 %, +55 °C / 93 % relative humidity, as per EN IEC 60068-2-30

Damp heat, state :

56 days, +40 °C / 93 % relative humidity, as per EN IEC 60068-2-78

Rapid change of temperature :

100 cycles, -40 °C ... +80 °C, as per EN IEC 60068-2-14

Approvals

CE (Declaration of conformity)

CB (IEC 60947)

CB (IEC 61058)

CCA-NTR (EN 60947)

ENEC (EN 61058)

GOST

SEV

UL

VDE

German Lloyd

RoHS compliant

Actuator with flasher element

Material

Lens

Raised mounting Polymethylmethacrylat PMMA, as per UL 94 HB,
flush mounting Polycarbonat (PC), as per UL 94 V0

Actuator housing

Polyetherimide (PEI), as per UL 94 V0, self-extinguishing

Flasher element

Polyetherimide (PEI), as per UL 94 V0

Mechanical characteristics

Terminals

Soldering terminal

Electrical characteristics

Illumination

Filament lamp	14 V AC/DC	28 VAC/DC
---------------	------------	-----------

Power consumption :	80 mA	44 mA
---------------------	-------	-------

Single-LED	12 VAC/DC	28 VAC/DC
------------	-----------	-----------

Power consumption :	15 mA	18 mA
---------------------	-------	-------

Flashing frequency

1 Hz \pm 0.25 Hz

Pulse duty factor

approx. 50 %

Operating voltage

12 ... 28 VAC/DC \pm 10 %

Environmental conditions

Operating temperature

0 °C ... +45 °C

Protection degree

as per EN IEC 60529

Frontside IP 65 | backside IP 40

Diode element

When indicators and illuminated pushbuttons equipped with diodes, the user is able to perform a lamp check or wire an alarm circuit simply with a considerable saving of space.

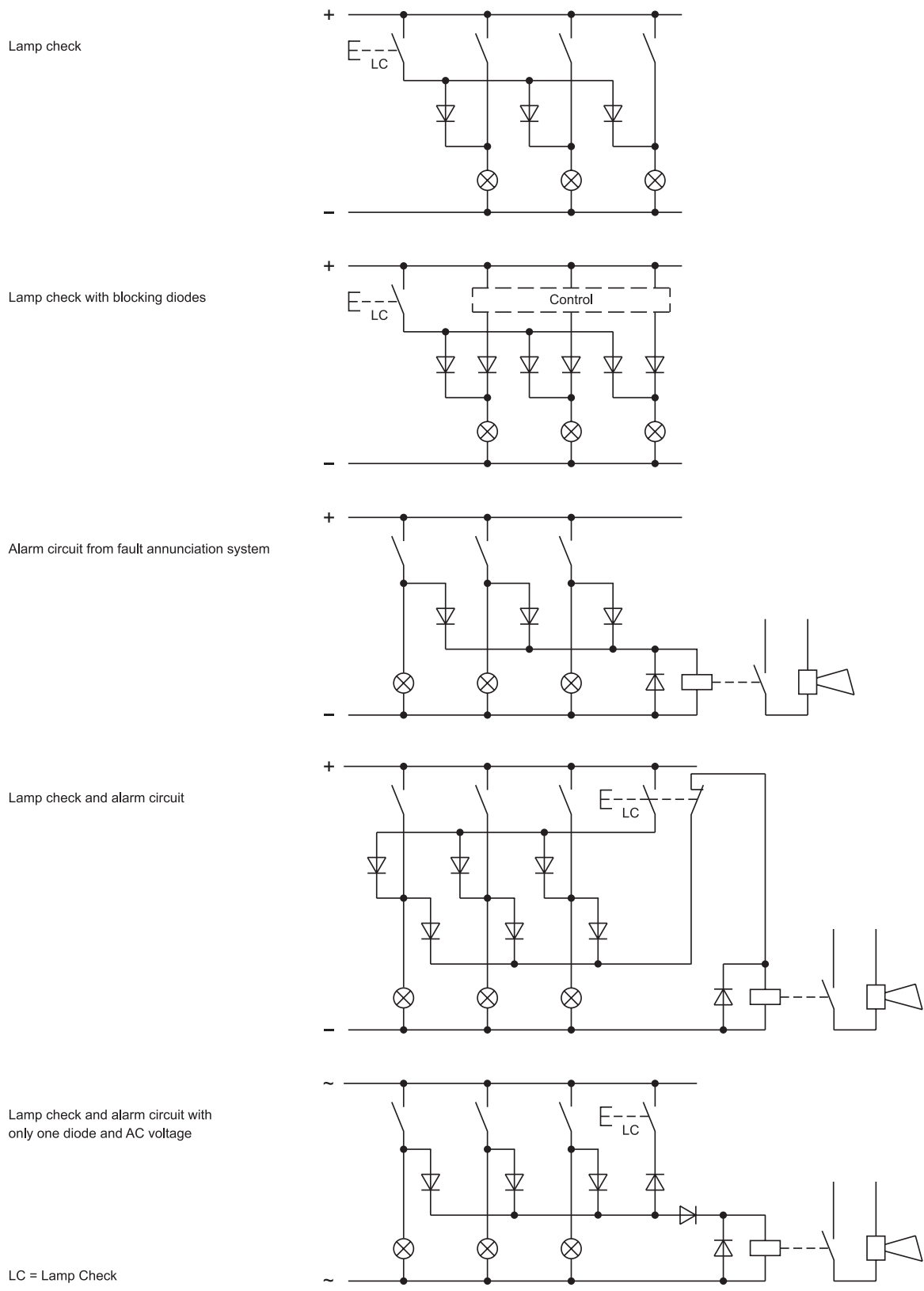

Flasher element

Do not connect terminal B and D simultaneously when powered up. When operating with DC voltage terminal G must have positive polarity.

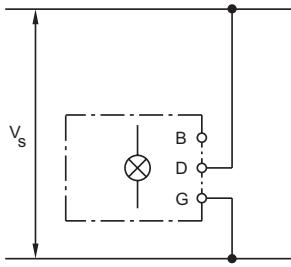

Continuous light

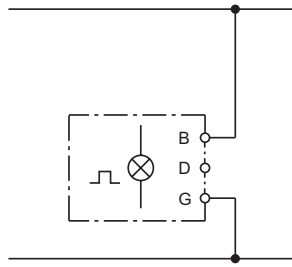

Flashing light

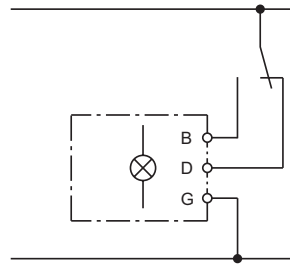

Flashing- or continuous light

General notes

Typefaces

In addition to the most commonly used world languages, in DIN 1451-3 close spacing, other typefaces are available as Scandinavian, Slavic, Greek, Russian and Polish.

Symbols

For larger series it is worth considering markings by means of hot stamping or laser engraving. We will be pleased to advise you.

Color filling of engraving or hot stamping

Red, blue and black lenses are filled with white colour. Other colour lenses are filled in black.

Film inserts

Instead of using engraving the lenses can be fitted with transparent film inserts, as an alternative.

In the case of use of a smoke-black lens the fitted film becomes readable only if the lamp is on.

The film thickness is 0.2 mm.

For lenses 24 mm and 25 mm dia. with Typ-Nr. 619642.x the marking takes place directly on the text plate, Typ-Nr. 61-9707.7, instead of a film insert.

Mounting

Important : Consider pushbutton mounting orientation before specifying engraving characters !

Lenses for Indicators | Illuminated pushbuttons, flush mounting

All dimensions in mm

Front size	Film insert max. size	Height of letters h	Number of lines	Number of (target value) capital letters per line	Number of (target value) small letters per line	Image
24 x 24	15.1 x 15.1	2.5	4	8 - 9	9	B3
		3.0	3	7 - 8	8	B3
		4.0	2	4 - 5	5	B3
		5.0	2	4	4 - 5	B3
		6.0	1	4	4	B3
24 x 30	15.1 x 21	2.5	4	12	13	B1
		3.0	5	8 - 9	9	B2
			4	7 - 8	8	B2
		4.0	2	7	8	B1
			3	4 - 5	5	B2
		5.0	2	5 - 6	6	B1
				4	4 - 5	B2
		6.0	1	4 - 5	5	B1
				2	3	3 - 4
		8.0	1	3 - 4	3 - 4	B1
2 - 3	2 - 3			B2		
25 dia.	Marking plate	2.5	3	6	6	B4
		3.0	2	5	6	B4
		4.0	2	3	4	B4
		5.0	1	2	3	B4
		6.0	1	2	3	B4
		8.0	1	2	2	B4

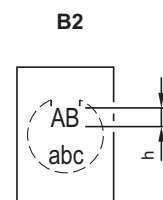
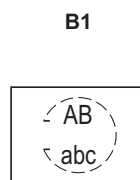
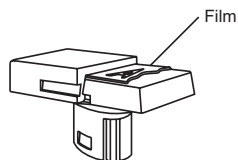
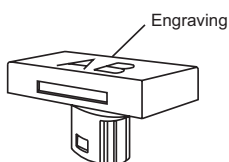

Lenses for Indicators | Illuminated pushbuttons, raised mounting

All dimensions in mm

Front size	Film insert max. size	Height of letters h	Number of lines	Number of (target value) capital letters per line	Number of (target value) small letters per line	Image
18 dia.	12.8 dia.	2.5		6	6	B4
		3.0	2	5	6	B4
		4.0	2	3	4	B4
		5.0	1	2	3	B4
		6.0	1	2	3	B4
		8.0	1	2	2	B4
18 x 18	12.7 x 12.7	2.5	4	7 - 8	8	B3
		3.0	3	6 - 7	7	B3
		4.0	2	4 - 5	5	B3
		5.0	2	3 - 4	4	B3
		6.0	1	3	3 - 4	B3
		8.0	1	2 - 3	2 - 3	B3
18 x 24	12.7 x 18.7	2.5	4	11	12	B1
			5	7 - 8	8	B2
		3.0	3	9 - 10	10 - 11	B1
			4	6 - 7	7	B2
		4.0	2	7	7 - 8	B1
			3	4 - 5	5	B2
		5.0	2	5 - 6	6	B1
				3 - 4	4	B2
		6.0	1	4 - 5	5	B1
			2	3	3 - 4	B2
		8.0	1	3 - 4	3 - 4	B1
				2 - 3	2 - 3	B2
24 dia.	Marking plate	2.5	3	6	6	B4
		3.0	2	5	6	B4
		4.0	2	3	4	B4
		5.0	1	2	3	B4
		6.0	1	2	3	B4
		8.0	1	2	2	B4
24 x 24	16.9 x 16.9	2.5	4	9	10	B3
		3.0	3	7 - 8	9	B3
		4.0	2	4 - 5	5	B3
		5.0	2	4	4 - 5	B3
		6.0	1	4	4	B3
		8.0	1	2	2	B3

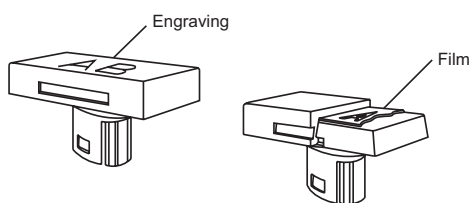

B1

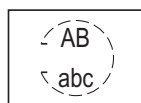

B2

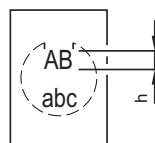

B3

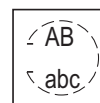

B4



Legend plates with mounting hole 22.5 mm dia

All dimensions in mm

Dimension	Height of letters h	Number of lines	Number of (target value) letters per line	Line spacing d	Image
30 x 42	3.0	1	14	4.5	B1
		2	14	2	B2
	4.0	1	10	4	B1
	8.0	1	5	2	B1
30 x 50	3.0	1	11	8.5	B3
		2	11	6	B3
	4.0	1	7	10	B3
	8.0	1	4	6	B3
42 x 42	3.0	1	20	4.5	B1
		2	20	2	B2
	4.0	1	14	4	B1
	8.0	1	7	2	B1

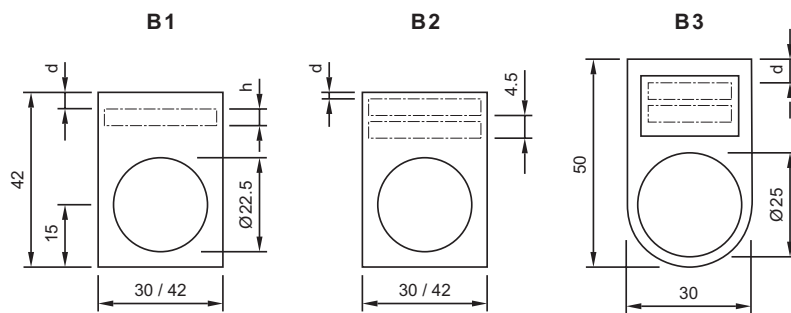

Component layout

1 Diode element page 35

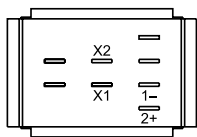

2 Diode element page 35

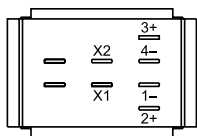

3 Lamp element page 34

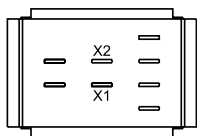

4 Switching element for Pushbutton | Keylock- and Selector switch 2 positions page 36

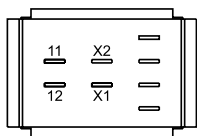

5 Switching element for Pushbutton | Keylock- and Selector switch 2 positions page 36

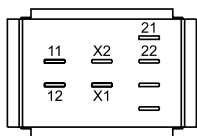

6 Switching element for Pushbutton | Keylock- and Selector switch 2 positions page 36

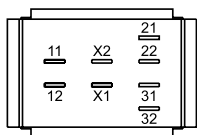

7 Switching element for Pushbutton | Keylock- and Selector switch 2 positions page 36

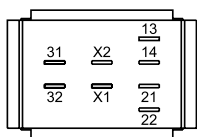

8 Switching element for Keylock- and Selector switch 3 positions page 37

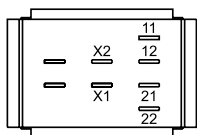

9 Switching element for Keylock- and Selector switch 3 positions page 37

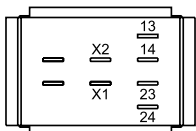

10 Switching element for Keylock- and Selector switch 3 positions page 37

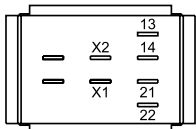

11 Switching element for Pushbutton | Keylock- and Selector switch 2 positions page 36

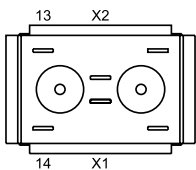

12 Switching element for Pushbutton | Keylock- and Selector switch 2 positions page 36

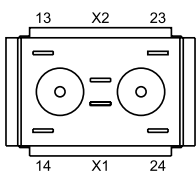

13 Switching element for Pushbutton | Keylock- and Selector switch 2 positions page 36

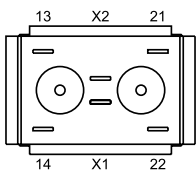

14 Switching element for Pushbutton | Keylock- and Selector switch 2 positions page 36

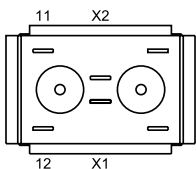

15 Switching element for Pushbutton | Keylock- and Selector switch 2 positions page 36

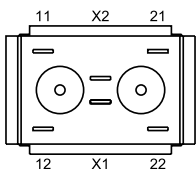

16 Switching element for Keylock- and Selector switch 3 positions page 37

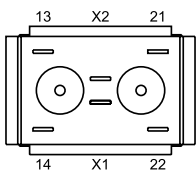

17 Switching element for Keylock- and Selector switch 3 positions page 37

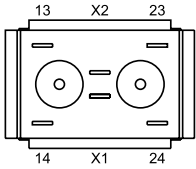

18 Switching element for Keylock- and Selector switch 3 positions page 37

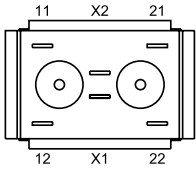

19 Switching element for Emergency-stop pushbutton page 37

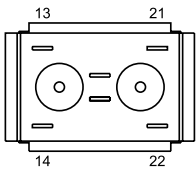

20 Switching element for Emergency-stop pushbutton page 37

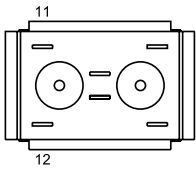

21 Switching element for Emergency-stop pushbutton page 37

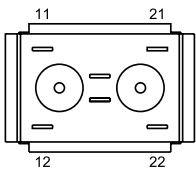

22 Switching element for Pushbutton | Keylock- and Selector switch 2 positions page 36

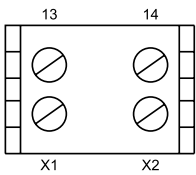

23 Switching element for Pushbutton | Keylock- and Selector switch 2 positions page 36

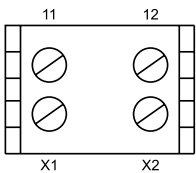

24 Switching element for Pushbutton | Keylock- and Selector switch 2 positions page 36

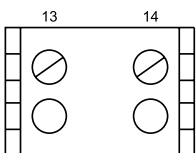

25 Switching element for Pushbutton | Keylock- and Selector switch 2 positions page 36 | Switching element for Emergency-stop pushbutton page 37

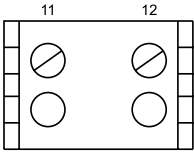

26 Switching element for Pushbutton | Keylock- and Selector switch 2 positions page 36 | Switching element for Keylock- and Selector switch 3 positions page 37 | Switching element for Emergency-stop pushbutton page 37

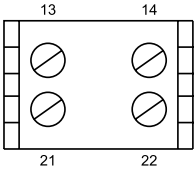

27 Switching element for Pushbutton | Keylock- and Selector switch 2 positions page 36 | Switching element for Keylock- and Selector switch 3 positions page 37

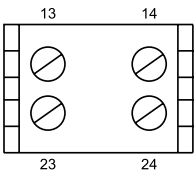

28 Switching element for Pushbutton | Keylock- and Selector switch 2 positions page 36

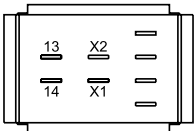

29 Switching element for Pushbutton | Keylock- and Selector switch 2 positions page 36 | Switching element for Keylock- and Selector switch 3 positions page 37 | Switching element for Emergency-stop pushbutton page 37

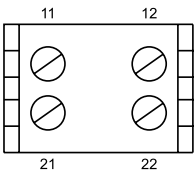

30 Flasher element page 35

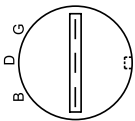

31 Lamp element page 34

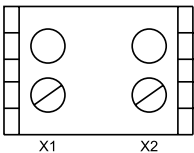

32 Switching element for Pushbutton | Keylock- and Selector switch 2 positions page 36

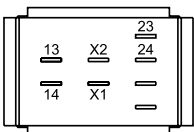

33 Switching element for Pushbutton | Keylock- and Selector switch 2 positions page 36

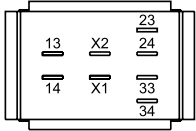

34 Switching element for Pushbutton | Keylock- and Selector switch 2 positions page 36

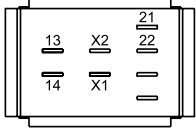

35 Switching element for Pushbutton | Keylock- and Selector switch 2 positions page 36

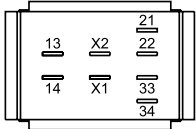

36 Switching element for Pushbutton | Keylock- and Selector switch 2 positions page 36

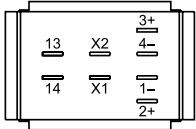

37 PCB plug-in base page 38

Drilling plan (Element side)
Through-connection recommended

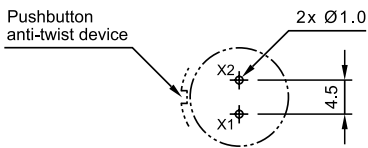

Libraries for the PCB layout-system p-cad 200X see : www.pcad.com/recources/libraries Third-party Libraries

38 PCB plug-in base page 38

Drilling plan (Elementside)
Through-connection recommended

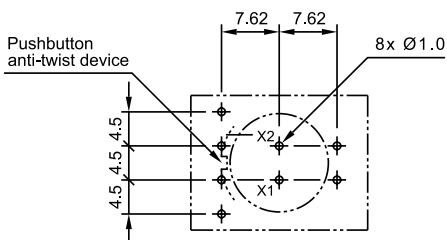

Libraries for the PCB layout-system p-cad 200X see : www.pcad.com/recources/libraries Third-party Libraries

39 PCB plug-in base page 38

Drilling plan (Elementside)
Trough-connection recommended

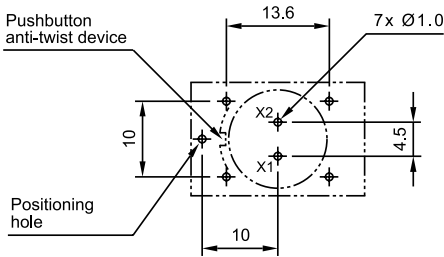

Libraries for the PCB layout-system p-cad 200X see : www.pcad.com/recurces/libraries Third-party Libraries

Mounting dimensions

1 Indicator complete page 12 | **Indicator actuator** page 12 | **Illuminated pushbutton actuator** page 13 | **Keylock switch actuator 2 positions** page 16 | **Keylock switch actuator 3 positions** page 17 | **Selector switch actuator 2 positions** page 18 | **Selector switch actuator 3 positions** page 19 | **Blind plug, raised mounting** page 33

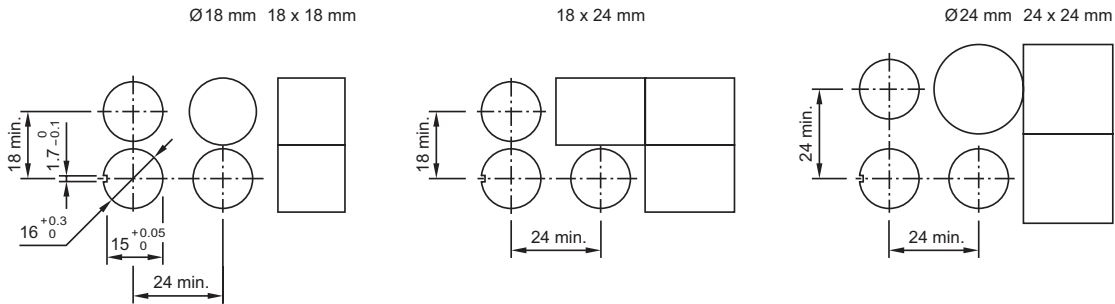

2 Emergency-stop pushbutton actuator, foolproof EN IEC 60947-5-5 page 14 | **Emergency-stop pushbutton actuator, foolproof** page 15 | **Mushroom-head pushbutton actuator** page 15

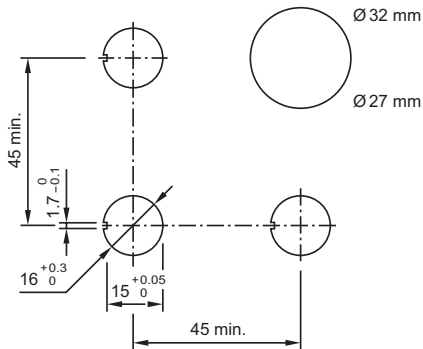

3 Indicator complete, flush mounting page 20 | Indicator actuator, flush mounting page 20 | Illuminated pushbutton actuator, flush mounting page 21 | Mushroom-head pushbutton actuator, flush mounting page 21 | Keylock switch actuator 2 positions, flush mounting page 22 | Keylock switch actuator 3 positions, flush mounting page 23 | Selector switch actuator 2 positions, flush mounting page 24 | Selector switch actuator 3 positions, flush mounting page 25 | Potentiometer, flush mounting page 26 | Front bezel set for Indicators and Illuminated pushbutton, flush mounting page 31 | Front bezel set for Mushroom-head pushbutton, flush mounting page 31 | Front bezel set for Keylock switch, flush mounting page 32 | Front bezel set for Selector switch, flush mounting page 32 | Protective cover, flush mounting page 33 | Blind plug, flush mounting page 33

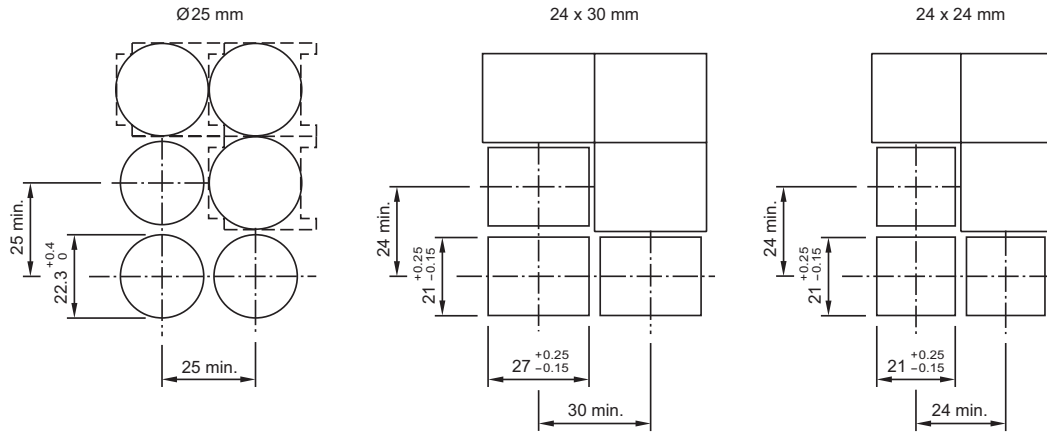

Technical drawing

1 Protective cover, raised mounting page 33

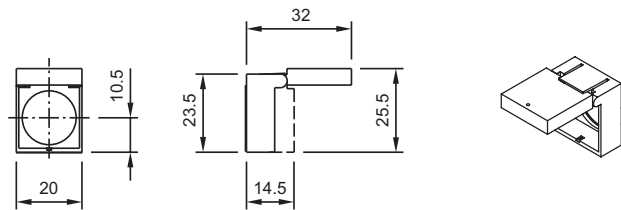

2 Protective cover, raised mounting page 33

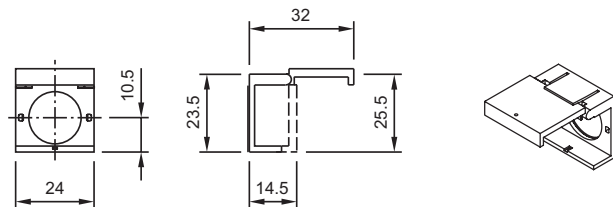

3 Indicator complete page 12

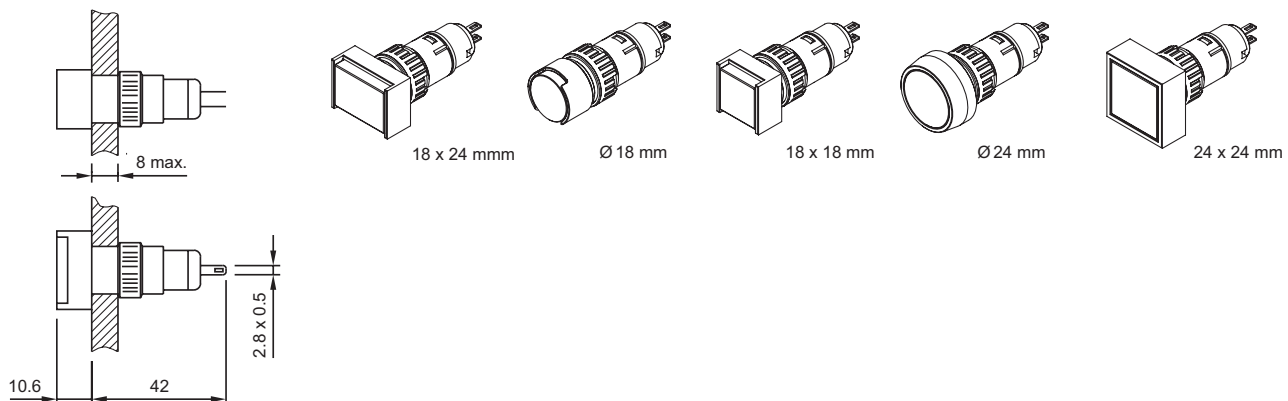

4 Indicator complete, flush mounting page 20

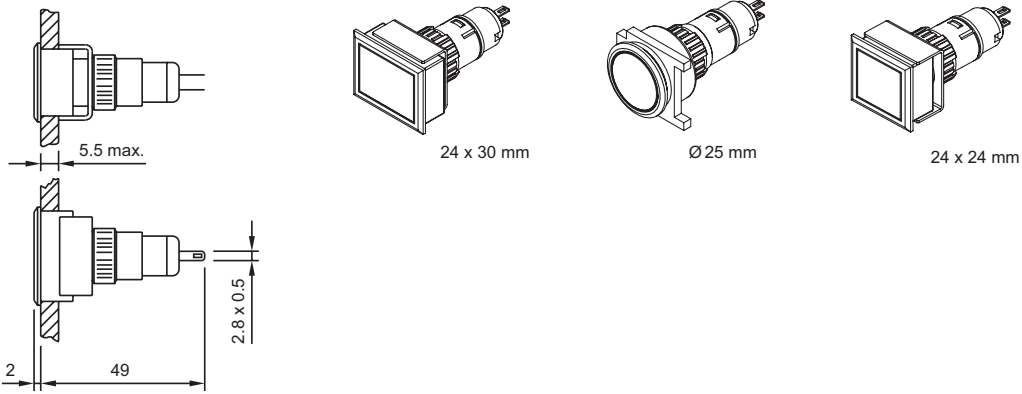

5 Protective cover, raised mounting page 33

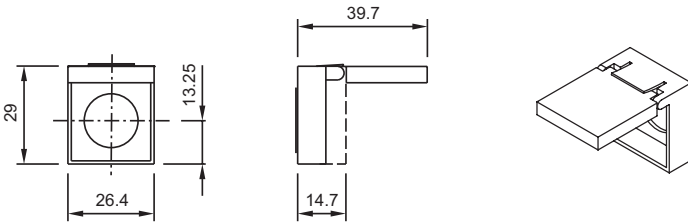

6 Protective cover, flush mounting page 33

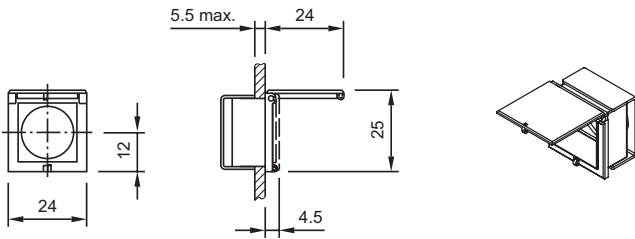

7 Protective cover, flush mounting page 33

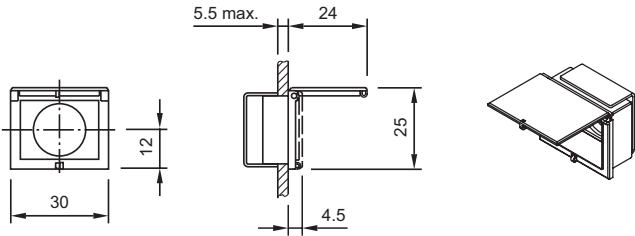

8 Protective cover, flush mounting page 33

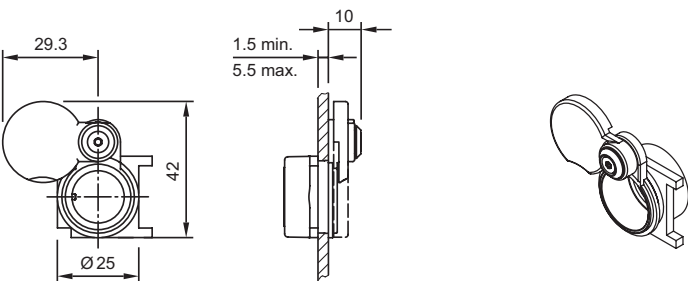

9 Potentiometer, flush mounting page 26

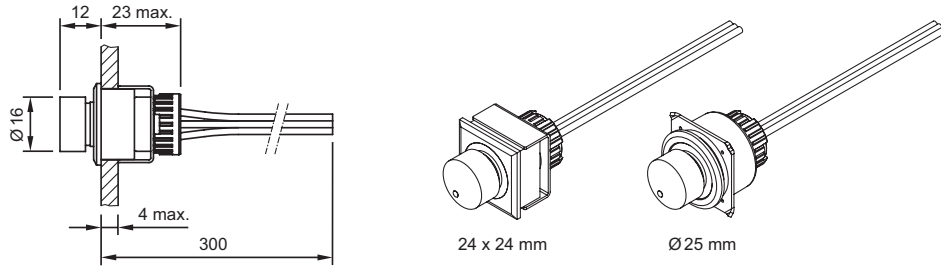

10 Legend plate page 30

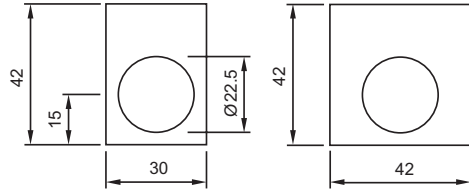

11 Legend frame page 30 | Legend plate insert page 31

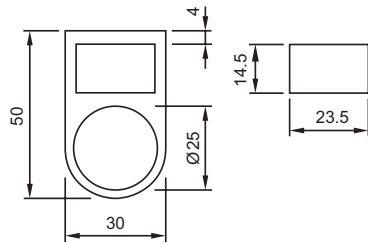

12 Indicator actuator page 12

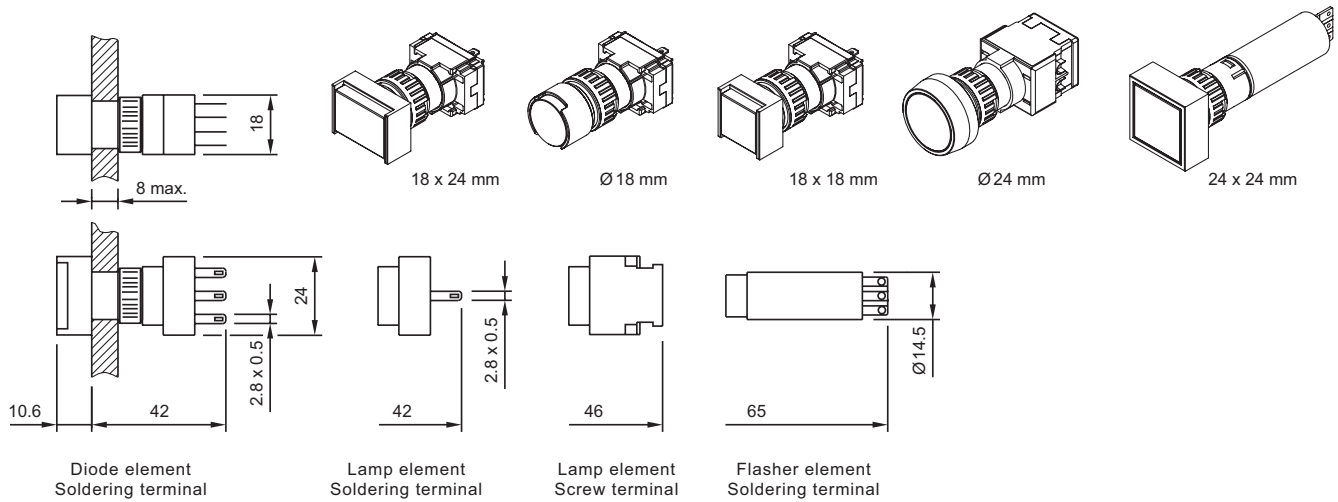

13 Mushroom-head pushbutton actuator page 15

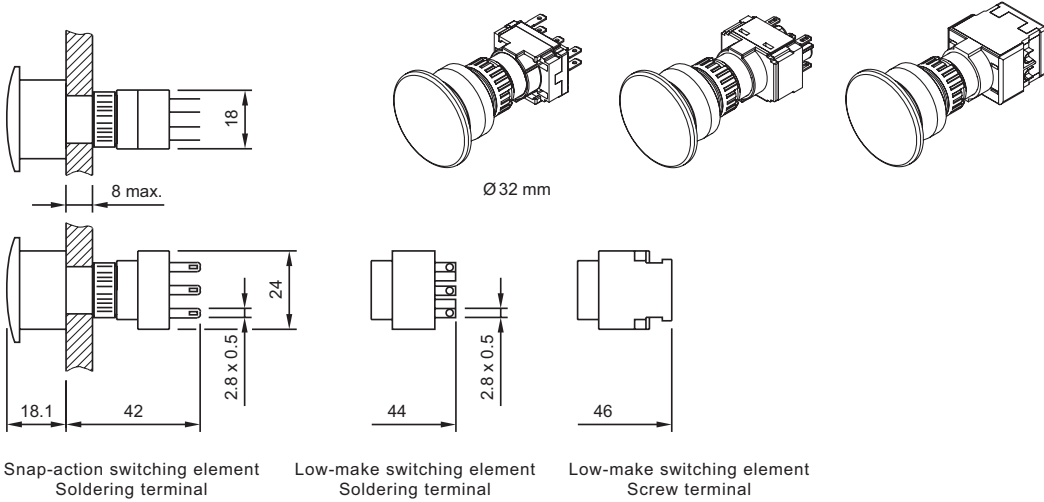

14 Illuminated pushbutton actuator page 13

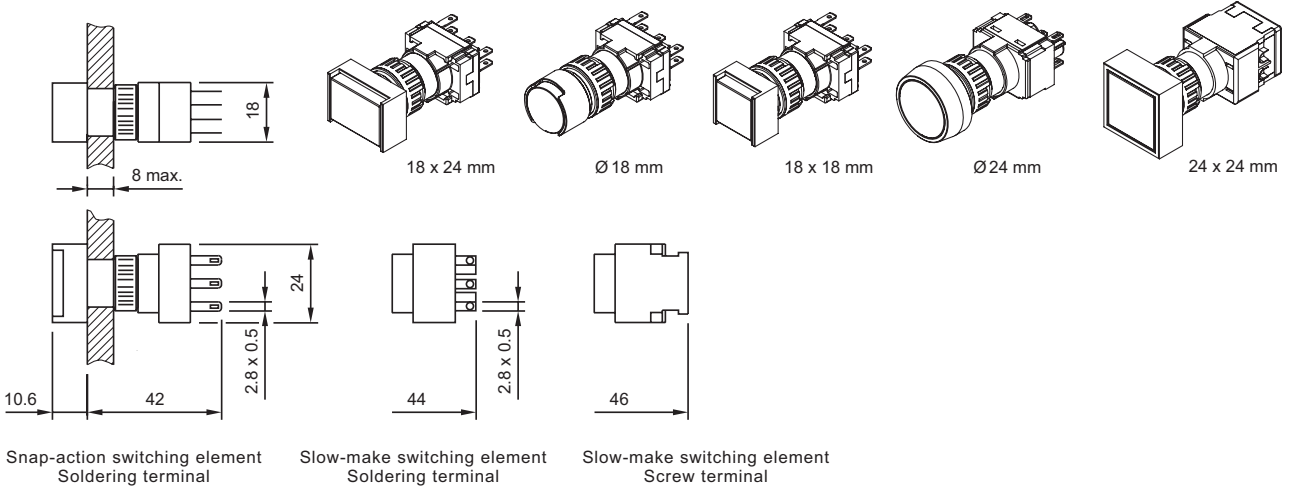

15 Keylock switch actuator 2 positions page 16 | Keylock switch actuator 3 positions page 17

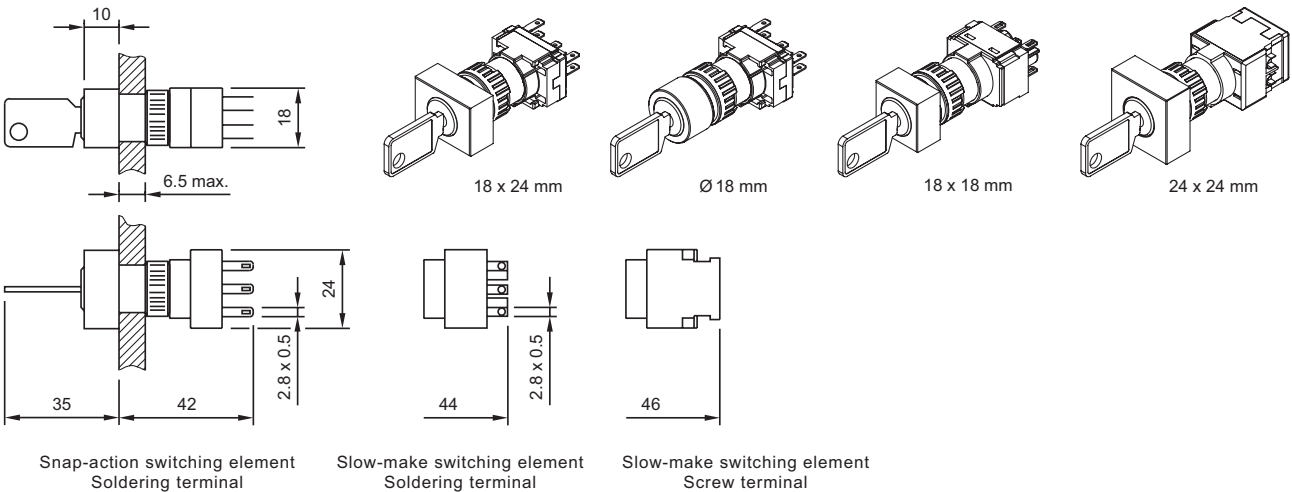

16 Selector switch actuator 2 positions page 18 | **Selector switch actuator 3 positions** page 19

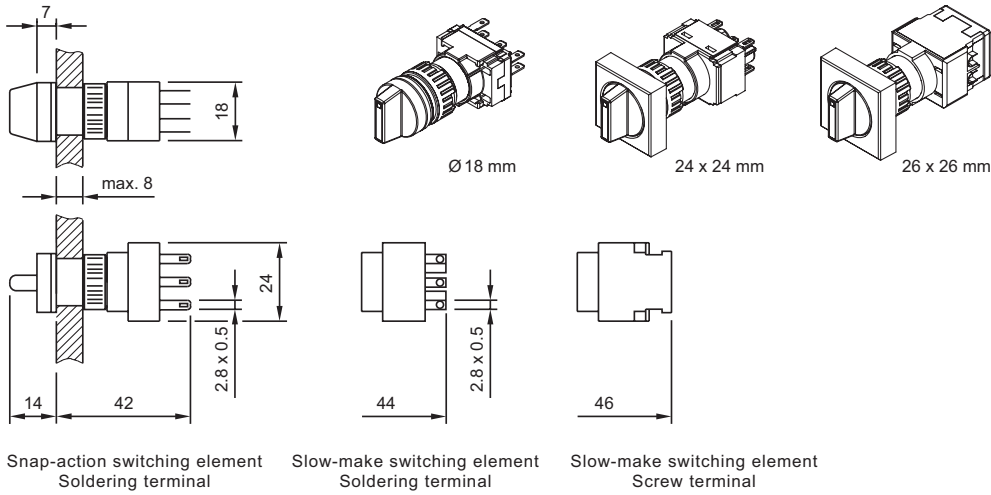

17 Emergency-stop pushbutton actuator, foolproof EN IEC 60947-5-5 page 14 | **Emergency-stop pushbutton actuator, foolproof** page 15

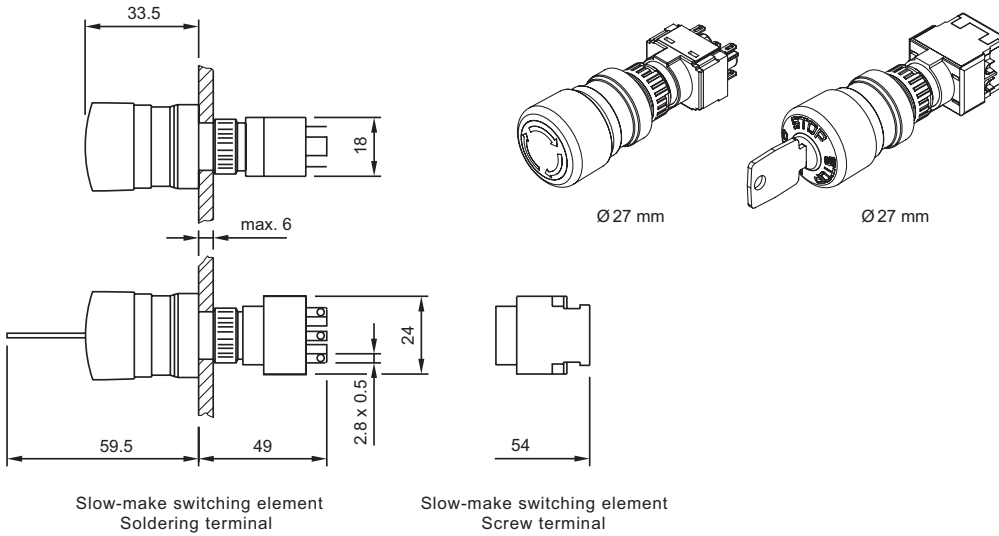

18 Illuminated pushbutton actuator, flush mounting page 21

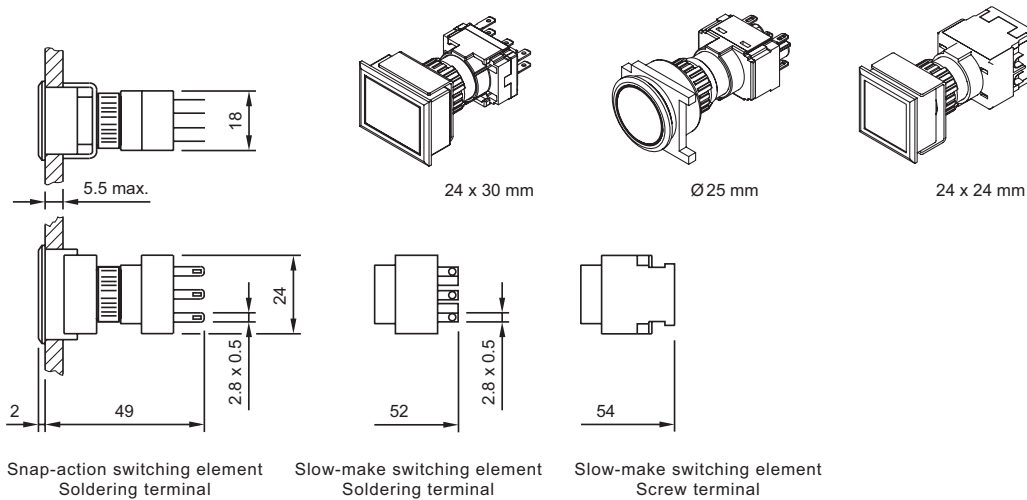

19 Indicator actuator, flush mounting page 20

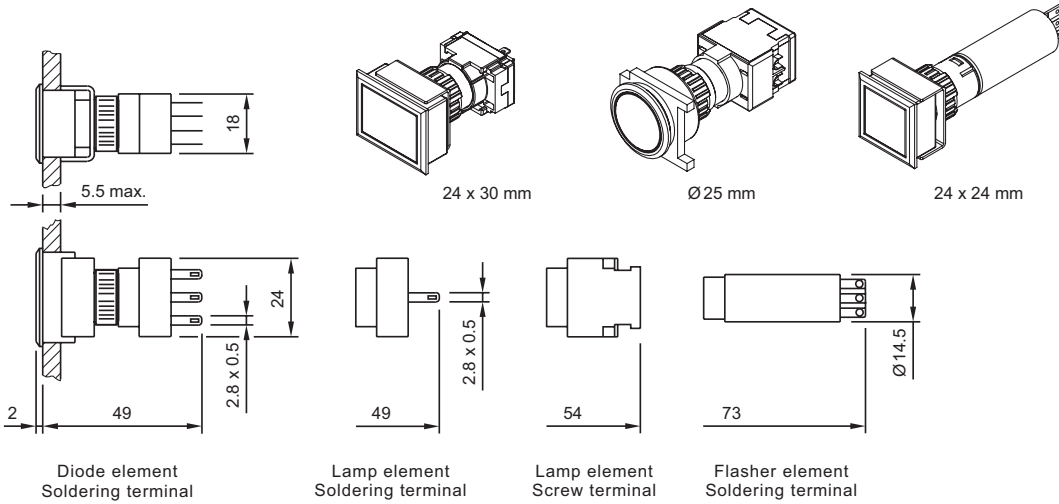

20 Keylock switch actuator 2 positions, flush mounting page 22 | Keylock switch actuator 3 positions, flush mounting page 23

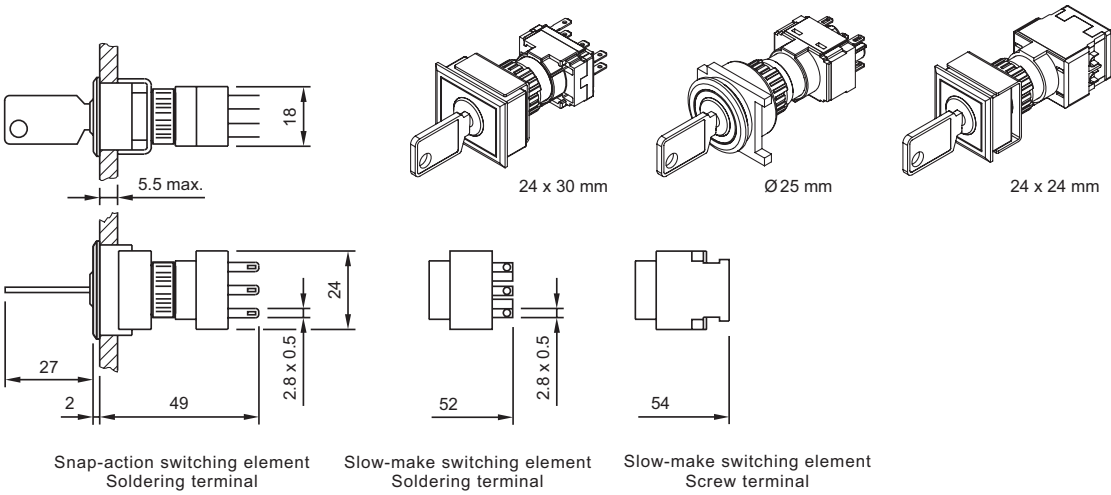

21 Selector switch actuator 2 positions, flush mounting page 24 | Selector switch actuator 3 positions, flush mounting page 25

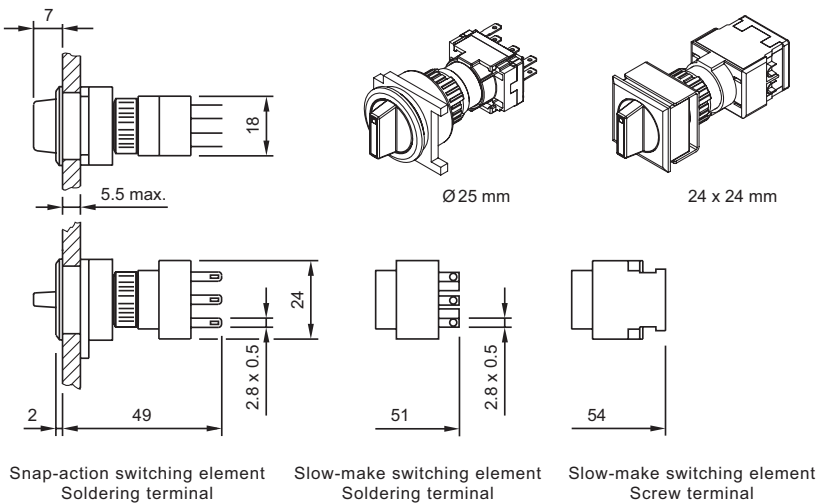

22 Mushroom-head pushbutton actuator, flush mounting page 21

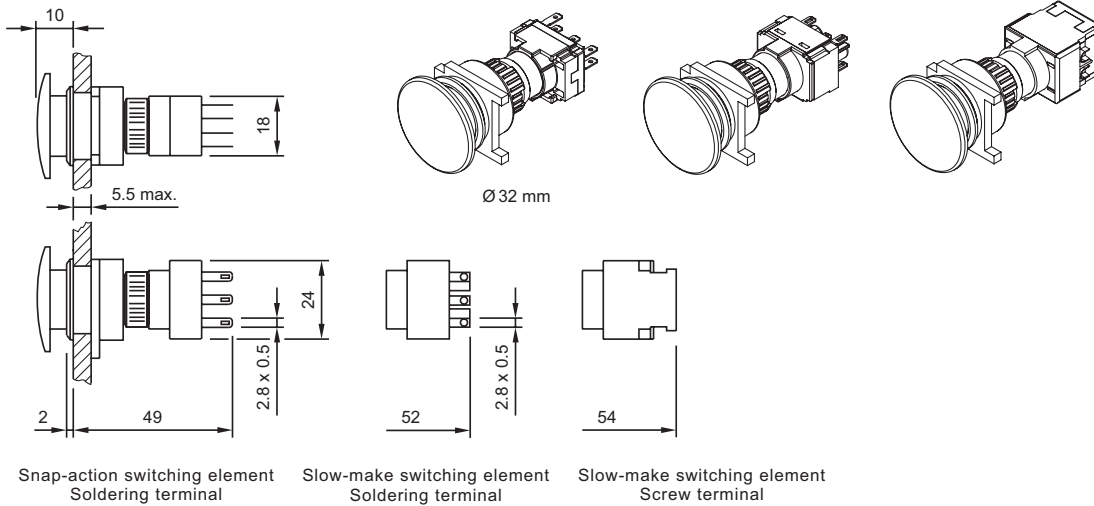

Circuit drawing

1 Potentiometer, flush mounting page 26

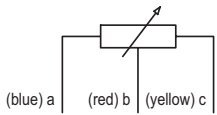

2 Illuminated pushbutton actuator, flush mounting page 21 | Mushroom-head pushbutton actuator, flush mounting page 21



3 Illuminated pushbutton actuator, flush mounting page 21 | Mushroom-head pushbutton actuator, flush mounting page 21



4 Indicator complete page 12 | Indicator actuator page 12 | Indicator complete, flush mounting page 20 | Indicator actuator, flush mounting page 20 | Lamp element page 34



5 Emergency-stop pushbutton actuator, foolproof EN IEC 60947-5-5 page 14 | Emergency-stop pushbutton actuator, foolproof page 15



6 Illuminated pushbutton actuator page 13 | Mushroom-head pushbutton actuator page 15

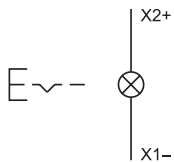

7 Selector switch actuator 2 positions page 18 | Selector switch actuator 2 positions, flush mounting page 24

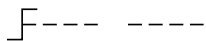

8 Selector switch actuator 2 positions page 18 | Selector switch actuator 2 positions, flush mounting page 24

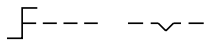

9 Selector switch actuator 3 positions page 19 | **Selector switch actuator 3 positions, flush mounting** page 25



10 Selector switch actuator 3 positions page 19 | **Selector switch actuator 3 positions, flush mounting** page 25



11 Selector switch actuator 3 positions page 19 | **Selector switch actuator 3 positions, flush mounting** page 25



12 Selector switch actuator 3 positions page 19 | **Selector switch actuator 3 positions, flush mounting** page 25



13 Illuminated pushbutton actuator page 13 | **Mushroom-head pushbutton actuator** page 15

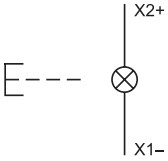

14 Keylock switch actuator 3 positions page 17 | **Keylock switch actuator 3 positions, flush mounting** page 23



15 Keylock switch actuator 3 positions page 17 | **Keylock switch actuator 3 positions, flush mounting** page 23



16 Keylock switch actuator 2 positions page 16 | **Keylock switch actuator 2 positions, flush mounting** page 22



17 Keylock switch actuator 2 positions page 16 | **Keylock switch actuator 2 positions, flush mounting** page 22

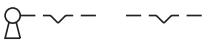

18 Keylock switch actuator 3 positions page 17 | **Keylock switch actuator 3 positions, flush mounting** page 23



19 Keylock switch actuator 3 positions page 17 | **Keylock switch actuator 3 positions, flush mounting** page 23



20 Diode element page 35

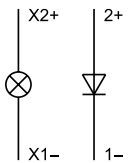

21 Diode element page 35

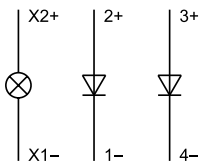

22 Switching element for Pushbutton | Keylock- and Selector switch 2 positions page 36



23 Switching element for Pushbutton | Keylock- and Selector switch 2 positions page 36

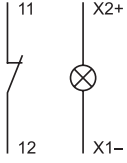

24 Switching element for Pushbutton | Keylock- and Selector switch 2 positions page 36 | Switching element for Keylock- and Selector switch 3 positions page 37

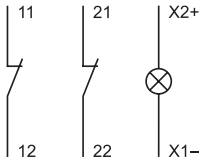

25 Switching element for Pushbutton | Keylock- and Selector switch 2 positions page 36

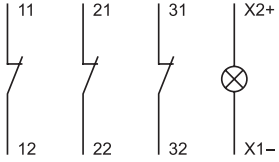

26 Switching element for Pushbutton | Keylock- and Selector switch 2 positions page 36



27 Switching element for Pushbutton | Keylock- and Selector switch 2 positions page 36

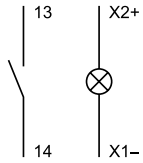

28 Switching element for Pushbutton | Keylock- and Selector switch 2 positions page 36

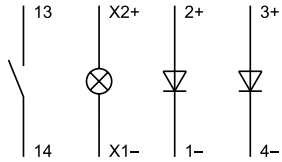

29 Switching element for Pushbutton | Keylock- and Selector switch 2 positions page 36

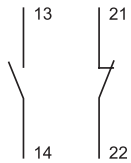

30 Switching element for Pushbutton | Keylock- and Selector switch 2 positions page 36 | Switching element for Keylock- and Selector switch 3 positions page 37

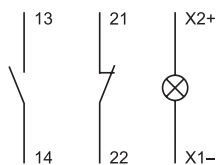

31 Switching element for Pushbutton | Keylock- and Selector switch 2 positions page 36

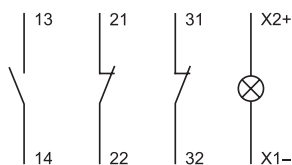

32 Switching element for Pushbutton | Keylock- and Selector switch 2 positions page 36

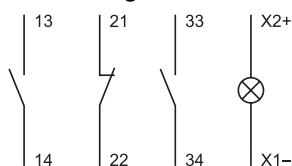

33 Switching element for Pushbutton | Keylock- and Selector switch 2 positions page 36 | Switching element for Keylock- and Selector switch 3 positions page 37

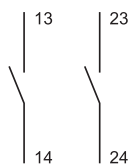

34 Switching element for Pushbutton | Keylock- and Selector switch 2 positions page 36 | Switching element for Keylock- and Selector switch 3 positions page 37

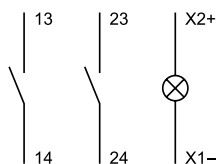

35 Switching element for Pushbutton | Keylock- and Selector switch 2 positions page 36

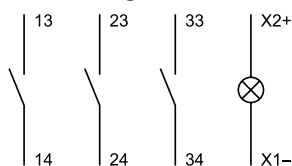

36 Switching element for Pushbutton | Keylock- and Selector switch 2 positions page 36 | Switching element for Keylock- and Selector switch 3 positions page 37 | Switching element for Emergency-stop pushbutton page 37

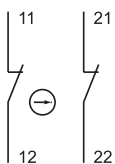

37 Switching element for Keylock- and Selector switch 3 positions page 37 | Switching element for Emergency-stop pushbutton page 37

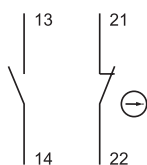

38 Switching element for Emergency-stop pushbutton page 37

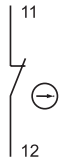

Index from Typ-Nr.

Typ-Nr.	Page	Typ-Nr.	Page	Typ-Nr.	Page
01-907	42	52-928.60	29	61-2605.0/D	17
02-905	41	52-928.9	29	61-2605.0/D	23
02-912.1	40	52-929.20	29	61-2606.0/D	17
02-912.2	40	52-929.30	29	61-2606.0/D	23
02-912.3	40	52-929.40	29	61-2607.0/D	17
02-912.4	40	52-929.50	29	61-2607.0/D	23
10-1306.1349	39	52-929.60	29	61-2701.0/D	17
10-1307.1369	39	52-929.8	29	61-2701.0/D	23
10-1309.1309	39	52-929.9	29	61-2703.0/D	17
10-1310.1319	39	52-950.0	31	61-2703.0/D	23
10-1311.1249	39	52-952.0	31	61-2705.0/D	17
10-1312.1229	39	61-0000.02	20	61-2705.0/D	23
10-1313.1209	39	61-0009.0	20	61-2801.0/D	17
10-1313.1249	39	61-0010.02	12	61-2801.0/D	23
10-1316.1179	39	61-0019.0	12	61-2802.0/D	17
10-1316.1209	39	61-0020.02	12	61-2802.0/D	23
10-1319.1179	39	61-0029.0	12	61-2804.0/D	17
10-1319.1199	39	61-0030.02	12	61-2804.0/D	23
10-2J06.3142	39	61-0039.0	12	61-3440.4/1	14
10-2J06.3144	39	61-0040.02	12	61-3440.4/1S	14
10-2J06.3145	39	61-0049.0	12	61-3440.4/2	14
10-2J06.3146	39	61-0050.02	12	61-3440.4/5	14
10-2J06.3149	39	61-0059.0	12	61-3440.4/8	15
10-2J09.1062	39	61-1100.0	21	61-3440.4/D	14
10-2J09.1064	39	61-1100.0	21	61-4110.0	18
10-2J09.1065	39	61-1110.0	13	61-4110.0	24
10-2J09.1066	39	61-1120.0	13	61-4210.0	18
10-2J09.1069	39	61-1130.0	13	61-4210.0	24
10-2J12.1062	39	61-1140.0	13	61-4510.0	19
10-2J12.1064	39	61-1140.0	15	61-4510.0	25
10-2J12.1065	39	61-1150.0	13	61-4610.0	19
10-2J12.1066	39	61-1200.0	21	61-4610.0	25
10-2J12.1069	39	61-1200.0	21	61-4710.0	19
10-2J13.1062	39	61-1210.0	13	61-4710.0	25
10-2J13.1064	39	61-1220.0	13	61-4810.0	19
10-2J13.1065	39	61-1230.0	13	61-4810.0	25
10-2J13.1066	39	61-1240.0	13	61-4970.10	26
10-2J13.1069	39	61-1240.0	15	61-4970.13	26
10-2J19.1042	39	61-1250.0	13	61-5441.0/K	15
10-2J19.1044	39	61-1300.0	21	61-5441.4/K	14
10-2J19.1045	39	61-1300.0	21	61-8000.05	35
10-2J19.1046	39	61-1310.0	13	61-8006.01	34
10-2J19.1049	39	61-1320.0	13	61-8006.02	34
14-987.1001	34	61-1330.0	13	61-8101.02	35
31-929	38	61-1350.0	13	61-8102.02	35
31-946	38	61-2101.0/D	16	61-8212.12	36
31-985.0	34	61-2101.0/D	22	61-8212.22	36
31-989.300	34	61-2201.0/D	16	61-8410.12	36
31-989.311	34	61-2201.0/D	22	61-8410.22	36
31-991	41	61-2203.0/D	16	61-8420.12	36
51-910	41	61-2203.0/D	22	61-8420.22	36
51-920	33	61-2205.0/D	16	61-8430.12	36
51-925	33	61-2205.0/D	22	61-8430.22	36
51-943.1	38	61-2501.0/D	17	61-8440.12	36
51-943.9	42	61-2501.0/D	23	61-8440.22	36
51-947.0	33	61-2601.0/D	17	61-8450.12	36
51-948.0	33	61-2601.0/D	23	61-8450.22	36
51-949.0	33	61-2602.0/D	17	61-8460.12	36
52-928.0	29	61-2602.0/D	23	61-8460.22	36
52-928.20	29	61-2603.0/D	17	61-8470.12	36
52-928.30	29	61-2603.0/D	23	61-8470.22	36
52-928.40	29	61-2604.0/D	17	61-8480.12	36
52-928.50	29	61-2604.0/D	23	61-8480.22	36

Index from Typ-Nr.

Typ-Nr.	Page	Typ-Nr.	Page	Typ-Nr.	Page
61-8490.12	36	61-9221.0	27	61-9480.6	42
61-8490.22	36	61-9221.8	27	61-9481.6	40
61-8520.12	37	61-9221.9	27	61-9481.6	42
61-8520.22	37	61-9226.0	27	61-9593.0	29
61-8550.12	37	61-9226.8	27	61-9593.2	29
61-8550.22	37	61-9226.9	27	61-9593.4	29
61-8574.12	37	61-9230.0	29	61-9593.5	29
61-8574.22	37	61-9230.0	29	61-9600.0	32
61-8610.11	36	61-9231.0	27	61-9600.1	32
61-8610.17	36	61-9231.8	27	61-9642.1	27
61-8610.37	36	61-9231.9	27	61-9642.1	27
61-8615.11	36	61-9236.0	27	61-9642.2	27
61-8620.17	36	61-9236.8	27	61-9642.2	27
61-8620.37	36	61-9236.9	27	61-9642.3	27
61-8625.11	36	61-9250.0	29	61-9642.3	27
61-8640.11	36	61-9251.0	27	61-9642.4	27
61-8640.17	36	61-9251.8	27	61-9642.4	27
61-8640.37	36	61-9251.9	27	61-9642.5	27
61-8645.11	36	61-9311.1	27	61-9642.5	27
61-8650.17	36	61-9311.2	27	61-9642.6	27
61-8650.37	36	61-9311.3	27	61-9642.6	27
61-8655.11	36	61-9311.4	27	61-9642.7	27
61-8670.17	36	61-9311.5	27	61-9642.7	27
61-8670.37	36	61-9311.6	27	61-9671.1	27
61-8675.11	36	61-9311.7	27	61-9671.2	27
61-8720.17	37	61-9321.1	27	61-9671.3	27
61-8720.37	37	61-9321.2	27	61-9671.4	27
61-8725.11	37	61-9321.3	27	61-9671.5	27
61-8745.11	37	61-9321.4	27	61-9671.6	27
61-8745.17	37	61-9321.5	27	61-9671.7	27
61-8745.37	37	61-9321.6	27	61-9681.1	27
61-8750.17	37	61-9321.7	27	61-9681.2	27
61-8755.11	37	61-9326.2	27	61-9681.3	27
61-8755.11	37	61-9326.3	27	61-9681.4	27
61-8755.17	37	61-9326.4	27	61-9681.5	27
61-8755.37	37	61-9326.5	27	61-9681.6	27
61-8770.17	37	61-9326.6	27	61-9681.7	27
61-8770.37	37	61-9326.7	27	61-9707.7	28
61-8775.11	37	61-9331.1	27	61-9711.0	42
61-8775.11	37	61-9331.2	27	61-9730.0	41
61-8775.17	37	61-9331.3	27	61-9740.0	42
61-8775.37	37	61-9331.4	27	61-9771.0	27
61-9028.0	30	61-9331.5	27	61-9771.8	27
61-9028.20	30	61-9331.6	27	61-9771.9	27
61-9028.30	30	61-9331.7	27	61-9781.0	27
61-9028.40	30	61-9336.2	27	61-9781.8	27
61-9028.50	30	61-9336.3	27	61-9781.9	27
61-9028.60	30	61-9336.4	27	61-9820.1	38
61-9028.9	30	61-9336.5	27	61-9821.1	38
61-9029.20	30	61-9336.6	27	61-9823	38
61-9029.30	30	61-9336.7	27	61-9830	38
61-9029.40	30	61-9351.1	27	61-9830.2	38
61-9029.50	30	61-9351.2	27	61-9831.2	38
61-9029.60	30	61-9351.3	27	61-9841.0	28
61-9029.8	30	61-9351.4	27	61-9841.0	28
61-9029.9	30	61-9351.5	27	61-9841.2	28
61-9210.0	29	61-9351.6	27	61-9841.2	28
61-9210.0	29	61-9351.7	27	61-9841.4	28
61-9211.0	27	61-9450.0	33	61-9841.4	28
61-9211.8	27	61-9451.0	33	61-9841.5	28
61-9211.9	27	61-9452.0	33	61-9841.5	28
61-9220.0	29	61-9453.0	33	61-9841.6	28
61-9220.0	29	61-9480.5	40	61-9841.6	28

Index from Typ-Nr.

<u>Typ-Nr.</u>	<u>Page</u>	<u>Typ-Nr.</u>	<u>Page</u>	<u>Typ-Nr.</u>	<u>Page</u>
61-9841.8	28				
61-9841.8	28				
61-9841.8A	28				
61-9841.8A	28				
61-9912.0	41				
61-9915.0	41				
61-9920.0	33				
61-9921.0	33				
61-9922.0	33				
61-9924.0	33				
61-9927.2	32				
61-9930.0	31				
61-9930.0	32				
61-9931.0	31				
61-9931.0	32				
61-9932.0	32				
61-9932.0	32				
61-9932.1	32				
61-9932.1	32				
61-9932.10	32				
61-9932.10	32				
61-9933.0	31				
61-9933.0	31				
61-9933.1	31				
61-9933.1	31				
61-9933.10	31				
61-9933.10	31				
61-9934.8	31				
61-9936.0	32				
61-9960	41				
61-9965	40				
61-9970.0	40				
61-9970.1	40				
61-9970.2	40				
61-9970.3	40				
61-9980.0	30				
704.945.6	40				
704.945.6	42				
704.962.0	30				
704.962.5	30				
704.968.0	31				
704.968.1	31				
84-9103.7	32				
K61-999.100	41				

	EAO AG Tannwaldstrasse 88 4601 Olten, Switzerland
E-mail	info@eao.com
Website	www.eao.com
	Belgium
Phone	+32/2 456 00 10
E-mail	sales.ebl@eao.com
	China
Phone	+852/27 86 91 41
E-mail	sales.ehk@eao.com.hk
	France
Phone	+33/1 64 43 37 37
E-mail	sales.es@eao.com
	Germany
Phone	+49/201 85 87 0
E-mail	sales.ede@eao.com
	Japan
Phone	+81/3 5401 0953
E-mail	sales.esj@eao.com
	Netherlands
Phone	+31/78 653 17 00
E-mail	sales.enl@eao.com
	Sweden
Phone	+46/8 683 86 60
E-mail	sales.esw@eao.com
	Switzerland
Phone	+41/62 388 95 00
E-mail	sales.ech@eao.com
	United Kingdom
Phone	+44/1444 236000
E-mail	sales.euk@eao.com
	USA
Phone	+1/203 877 4577
E-mail	sales.eus@eao.com
	Other Countries
Fax	+41/62 296 21 62
E-mail	info@eao.com
Website	www.eao.com