

FWF TV

IEEE 1394A Connection System for Harsh Environments



With FW Field, you can insert a standard IEEE1394A cordset into a metallic plug which will protect it from shocks, dust and fluids.

No hazardous on-field cabling and grounding!

This metallic plug is connected into a receptacle, using a Tri Start Thread coupling mechanism (MIL-DTL-38999 series III type) with anti-decoupling device for high vibrations.

Applications

- Embedded Computers
- Video
- Railways
- Battelfield Communication Systems
- Naval & Shipboard Systems
- Robotics & Automation
- Process Control
- Rugged Communications

Main characteristics

- No assembly tools required
- Sealed against fluids and dusts (IP68)
- No time-consuming in-field cabling operation necessary
- **Tri-start thread coupling mechanism (MIL-DTL-38999 series III type) with anti-decoupling device**
- FW plug retention in the receptacle: 100 N in the axis
- Mating cycles: 500 minimum
- Improved EMI protection

Environmental Protection

- Sealing (mated): IP68 (Temporary immersion - 1 meter up to 30 minutes)
- Salt Spray: 48 h with Nickel plating
> 500 h with Olive Drab Cadmium
- Fire Retardant / Low Smoke: UL94 V0 and NF F 16 101 & 16 102
- Vibrations: 10 – 500 Hz, 10 g, 3 axes: no discontinuity > 1micro s
- Shocks: IK06: weight of 250 g drop from 40 cm [15.75 in] onto connectors (mated pair)
- Humidity: 21 days, 43°C, 98% humidity
- Temperature Range: - 40°C / +85°C

Data Transmission

IEEE 1394a-2000
400 Mbits/second over 4.5 meters

Part Number Code

Series	FWF TV	2	1	G
IEEE1394 Field TV				
Shell Type				
6:	Plug			
2:	Square Flange Receptacle			
2PE:	Square flange receptacle with metal backshell (type 1) & with metal backshell + plastic gland (type 2)			
7:	Jam Nut Receptacle			
7PE:	Jam nut receptacle with metal backshell (type 1) & with metal backshell + plastic gland (type 2)			
Back Terminations (Receptacles only)				
1:	IEEE 1394 receptacle			
2:	Solder Board (6 tinned holes)			
Shell Plating				
N:	Nickel - ROHS Compliant			
G:	Olive Drab Cadmium			

- Examples:
- Olive Drab Cadmium Plug: FWF TV 6G
 - Olive Drab Cadmium Square Flange Receptacle, IEEE 1394 front & back: FWF TV 21G
 - Olive Drab Cadmium Jam Nut Receptacle, IEEE 1394 front and back: FWF TV 71G
 - Nickel Jam Nut Receptacle, solder board termination: FWF TV 72N

Plug

- Shell type 6

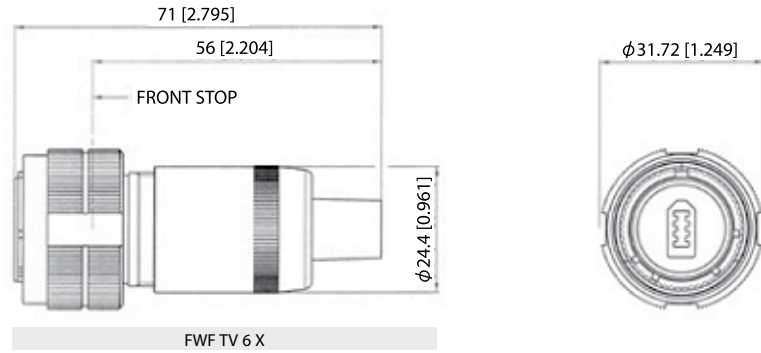

Receptacles

- Square flange receptacle
4 mounting holes: Shell type 2

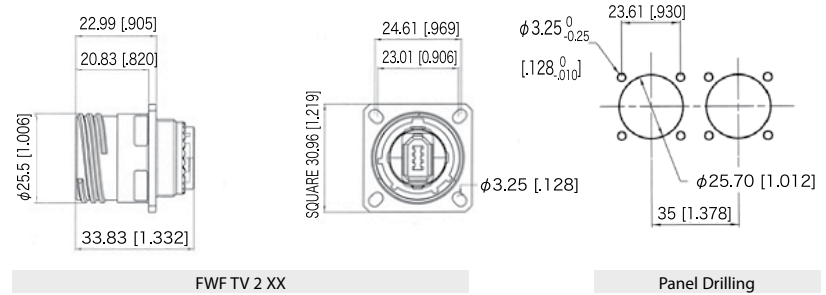

- Jam nut receptacle
Hexagonal Nut mounting: Shell type 7

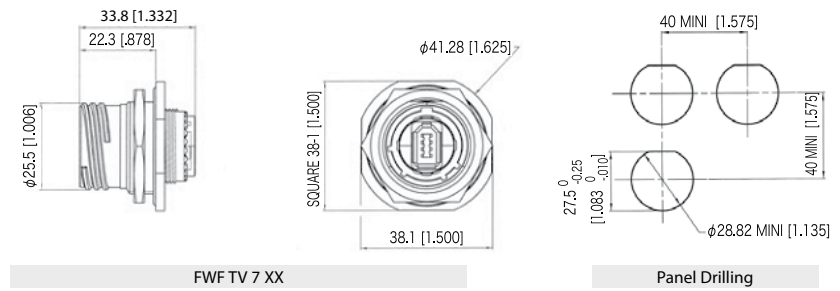

- Receptacles with backshell:
Shell type 2PE and 7PE

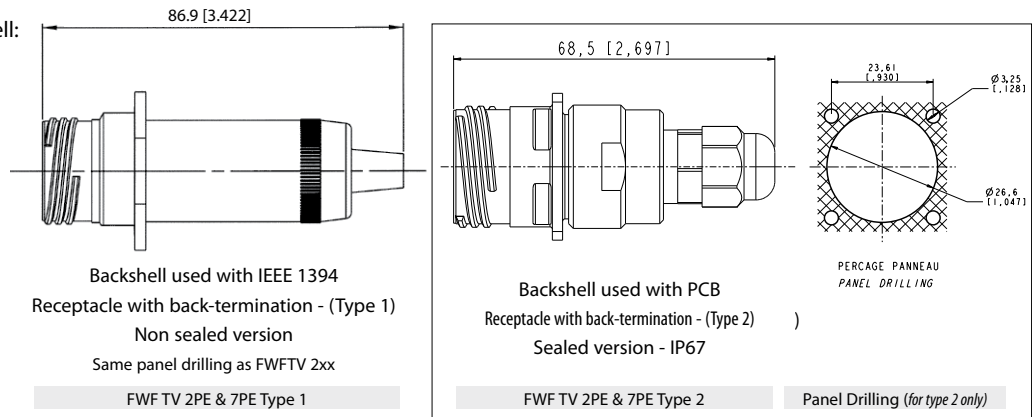

Back Terminations

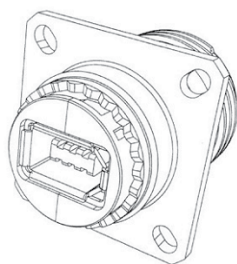

Type 1: IEEE 1394 Receptacle

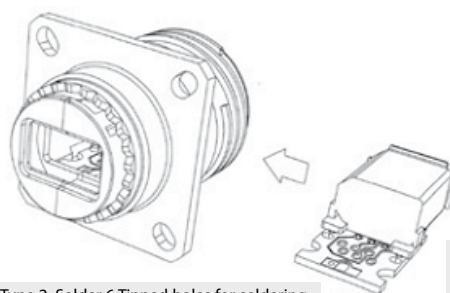

Type 2: Solder 6 Tinned holes for soldering

View of the PCB Type 2 version - with 6 tinned holes for solder termination

Assembly Instructions

Can be used with most IEEE 1394 cordset brands: No tools required!

Plug Assembly

1. If a fully sealed (IP68) assembly is required: Install the white tape around the plug to cover the 4 holes of the overmolding. If there are no holes omit this step.
2. Insert the black O Ring around the front face of the IEEE 1394 plug. This O Ring will ensure the seal.
3. Insert the IEEE 1394 cordset into the metallic backshell.
4. Insert the retention spacer laterally onto the cable (this spacer is soft so as to adapt to various overmolding styles) and slide the IEEE 1394 plug into this retention spacer.
5. Insert the friction ring laterally onto the cable cordset.
6. Insert the IEEE 1394 plug into the metallic circular shell. Note at this step that the main key is used for polarization.
7. Screw the backshell on the plug body. A spanner may be required to fully close the backshell to the circular shell.

Important Note: The sealing of the connector is not done by the black retention spacers which are slotted, but rather by the front face O-Ring (Fig 2).

Receptacle Assembly

To Solder your cable onto the PCB:

1. Attach the 2 metallized plastic inserts around the PCB (Fig 1a & 1b).
2. Insert the IEEE 1394 module from the rear of the connector.

Removing Modules

1. Insert the removal tool FWF ODE from the front
2. Push the module back with thumb.

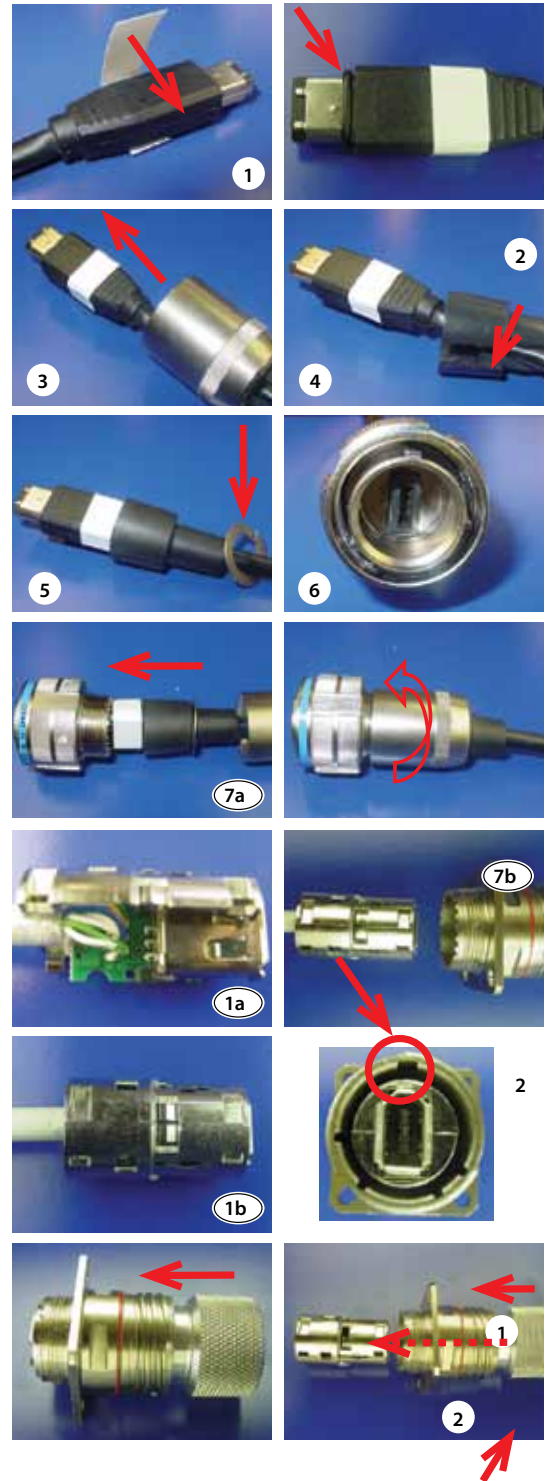

Accessories

Metallic Caps

	FWF TVC	2	G
Connector Type			
6:	Plug		
2:	Square Flange Receptacle		
7:	Jam Nut Receptacle		
Shell plating			
N:	Nickel - ROHS Compliant		
G:	Olive Drab Cadmium		

- Panel Gasket for square flange receptacle (Thickness: 0,8 mm [.031]): JE15



- Receptacle Insert removal tool: FWF ODE

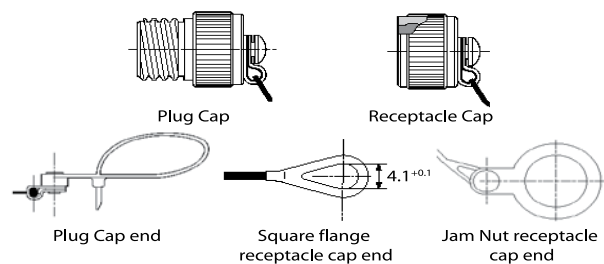

SELF CLOSING CAP

For IEEE1394 Receptacles



This Self Closing Cap automatically protects the RJ Field square flange receptacles (MIL-C-26482 type), protecting your system from dust and water projections. The same cap can be used to protect USB and IEEE1394 receptacles. A spring automatically closes the upper part of the cap when either the RJ Field plug, RJ45 cordset, USB or IEEE1394 cordset, or USB key are removed from the receptacle.

FWF 21 X SCC

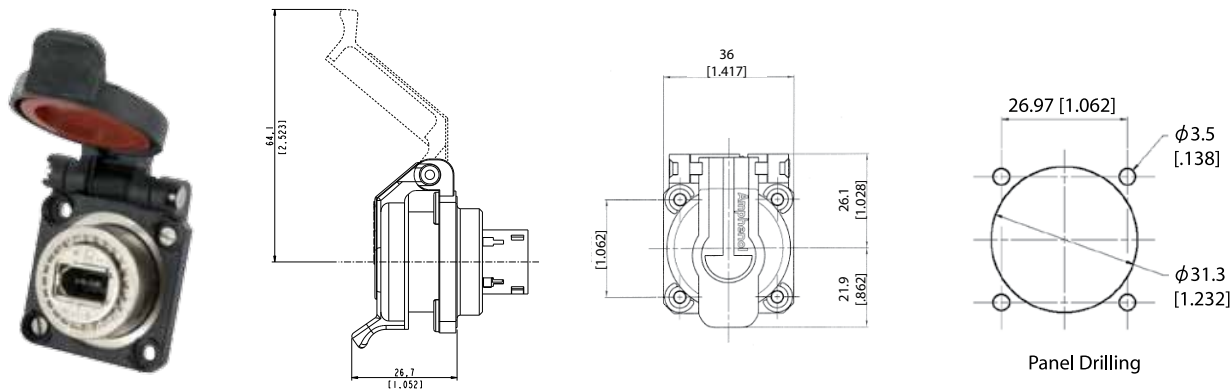

Version IEEE1394

Part number	Plating		Metallized inserts (EMI)	
	FWF 21B SCC	FWF 21N SCC	FWF 21G SCC	
	Black coated	Nickel plated	Olive drab cadmium plated	No (blank insert)
				Yes
				Yes

■ **Note:** Panel gasket with any of these receptacles: JE18



RJF 21 X SCC, USBF 21 X SCC, USBBF 21 X SCC



RJ45 version
(see page 23)



USB-A version
(see page 83)



USB-B version
(see page 92)