

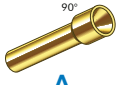

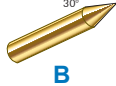





► **S-3 SERIES**

0.125 (3.18) Centers

For R-3 Series Receptacles see pg. 66

STEEL TIPS	DIAMETER
 A	0.100 (2.54)
 B	0.067 (1.70)
 C	0.067 (1.70)
 E	0.100 (2.54)
 F	0.100 (2.54)
 G	0.067 (1.70)
 H	0.100 (2.54)
 J	0.067 (1.70)
 K	0.100 (2.54)

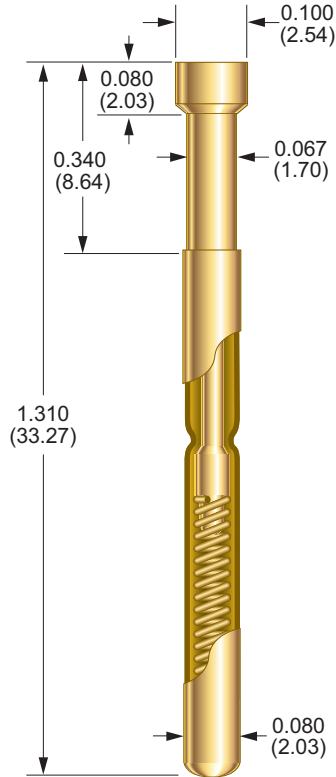

PROBE SPECIFICATIONS

Minimum Centers	0.125 (3.18)
Current Rating	5 A continuous
Spring Force	4.00 oz (113 g) or 7.00 oz (198 g) @ 0.170 (4.32) travel
Preload Force	1.80 oz (51 g) (4.00 oz spring) 2.90 oz (82 g) (7.00 oz spring)
Typical Resistance	< 20 mΩ
Maximum Travel	0.250 (6.35)
Working Travel	0.170 (4.32)

MATERIALS

Barrel	Nickel/silver, gold plated
Spring	Stainless steel, gold plated
Plunger	Beryllium copper, gold plated over nickel, or Duralloy™

HOW TO ORDER

S - 3 - A - 4 - G	
1 2 3 4 5	
1 ► SERIES	S
2 ► SIZE	3
3 ► TIP STYLE	A, B, C, E, F, G, H, J, K
4 ► SPRING FORCE	4 oz. 7 oz.
5 ► PLUNGER PLATING	G GOLD D DURALLOY™