

Self Powered Engine Digital Tach/ Maintenance/Hour Meter, Series PT14



PT14

Features

- Large 7 segment LCD display
- Low cost and small size
- No Power required
- Solid state electronics
- Quartz Crystal
- Wide operating temperature range
- High reliability
- Standard is Resettable, non reset version is available from factory
- Indicates operation in RPMs and Hours
- Self programmable or factory set 1, 2, 4, Cycle engine, or Hour Meter only
- Easy to install
- Made in the U.S.A.

ENM is proud to present the new series PT14 self-powered Digital Tach/Maintenance/Hour meter. The PT14 keeps track of true engine RPM and running time for all types of gasoline engines. The unit is powered by an internal lithium battery. No external power connections are required.

The operation of the Tach/Hour meter is triggered by 5.5 ft. shielded and external lead, wrapped around the spark plug wire of the engine. Since the unit is triggered by the spark of the engine, the hours and the RPM display actual operation. This is useful for maintenance and warranty applications for any type of engine-powered machinery.

When the engine is on, the display will read the RPM of the engine. When the engine is off, the display will switch to run time and remains visible.

With solid state technology the PT14 series is built with a custom chip and with solid construction for maximum durability in harsh environments and rugged application.

Specifications

Capacity:	9999.9 Hours Meter 9999.9 Maintenance/Hours 01=13,000 RPM 02=24,000 RPM 03=48,000 RPM
Sampling Time:	1-Second Approximate
Character height:	Large 8 mm digits.
Operating battery life:	Internal lithium battery 35,000 hours continuous running.
Operating temperature:	Standard -10C to +60C Special -40 C to + 85 C
Vibration resistance:	Withstands 10 to 75 Hz. at 1 to 8 G's.
Rpm Resolution:	10 Rpm
Configuration:	Two hole base mount.

2004 ENM Co.®

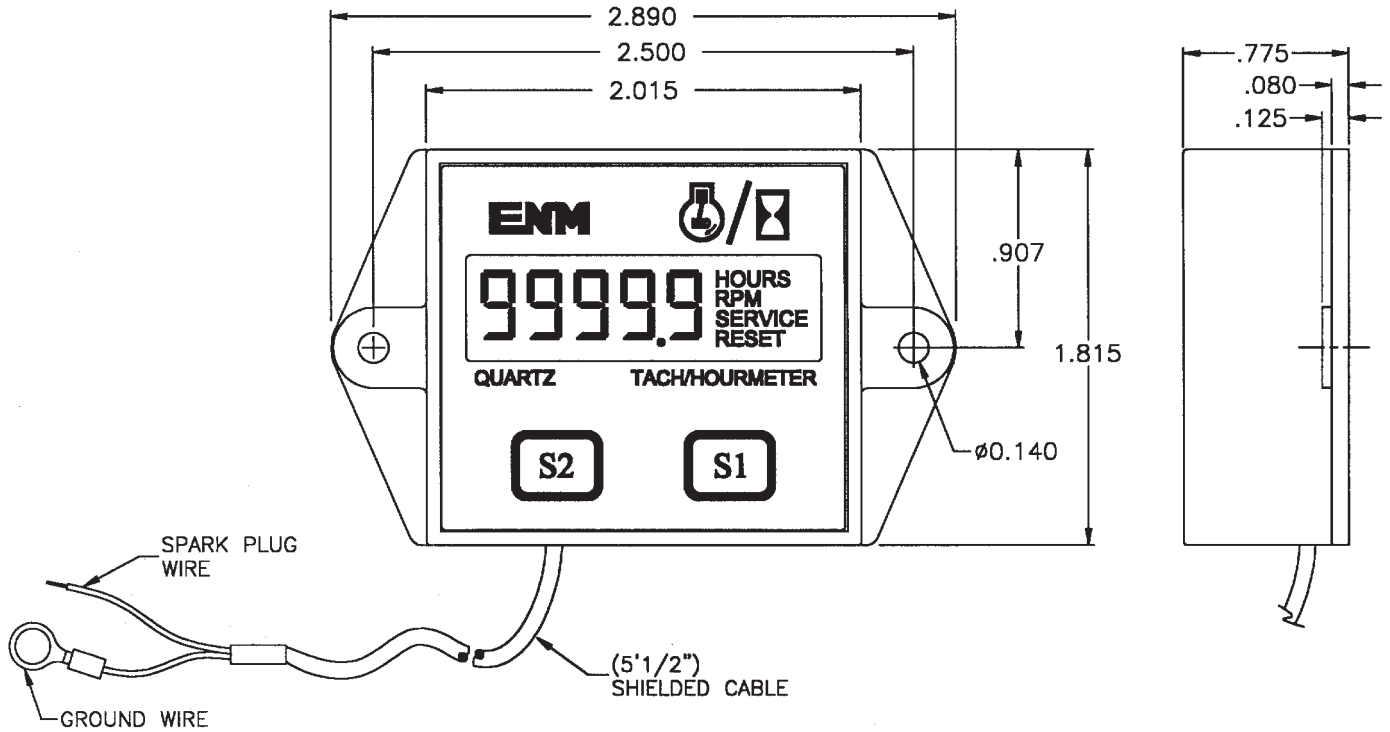

PT14 Engine Firing Pattern

- 01 This setting is used when there is a spark plug firing twice per revolution
- 02 This setting is used when there is a spark once per revolution.
- 03 This setting is used when there is a spark once per two revolutions.

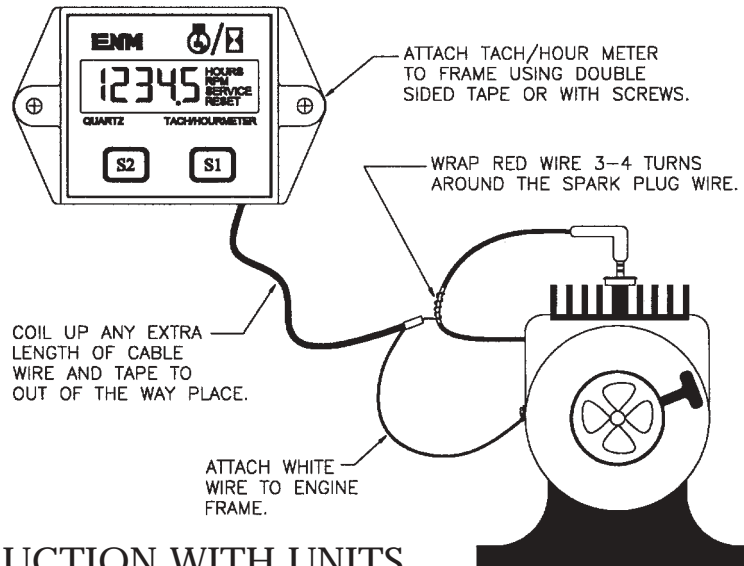

S1 & S2 PROGRAMMING INSTRUCTION WITH UNITS

2004 ENM Co.®

LIMITED WARRANTY HOUR METERS

ENM Company hour meters are warranted to the consumer to be free from defects in material and workmanship for a period of 10,000 operating hours or for a period of 3 years, whichever first occurs. All ENM products which fall within the warranty period due to defects in material or workmanship will be repaired or replaced, at ENM's option, without charge to the consumer when returned with proof of purchase to any authorized ENM dealer in the United States, transportation charges prepaid, provided there is no evidence of improper installation, tampering, or other abuse. All implied warranties, including any implied warranty of merchantability or fitness for a particular purpose, shall be limited in duration to the express warranty period specified above. ENM disclaims any liability for consequential damages due to breach of any written or implied warranty on its hour meter. Datasheet information subject to change.

INSTRUCTIONS

ENM Company's New ENGINE MONITOR PT 14 SERIES

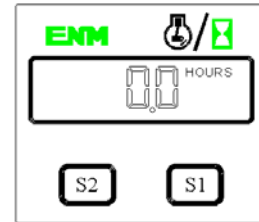

1 Introduction

The ENGINE MONITOR is a self powered LCD Hour meter, Tachometer and Maintenance Meter. An internal lithium battery furnishes the power for the monitor. A wire around the spark plug wire of the engine provides both a tachometer signal and an indicator that the engine is running. The maintenance meter is used to alert maintenance personnel that a time interval has expired and maintenance should be performed on the engine.

Before changing any settings to the ENGINE MONITOR, ensure that the engine is off.

2 Installation

Unpack and attach the unit to a location where it can be easily read. Uncoil the shielded wire and wrap 3 or 4 turns of the red wire around the engine's spark plug wire. The white wire must be attached to the engine's frame. The LCD will display the accumulated hours on the hour meter and a **HOURS** icon.

3 TO SET THE TACHOMETER (SPARK PLUG FIRING REVOLUTION)

Press and hold the **S1** button for 4 seconds. The LCD will display **01** (spark plug fires twice per revolution), **02** (once per revolution), **03** (every other revolution), **04** (hours only, will not display RPM). Once you find your desired spark plug firing pattern, release the **S1** button. The LCD will blink for 8 to 10 seconds and return to total hour meter mode. The default for the standard model is **02** (once per revolution). This default can be changed during manufacturing.

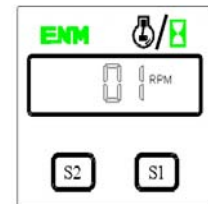

4 TO SET THE MAINTENANCE INTERVAL TIMER

Press and hold down the **S2** button for 4 seconds. The right most digit on the LCD will flash and the **SERVICE** icon will be displayed. Pressing and holding the **S1** button will cause the flashing digit to automatically increment. When the desired number has been reached release the **S1** button and press the **S2** button for 1 second to increment to the next digit. Repeat above steps until the service time interval has been entered. After 14 to 16 seconds with no buttons pressed, the LCD display will return to total hours mode.

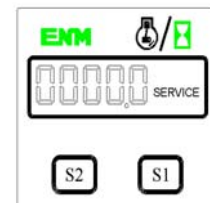

INSTRUCTIONS

5 ACTIVATING THE MAINTENANCE INTERVAL TIMER

Press and hold the **S1** and **S2** button simultaneously for 4 seconds. The two digits will increment to 20 seconds and then return to total hours mode. When the engine is running and the maintenance time has reached zero, the service icon will come on.

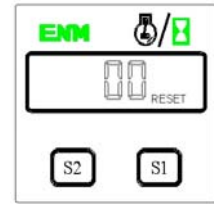

6 VIEWING MAINTENANCE INTERVAL

Press and hold the **S2** button for 4 seconds to view remaining time of your maintenance interval. To continue current maintenance do nothing. If you would like to start a new maintenance interval, repeat steps 4 & 5 again. Each time you want to view the remaining time of your maintenance, press and hold **S2**.

7 RESETTING THE SERVICE ICON

Press and hold the **S1** and **S2** buttons for 20 seconds. The service icon will shut off. The maintenance time will automatically default to the number previously programmed.

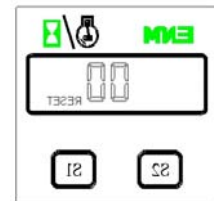

8 TO DISPLAY HOURS ONLY

Press and hold the **S1** button until **04** is displayed. Release the **S1** button and the display returns to total hours after 8 to 10 seconds. When the engine is running the display will show hours only, no RPM and the Hour Icon will blink.

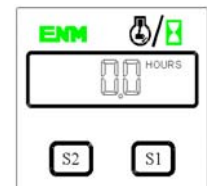

9 TO RESET TOTAL HOURS AND MAINTENANCE TIME

Press and hold the **S1** button until **05** is displayed. Release the **S1** button and after 8 seconds the display will return to total hours. Press and hold **S1** and **S2** simultaneously for 20 seconds and the meter will perform a total reset. The total reset option can be removed during manufacture.

