

Technical Information

Field Xpert SMT77

Universal, high-performance tablet PC for device configuration in Ex Zone 1 areas



Application

The Field Xpert SMT77 for device configuration enables mobile plant asset management in areas categorized as Ex Zone 1. It is suitable for commissioning and maintenance staff to easily manage field instruments with a digital, wired and wireless communication interface. The touch-enabled tablet PC is designed as a complete solution. It comes with comprehensive pre-installed driver libraries and offers users a modern software user interface to manage field instruments throughout the entire life cycle.

The integrated LTE Modul ensures that the tablet is online even if Wi-Fi is not available.

Your benefits

- High-performance, robust tablet for use in Ex Zone 1 areas with a large 10.1" display and a battery runtime of up to 5 hours.
- Touch-enabled device configuration software for optimized asset management.
- Direct link to Netilion, Endress+Hauser's IIoT ecosystem.
- Pre-installed device driver libraries for all of the important industrial protocols.
- Fast connection to devices with a single click thanks to automatic hardware detection, online application software and DTM/driver update service offer new functionality and maximum security.
- Integrated Heartbeat Verification incl. PDF documentation.
- Connection to Endress+Hauser Bluetooth and WLAN devices - perfect for difficult-to-access instruments.

Table of contents

About this document	3
Symbols used	3
Function and system design	3
HART point-to-point connection via Commubox FXA195 ...	5
Connection via WLAN and Bluetooth	5
HART point-to-point communication via FieldPort SFP50 ...	6
CDI point-to-point connection	6
PROFIBUS point-to-bus connection	6
Communication and data processing	7
Power supply	7
Supply voltage	7
Battery	7
Performance characteristics	8
Hardware	8
Software	8
Environment	9
Ambient temperature range	9
Storage temperature	10
Humidity	10
Operating height	10
Degree of protection	10
Vibration resistance	10
Shock resistance	10
Electromagnetic compatibility (EMC)	10
Mechanical construction	10
Design, dimensions	10
Weight	11
Display and user interface	11
Operating concept	11
Languages	11
Certificates and approvals	11
Ordering information	11
Scope of delivery	12
Accessories	12
Documentation	12
Standard documentation	12
Registered trademarks	12

About this document

Symbols used

Safety symbols

DANGER

This symbol alerts you to a dangerous situation. Failure to avoid this situation will result in serious or fatal injury.

WARNING

This symbol alerts you to a dangerous situation. Failure to avoid this situation can result in serious or fatal injury.









CAUTION

This symbol alerts you to a dangerous situation. Failure to avoid this situation can result in minor or medium injury.

NOTICE

This symbol contains information on procedures and other facts which do not result in personal injury.

Symbols for certain types of information

Symbol	Meaning
	Permitted Procedures, processes or actions that are permitted.
	Preferred Procedures, processes or actions that are preferred.
	Forbidden Procedures, processes or actions that are forbidden.
	Tip Indicates additional information.
	Reference to documentation
	Reference to page
	Reference to graphic
	Visual inspection

Function and system design

The Field Xpert SMT77 tablet PC for universal device configuration supports a variety of protocols, the Endress+Hauser service protocols, and connection to Endress+Hauser Bluetooth field devices. The field devices can be connected directly via a suitable interface, such as a modem (point-to-point), a bus system (point-to-bus) or a wireless connection (WLAN/Bluetooth). The Field Xpert software package is fast, easy and intuitive to use. The Field Xpert device library has more than 2,700 pre-installed device and communication drivers. They can be used to operate practically all HART and FOUNDATION Fieldbus devices (FieldComm Group libraries). Furthermore all Endress+Hauser field device drivers are installed. Further device drivers (DTMs) can be installed additionally. The generic HART DTM and PROFIBUS profile DTMs also enable operation of all the important basic functionalities of the relevant field devices.

Supported field devices and protocols

Endress+Hauser field devices and 3rd-party field devices

- HART
- PROFIBUS DP/PA
- FOUNDATION Fieldbus
- Modbus
- IO-Link

Endress+Hauser service protocols

- CDI
- ISS
- IPC
- PCP

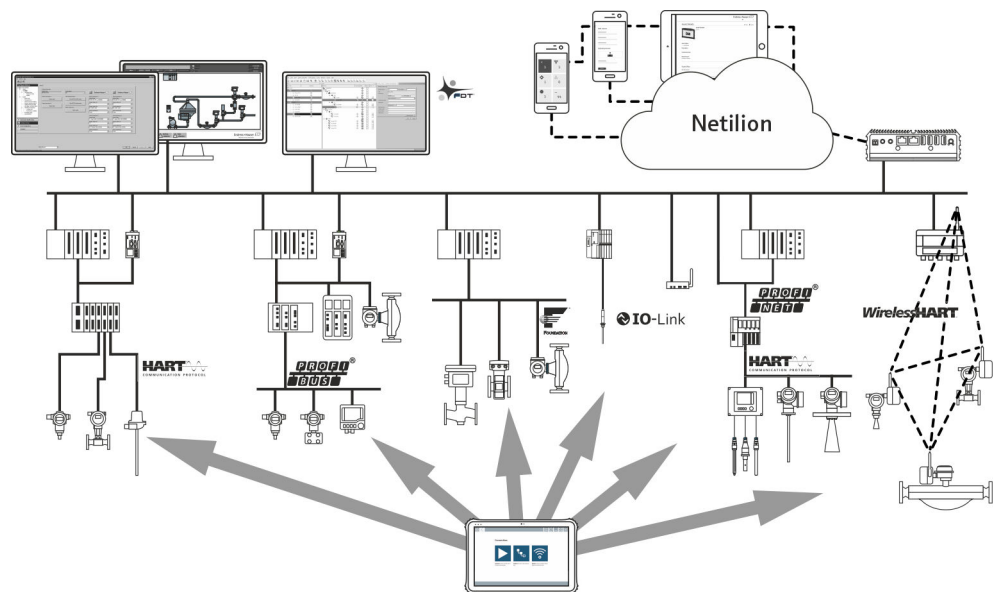

1 Network architecture

The following communication methods are supported by the Field Xpert SMT tablet PC:

Communication	Interface/modem/gateway	Use in non-hazardous zone permitted?	Use in hazardous zone permitted?
HART	Commubox FXA195 (4 to 20 mA)	Yes	No
	MACTek Bluetooth modem (4 to 20 mA)	Yes	Yes
	Memograph RSG45 (4 to 20 mA)	Yes	No
	MACTek USB modem (4 to 20 mA)	Yes	No
	FieldPort SFP50	Yes	Yes
	Fieldgate SFG250	Not applicable	Not applicable
	Tank Scanner NXA820	Not applicable	Not applicable
	BARTEC add-on module	Yes	Yes
PROFIBUS	Softing PROFusb	Yes	No
	Softing PBpro USB	Yes	No
	FieldPort SFP50	Yes	Yes
	Fieldgate SFG500	Not applicable	Not applicable
FOUNDATION Fieldbus	NI USB	Yes	No
	Softing FFusb	Yes	No
	FieldPort SFP50	Yes	Yes
Bluetooth		Yes	Yes
Modbus	Modbus serial	Yes	No
WirelessHART	Wireless HART adapter SWA70	Yes	Yes
	WirelessHART Fieldgate SWG70	Yes	Yes
Endress+Hauser service interfaces	Commubox FXA291	Yes	No
	Commubox FXA193	Yes	No

Communication	Interface/modem/gateway	Use in non-hazardous zone permitted?	Use in hazardous zone permitted?
	TXU10 V2	Yes	No
	TXU10 V1	Yes	No
	CDI USB	Yes	No
	CDI TCP/IP	Yes	Yes
IO-Link	FieldPort SFP20	Yes	No

HART point-to-point connection via Commubox FXA195

This diagram shows a HART point-to-point connection with an FXA195 USB/HART modem. If an FXA195 is connected to the computer, the Field Xpert SMT77 tablet PC can connect to the device automatically.

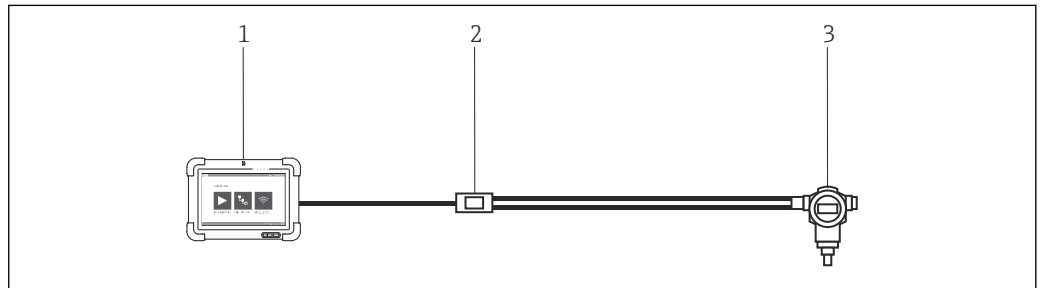

2 Point-to-point connection with a HART field device

- 1 Field Xpert SMT77 tablet PC
- 2 HART Commubox FXA195
- 3 Field device

To establish communication with the HART device, a resistor of at least 250 Ω must be provided in the circuit. The way in which this is done depends upon the system architecture and power source used. Please read the FXA195 manual carefully.

Connection via WLAN and Bluetooth

This diagram shows how to establish a connection to a WLAN-enabled or Bluetooth-enabled Endress+Hauser device.

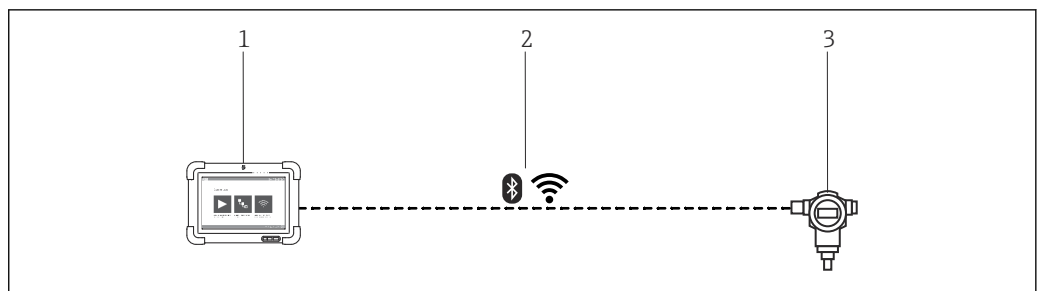

3 Connection via WLAN and Bluetooth

- 1 Field Xpert SMT77 tablet PC
- 2 WLAN or Bluetooth
- 3 Field device

HART point-to-point communication via FieldPort SFP50

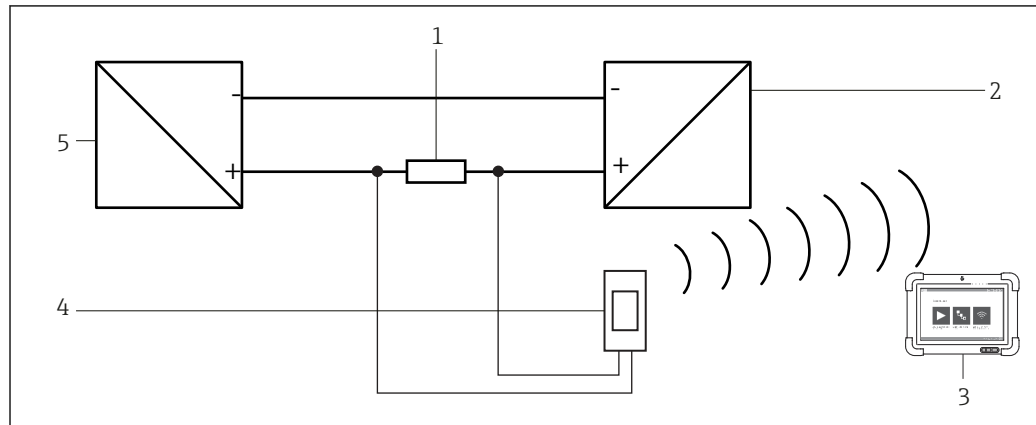

4 Point-to-point connection via a load resistor

- 1 Load resistor: 250 to 1 100 Ω
- 2 HART device
- 3 Field Xpert SMT77 tablet PC
- 4 FieldPort SFP50
- 5 Transmitter power supply unit

CDI point-to-point connection

This diagram shows a CDI point-to-point connection with a Commubox FXA291 interface. If this Commubox is connected to the computer, the Field Xpert SMT77 tablet PC can connect to the device automatically.

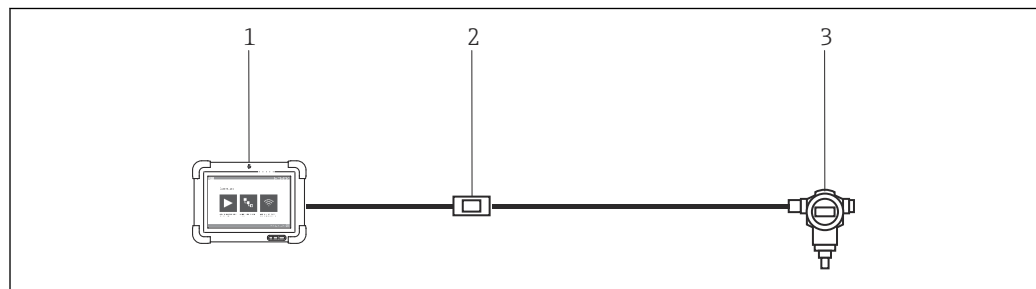

5 CDI point-to-point connection with a field device

- 1 Field Xpert SMT77 tablet PC
- 2 Commubox FXA291 CDI
- 3 Field device with CDI interface

PROFIBUS point-to-bus connection

This diagram shows how the connection from PROFIBUS DP to PROFIBUS PA can be established using a Siemens DP/PA Link or a Pepperl+Fuchs SK3.

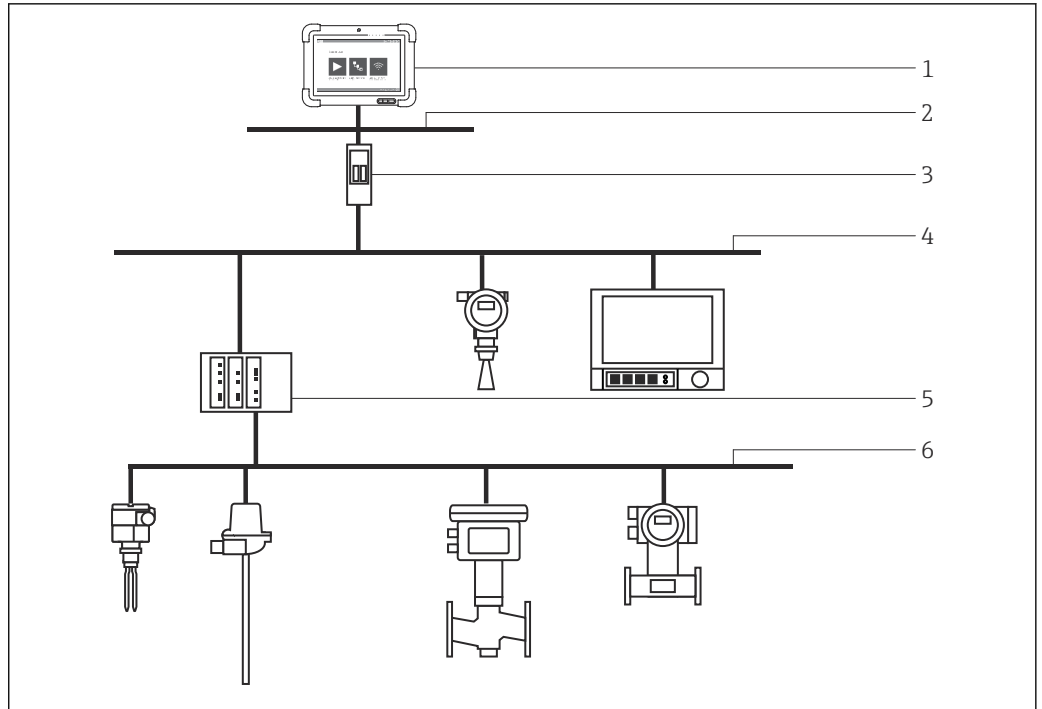

6 PROFIBUS point-to-bus connection via Fieldgate SFG500

- 1 Field Xpert SMT77 tablet PC
- 2 Ethernet
- 3 Fieldgate SFG500
- 4 PROFIBUS DP
- 5 Segment coupler
- 6 PROFIBUS PA

Communication and data processing

USB	USB 2.0
Wireless LAN	IEEE 802.11 a/b/g/n/ac 2 antennas
Bluetooth	Bluetooth 4.1 LE, Class I
Wireless WAN	4G/LTE WWAN (optional)

Power supply

Supply voltage

Voltage	19 V
Current	3.42 A
Power	65 W

Battery

Replaceable, rechargeable lithium polymer battery

Type	Internal	External
Voltage	7.4 V	7.4 V
Power	4 200 mAh	4 200 mAh
Battery life	Up to 3 h	Internal and external battery up to 5 h  The external battery can be hot-swapped during operation in hazardous areas.

Performance characteristics

Hardware	CPU	Intel N3710 1.6 GHz or better (turbo 2.56 GHz)
	Working memory	8 GB SODIM DDR3L-1600
	Memory	128 GB SATA uSSD
	Display	10.1" (1920 x 1200) LCD display, 2x bonded Gorilla Glass 10 points multi-touch Brightness 700cd/m ² Contrast ratio 800:1 LED background lighting Viewing angle of 89° from all sides
	LED display	Operational display Charging indicator Mass storage status Radio connection status
	Keys	On/off Volume Home/menu Touch button for barcode/camera Programmable touch button
	Audio	2 microphones with integrated noise cancellation 2 speakers (2 x 0.5 W)
	Scanner	1D/2D barcode scanner (optional)
	RFID	RFID reader HF/NFC
	Camera	2 MP camera on the front 5 MP camera or better on the back with auto focus and flash
	Connections	MicroSD card slot Micro SIM card slot Charging port Docking port
	Connection to docking station	4x USB 2.0 RS232 Ethernet 10/100 Mbit/s 1x HDMI Charging port
	Expansion port	HART add-on module

Software	Operating system	Windows 10 SAC
	Configured software	Touch-enabled device configuration software optimized for Field Xpert
	Standard software	Standard configurable Windows user interface with icons, shortcuts, etc.

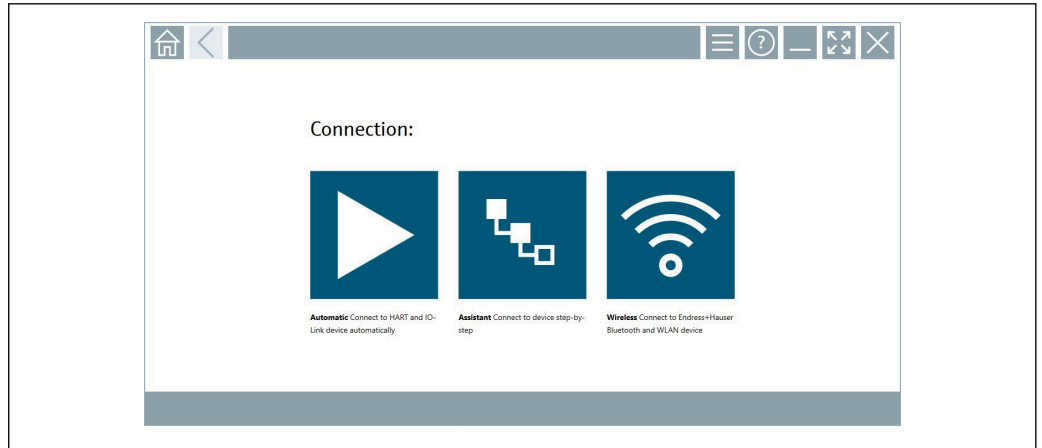

A0048390

7 Start screen with one-click automatic scan button

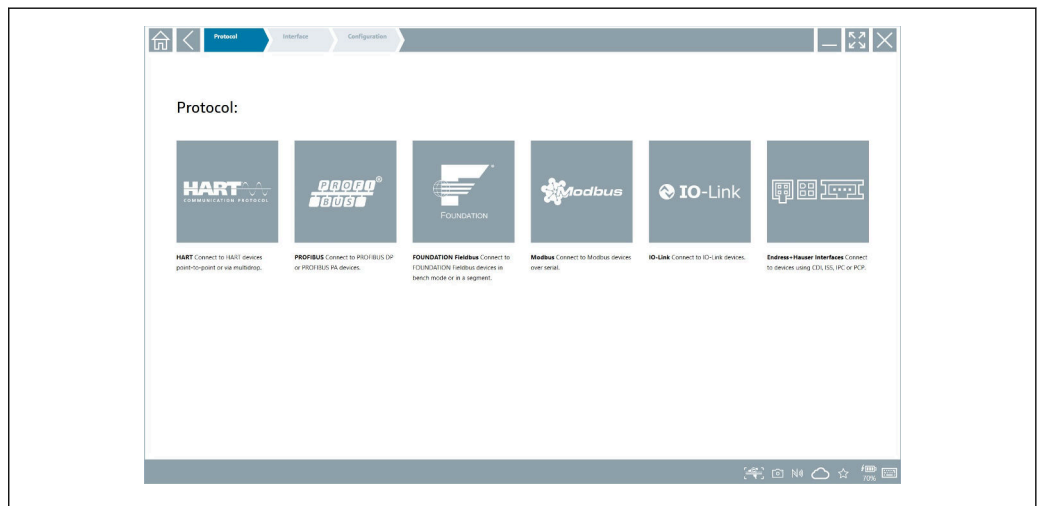

A0048391

8 Protocol selection for manual selection of connection

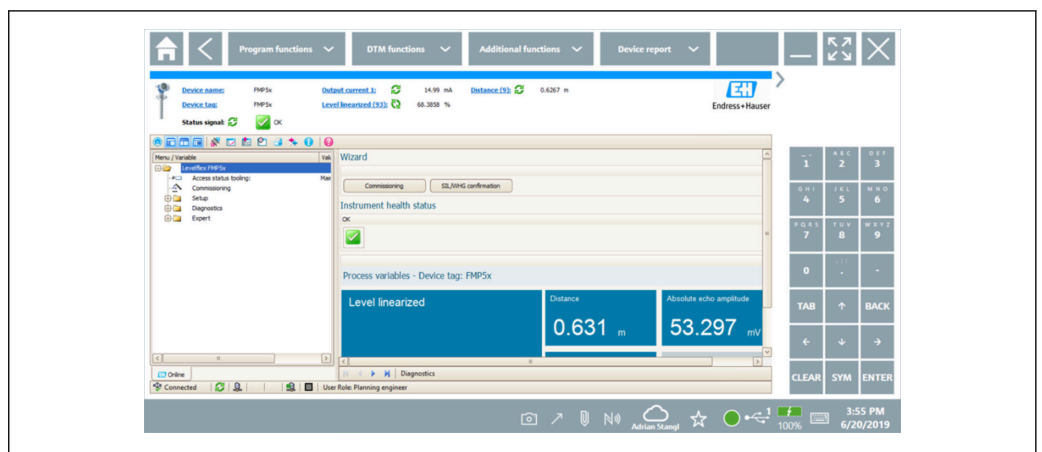

A0048392

9 Device configuration

Environment

Ambient temperature range -20 to 50 °C (-4 to 122 °F) (without cold start)

Storage temperature	-20 to 50 °C (-4 to 122 °F)
Humidity	5 to 95 % (non-condensing)
Operating height	
Degree of protection	IP65 (EN/IEC 60529)
Vibration resistance	
Shock resistance	Can withstand a drop of over 1 m onto concrete (incl. add-on module and battery)
Electromagnetic compatibility (EMC)	

Mechanical construction

Design, dimensions	290 mm · 209 mm · 33 mm (11.42 in · 8.23 in · 1.3 in)
--------------------	---

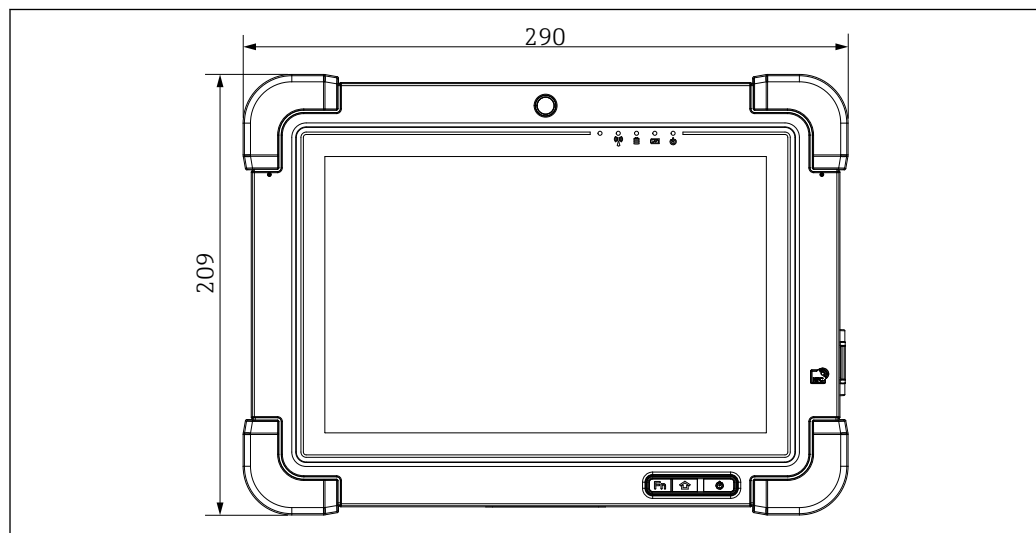

A0037499

10 Front view

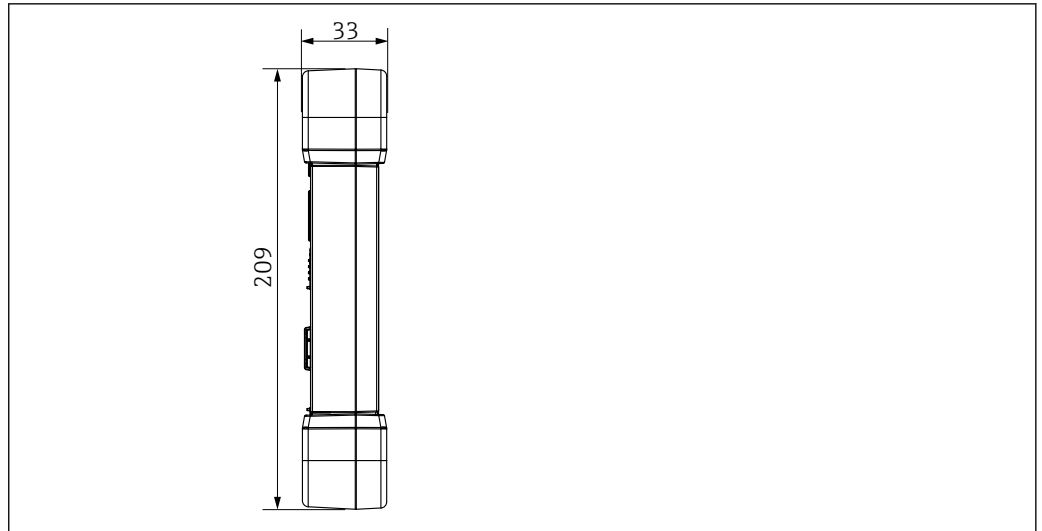

11 Side view

A0037958

Weight 2.3 kg (5.1 lb)

Display and user interface

Operating concept Automatic connection to field devices or via wizard
DTM user interface and language depend on the field device and manufacturer

Languages Choice of languages within the Field Xpert software: AR, CS, DE, ES, FI, FR, ID, IT, JA, KO, NL, PL, PT, RU, EN, SV, TH, TR, VI, ZH

Certificates and approvals

The latest approvals for the product are available from www.endress.com:

1. Select the product using the filters and search field.
2. Open the product page.
3. Select **Downloads**.
 - ↳ A list of all approvals and declarations appears.

Ordering information

Detailed ordering information is available from your nearest sales organization www.addresses.endress.com or in the Product Configurator at www.endress.com:

1. Select the product using the filters and search field.
2. Open the product page.
3. Select **Configuration**.



Product Configurator - the tool for individual product configuration

- Up-to-the-minute configuration data
- Depending on the device: Direct input of measuring point-specific information such as measuring range or operating language
- Automatic verification of exclusion criteria
- Automatic creation of the order code and its breakdown in PDF or Excel output format
- Ability to order directly in the Endress+Hauser Online Shop

Scope of delivery

The scope of delivery comprises:

- Field Xpert SMT77 tablet PC
- AC charger (100 to 240 V_{AC}, 1.5 A, 50 to 60 Hz) with connecting cable EU, US, UK, CH, IT, ZA, AU
- Software and interfaces/modem as per order

Accessories

The accessories currently available for the product can be selected at www.endress.com:

1. Select the product using the filters and search field.
2. Open the product page.
3. Select **Spare parts & Accessories**.

Documentation

Standard documentation

- Field Xpert SMT77 Operating Instructions BA01923S/04/EN
- Field Xpert SMT77 Innovation Brochure IN01136S/04/EN

Registered trademarks

Windows 10 IoT Enterprise® is a registered trademark of Microsoft Corporation, Redmond, Washington, USA.

Intel® Core™ is a registered trademark of Intel Corporation, Santa Clara, USA.

BARTEC Agile X IS is a registered trademark of BARTEC Top Holding GmbH, Bad Mergetheim/Germany.

FOUNDATION™ Fieldbus is the trademark of the FieldComm Group, Austin, TX 78759, USA.

HART®, WirelessHART® is the registered trademark of the FieldComm Group, Austin, TX 78759, USA.

PROFIBUS® is a registered trademark of the PROFIBUS User Organization, Karlsruhe/Germany.

Modbus is the registered trademark of Modicon, Incorporated.

IO-Link® is a registered trademark of the IO-Link Community c/o PROFIBUS User Organization, (PNO) Karlsruhe/ Germany - www.io-link.com

All other brand and product names are trademarks or registered trademarks of the companies and organizations in question.





71591616

www.addresses.endress.com
