



ENGLISH

Datasheet

Article No: 136-5377

Digital Multi-Function Meter, 96x96, 3Ph, V A F

Article No: 136-5378

Digital Multi-Function Meter, 96x96, 3Ph, V A F, with Limit Relay/Switch option

RS Pro





RS Pro

- True RMS Measurement
- Onsite Programmable
- Limit Switch Output
- Low Back Depth
- 3 Line Ultra Bright LED Display
- Run Hour / On Hour indication

RS Pro measures important electrical parameters in 3 phase 4 Wire, 3 phase 3 Wire and 1 phase Network & replaces the multiple analog panel meters. It measures electrical parameters like AC Voltage, AC Current, Frequency & many more. The instrument also has an optional limit switch.

Applications:

- Distribution Panels
- Electrical load monitoring
- Genset, Test Benches and Laboratories
- Motor Control Panels

Product Features

True RMS measurement

Measures distorted waveform up to 15th Harmonic.

Onsite programmable

Onsite Programmable System Configuration 3PH4W / 3PH3W and Single phase. Onsite Programmable CT ratios and PT ratios

Limit Switch (Optional)

Potential free, very fast acting relay contact configurable as limit (alarm) switch. The instrument will trip the relay if the programmed parameter exceeds the programmed Trip Limits.

3 line 3 digits Ultra Bright LED display

Simultaneous display of 3 different parameters.

Run Hour, ON Hour, Number of Interruptions

Run Hour records the number of hours load is connected. ON Hour is the period for which the auxiliary supply is ON. Number of Interruptions indicates the number of times the Auxiliary Supply was interrupted.



RPM Measurement

The instrument display Rotation per minutes for generator applications. Number of poles can be set on site depending upon application requirement.

Storage of Parameters possible

The instrument stores minimum and maximum values for System Voltage, System Current, Run Hour, ON Hour & number of Interrupts. Every 60 sec stored values are updated.

Low Back Depth

The instrument has very low back depth (behind the panel) of less than 55 mm.

Parameter Screen recall

In case of power failure, the instrument memorizes the last displayed screen.

Onsite selection of Auto scroll / Fixed Screen

User can set the display in auto scrolling mode or fixed screen mode locally via front panel keys by entering into Programming mode.

Enclosure Protection for dust and water

Conforms to IP 54 (front face) as per IEC60529

Compliance to International Safety standards

Compliance to International Safety standard IEC 61010-1- 2010

EMC Compatibility

Compliance to International standard IEC 61326



Technical Specifications

Input Voltage:	
Nominal input voltage (AC RMS)	100 VL-L - 500 VL-L (57.7 VL-N - 290VL-N)
System PT primary values	100 VLL to 799 kVLL programmable on site.
System PT secondary values	100 VLL to 500 VLL programmable on site.
Max continuous input voltage	120% of Nominal value
Input Current:	
Nominal input current	1A / 5A AC RMS
System CT primary values	From 1A up to 799 kA programmable on site.
System CT secondary values	1A / 5A Programmable at site.
Max continuous input current	120% of Nominal value
Auxiliary Supply:	
External Aux	40 V - 300V AC-DC ($\pm 5\%$) or 20 V - 40V AC / 20 V - 60V DC
Aux supply frequency	45 to 65 Hz range
VA Burden:	
Nominal input voltage burden	< 0.3 VA approx. per phase
Nominal input current burden	< 0.2 VA approx. per phase
Auxiliary Supply burden	< 4 VA approx
Operating Measuring Ranges:	
Current	5... 120% of Nominal value
Voltage	10... 120% of Nominal value
Frequency	45 - 65 Hz
Reference Condition for Accuracy:	
Reference Temperature	23°C \pm 2°C
Input Frequency	50/60 Hz \pm 2%
Current	10... 100% of Nominal value
Voltage	20... 100% of Nominal value
Auxiliary Supply Voltage	Nominal Value \pm 1%
Auxiliary Supply Frequency	Nominal Value \pm 1%
Accuracy:	
Voltage	\pm 1.0% of Nominal Value
Current	\pm 1.0% of Nominal Value
Frequency	\pm 0.5% of Mid Frequency

Dimension Details

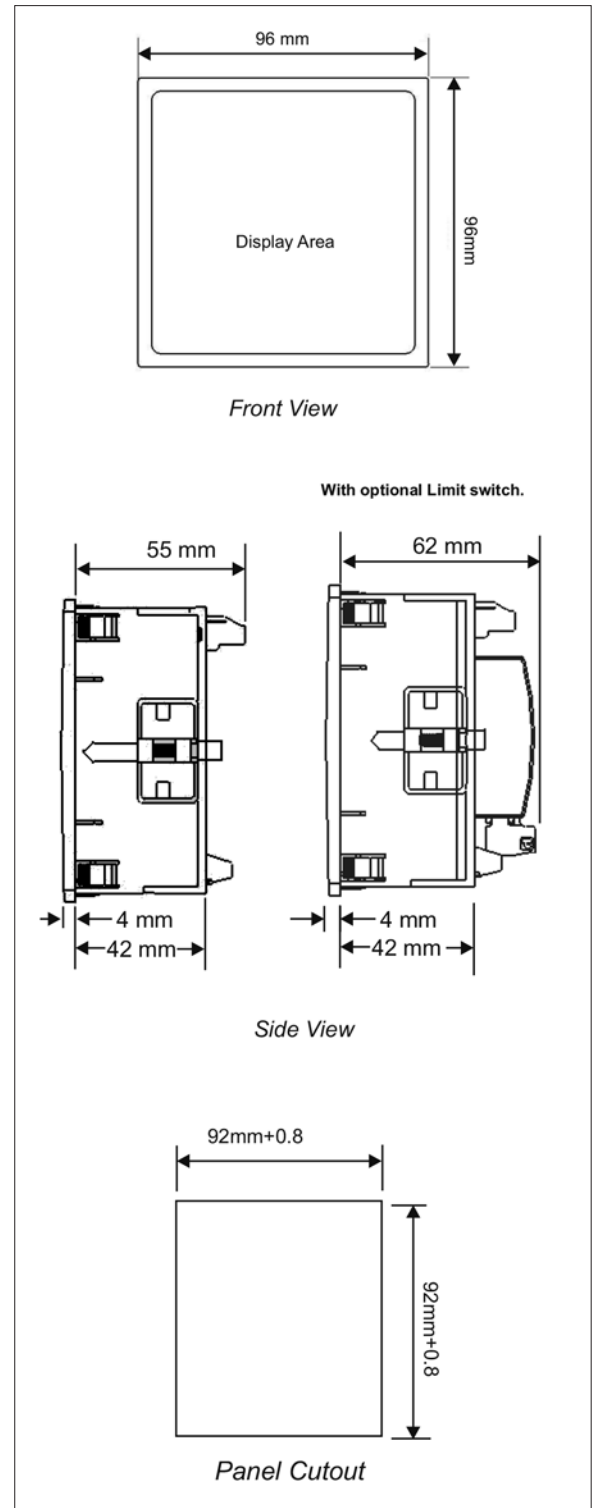



Technical Specifications

Overload Withstand:	
Voltage	2 x Nominal value for 1 second, repeated 10 times at 10 second intervals
Current	20x Nominal value for 1 second, repeated 5 times at 5 min intervals
Influence of Variations:	
Temperature coefficient	0.05%/°C
Display update rate:	
Response time to step input	1 sec approx.
Applicable Standards:	
EMC	IEC 61326
Immunity	IEC 61000-4-3. 10V/m min – Level 3 industrial Low level
Safety	IEC 61010-1-2010, Permanently connected use
IP for water & dust	IEC60529
Pollution degree	2
Installation category	III
High Voltage Test	3.3 kV AC, 50Hz for 1 minute between all Electrical circuits
Environmental	
Operating temperature	-10 to +55°C
Storage temperature	-20 to +65°C
Relative humidity	0... 90% non condensing
Warm up time	Minimum 3 minute
Shock	15g in 3 planes
Vibration 1	0... 150 ... 10 Hz, 0.15mm amplitude
Interfaces	
Relay(Optional)	240 VAC, 5 A Configured as Limit Switch

Installation

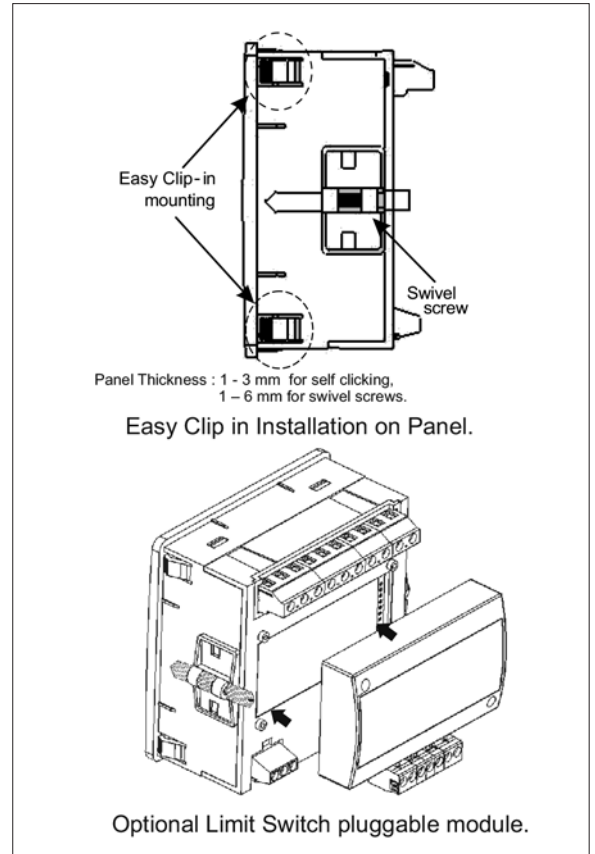

Electrical Connection

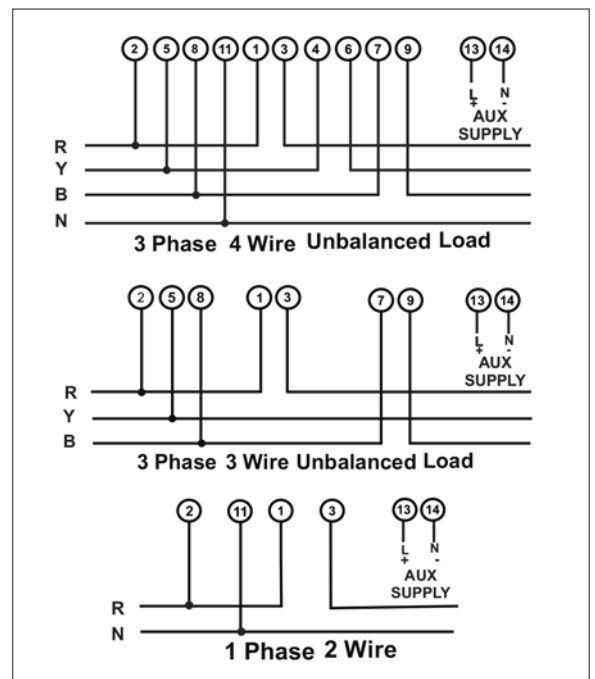



Display Parameter:

Sr No	Parameter	3 Phase 4 Wire	3 Phase 3 Wire	Single Phase 2W
1.	System Voltage	✓	✓	×
2.	Voltage R-N	✓	×	✓
3.	Voltage Y-N	✓	×	×
4.	Voltage B-N	✓	×	×
5.	Voltage R-Y	✓	✓	×
6.	Voltage Y-B	✓	✓	×
7.	Voltage B-R	✓	✓	×
8.	System Current	✓	✓	×
9.	Current R	✓	✓	✓
10.	Current Y	✓	✓	×
11.	Current B	✓	✓	×
12.	Frequency	✓	✓	✓
13.	RPM	✓	✓	✓
14.	Max (System Voltage / System Current)	✓	✓	✓
15.	Min (System Voltage / System Current)	✓	✓	✓
16.	Run Hour	✓	✓	✓
17.	On Hour	✓	✓	✓
18.	Number of Auxiliary Interruptions	✓	✓	✓

✓- Available ✗ - Not available

Ordering Information:

Article No : 136-5377

RS Pro Volts, Amps and Frequency, 96X96mm 3 Phase 3/4W programmable onsite,
 AC VAF meter, 14mm display,
 Input. 100-500VLL,
 Input. 1 or 5 Amps AC,
 Supply Voltage. 40-300V AC/DC auxiliary (Programmable CT/PT primary and secondary values)

Article No : 136-5378

RS Pro Volts, Amps and Frequency, 96X96mm 3 Phase 3/4W programmable onsite,
 AC VAF meter, 14mm display,
 Input. 100-500VLL,
 Input. 1 or 5 Amps AC,
 Supply Voltage. 40-300V AC/DC auxiliary (Programmable CT/PT primary and secondary values with Limit Switch/Relay O/P)



Every part matters

EN

Installation & Operating Instructions DIGITAL MULTI-FUNCTION INSTRUMENT Programmable Multi-function Digital Panel Meter

Article codes

136-5377 Digital Multi-Function Meter, 96x96, 3Ph, V A F
136-5378 Digital Multi-Function Meter, 96x96, 3Ph, V A F, with Limit Relay/Switch option

1. INTRODUCTION

The RS PRO is a panel mounted 96 x 96mm DIN Quadratic Digital Panel Meter for the measurement of important electrical parameters like AC Voltage, AC Current, RPM, Frequency.

The instrument integrates accurate measurement technology (All Voltages & current measurements are True RMS upto 15th Harmonic) with 3 line 3 digits Ultra high bright LED display.

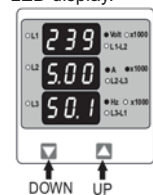

RS PRO can be configured and Programmed On site for the following : PT Primary, PT Secondary, CT Primary, CT Secondary (5A or 1A) and System Type 3 phase 3W or 4W or single phase system.

The front panel has two push buttons using which the user can scroll L3-L1 through different screens and configure the product.

2. MEASUREMENT READING SCREENS

In normal operation, the user is presented with one of the measurement reading screens out of several screens. These screens may be scrolled through one at a time in incremental order by pressing the "UP key" and in decremental order by pressing "DOWN key".

TABLE 1: Measured Parameters System Wise:

Measured Parameters	Units	3P 4W	3P 3W	1P 2W
System Voltage	Volts	✓	✓	✓
System Current	Amps	✓	✓	✓
Voltage VL1-N / VL2-N / VL3-N	Volts	✓	X	X
Voltage VL1-L2 / VL2-L3 / VL3-L1	Volts	✓	✓	X
Current L1 / L2 / L3	Volts	✓	✓	X
Frequency	Hz	✓	✓	✓
Run Hour	Hours	✓	✓	✓
On Hour	Hours	✓	✓	✓
Number of Interruptions	Counts	✓	✓	✓
Min / Max System Voltage	Volts	✓	✓	✓
Min / Max System Current	Amps	✓	✓	✓

3. Programming

The following sections comprise step by step procedures for configuring the RS PRO for individual user requirements. To access the set-up screens press and hold the "DOWN" and "UP" keys Simultaneously. This will take the User into the Password Entry screen (Section 3.1).

In Setup mode, if none of the key pressed within 1 min, it will return operation to the measurement mode.

3.1. Password Protection

Password protection can be enabled to prevent unauthorized access to set-up screens, by default password protection is not enabled.

Password protection is enabled by selecting a three digit number other than 000, setting a password of 000 disables the password protection.

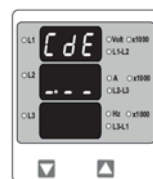

Enter Password, prompt for first digit.
(* Denotes that decimal point will be flashing).

Press the "DOWN" key to scroll the value of the first digit from 0 through to 9, the value will wrap from 9 round to 0.

Press the "UP" key to advance to next digit.

In the special case where the Password is "000" pressing the "UP" key when prompted for the first digit will advance to the "Password Confirmed" screen.

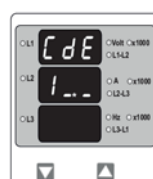

Enter Password, first digit entered, prompt for second digit.
(* Denotes that decimal point will be flashing).

Press the "DOWN" key to scroll the value of the second digit from 0 through to 9, the value will wrap from 9 round to 0.

Press the "UP" key to advance to next digit.



Enter Password, second digit entered, prompt for third digit.
(* Denotes that decimal point will be flashing).

Press the "DOWN" key to scroll the value of the third digit from 0 through to 9, the value will wrap from 9 round to 0.

Press the "UP" key to advance to password confirmation screen.

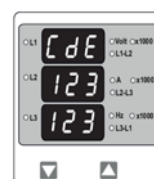

Enter Password, third digit entered, Awaiting verification of password.

Password confirmed.

Pressing "V" key will advance to the "New / change Password" entry stage.

Pressing the "UP" key will advance to the system type edit screen. (See section 3.2).

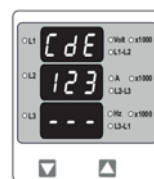

Password incorrect.

The unit has not accepted the Password entered.

Pressing the "DOWN" key will return to the Enter Password stage.

Pressing the "UP" key exits the Password menu and returns operation to the measurement reading mode.

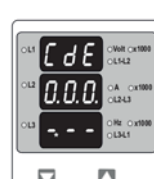

New / Change Password

(*Decimal point indicates that this will be flashing).

Pressing the "DOWN" key will scroll the value of the first Digit from 0 through to 9, the value will wrap from 9 round to 0.

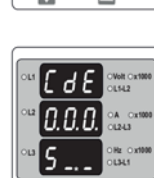

New / Change Password, first digit entered, prompting for second digit>(*Decimal point indicates that this will be flashing).

Pressing the "DOWN" key will scroll the value of second digit from 0 through to 9, the value will wrap from 9 round to 0.

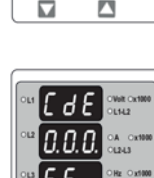

New / Change Password, second digit entered, prompting for third digit. (*decimal point indicates that this will be flashing).

Pressing the "DOWN" key will scroll the value of the third from 0 through to 9, the value will wrap from 9 round to 0.

Pressing the "UP" key to advance the operation to "New Password Confirmed" and sets the third digit, in this case to "7".

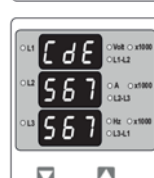

New Password confirmed.

Pressing the "DOWN" key will return to the "New/Change Password".

Pressing the "UP" key will advances to the Set up screen.(see section 3.2)

3.2 Set Up Screens

3.2.1. System Type

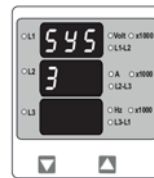

This screen is used to edit and set the system type. System type "3" for 3 phase 3 wire & "4" for 3 phase 4 wire & 1 for Single phase system.

Pressing "UP" key accepts present value and advances to the "Potential transformer Primary Value Edit" menu.

Pressing "DOWN" Key will enter the System type edit mode.

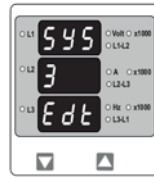

System Type Edit

This screen appears only if "DOWN" key is pressed in previous Menu.

Pressing "DOWN" scrolls through the values available.

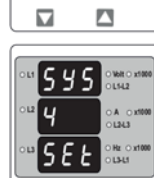

Pressing "UP" Key advances to the system type Confirmation menu.

System Type Confirmation

This screen will only appear following the edit of system type.

Pressing the "UP" key set the displayed value as system Type and will advance to "Potential Transformer Primary Value Edit" menu. (See section 3.2.2)

3.2.2. Potential Transformer Primary Value

The nominal full scale voltage which will be displayed as the Line to Line voltage for all system types. This screen enables the user to display Line to Line and Line to neutral Voltages inclusive of any PT ratios, the values displayed represent the voltage.

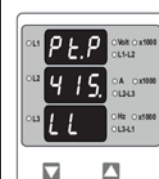

Pressing the "UP" key accepts the present value and advances to the "Current Transformer Primary value Edit" menu. (See Section 3.2.3)

Pressing the "DOWN" key will enter the "Potential transformer Primary value edit mode.

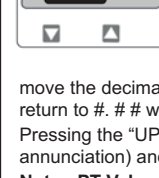

Initially the PT value must be selected pressing the "DOWN" key will move the decimal point position to the right side until it reaches # # #. after which it will return to # . # # with x1000 annunciation.

Pressing the "UP" key accepts the present multiplier (Decimal Point position with x1000 annunciation) and advances to the "Potential Transformer Primary Digit Edit" Screen.

Note : PT Values must be set as Line to Line Voltage for Primary as well as Secondary for all system types (3P3W/3P4W/1P2W).

Potential Transformer Primary Digit Edit

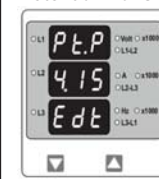

Pressing the "DOWN" key will scroll the value of the most significant digit from 0 to 9 unless the presently displayed Potential Transformer Primary value is less than 799 kilovolts in that case the digit range will be restricted.

Pressing the "UP" key accepts the present value at the cursor position and advances the cursor to the next Less significant digit.

Note : The flashing decimal point indicates the cursor position, a steady decimal point will be present to identify the scaling of the number until the cursor position coincides with the steady decimal point position. At this stage the decimal point will flash.

When the least significant digit has been set, pressing the "UP" key will advance to the "Potential transformer Primary Value Confirmation" stage.

Screen showing display of 11.0 k VL-L i.e. 11000 Volts Line to Line indicating steady decimal point and cursor flashing at the "hundreds of volts" position as shown below.

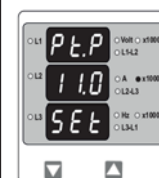

Potential Transformer Primary Value Confirmation

This screen will only appear following an edit of the Potential Transformer Primary Value.

If the set value is to be corrected, pressing the "DOWN" key will return to the "Potential Transformer Primary value Edit" stage.

Pressing the "UP" key sets the displayed value and will advance to the Current Transformer Primary Value. (See section 3.2.3.)

3.2.3. Current Transformer Primary Value

The nominal full Scale Current that will be displayed as the Line currents. This screen enables the user to display the Line currents inclusive of any current transformer ratios, the values displayed represent the Current in Amps or in kAmps when x1000 led is glows.

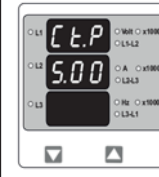

Pressing the "DOWN" key will enter the "Current Transformer Primary Value Edit" mode. Pressing the "UP" key will accept the present value And Advances to the "Potential Transformer Secondary Value edit screen (See section 3.2.4).

Further functionality is same as per Potential Transformer Primary Value (section 3.2.2).

3.2.4. Potential Transformer Secondary Value

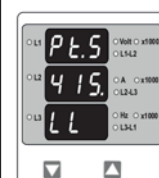

This screen is used to set the secondary value for Potential Transformer Secondary value from 100V to 500VL-L.

Pressing "UP" key accepts the present value and then advances to Current Transformer Secondary value edit mode.

Pressing the "DOWN" key will enter the PT secondary value edit mode. * Denotes that Decimal Point will be flashing.

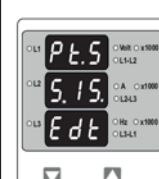

Potential Transformer secondary value Edit

Pressing "DOWN" Key advances the Most Significant Digit To scroll from 1 through 5 .Pressing "UP" Key shifts the Decimal Position to right.

When value of least significant Digit is set, Pressing of "UP" key advances the screen to "PT secondary value Confirmation" screen.

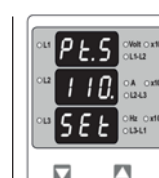

PT Secondary value confirmation.

This screen will only appears following an edit of PT secondary value.

If secondary value shown is not correct, pressing the "DOWN" key will return to PT secondary edit stage.

Pressing "UP" key sets the displayed value and will advance to CT Secondary Value Edit menu. (See section 3.2.5)

3.2.5. Current Transformer Secondary Value

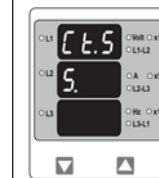

This screen is used to set the secondary value for Current Transformer Secondary value from 1 and 5 Amperes.

Pressing "UP" key accepts the present value and then advances to RESET menu..

Pressing the "DOWN" key will enter the CT secondary value edit mode.

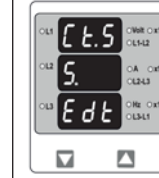

Current Transformer secondary value Edit

Pressing "DOWN" key scroll the value between 1 and 5.

Pressing "UP" key will enter the CT Secondary Value Confirmation menu.

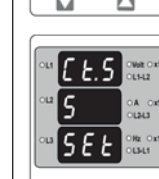

CT Secondary value confirmation.

This screen will only appears following an edit of CT secondary value.

If secondary value shown is not correct, pressing the "DOWN" key will return to CT secondary edit stage.

Pressing "UP" key sets the displayed value and will advance RESET menu (See section 3.2.5)

3.2.6. Reset

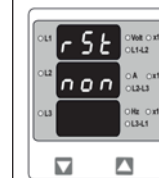

The following screens allow the users to reset the run hour, ON Hour, No. Of Interruptions, Min and Max. Values of Voltage and Current.

Pressing the "DOWN" key will enter the "Reset edit" menu.

Pressing the "UP" key will Reset None and enter to screen Auto of fixed selection menu.

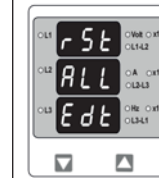

Edit the Reset of Parameters

Pressing "DOWN" will scroll the parameters in sequence as Follow :

1. All : To reset All parameters, 2. Hi : To reset Max values,
3. Lo : To reset min. Values, 4. Hr : To reset Run Hrs, On Hrs,
5. Int : To reset No. Of Interruptions,
6. None : No to reset any of the Parameters,

Select the Correct parameter to Reset and then Press "UP" key. This will enter to Reset Parameter Confirmation Screen.

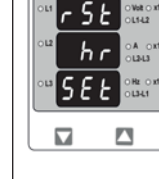

Confirmation of parameter for RESET

Pressing "DOWN" will enter reset menu back and scroll between parameters as above.

Pressing "UP" key will Reset the Selected Parameter. In this case hour parameters will get reset.Then it will enter to auto scrolling or fixed screen selection parameter.

3.2.7 Screen Auto scrolling / Fixed Screen selection

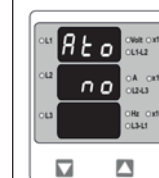

This menu allow to select scrolling or fixed screen.

Pressing "UP" key enters confirmation of Fixed Screen.

Pressing of "DOWN" key enters to Edit menu.

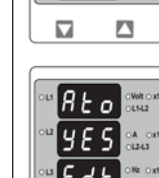

Fixed Screen / Auto Scrolling Edit

Pressing of "DOWN" key Rolls between "Yes" and "No".

Pressing "UP" key enters Auto scrolling / fixed screen select confirmation.

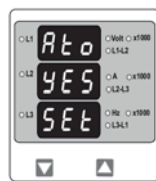

Confirmation of Auto Scrolling / Fixed Screen

Pressing "DOWN" key enter back to edit menu.

Pressing "UP" key confirms the selection and enters Number of poles selection menu.

3.2.8 No. of Poles Selection

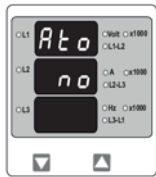

This screen enables to set No. of poles on a Generator of which RPM is to be measured and to which the instrument is connected to measure its output parameters.

Pressing "DOWN" key enters into no. of pole edit menu.

Pressing "UP" key will set the displayed number as No. of poles. Then it advanced to Relay limit parameter selection screen (see section 3.2.9).

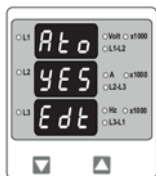

No. of Poles edit

Pressing "DOWN" key scrolls the number from 02 to 40 in step of 2. After 40 it wraps to the number again 02.

Pressing "UP" key enters into No. of poles Confirmation screen.



No. of Poles Confirmation

Pressing "DOWN" key enters back to No. of poles edit menu.

Pressing "UP" key sets the number on screen, 4 in this case, as number of poles of generator and advanced to Relay limit parameter selection screen (see section 3.2.9).

3.2.9 Relay Limit Parameter selection (Optional)



This screen enables user to select Parameter for limit monitoring via a Relay.

Pressing "UP" key selects the displayed parameter for monitoring and enters trip point selection screen.

Pressing "DOWN" key enters Trip parameter edit screen.



Trip parameter edit screen

Pressing "DOWN" key scrolls the parameters one by one as per table 2. Selecting 00(None) disables relay function.

Pressing "UP" key selects the parameter and enters the Trip parameter confirmation screen. In this case displayed number 10 will select VL1-L2. For relay monitoring as per table 2.



Trip parameter confirmation screen

This screen will appear only after parameter edit.

Pressing "DOWN" key will re-enter the parameter selection menu. Pressing "UP" key will set the parameter for relay trip and then it will enter the trip point selection menu.



Trip point selection

This screen will not appear if parameter None (00) is Selected in previous menu. The trip point can be set as % of the Nominal value of selected parameter (Refer Table 2). Pressing "DOWN" key will enter trip point edit screen. Pressing "UP" key will set displayed value as trip point and exit set up.

Further Functionality is same as Potential Transformer Secondary value (see section 3.2.4).

TABLE 2 : Parameters for limit monitoring

Parameter No.	Measured Parameters	3P4W	3P3W	1P2W	Trip point Set range	100% Value
00	None	✓	✓	✓	-	-
01	Voltage L1	✓	✓	✓	10 - 120%	Vnom (L-N)
02	Voltage L2	✓	✓	✓	10 - 120%	Vnom (L-N)
03	Voltage L3	✓	✓	✓	10 - 120%	Vnom (L-N)
04	Current L1	✓	✓	✓	10 - 120%	Inom
05	Frequency	✓	✓	✓	10 - 120%	Inom
06	Voltage VL1-L2	✓	✓	✓	10 - 120%	Inom
07	Current L2	✓	✓	✓	10 - 100%	66Hz ⁽¹⁾
10	Current L3	✓	✓	✓	10 - 120%	Vn (L-L)
11	Voltage VL2-L3	✓	✓	✓	10 - 120%	Vn (L-L)
12	Voltage VL3-L1	✓	✓	✓	10 - 120%	Vn (L-L)
13	System Current	✓	✓	✓	10 - 120%	Vnom ⁽²⁾
14	System Voltage	✓	✓	✓	10 - 120%	Inom

Note : (1) For Frequency 10% corresponds to 45Hz and 100% corresponds to 66Hz.
 (2) For 3P 4wire and 1ph the nominal value is V and that for 3P3W is V_n L-N L-L.
 (3) Nominal Value is to be considered with set CT/PT Primary values.
 (4) For single phase L1 Phase values are to be considered as System values.

4. Installation

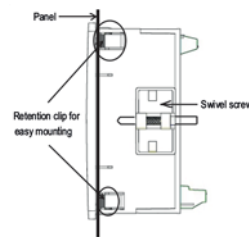

Mounting of RS PRO is featured with easy "Clip-in" mounting. Push the meter in panel slot (size 92 x 92mm), it will click fit into panel with the four integral retention clips on two sides of meter.

If required Additional support is provided with swivel screws (optional) as shown in figure.

The front of the enclosure conforms to IP50. Additional protection to the panel may be obtained by the use of an optional panel gasket. The terminals at the rear of the product should be protected from liquids.

The RS PRO should be mounted in a reasonably stable ambient temperature and where the operating temperature is within the range -10° to 55°C. Vibration should be kept to a minimum and the product should not be mounted where it will be subjected to excessive direct sunlight.

Caution:

- In the interest of safety and functionality this product must be installed by a qualified engineer, abiding by any local regulations.
- Voltag es dangerous to human life are present at some of the terminal connections of this unit. Ensure that all supplies are de-energised before attempting any connection or disconnection.
- These products do not have internal fuses therefore external fuses must be used to ensure safety under fault conditions.

4.1 EMC Installation Requirements

This product has been designed to meet the certification of the EU directives when installed to a good code of practice for EMC in industrial environments. e.g. screened output and low signal input leads or have provision for fitting RF suppression components, such as ferrite absorbers, line filters etc., in the event that RF fields cause problems.

Note: It is good practice to install sensitive electronic instruments that are performing critical functions, in EMC enclosures that protect against electrical interference which could cause a disturbance in function.

Avoid routing leads alongside cables and products that are, or could be, a source of interference.

To protect the product against permanent damage, surge transients must be limited to 2kV pk. It is good EMC practice to suppress differential surges to 2kV at the source. The unit has been designed to automatically recover in the event of a high level of transients. In extreme circumstances it may be necessary to temporarily disconnect the auxiliary supply for a period of greater than 5 seconds to restore correct operation.

The Current inputs of these products are designed for connection in to systems via Current Transformers only, where one side is grounded.

ESD precautions must be taken at all times when handling this product.

4.2 Case Dimension and Panel Cut Out

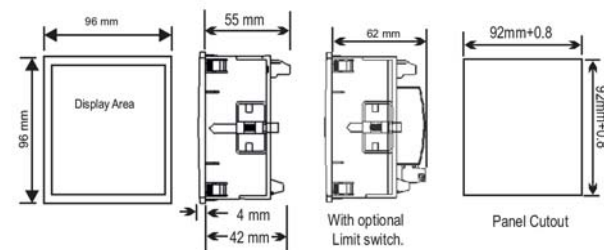

4.3 Wiring

Input connections are made directly to screw-type terminals with indirect wire pressure. Numbering is clearly marked on the connector. Choice of cable should meet local regulations. Terminal for both Current and Voltage inputs will accept upto 4mm² (12AWG) solid or 2.5 mm² (12AWG) standard cable.

Note: It is recommended to use wire with lug for connection with meter.

4.4 Auxiliary Supply

RS PRO should ideally be powered from a dedicated supply, however it may be powered from the signal source, provided the source remains within the limits of the chosen auxiliary voltage range.

4.5 Fusing

It is recommended that all voltage lines are fitted with 1 amp HRC fuse.

4.6 Earth/Ground Connections

For safety reasons, CT secondary connections should be grounded in accordance with local regulations.

5. Connection Diagram

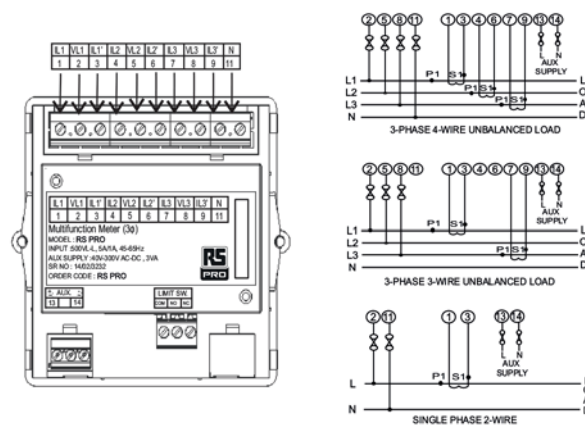

6. Optional Pluggable Module

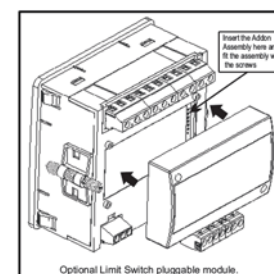

7. Specification

System

3 Phase 3 Wire / 4 Wire or Single Phase programmable at site

Inputs

Nominal Input Voltage

System PT Primary values	100V - 500 VL-L
System PT Secondary values	57.7V - 290 VL-L
Max continuous input voltage	100VL-L to 799 kVL-L programmable at site
Max short duration input voltage	100VL-L to 500 VL-L, programmable at site
	120% of Rated value
	2 x Rated value (1s application repeated 10 times at 10s intervals)
Nominal input voltage burden	< 0.3 VA Approx. per phase

Nominal Input Current

Max continuous input 1 current	1A / 5A AC
Nominal input current burden	20% of Rated value
Max short duration input current	< 0.2 VA Approx. per phase
	20 x Rated value (1s application repeated 5 times at 5 min. interval)
System CT Primary values	1A to 799 K Amps programmable at site
System CT Secondary values	1A or 5A programmable at site

Operating Measuring Ranges

Voltage	10 ... 120% of Rated value
Current	5 ... 120% of Rated value
Frequency	45 Hz ... 65 Hz

NOTE: When Voltage input is absent, current measurement starts from 75 mA.

Auxiliary

External Auxiliary Supply 40V to 300V AC/DC (+/- 5%)

Frequency Range 45 to 65 Hz
 VA Burden < 4 VA

Accuracy

Voltage +1.0 % of nominal value
 Current +1.0 % of nominal value
 Frequency +0.5 % of mid frequency

Reference conditions for Accuracy

Reference temperature 23°C + 2°C
 Current 10... 100% of nominal value
 Voltage 20... 100% of nominal value
 Input frequency 50 / 60Hz + 2%
 Input waveform Sinusoidal (distortion factor 0.005)
 Auxiliary supply voltage Rated Value + 1 %
 Auxiliary supply frequency Rated Value + 1 %

Relay

Settable parameters as per table 2
 Trip Point setting 10%...120% of set range of parameter (except frequency which is 10%...100%)

Hysteresis 5% of trip point
 Contact type single pole NO+NC, volt free contacts
 Contact rating 250V, 5A

Influence of Variations

Temperature Coefficient 0.05% / °C

Display

LED 3 line 3 digits, Display height : 14mm
 Update rate Approx. 1 seconds

Controls

User Interface 2 Keys

Applicable Standards

EMC IEC 61326
 Immunity IEC 61000-4-3. 10V/m min – Level 3
 Safety IEC 61010-1-2010, Permanently connected use
 IP for water & dust IEC 60529
 Pollution degree 2
 Installation category III

Isolation

High Voltage Test 3.3 kV AC, 50 Hz for 1 minute between all Electrical circuits

Environmental

Operating temperature -10 to +55°C
 Storage temperature -20 to +65°C
 Relative humidity 0... 90% non condensing
 Warm up time Minimum 3 minute
 Shock 15g in 3 planes
 Vibration 10... 150.... 10 Hz, 0.15mm amplitude
 Enclosure front IP50
 Enclosure back IP20

Enclosure

Style 96mm x 96mm DIN Quadratic
 Material Polycarbonate Housing
 Terminals Screw-type terminals
 Depth < 60 mm
 Weight 300 grams Approx.

Article codes

Article No : 136-5377
 RS Pro Volts, Amps and Frequency, 96X96mm 3 Phase 3/4W programmable onsite, AC VAF meter, 14mm display, Input. 100-500VLL, Input. 1 or 5 Amps AC, Supply Voltage. 40-300V AC/DC auxiliary (Programmable CT/PT primary and secondary values)

Article No : 136-5378

RS Pro Volts, Amps and Frequency, 96X96mm 3 Phase 3/4W programmable onsite, AC VAF meter, 14mm display, Input. 100-500VLL, Input. 1 or 5 Amps AC, Supply Voltage. 40-300V AC/DC auxiliary (Programmable CT/PT primary and secondary values with Limit Switch/Relay O/P)

The information contained in these installation instructions is for use only by installers trained to make electrical power installations and is intended to describe the correct method of installation for this product. However, Company has no control over the field conditions which influence product installation. It is the user's responsibility to determine the suitability of the installation method in the user's field conditions. Company only obligations are those in Company standard Conditions of Sale for this product and in no case Company be liable for any other incidental, indirect or consequential damages arising from the use or misuse of the products.

FOR MORE INFORMATION VISIT THIS SITE
<http://www.rs-components.com/index.html>