

# WM40

## Power analyzer for three-phase systems



### Description

WM40 is a modular power analyzer for single-, two- and three-phase systems.

It is made up of a maximum of four components: the main unit that displays measurements on the LCD display and manages 16 alarms, and three accessory modules, one with digital outputs or analogue outputs, one with analogue outputs, digital inputs and outputs or analogue inputs and the other for communication.

The digital output module associates alarms with static or relay outputs and/or transmits pulses proportional to energy consumption.

The analogue output module associates 0-20mA or 0-10 V outputs to measured variables.

The digital input/output module allows alarm or pulse transmission via digital outputs, tariff management, pulse counting or DMD synchronization via digital inputs.

The analogue input module allows temperature, process signal and real neutral current monitoring.

The communication module allows you configure the analyzer and transmit data using a different communication protocol according to the version and, if equipped with memory on board, permits log of data and events.

### Benefits

- **Clarity.** The wide backlit LCD display clearly shows the measurements and the configuration parameter values.
- **Simplicity.** An optical port is available for quick analyzer configuration using OptoProg (CARLO GAVAZZI).
- **Specific software.** WM40 can be configured and measurements viewed from UCS configuration software (CARLO GAVAZZI). The software and subsequent updates are free.
- **Scalability.** Three accessory modules can be added to WM40 according to need. This way, the analyzer extends its control capacities and communicates data remotely.
- **Communication flexibility.** The communication module is available in Modbus RTU, Modbus TCP/IP, BACnet IP, BACnet MS/TP and Profibus DP V0 versions.
- **Fast installation.** WM40 and accessory modules are all equipped with detachable terminals. Modules can be quickly installed via the specifically designed fast coupling pins.
- **Tamper-proof.** WM40 configuration access can be locked. Terminals and accessory modules can be sealed.

## Main functions

- Measure main electrical variables and voltage and current harmonic distortions
- Measure active and reactive energy
- Measure load operating hours
- Manage up to 16 alarms
- Manage up to 8 digital outputs (via optional accessory modules)
- Manage up to 6 digital inputs (via optional accessory modules)
- Manage temperature, process signal and real neutral current (via optional accessory module)
- Manage up to 4 analogue outputs (via optional accessory modules)
- Manage process signal, temperature and real neutral current input (via optional accessory module)
- Transmit data to other systems (via optional accessory module)

## Applications

WM40 can be installed in any switchboard to control energy consumption, main electrical variables and harmonic distortion.

In automation, WM40 can use the communication module with Profibus protocol to both communicate data on consumption to supervision systems and manage them independently if installed on a machine.

In building, WM40 can be installed in existent architectures using the communication module with BACnet protocol (on RS485 or Ethernet).

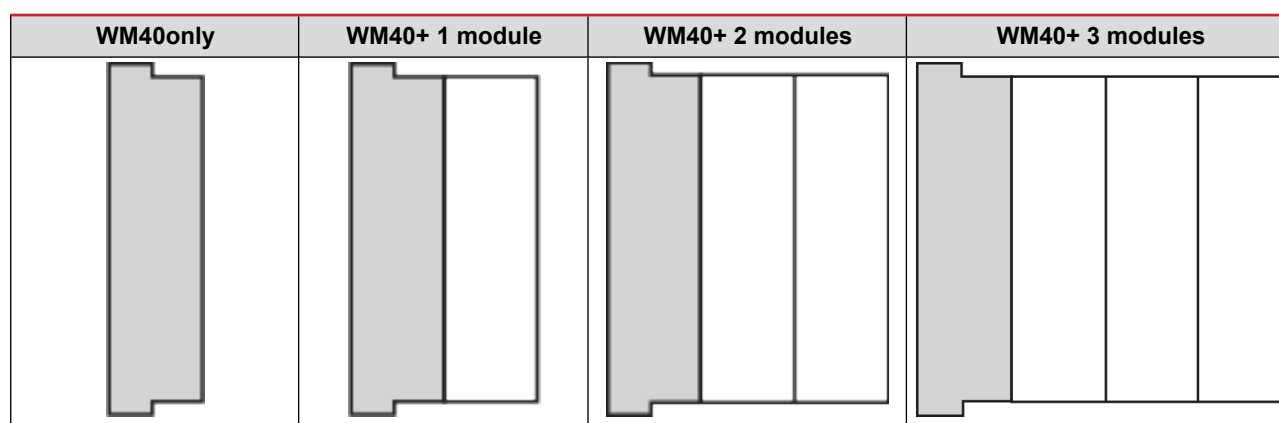
## Components

Module	Description
<b>WM40</b>	Main unit, measures and displays main electrical variables. With LCD display and touch keypad, it lets you set measurement parameters, configure accessory modules and manage up to 16 alarms.
<b>Digital inputs/outputs (optional)</b>	Accessory module with 4 or 6 digital outputs and 6 digital inputs. Expands main unit capacity, specifically allowing you to: transmit pulses proportional to energy consumption control digital outputs (static or relay according to the module) synchronize DMD calculation with digital inputs control tariffs reset alarms count pulses
<b>Analogue inputs (optional)</b>	Accessory module that lets you: read temperature values monitor a process signal measure real neutral current
<b>Communication (optional)</b>	Accessory module that lets you transmit data to other systems or configure the analyzer from remote

### Compatible accessory modules

Type	Module description	Code
Digital outputs	Double static output	M O O2
	Double relay output	M O R2
Analogue outputs	Double analogue output (+20mA dc)	M O A2
	Double analogue output (+10V dc)	M O V2
Digital inputs/outputs	6 digital inputs and 6 static outputs	MF I6 O6
	6 digital inputs and 4 relay outputs	MF I6 R4
Analogue inputs	Temperature and analogue input (process signal)	M ATP
	Temperature, analogue input and neutral current direct measurement	M ATPN
Communication	Modbus RTU communication on RS485/RS232	M C 485232
	Modbus RTU communication on RS485/RS232+memory	M C 485232 M
	Modbus TCP/IP communication on Ethernet	M C ETH
	Modbus TCP/IP communication on Ethernet+memory	M C ETH M
	BACnet IP communication on Ethernet	M C BAC IP
	BACnet IP communication on Ethernet+memory	M C BAC IP M
	BACnet MS/TP communication on RS485	M C BAC MS
	BACnet MS/TP communication on RS485+memory	M C BAC MS M
	Profibus DP V0 communication on RS485	M C PB
Profibus DP V0 communication on RS485+memory	M C PB M	

### Possible configurations



**NOTICE:** maximum 1 module per type with exception of analogue output modules (2 max). In the configuration with 2 or 3 modules, the communication module is installed last.

## Features

### General features

<b>Material</b>	Front: ABS, self-extinguishing V-0 (UL 94) Back and accessory modules: PA66, self-extinguishing V-0 (UL 94)
<b>Protection degree</b>	Front: IP65 NEMA 4x NEMA 12 Terminals: IP20
<b>Terminals</b>	Type: detachable Section: 2.5 mm <sup>2</sup> maximum Torque: 0.5 Nm
<b>Overvoltage category</b>	Cat. III
<b>Pollution degree</b>	2
<b>Rejection (CMRR)</b>	100 dB, from 42 to 62 Hz
<b>Insulation</b>	Double electrical insulation on areas accessible to the user. For insulation between inputs and outputs, see "Input and output insulation" below.

### Input and output insulation

**Note:** test conditions: 4 kV rms ac for one minute.

Type	Power supply (H or L) [kV]	Measurement inputs [kV]	Relay outputs MOR2 [kV]	Relay outputs MFI6R4	Static outputs MOO2	Static outputs MFI6O-6	Digital inputs [kV]	Analogue outputs	Analogue inputs	Serial port [kV]	Ethernet port [kV]
Power supply (H or L)	-	4	4	4	4	4	4	4	4	4	4
Measurement inputs	4	-	4	4	4	4	4	4	4	4	4
Relay outputs MOR2	4	4	2	4	4	4	4	4	4	4	4
Relay outputs MFI6R4	4	4	4	2	4	4	4	4	4	4	4
Static outputs MOO2	4	4	4	4	2	4	4	4	4	4	4
Static outputs MFI6O6	4	4	4	4	4	2	4	4	4	4	4
Digital inputs	4	4	4	4	4	4	-	4	4	4	4
Analogue outputs	4	4	4	4	4	4	4	-	4	4	4

Type	Power supply (H or L) [kV]	Measurement inputs [kV]	Relay outputs MOR2 [kV]	Relay outputs MFI6R4	Static outputs MOO2	Static outputs MFI6O-6	Digital inputs [kV]	Analogue outputs	Analogue inputs	Serial port [kV]	Ethernet port [kV]
Analogue inputs	4	4	4	4	4	4	4	4	4*	-	4
Serial port	4	4	4	4	4	4	4	4	4	-	NP
Ethernet port	4	4	4	4	4	4	4	4	4	NP	-

#### Key

- NP: combination not possible
- 4: 4 kV rms insulation (EN 61010-1, IEC 60664-1, overvoltage category III, pollution degree 2, double insulation on system with maximum 300 V rms to ground)


**Note:** \*between two different modules

#### Environmental specifications

Operating temperature	From -25 to +55 °C/from -13 to +131 °F
Storage temperature	From -30 to +70 °C/from -22 to 158 °F

**Note:** R.H. < 90 % non-condensing @ 40 °C / 104 °F.

#### Conformity

Directives	2014/35/EU (LVT - Low Voltage) 2014/30/EU (Electromagnetic Compatibility) 2011/65/EU (Electric-electronic equipment hazardous substances)
Standards	Electromagnetic compatibility (EMC) - emissions and immunity: EN61000-6-3, EN61000-6-2 Electrical safety: EN 61010-1 Metrology: EN62053-22, EN62053-23 Pulse output: IEC 62053-31, DIN 43864
Approvals	

# Main unit



## Description

Main unit with LCD display and touch keypad to view measurements, configure the system and manage 16 alarms.

It can be integrated by digital output, analogue output, digital input/output, analogue input and communication modules.

Four versions are available (AV4, AV5, AV6 and AV7) to manage different current and voltage inputs.

It can be quickly configured with OptoProg via optical port.

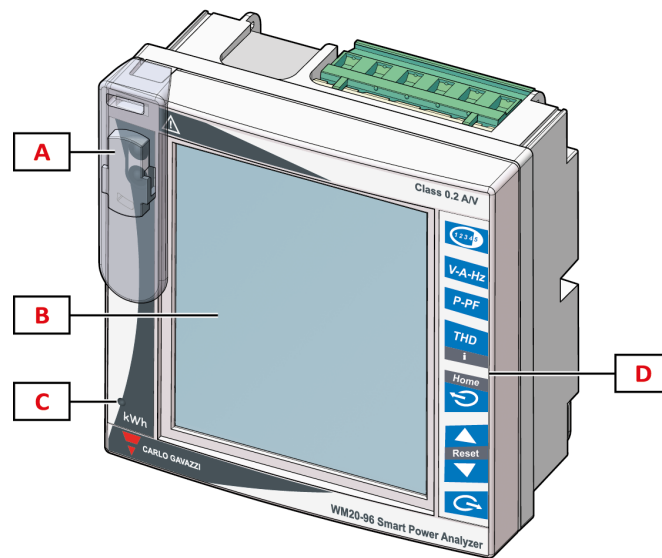
## Main features

- System and phase variables (4 x 3 digits): V L-L, V L-N, A, W/var/VA, PF, Hz
- Active and reactive imported and exported energy meters (10 digits)
- Calculate the average and maximum system and phase values of all the electrical variables
- Calculate current and voltage THD (total harmonic distortions) and single harmonics up to the 32nd harmonic
- Calculate load operating hours
- Auxiliary power supply
- 16 virtual alarms
- Backlit LCD display and touch keypad
- Optical port
- Detachable terminals
- Sealable terminal caps
- Configuration via keypad or UCS configuration software
- Filter to stabilize displayed measurements

## Main functions

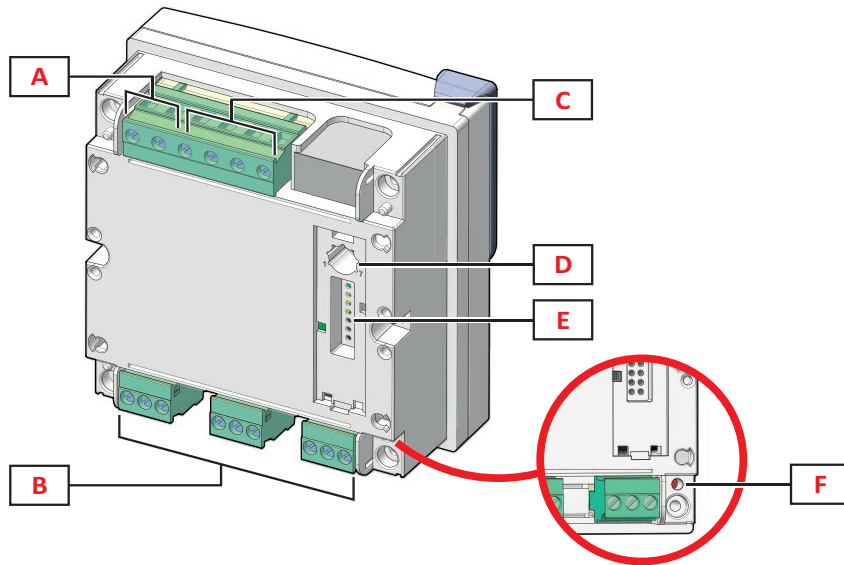
- Measure main electrical variables and harmonic voltage and current distortions
- Measure single harmonics (raw data via communication and harmonics graph via UCS software)
- Measure active and reactive energy
- Measure load operating hours
- Manage up to 16 alarms

## Structure



**Fig. 1 Front**

Element	Description
<b>A</b>	Optical port and plastic support for OptoProg (CARLO GAVAZZI) connection
<b>B</b>	Backlit LCD display
<b>C</b>	LED that blinks with frequency proportional to active energy consumption, see "LED" on page 15
<b>D</b>	Touch keypad



**Fig. 2 Back**

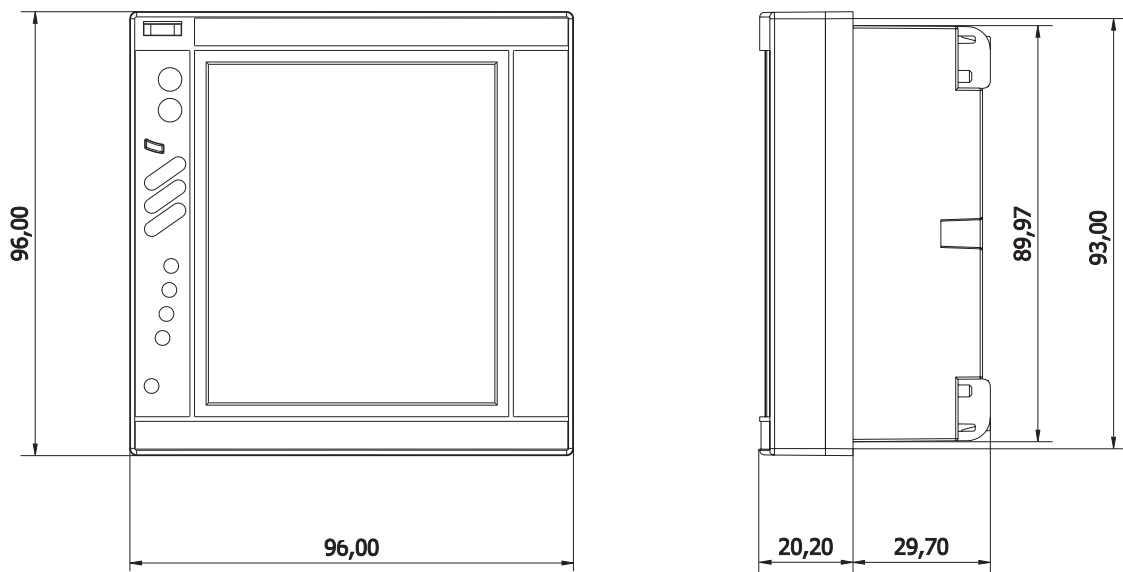
Element	Description
A	Detachable power supply terminals
B	Detachable current input terminals
C	Detachable voltage input terminals
D	Rotary selector to lock configuration
E	Local bus port for accessory modules
F	Power supply status LED, see "LED" on page 15



## Features

### General features

<b>Assembly</b>	Panel mounting
<b>Weight</b>	420 g (packaging included)



### Electrical specifications

<b>Electrical system</b>	
<b>Managed electrical system</b>	Single-phase (2-wire) Two-phase (3-wire) Three-phase with neutral (4-wire) Three-phase without neutral (3-wire)

Voltage inputs				
Inputs	AV4	AV5	AV6	AV7
<b>Voltage connection</b>	Direct or via VT/PT			
<b>VT/PT transformation ratio</b>	From 1 to 9999			
<b>Rated voltage L-N (from Un min to Un max)</b>	From 220 to 400 V		From 57.7 to 133 V	
<b>Rated voltage L-L (from Un min to Un max)</b>	From 380 to 690 V*		From 100 to 230 V	
<b>Voltage tolerance</b>	-20%, + 15%			

Voltage inputs	
Overload	Continuous: 1.2 Un max For 500 ms: 2 Un max
Input impedance	>1.6 MΩ
Frequency	From 40 to 440 Hz

**Note:** \*for UL applications max 600 VL-L, 40 °C (104 °F)

Current inputs				
Inputs	AV4	AV5	AV6	AV7
Current connection	Via CT			
CT transformation ratio	From 1 to 9999			
Rated current (In)	1 A	5 A		1 A
Minimum current (Imin)	0.01 A	0.05 A		0.01 A
Maximum current (Imax)	2 A	6 A		2 A
Start-up current (Ist)	1 mA	5 mA		1 mA
Overload	Continuous: Imax For 500 ms: 20 Imax			
Input impedance	< 0.2 VA			
Maximum CTxVT ratio	9999 x 9999			

### Power supply

	H	L
Power supply	From 100 to 240 V ac/dc ± 10%	From 24 to 48 V ac/dc ± 15%
Consumption	10 W, 20 VA	

### Measurements

Method	TRMS measurements of distorted waveforms
Sampling	3200 samples/s @50 Hz 3840 samples/s @60 Hz

### Available measurements

Active energy	Unit	System	Phase
Imported (+) Total	kWh+	•	-
Imported (+) partial	kWh+	•	-
Exported (+) Total	kWh-	•	-
Exported (+) partial	kWh-	•	-

Reactive energy	Unit	System	Phase
Imported (+) Total	kvarh+	•	-
Imported (+) partial	kvarh+	•	-
Exported (+) Total	kvarh-	•	-
Exported (+) partial	kvarh-	•	-

Electrical variable	Unit	System	Phase
<b>Current</b>	A	•	•
MIN	A	•	•
DMD	A	•	•
MAX	A	•	•
DMD MAX	A	•	•
<b>Neutral current</b>	A	•	-
MIN	A	•	-
DMD	A	•	-
MAX	A	•	-
DMD MAX	A	•	-
<b>Voltage L-N</b>	V	•	•
MIN	V	•	•
DMD	V	•	•
MAX	V	•	•
DMD MAX	V	•	•
<b>Voltage L-L</b>	V	•	•
MIN	V	•	•
DMD	V	•	•
MAX	V	•	•
DMD MAX	V	•	•
<b>Active power</b>	kW	•	•
MIN	kW	•	•
DMD	kW	•	•
MAX	kW	•	•
DMD MAX	kW	•	•
<b>Apparent power</b>	kVA	•	•
MIN	kVA	•	•
DMD	kVA	•	•
MAX	kVA	•	•
DMD MAX	kVA	•	•
<b>Reactive power</b>	kvar	•	•
MIN	kvar	•	•

Electrical variable	Unit	System	Phase
<b>DMD</b>	kvar	•	•
<b>MAX</b>	kvar	•	•
<b>DMD MAX</b>	kvar	•	•
<b>Power factor</b>	PF	•	•
<b>MIN</b>	PF	•	•
<b>DMD</b>	PF	•	•
<b>MAX</b>	PF	•	•
<b>DMD MAX</b>	PF	•	•
<b>Frequency</b>	Hz	•	-
<b>MIN</b>	Hz	•	-
<b>DMD</b>	Hz	•	-
<b>MAX</b>	Hz	•	-
<b>DMD MAX</b>	Hz	•	-
<b>THD Current*</b>	THD A %	-	•
<b>MIN</b>	THD A %	-	•
<b>DMD</b>	THD A %	-	•
<b>MAX</b>	THD A %	-	•
<b>DMD MAX</b>	THD A %	-	•
<b>THD odd Current*</b>	THD A %	-	•
<b>MIN</b>	THD A %	-	•
<b>DMD</b>	THD A %	-	•
<b>MAX</b>	THD A %	-	•
<b>DMD MAX</b>	THD A %	-	•
<b>THD even Current*</b>	THD A %	-	•
<b>MIN</b>	THD A %	-	•
<b>DMD</b>	THD A %	-	•
<b>MAX</b>	THD A %	-	•
<b>DMD MAX</b>	THD A %	-	•
<b>THD Voltage L-N*</b>	THD L-N %	-	•
<b>MIN</b>	THD L-N %	-	•
<b>DMD</b>	THD L-N %	-	•
<b>MAX</b>	THD L-N %	-	•
<b>DMD MAX</b>	THD L-N %	-	•
<b>THD odd Voltage L-N*</b>	THD L-N %	-	•
<b>MIN</b>	THD L-N %	-	•
<b>DMD</b>	THD L-N %	-	•
<b>MAX</b>	THD L-N %	-	•
<b>DMD MAX</b>	THD L-N %	-	•

Electrical variable	Unit	System	Phase
THD even Voltage L-N*	THD L-N %	-	•
MIN	THD L-N %	-	•
DMD	THD L-N %	-	•
MAX	THD L-N %	-	•
DMD MAX	THD L-N %	-	•
THD Voltage L-L*	THD L-L %	-	•
MIN	THD L-L %	-	•
DMD	THD L-L %	-	•
MAX	THD L-L %	-	•
DMD MAX	THD L-L %	-	•
THD odd Voltage L-L*	THD L-L %	-	•
MIN	THD L-L %	-	•
DMD	THD L-L %	-	•
MAX	THD L-L %	-	•
DMD MAX	THD L-L %	-	•
THD even Voltage L-L*	THD L-L %	-	•
MIN	THD L-L %	-	•
DMD	THD L-L %	-	•
MAX	THD L-L %	-	•
DMD MAX	THD L-L %	-	•
TDD Current*	TDD A %	-	•
MIN	TDD A %	-	•
DMD	TDD A %	-	•
MAX	TDD A %	-	•
DMD MAX	TDD A %	-	•
K-factor/factor K	-	-	•
MIN	-	-	•
DMD	-	-	•
MAX	-	-	•
DMD MAX	-	-	•
Run hour meter	h	•	-

\* Up to 32<sup>nd</sup> harmonic

**Note:** the available variables depend on the type of system set.

### Measurement mode

Depending on the APPLICATION setting, a different selection of variables is available on the display. The energy calculation is not affected and works always as bidirectional.

### Energy metering

For every measuring interval time, the energies of the single phases are summed; according to the sign of the result, the positive (kWh+) or negative totalizer (kWh-) is increased.

Example:

P L1= +2 kW, P L2= +2 kW, P L3= -3 kW

Integration time = 1 hour

+kWh=(+2+2-3)x1h=(+1)x1h=1 kWh

-kWh=0 kWh

### Measurement accuracy

Current	
From 0.05 In to I <sub>max</sub>	$\pm(0.2\% \text{ rdg} + 2 \text{ dgt})$
From 0.01 In to 0.05 In	$\pm(0.5\% \text{ rdg} + 2 \text{ dgt})$
Phase-phase voltage	
From Un min -20% to Un max +15%	$\pm(0.2\% \text{ rdg} + 1 \text{ dgt})$
Phase-neutral voltage	
From Un min -20% to Un max +15%	$\pm(0.5\% \text{ rdg} + 1 \text{ dgt})$
Active and apparent power	
From 0.05 In to I <sub>max</sub> (PF=0.5L, 1, 0.8C)	$\pm(0.5\% \text{ rdg} + 1 \text{ dgt})$
From 0.01 In to 0.05 In (PF=1)	$\pm(1\% \text{ rdg} + 1 \text{ dgt})$

Reactive power	
From 0.1 In to I <sub>max</sub> (sinφ=0.5L, 0.5C) From 0.05 In to I <sub>max</sub> (sinφ=1)	±(1% rdg + 1 dgt)
From 0.05 In to 0.1 In (sinφ=0.5L, 0.5C) From 0.02 In to 0.05 In (PF=1)	±(1.5% rdg + 1 dgt)
Power factor	±[0.001+0.5%(1 – PF rdg)]
Active energy	Class 0.5S (EN62053-22), class 0.5 (ANSI C12.20)
Reactive energy	Class 2 (EN62053-23, ANSI C12.1)
THD	±1%
TDD	±1%

Frequency	
From 45 to 65 Hz	±(0.02% rdg + 1 dgt)
From 65 to 340 Hz	±(0.05% rdg + 1 dgt)
From 340 to 440 Hz	±(0.1% rdg + 1 dgt)

## Display

Type	Backlit LCD
Refresh time	250 ms
Description	5 rows: • 1st: 10 digits (6 mm) • 2nd, 3rd, 4th, 5th: 4 digits (9.5 mm)
Variable readout	Instantaneous: 4 digits, min: 0.001, max: 9 999 Energy: 10 digits, min: 0.01, max: 9 999 999 999

## LED

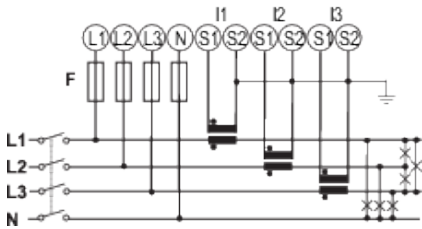
Front	Red. Weight: proportional to energy consumption and depending on the CT and VT/ PT ratio product (16 Hz maximum frequency):	
	Weight (kWh per pulse)	CT*VT/PT
	0.001	≤ 7
	0.01	From 7.1 to 70
	0.1	From 70.1 to 700
	1	From 700.1 to 7000
	10	From 7001 to 70 k
	100	> 70.01 k
	Red (G1, G2, G3, G4). Groups of Alarm status.	
Back	Green. Power supply status.	

### Special functions

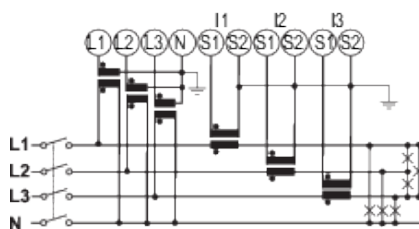
- 16 virtual alarms (up, down, in or out alarm)
- Filter to stabilize variable measurements with high fluctuations
- Load operating hour meter
- Clock
- Tariff management by clock/calendar, digital inputs or communication
- Total active and reactive energy meters and average, minimum, max dmd and maximum values reset
- Optical port for configuration via OptoProg
- Password protected settings menu



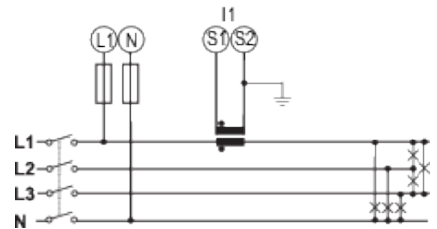
## Connection Diagrams



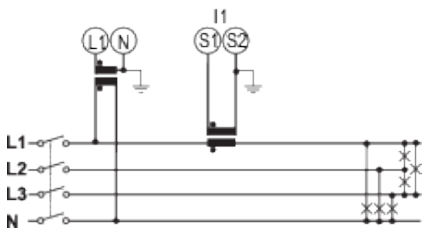
**Fig. 3** Three-phase system with neutral (4-wire, 3P.n), unbalanced load and 3 CT. 315 mA fuse (F).



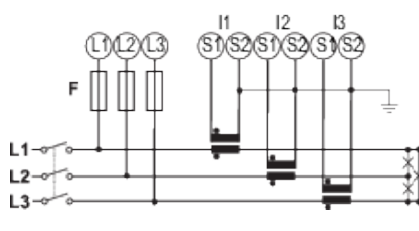
**Fig. 4** Three-phase system with neutral (4-wire, 3P.n), unbalanced load, 3 CT and 3 VT/PT.



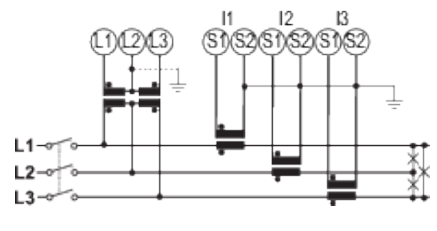
**Fig. 5** Three-phase system with neutral (4-wire, 3P.2), balanced load, 1 CT. 315 mA fuse (F).



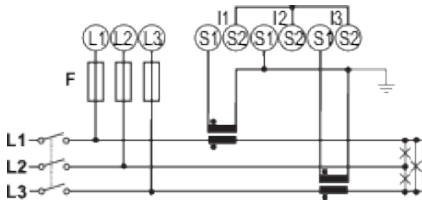
**Fig. 6** Three-phase system with neutral (4-wire, 3P.2), balanced load, 1 CT and 1 VT/PT.



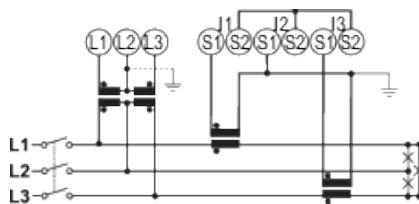
**Fig. 7** Three-phase system without neutral (3-wire, 3P), unbalanced load and 3 CT. 315 mA fuse (F).



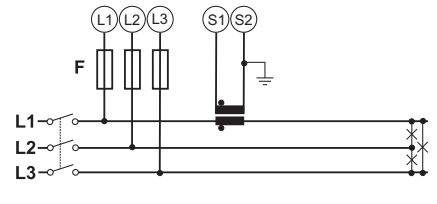
**Fig. 8** Three-phase system without neutral (3-wire, 3P), unbalanced load, 3 CT and 2 VT/PT.



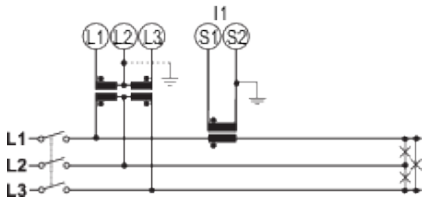
**Fig. 9** Three-phase system without neutral (3-wire, 3P) unbalanced load and 2 CT (Aron). 315 mA fuse (F).



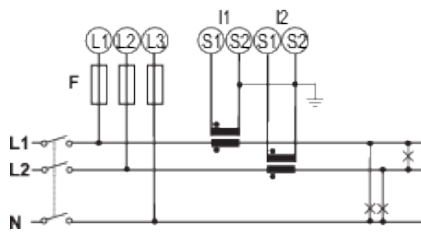
**Fig. 10** Three-phase system without neutral (3-wire, 3P), unbalanced load, 2 CT (Aron) and 2 VT/PT.



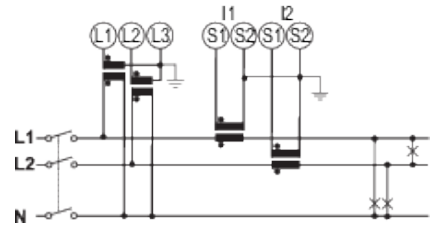
**Fig. 11** Three-phase system without neutral (3-wire, 3P.1), balanced load, 1 CT.



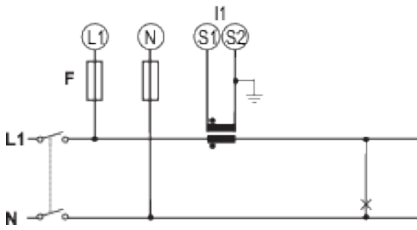
**Fig. 12** Three-phase system without neutral (3-wire, 3P.1), balanced load, 1 CT and 2 VT/PT.



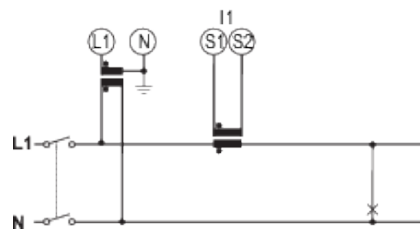
**Fig. 13** Two-phase system (3-wire, 2P), 2 CT, 315 mA fuse (F).



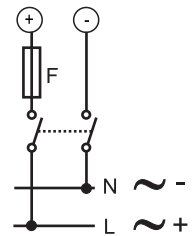
**Fig. 14** Two-phase system (3-wire, 2P), 2 CT and 2 VT/PT.



**Fig. 15** Single-phase system (2-wire, 1P), 1 CT, 315 mA fuse (F).



**Fig. 16** Single-phase system (2-wire, 1P), 1 CT and 1 VT/PT.



**Fig. 17** Auxiliary power supply (H). 250 V [T] 630 mA fuse (F).  
Auxiliary power supply (L). 250 V [T] 3.15 A fuse (F).

## References


 WM40 AV  3  (9 characters total)

Enter the code option instead of


Code	Options	Description
W	-	-
M	-	-
4	-	-
0	-	-
A	-	-
V	-	-
<input type="checkbox"/>	4	From 380 to 690 V L-L ac, 1(2) A, connection via CT
	5	From 380 to 690 V L-L ac, 5(6) A, connection via CT
	6	From 100 to 230 V L-L ac, 5(6) A, connection via CT
	7	From 100 to 230 V L-L ac, 1(2) A, connection via CT
3	-	-
<input type="checkbox"/>	H	auxiliary power supply from 100 to 240 V ac/dc
	L	auxiliary power supply from 24 to 48 V ac/dc

### Further reading

Information	Document	Where to find it
Instruction manual	Instruction manual - WM40	<a href="http://www.productselection.net">www.productselection.net</a>

 **CARLO GAVAZZI compatible components**

Purpose	Component name/-code	Notes
Current measurement accessories	CTD1X, CTD2X, CTD3X, CTD4X	Solid core current transformers (1 or 5 A secondary current, 40 to 1600 A primary current) for cable or bus bar. See relevant datasheets.
	CTD1Z	Solid core current transformers (5 A secondary current, 50 to 200 A primary current) for cable or bus bar. See relevant datasheets.
	CTA5, CTA6	Split core current transformers for retrofit applications (5 A secondary current, 100 to 600 A primary current) for cable or bus bar. See relevant datasheets.
	CTD5S, CTD6S, CTD8S, CTD9S, CTD10S	Split core current transformers (1 or 5 A secondary current, 100 to 3200 A primary current) for bus bar. See relevant datasheets.
	CTD8V, CTD8V, CTD9V, CTD9H, CTD10V, CTD10H	Solid core current transformers (1 or 5 A secondary current, 150 to 3200 A primary current) for bus bar. See relevant datasheets.
	CTD8Q	Solid core current transformers (5 A secondary current, 1000 to 4000 A primary current) for bus bar. See relevant datasheets.
Manage two digital outputs/associate alarms to digital outputs	M O O2 M O R2	See "Digital output modules" on page 22
Manage two analogue outputs	M O A2 M O V2	See "Analogue output modules" on page 28
Manage 6 digital inputs and 4 relay outputs	MF I6 R4	See "Digital input/output modules" on page 34
Manage 6 digital inputs and 6 static outputs	MF I6 O6	See "Digital input/output modules" on page 34
Manage a temperature input and a process signal (analogue input)	MATP	See "Analogue output modules" on page 28
Manage a temperature input, a process signal (analogue input) and a neutral current input	MATPN	See "Analogue output modules" on page 28
Transmit data remotely	M C 485232 M C ETH M C BAC IP M C BAC MS M C PB	See "Communication modules" on page 47
Transmit data remotely and log data/events	M C 485232 M M C ETH M M C BAC IP M M C BAC MSM M C PB M	See "Communication modules" on page 47

Purpose	Component name/-code	Notes
Configure analyzer via desktop application	UCS configuration software	Available for free download at: <a href="http://www.gavazziautomation.com">www.gavazziautomation.com</a>
Configure analyzer via Mobile Android App	UCS Mobile Android App	Available for free download at: Google Play Store 
Monitor data from several analyzers	VMU-C, UWP3.0	See relevant datasheet
Quickly configure several analyzers via optical interface	OptoProg	See relevant datasheet
RS485/USB conversion	SIU-PC3	See relevant datasheet

# Digital output modules



## Description

Accessory module for WM analyzer family that associates static or relay outputs to alarms and/or transmits pulses proportional to energy consumption. Each output can run three different functions: alarm, remote control or pulse.

## Main features

- Two digital outputs (static or relay)
- Three possible functions for each output
- Configuration via main unit keypad or UCS configuration software
- Easy mounting on main unit
- Detachable terminals
- Local bus connection to main unit

## Main functions

- Manage two static or relay outputs
- Associate static or relay outputs with alarms
- Transmit pulses proportional to energy consumption

## Structure

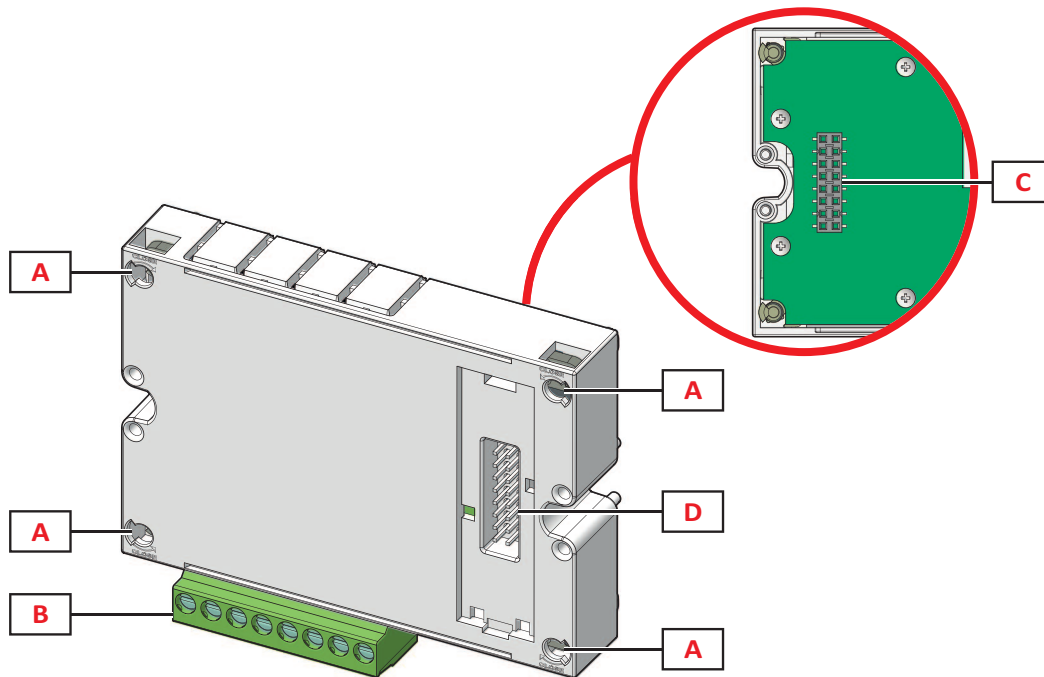


Fig. 18 Front

Element	Description
A	Main unit fastening pins
B	Detachable digital output terminals
C	Local bus port for main unit
D	Local bus port for communication module

### ▶ Digital output functions

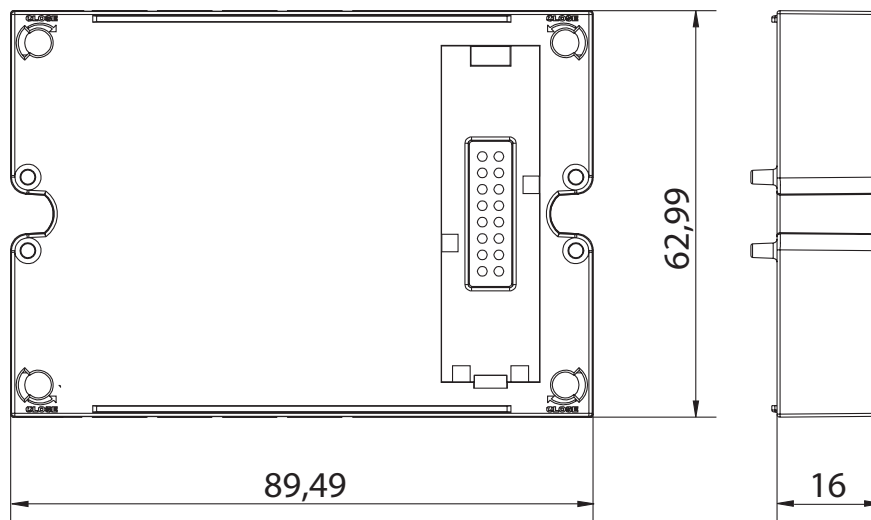
Digital outputs can run three different functions:

- Alarm: output associated with an alarm and directly managed by WM40
- Remote control: output status managed via communication
- Pulse: pulse transmission output on active or reactive, imported or exported energy consumption.

## Features

### General

<b>Mounting</b>	On main unit
<b>Weight</b>	80g
<b>Power supply</b>	Self power supply via local bus



### Static output module (M O O2)

<b>Maximum number of outputs</b>	2
<b>Type</b>	Opto-mosfet
<b>Features</b>	$V_{ON}$ : 2.5 V dc, 100 mA max $V_{OFF}$ : 42 V dc max
<b>Configuration parameters</b>	Output function: alarm/remote control/pulse Associated output alarm and normal status ("alarm" function only) Pulse weight, transmitted energy type, test transmission settings ("pulse" function only)
<b>Configuration mode</b>	Via keypad or UCS software

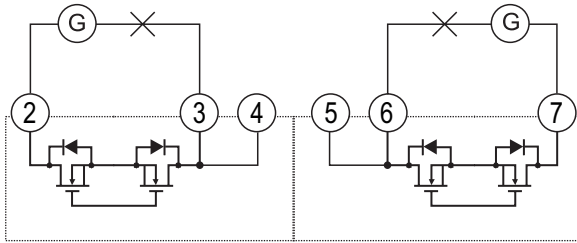
### Relay output module (M O R2)

<b>Maximum number of outputs</b>	2
<b>Type</b>	SPDT relay

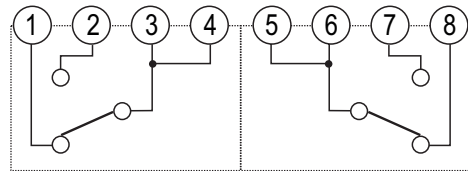


<b>Features</b>	AC1: 5 A @ 250 V ac AC15: 1 A @250 V ac
<b>Configuration parameters</b>	Output function: alarm/remote control/pulse Associated output alarm and normal status ("alarm" function only) Pulse weight, transmitted energy type, test transmission settings ("pulse" function only)
<b>Configuration mode</b>	Via keypad or UCS software

## Connection Diagrams



**Fig. 19** M O O2. Double static opto-mosfet output.



**Fig. 20** M O R2. Double relay output.

## References

### ▶ Order code

Code	Description
<b>M O O2</b>	Double static output
<b>M O R2</b>	Double relay output

### ▶ Further reading

Information	Document	Where to find it
Instruction manual - WM40	Instruction manual - WM40	<a href="http://www.productselection.net">www.productselection.net</a>
Digital output module instruction manual		

### ▶ CARLO GAVAZZI compatible components

Purpose	Component name/-code	Notes
Power the module via analyzer	WM20 WM30 WM40	The digital output module only works connected to an analyzer. See relevant datasheets.

# Analogue output modules



## Description

Accessory module for WM analyzer family that associates analogue outputs to electrical variables.  
Depending on the version the output range can be set between 0 and 20 mA or 0 and 10 V dc.

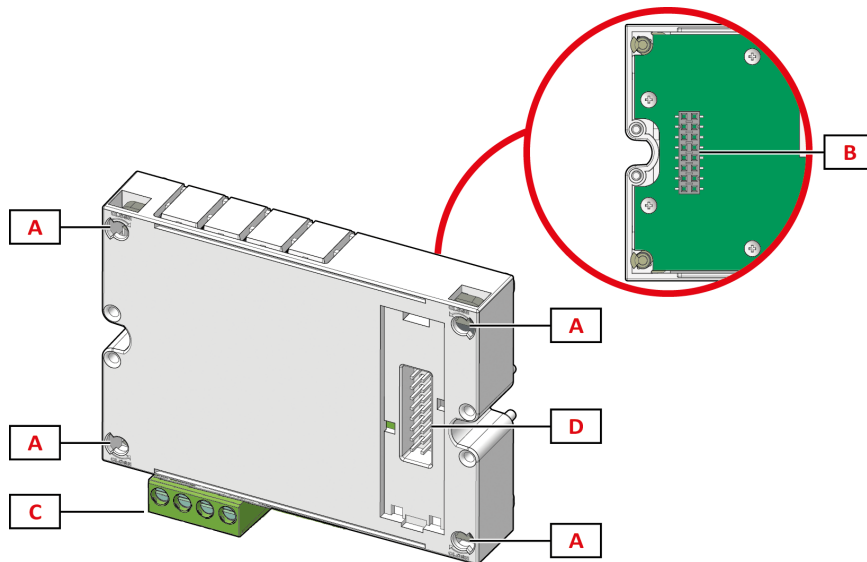
## Main features

- Two analogue outputs (0 to 20 mA or 0 to 10V)
- Configuration via main unit keypad or UCS configuration software
- Easy mounting on main unit
- Detachable terminals
- Local bus connection to main unit

## Main functions

- Associate electrical variables to analogue outputs.

## Structure



**Fig. 21** Front

Element	Description
A	Main unit fastening pins
B	Local bus port for main unit
C	Analogue outputs
D	Local bus port for communication module

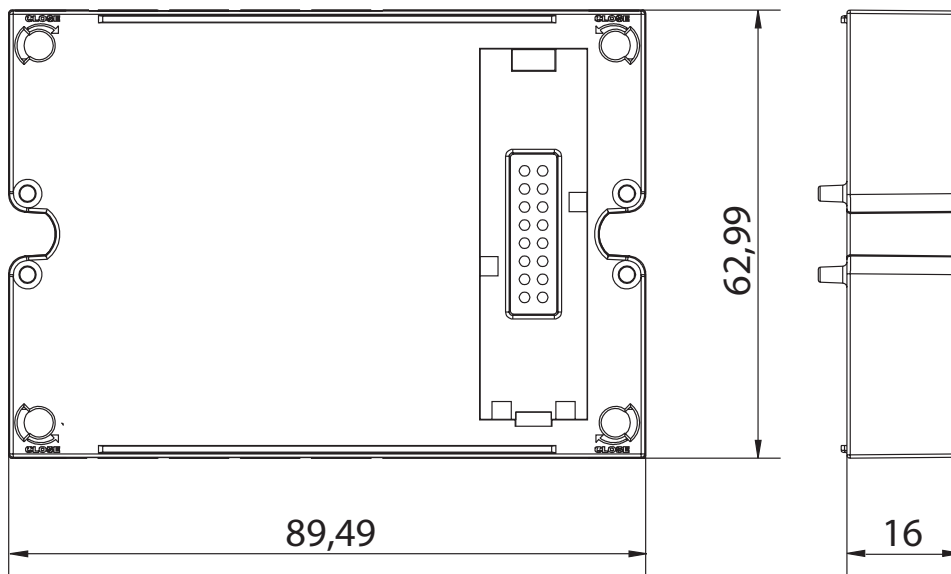
### ▶ Analogue output functions

Analogue outputs can be linked to any electrical variables.

## Features

### General

<b>Mounting</b>	On main unit
<b>Weight</b>	80g
<b>Power supply</b>	Self power supply via local bus



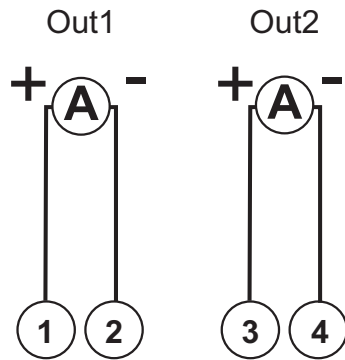
### Analogue output module 0-20mA (M O A2)

<b>Maximum number of outputs</b>	2
<b>Type</b>	0 to 20 mA dc
<b>Accuracy</b>	0.2% FS
<b>Features</b>	Response time $\leq 400$ ms typical (filter excluded) Ripple $\leq 1\%$ (according to IEC 60688-1, EN 60688-1) Total temperature drift $\leq 500$ ppm/ $^{\circ}$ C Load $\leq 600\Omega$
<b>Configuration parameters</b>	Associated electrical variable. Min analogue output (as a percentage of 20mA) Max analogue output (as a percentage of 20mA) Electrical variable value corresponding to min output. Electrical variable value corresponding to max output.
<b>Configuration mode</b>	Via keypad or UCS software

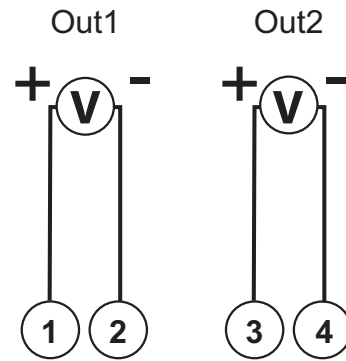
### Analogue output module 0-10V (M O V2)

<b>Maximum number of outputs</b>	2
<b>Type</b>	0 to 10 V dc
<b>Accuracy</b>	0.2% FS
<b>Features</b>	Response time $\leq 400$ ms typical (filter excluded) Ripple $\leq 1\%$ (according to IEC 60688-1, EN 60688-1) Total temperature drift $\leq 350$ ppm/ $^{\circ}$ C Load $\geq 10$ k $\Omega$
<b>Configuration parameters</b>	Associated electrical variable. Min analogue output (as a percentage of 10 V) Max analogue output (as a percentage of 10 V) Electrical variable value corresponding to min output. Electrical variable value corresponding to max output.
<b>Configuration mode</b>	Via keypad or UCS software

## Connection Diagrams



*Fig. 22 MO A2. Double analogue output 0-20mA.*



*Fig. 23 MO V2. Double analogue output 0-10V.*



## References

### Order code

Code	Module description
<b>M O A2</b>	Double analogue output 0-20mA.
<b>M O V2</b>	Double analogue output 0-10V.

### Further reading

Information	Document	Where to find it
WM40 instruction manual	Instruction manual - WM40	<a href="http://www.productselection.net">www.productselection.net</a>
Analogue output module instruction manual		

### CARLO GAVAZZI compatible components

Purpose	Component name/-code	Notes
Power the module via analyzer	WM30 WM40	The digital output module only works connected to an analyzer. See relevant datasheets.

# Digital input/output modules



## Description

Accessory module for WM analyzer family with digital outputs for alarm or pulses transmission and digital outputs for tariff management, DMD synchronization and pulse counting. Each output can run three different functions: alarm, remote control or pulse. Digital inputs can run four different functions: tariff management, remote control, pulse counting (positive/negative active energy, reactive energy, protection trip, water/gas/heating) or remote alarm reset.

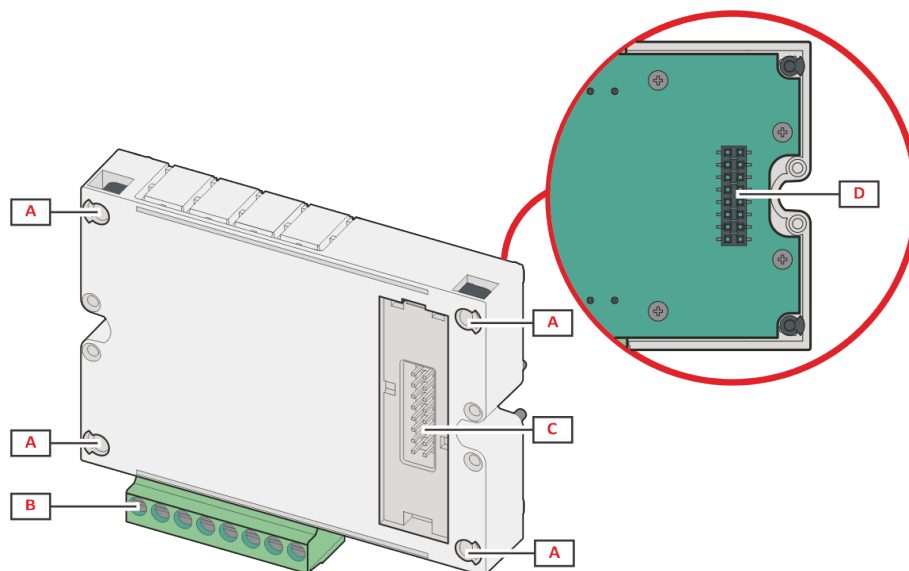
## Main features

- 6 digital inputs
- 4 relay outputs or 6 static outputs
- Configuration via main unit keypad or UCS configuration software
- Easy mounting on main unit
- Detachable terminals
- Local bus connection to main unit

## Main functions

- Transmit pulses with frequency proportional to energy consumption
- Associate alarms to static or relay outputs
- Remote output control
- Tariff management
- Pulse counting
- Remote alarm reset

## Structure

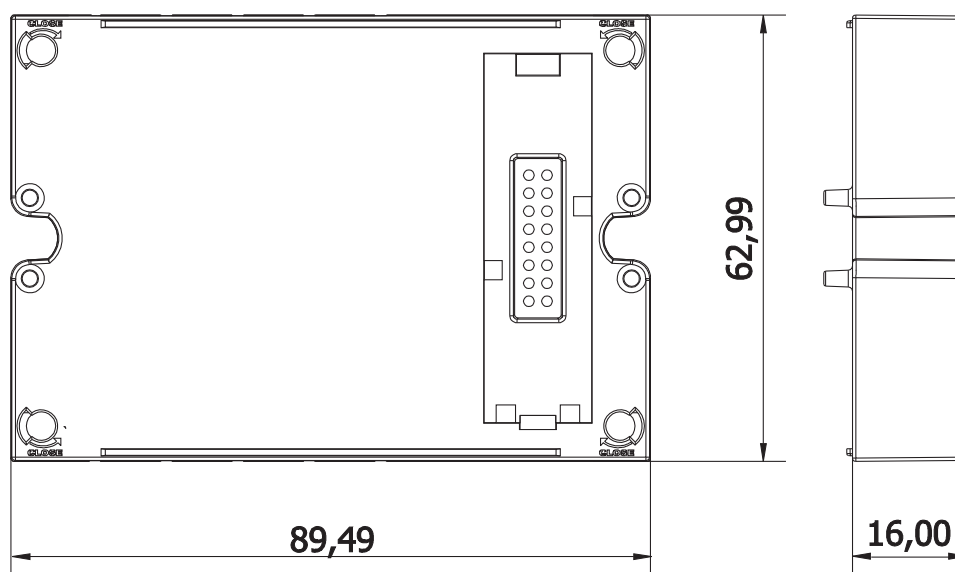


Part	Description
<b>A</b>	Detachable terminal block for inputs/outputs or area specific to communication ports
<b>B</b>	Fastening pins to main unit or other accessory module
<b>C</b>	Internal local bus port for communications with main unit or other accessory module
<b>D</b>	External local bus port for communication with communication module. Not included in communication modules.

## Features

### General

<b>Mounting</b>	On main unit
<b>Weight</b>	80g
<b>Power supply</b>	Self power supply via local bus



### Digital input/static output module (M F I6 O6)

#### Static outputs

<b>Maximum number of outputs</b>	6
<b>Type</b>	Opto-mosfet
<b>Features</b>	$V_{ON}$ : 2.5 V dc, 100 mA max $V_{OFF}$ : 42 V dc max
<b>Functions</b>	Pulse output (kWh+, kWh-, kvarh+ or kvarh-) Alarm output Remote control
<b>Configuration parameters</b>	Function Alarm status Variable Pulse weight
<b>Configuration mode</b>	Via keypad or UCS software

### Digital outputs

<b>Maximum number of outputs</b>	6
<b>Type</b>	voltage-free contacts
<b>Features</b>	20Hz max, duty cycle 50% Open contact voltage: $\leq 3.3$ V dc Closed contact current: $< 1$ mA dc Contact resistance: $\leq 300\Omega$ closed contact, $\geq 50k\Omega$ open contact Input voltage: 0 to 0.5VDC LOW, 2.4 to 25VDC HI
<b>Functions</b>	Status Tariff management (inputs 1,2,3) DMD synchronization (input 1) Water, gas, remote heating pulse counter (inputs 4,5,6) Remote alarm reset (input 4) Protection trip counter (input 4) kWh- pulse counter (input 3) kWh+ pulse counter (input 4) kvarh pulse counter (input 5)
<b>Configuration parameters</b>	Function Pulse weight
<b>Configuration mode</b>	Via keypad or UCS software

### Digital input/ relay output module (M F I6 R4)

#### Relay outputs

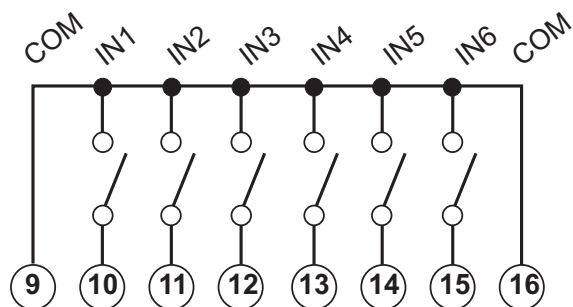
<b>Maximum number of outputs</b>	4
<b>Type</b>	Relay, SPST type
<b>Features</b>	AC1: 5 A @ 250 V ac AC15: 1 A @250 V ac
<b>Functions</b>	Alarm output Remote control
<b>Configuration parameters</b>	Function Alarm status
<b>Configuration mode</b>	Via keypad or UCS software

#### Digital inputs

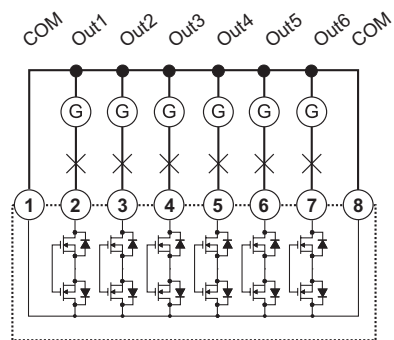
<b>Maximum number of outputs</b>	6
<b>Type</b>	voltage-free contacts

<b>Features</b>	<p>20Hz max, duty cycle 50%</p> <p>Open contact voltage: <math>\leq 3.3</math> V dc</p> <p>Closed contact current: <math>&lt; 1</math> mA dc</p> <p>Contact resistance: <math>\leq 300\Omega</math> closed contact, <math>\geq 50k\Omega</math> open contact</p> <p>Input voltage: 0 to 0.5VDC LOW, 2.4 to 25VDC HI</p>
<b>Functions</b>	<p>Status</p> <p>Tariff management (inputs 1,2,3)</p> <p>DMD synchronization (input 1)</p> <p>Water, gas, remote heating pulse counter (inputs 4,5,6)</p> <p>Remote alarm reset (input 4)</p> <p>Protection trip counter (input 4)</p> <p>kWh- pulse counter (input 3)</p> <p>kWh+ pulse counter (input 4)</p> <p>kvarh pulse counter (input 5)</p>
<b>Configuration parameters</b>	<p>Function</p> <p>Pulse weight</p>
<b>Configuration mode</b>	Via keypad or UCS software

## Connection Diagrams



**Fig. 24** MF 16 O6. 6 digital inputs and 6 static outputs



**Fig. 25** MF 16 R4. 6 digital inputs and 4 relay outputs

## References

### Order code

Code	Module description
<b>MF I6 O6</b>	6 digital inputs and 6 static outputs
<b>MF I6 R4</b>	6 digital inputs and 4 relay outputs

### Further reading

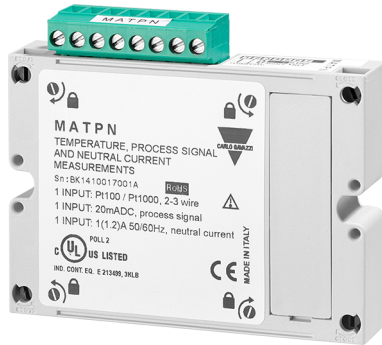
Information	Document	Where to find it
Instruction manual - WM40	Instruction manual - WM40	<a href="http://www.productselection.net">www.productselection.net</a>
Analogue output module instruction manual		

### CARLO GAVAZZI compatible components

Purpose	Component name/-code	Notes
Power the module via analyzer	WM40	The digital output module only works connected to an analyzer. See relevant datasheets.



# Analogue input modules



## Description

Accessory module for WM analyzer family with temperature input (Pt100, Pt1000), analogue input for process signal (-20mA to 20 mA) and real neutral current measuring (by 1A secondary current transformer).

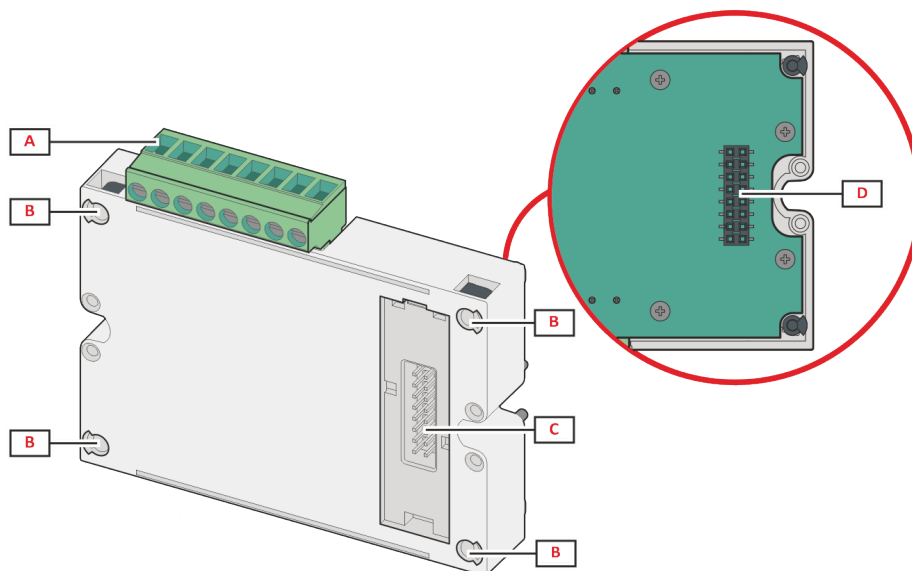
## Main features

- Pt100, Pt1000 temperature input
- Settable temperature measuring unit (°C or °F)
- -20mA to 20mA process signal (analogue input)
- Real neutral current monitoring by 1A secondary CT

## Main functions

- Measure temperature
- Measure process signal (analogue input)
- Real neutral current transformer monitoring (MATPN only)

## Structure



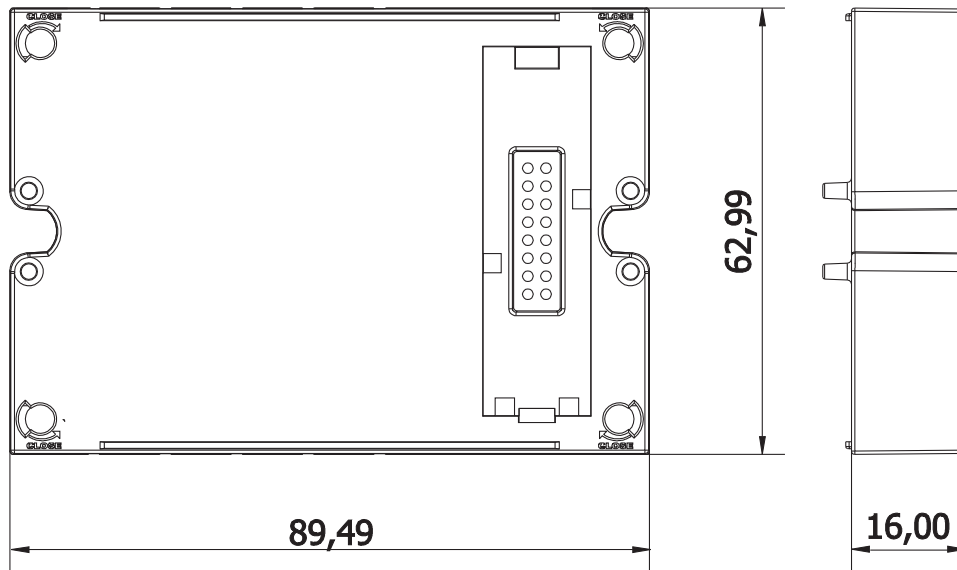
**Fig. 26 Front**

Element	Description
A	Main unit fastening pins
B	Detachable input/output terminals
C	Local bus port for main unit
D	Local bus port for communication module

# Features

## General

<b>Mounting</b>	On main unit
<b>Weight</b>	80g
<b>Power supply</b>	Self power supply via local bus



## Temperature and process signal input (MATP)

### Temperature input

<b>Number of outputs</b>	1
<b>Temperature probe type</b>	Pt100, Pt1000
<b>Features</b>	Number of wires: 2 or 3-wire connection Wire compensation: up to 10Ω
<b>Configuration parameters</b>	Engineering unit Probe type
<b>Configuration mode</b>	Via keypad or UCS software

### Process signal (-20 mA to 20 mA) input

<b>Number of inputs</b>	1
<b>Type</b>	-20mA to +20mA dc

<b>Overload</b>	Continuous: 50mA dc For 1 s.: 150mA dc
<b>Accuracy</b>	from 0% to a 25% FS: $\pm(0,2\%RDG+2DGT)$ from 25% to 110% FS: $\pm(0,1\%RDG+2DGT)$
<b>Features</b>	Temperature drift: $\leq 150\text{ppm}/^{\circ}\text{C}$ Input impedance: $<12\Omega$
<b>Configuration parameters</b>	Min input (mA) Max input (mA) Value corresponding to min input Value corresponding to max input
<b>Configuration mode</b>	Via keypad or UCS software

## Temperature, process signal and neutral current input (MATPN)

### Temperature input

See "Temperature and process signal input (MATP)" on the previous page

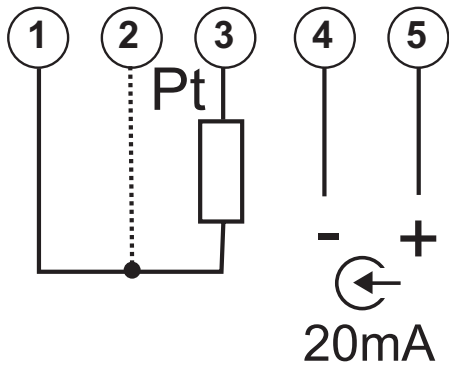
### Process signal (-20 mA to 20 mA) input

See "Temperature and process signal input (MATP)" on the previous page

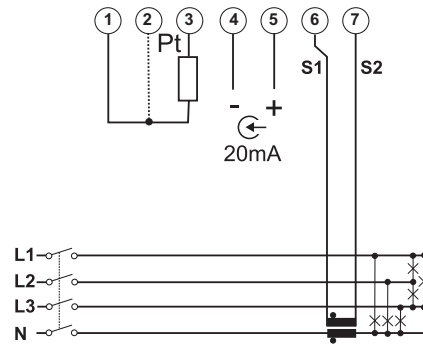
### Neutral current input

<b>Type</b>	1A nominal current (secondary of external current transformer)
<b>Overload</b>	Continuous: 1.2 A For 500 ms: 10 A
<b>Accuracy</b>	From 0.01In to 0.05In: $\pm(0,5\% RDG +2DGT)$ From 0.05In to 1.2In: $\pm(0,2\% RDG +2DGT)$
<b>Features</b>	Temperature drift: $\leq 150\text{ppm}/^{\circ}\text{C}$ Crest factor: $\leq 3$ (3A max. peak) Input impedance: $0.5\Omega$ Frequency: 45 to 65 Hz
<b>Configuration parameters</b>	current transformer ratio (1 to 9999)
<b>Configuration mode</b>	Via keypad or UCS software

## Connection Diagrams



**Fig. 27** MATP.



**Fig. 28** MATPN.

---

## References

### Order code

Code	Module description
<b>MATP</b>	Temperature and process signal input.
<b>MATP N</b>	Temperature, process signal and neutral current input.

### CARLO GAVAZZI compatible components

Purpose	Component name/-code	Notes
Power the module via analyzer	WM40	The digital output module only works connected to an analyzer. See relevant datasheets.

# Communication modules



**Description**

Accessory module for WM analyzer family connected to the main unit that transmits system data remotely using a different communication protocol according to the version. Versions with memory offer data and event log capability.

## Main features

- Supported communication protocols: Modbus, BACnet, Profibus. See "Communication module overview" below
- Configuration via main unit keypad or UCS configuration software
- Easy mounting on main unit
- Local bus connection to main unit

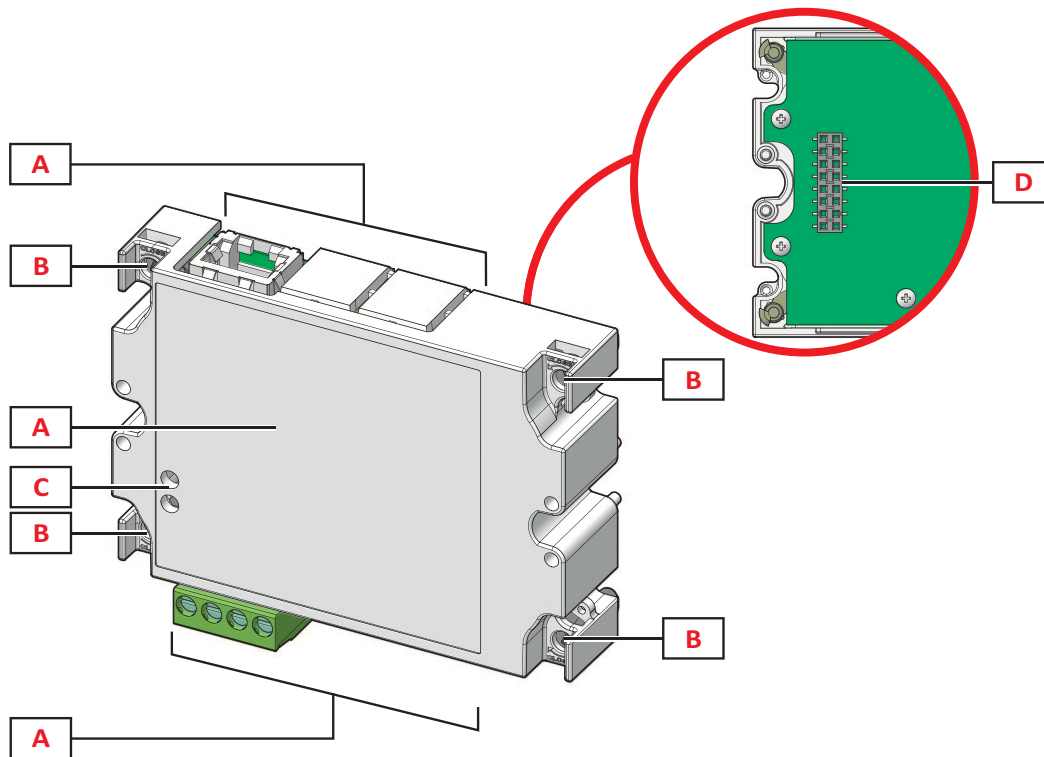
## Main functions

- Transmit data remotely
- Configure the system
- Log data, events, load profile

## Communication module overview

Module code	Memory	Communication protocols	Port
M C 485232	no	Modbus RTU	RS485, RS232
M C 485232 M	yes	Modbus RTU	RS485, RS232
M C ETH	no	Modbus TCP/IP	Ethernet
M C ETH M	yes	Modbus TCP/IP	Ethernet
M C BAC IP	no	BACnet IP, Modbus TCP/IP	Ethernet
M C BAC IP M	yes	BACnet IP, Modbus TCP/IP	Ethernet
M C BAC MS	no	BACnet MS/TP	RS485
		Modbus TCP/IP	Ethernet
M C BAC MS M	yes	BACnet MS/TP	RS485
		Modbus TCP/IP	Ethernet
M C PB	no	Profibus DP V0 slave	RS485
		Modbus RTU	micro USB
M C PB M	yes	Profibus DP V0 slave	RS485
		Modbus RTU	micro USB
M C EI M	yes	Ethernet/IP, Modbus TCP/IP	Ethernet

## Structure



**Fig. 29** Front

**Note:** NOTE: the image refers to the M C BAC MS module.

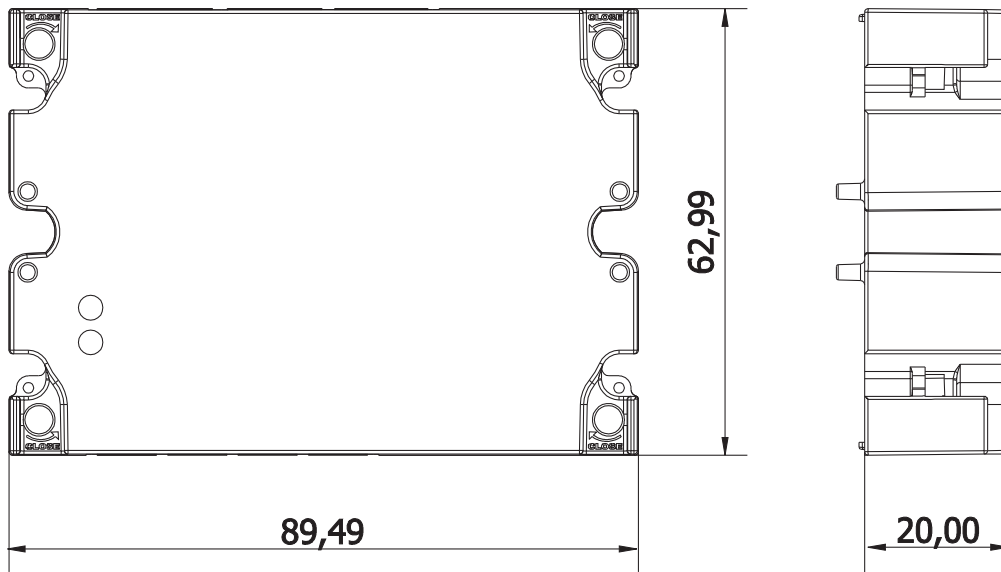
Area	Description
A	Communication port area <b>Note:</b> the communication ports depend on the communication module, see "Communication module overview" on the previous page
B	Main unit fastening pins
C	Communication status LED (M C 485232, M C BAC MS, M C PB)
D	Local bus port for main unit or digital output module



# Features

## General

<b>Mounting</b>	On main unit (with or without digital output module)
<b>Weight</b>	80g
<b>Power supply</b>	Self power supply via local bus



## M C 485232 module

### RS485 port

<b>Protocols</b>	Modbus RTU
<b>Devices on the same bus</b>	Max 160 (1/5 unit load)
<b>Communication type</b>	Multidrop, bidirectional
<b>Connection type</b>	2 wires, maximum distance 1000 m
<b>Configuration parameters</b>	Modbus address (from 1 to 247) Baud rate (9,6/ 19,2/ 38,4/ 115,2 kbps) Parity (None/ Odd/ Even)
<b>Configuration mode</b>	Via keypad or UCS software

### RS232 port

<b>Protocols</b>	Modbus RTU
<b>Communication type</b>	Bidirectional
<b>Connection type</b>	3 wires, maximum distance 15 m

<b>Configuration parameters</b>	Modbus address (from 1 to 247) Baud rate (9,6/ 19,2/ 38,4/ 115,2 kbps) Parity (None/ Odd/ Even)
<b>Configuration mode</b>	Via keypad or UCS software

**Note:** the RS485 and RS232 ports are alternative.

#### LED

<b>Meaning</b>	Communication status: Yellow: receiving Green: transmitting
----------------	---

#### Memory (MC 485232 M only)

See "Memory" on page 53

### M C ETH module

#### Ethernet port

<b>Protocols</b>	Modbus TCP/IP
<b>Client connections</b>	Maximum 5 simultaneously
<b>Connection type</b>	RJ45 connector (10 Base-T, 100 Base-TX), maximum distance 100 m
<b>Configuration parameters</b>	IP address Subnet mask Gateway TCP/IP port
<b>Configuration mode</b>	Via keypad or UCS software

#### Memory (MC 485232 M only)

See "Memory" on page 53

### M C BAC IP module

<b>Ethernet port</b>	
<b>Protocols</b>	BACnet IP (reading) Modbus TCP/IP (reading and configuration)
<b>Client connections</b>	(Modbus only) Maximum 5 simultaneously
<b>Connection type</b>	RJ45 connector (10 Base-T, 100 Base-TX), maximum distance 100 m

Ethernet port	
<b>Configuration parameters</b>	BACnet IP protocol: <ul style="list-style-type: none"> <li>• Instance number (from 0 to 9999 via keypad, from 0 to 4194302 via communication)</li> <li>• Foreign Device enabling</li> <li>• BBMD address</li> <li>• UDP port</li> <li>• WM40 time-to-live recording as Foreign Device on specified BBMD server</li> </ul> Modbus TCP/IP protocol: <ul style="list-style-type: none"> <li>• IP address</li> <li>• Subnet mask</li> <li>• Gateway</li> <li>• TCP/IP port</li> </ul>
<b>Supported services</b>	"I-have", "I-am", "Who-has", "Who-is", "Read-property (multiple)"
<b>Supported objects</b>	Type 2 (analogue value including COV property), type 5 (binary value, for alarm transmission), type 8 (device)
<b>Configuration mode</b>	Via keypad or UCS software

### Memory (MC 485232 M only)

See "Memory" on page 53

## M C BAC MS module

### RS485 port

<b>Protocols</b>	BACnet MS/TP (measurement reading and object description writing)
<b>Communication type</b>	Multidrop, monodirectional
<b>Connection type</b>	2 wires, maximum distance 1000 m
<b>Supported services</b>	"I-have", "I-am", "Who-has", "Who-is", "Read-property (multiple)"
<b>Supported objects</b>	Type 2 (analogue value including COV property), type 5 (binary value, for alarm transmission), type 8 (device)
<b>Configuration parameters</b>	BACnet IP protocol: <ul style="list-style-type: none"> <li>• Instance number (from 0 to 9999 via keypad, from 0 to 4194302 via communication)</li> <li>• Baud rate (9,6/ 19,2/ 38,4/ 57,6/ 76,8 kbps)</li> <li>• MAC address (from 0 to 127)</li> </ul>
<b>Configuration mode</b>	Via keypad or UCS software

### Ethernet port

<b>Protocols</b>	Modbus TCP/IP (configuration)
<b>Client connections</b>	(Modbus only) Maximum 5 simultaneously
<b>Connection type</b>	RJ45 connector (10 Base-T, 100 Base-TX), maximum distance 100 m

<b>Configuration parameters</b>	IP address Subnet mask Gateway TCP/IP port
<b>Configuration mode</b>	Via keypad or UCS software

#### LED

<b>Meaning</b>	Communication status: Yellow: receiving Green: transmitting
----------------	---

#### Memory (MC 485232 M only)

See "Memory" on the next page

### M C PB module

#### Profibus port

<b>Protocols</b>	Profibus DP V0 slave
<b>Connection type</b>	9-pin D-sub receptacle RS485
<b>Configuration parameters</b>	Address, via keypad Other settings with UCS software via serial communication
<b>Configuration mode</b>	Via keypad or UCS software

#### Micro-USB port

<b>Protocols</b>	Modbus RTU
<b>Type</b>	USB 2.0 (USB 3.0 compatible)
<b>Connection type</b>	Micro-USB B
<b>Baud rate</b>	Any (maximum 115.2 kbps)
<b>Address</b>	1

#### LED

<b>Meaning</b>	Communication status: Red: between module and main unit Green: between module and Profibus master
----------------	---

#### Memory (MC 485232 M only)

See "Memory" on the next page

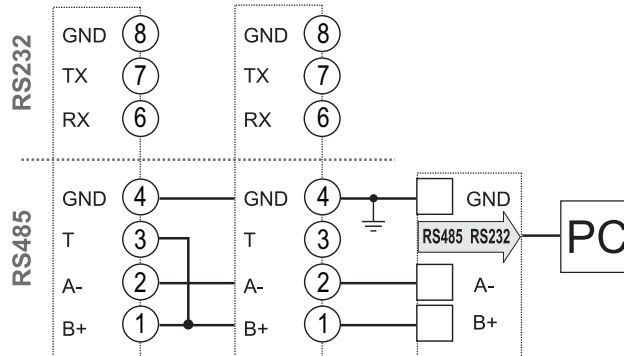
## Memory

Event log	
Type of data	Alarm, min, max, digital input status, digital output status as remote control, resets.
Stamping format	Date (dd:MM:yy) and hour (hh:mm:ss) reference.
Number of events	Up to 10,000
Data management type	FIFO
Configuration parameters	Enabling Storage interval Events Reset database
Configuration mode	Via UCS software

Electrical variables datalog	
Type of data	Minimum/maximum/average values in each time interval of any measured variable.
Stamping format	Date (dd:MM:yy) and hour (hh:mm:ss) reference.
Number of variables	Up to 19
Time interval	From 1 minute up to 60 minutes.
Data management type	FIFO
Configuration parameters	Enabling Storage interval Variables Reset database
Configuration mode	Via UCS software

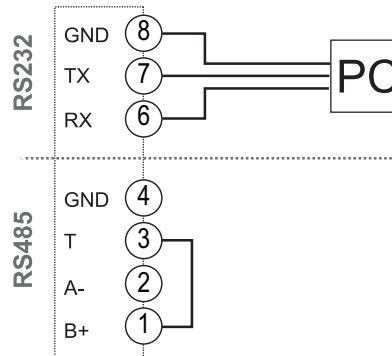
Load profile datalog	
Type of data	average values in each time interval of active or reactive power
Stamping format	Date (dd:MM:yy) and hour (hh:mm:ss) reference.
Number of variables	1
Time interval	From 1 minute up to 60 minutes.
Data management type	FIFO
Configuration parameters	Enabling Storage interval Active or apparent power Reset database
Configuration mode	Via UCS software

## Connection Diagrams

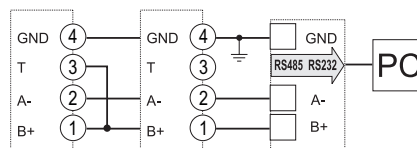


**Fig. 30** M C 485232. RS485 serial port.

**Note:** additional meters with RS485 are connected in daisy chain. The serial output must only be terminated on the last network meter connecting terminals B+ and T.



**Fig. 31** M C 485232. RS232 serial port.



**Fig. 32** M C BAC MS. RS485 serial port.

**Note:** additional meters with RS485 are connected in daisy chain. The serial output must only be terminated on the last network meter connecting terminals B+ and T.

## References

### Order code

Code	Module description
<b>MC 485232</b>	Modbus RTU communication on RS485/RS232
<b>MC 485232 M</b>	Modbus RTU communication on RS485/RS232+ memory
<b>MC ETH</b>	Modbus TCP/IP communication on Ethernet
<b>MC ETH M</b>	Modbus TCP/IP communication on Ethernet+ memory
<b>MC BAC IP</b>	BACnet IP communication on Ethernet
<b>MC BAC IP M</b>	BACnet IP communication on Ethernet + memory
<b>MC BAC MS</b>	BACnet MS/TP communication on RS485
<b>MC BAC MS M</b>	BACnet MS/TP communication on RS485+ memory
<b>MC PB</b>	Profibus DP V0 communication on RS485
<b>MC PB M</b>	Profibus DP V0 communication on RS485+ memory
<b>MC EI</b>	Ethernet/IP communication on Ethernet
<b>MC EI M</b>	Ethernet/IP communication on Ethernet+ memory

### Further reading

Information	Document	Where to find it
WM40 instruction manual	Instruction manual - WM40	<a href="http://www.productselection.net">www.productselection.net</a>
Communication module instruction manual (M C 485232, M C ETH, M C BAC IP, M C BAC MS)		
Communication module instruction manual (M C PB)		

### CARLO GAVAZZI compatible components

Purpose	Component name/-code	Notes
Power the module via analyzer	WM20 WM30 WM40	The communication module only works connected to an analyzer. See relevant datasheets.



COPYRIGHT ©2022

Content subject to change. Download the PDF: [www.gavazziautomation.com](http://www.gavazziautomation.com)