

DEBIX Model B

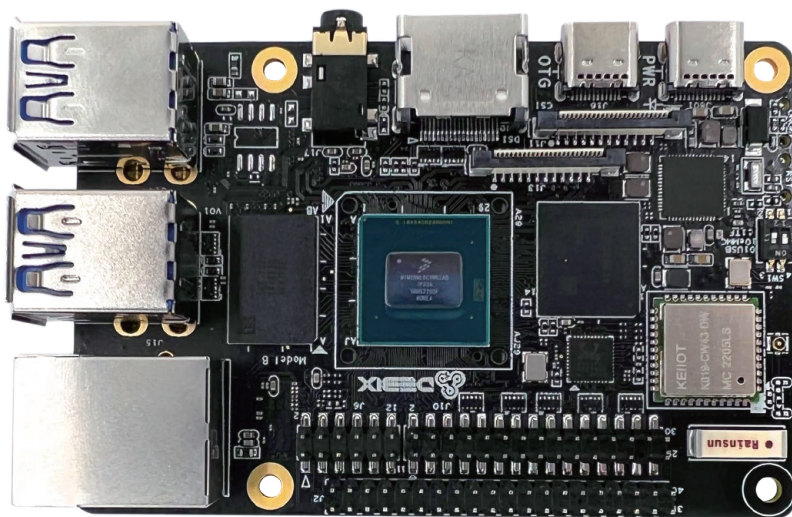



DEBIX Model B Industrial Single Board Computer

Overview:

DEBIX Model B and DEBIX Model A utilizes the same CPU (i.MX 8M Plus with 2.3TOPS NPU) and PCB design, so we can see where they get their similar appearance from, they also have the same type and number of interfaces. The only difference is that the guaranteed operating temperature range of DEBIX Model A is $-20^{\circ}\text{C} \sim 75^{\circ}\text{C}$, while DEBIX Model B is fully capable of operating at $-40^{\circ}\text{C} \sim 85^{\circ}\text{C}$ after we upgraded individual chips and components on the board.

The reason why we launched DEBIX Model B instead of directly upgrading DEBIX Model A is to make it convenient for customers to choose a board according to the temperatures of their real-world application environment.

Main Features:

- High industrial reliability and a guaranteed operating temperature of $-40^{\circ}\text{C} \sim 85^{\circ}\text{C}$ for extreme environment
- Support Android 11, Yocto-L5.10.72_2.2.0, Ubuntu 20.04 and Windows 10 IoT Enterprise operating system
- Gigabit network, 2.4GHz & 5GHz Wifi, Bluetooth 5.0, high-speed USB 3.0 and PCIe support connection and control of a variety of industrial peripherals
- Advanced multimedia capabilities include 1080p60 video encode and decode (including H.265, H.264), 3D/2D graphic acceleration, and multiple audio and voice functionalities

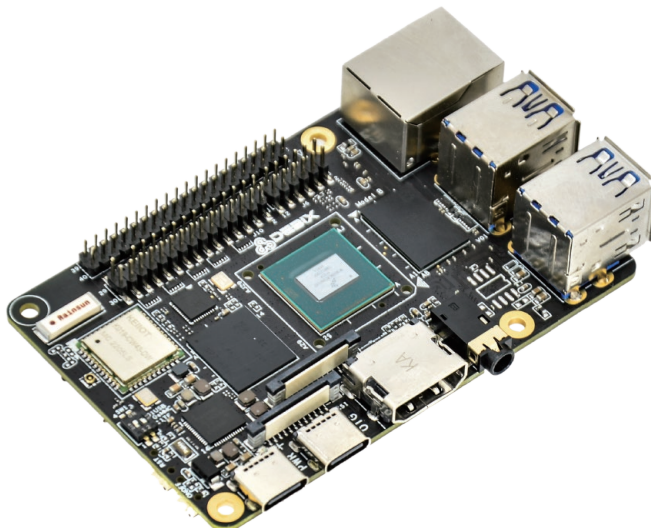

Specification:

System	
CPU	NXP i.MX 8M Plus (default), 4 x ARM Cortex-A53, comes with an integrated neural processing unit (NPU) that delivers up to 2.3 TOPS. Industrial grade CPU runs at 1.6GHz, and commercial grade CPU runs at up to 1.8GHz. (i.MX 8M Plus series CPU optional)
Memory	2GB LPDDR4 (4GB/6GB optional)
Storage	Default: Micro SD card (Onboard 8GB/16GB/32GB/64GB eMMC optional)
Operating System	Android 11, Yocto-L5.10.72_2.2.0, Ubuntu 20.04, Windows 10 IoT Enterprise
I/O Interfaces	
Gigabit Ethernet	1 x RJ45 with POE power supply (need POE power device module) 1 x pin header (without network transformer)
WIFI & BT	2.4GHz & 5GHz WIFI, BT5.0
USB	4 x USB 3.0 Host Type-A, 1 x USB 2.0 OTG Type-C
Audio	1 x Headphone and Mic combo port
HDMI	1 x HDMI OUT
Expansion	
40-Pin Double-Row Headers	(1) 3 x UART, 2 x I2C, 2 x SPI, 2 x CAN, 6 x GPIO for default, can be reused as I2S, PWM, SPDIF and GPIO through software configuration. (2) 5V power supply, system reset, ON/OFF
LVDS	1 x LVDS, single & dual channel 8bit, double-row pin headers
MIPI CSI	1 x MIPI CSI, support 4-lane 24-Pin 0.5mm Pitch FPC socket
MIPI DSI	1 x MIPI DSI, support 4-lane 24-Pin 0.5mm Pitch FPC socket
PCIe	1 x PCIe, support PCIe x1, 19-Pin 0.3mm Pitch FPC socket
Power Supply	
Power Supply	DC 5V/3A Type-C
Mechanical & Environmental	
Size	85.0mm x 56.0mm
Operating Temp.	-40°C to 85°C

I/O Interfaces:

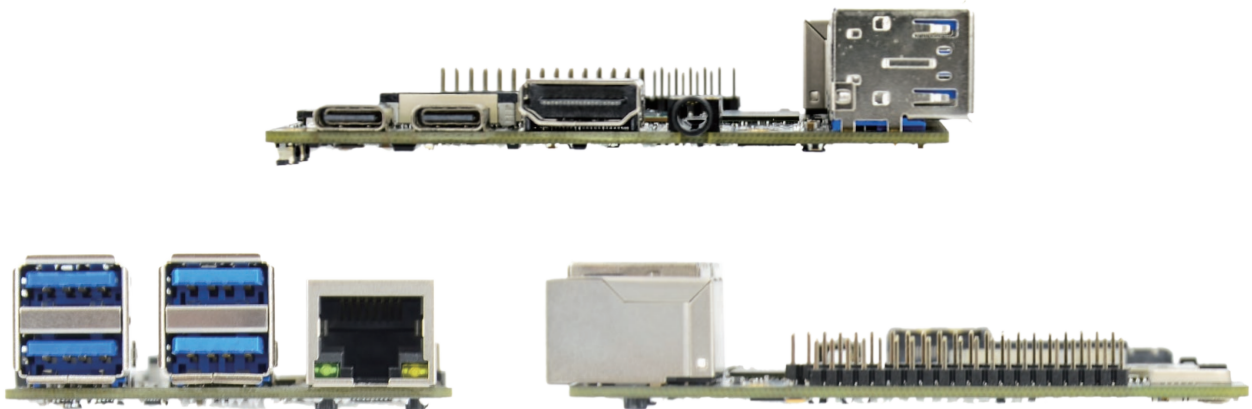
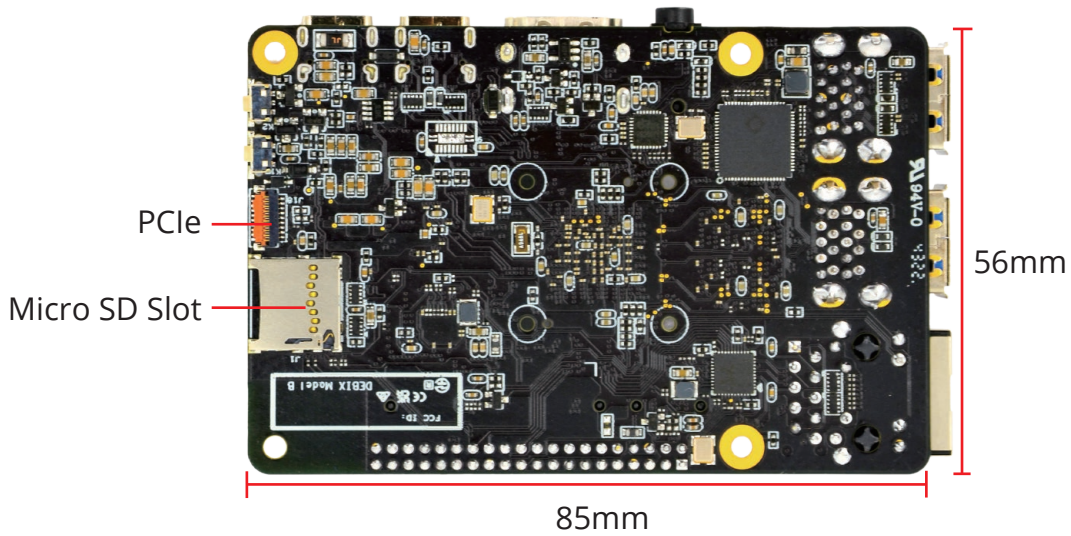
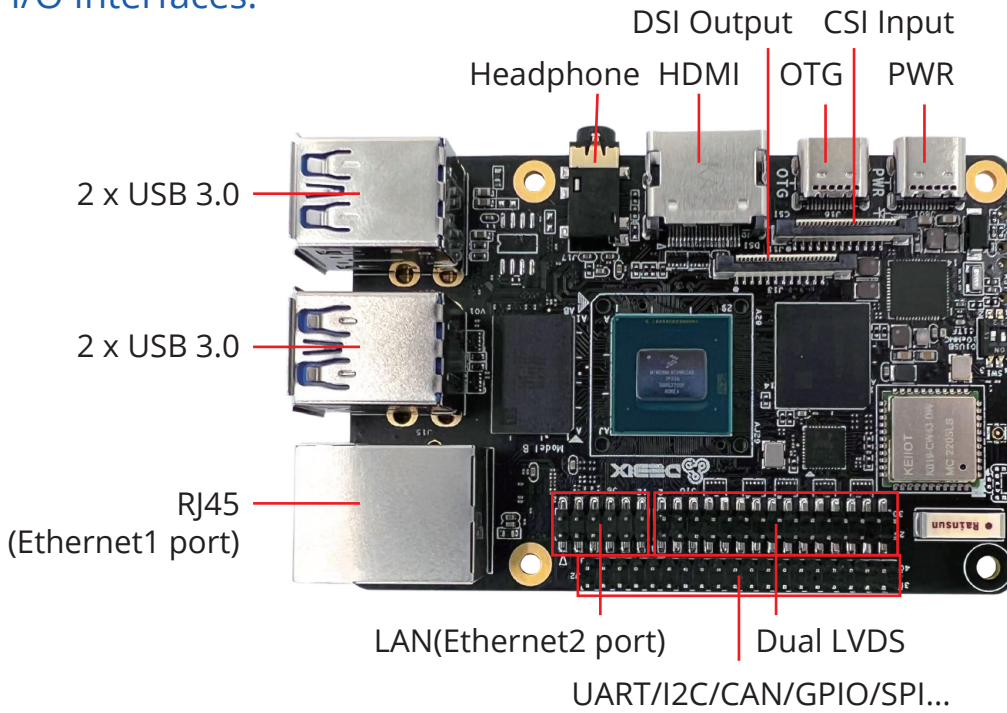

Safety Instruction:

To avoid malfunction or damage to this product please observe the following:

- Do not expose to water, moisture or place on a conductive surface whilst in operation.
- Take care while handling to avoid mechanical or electrical damage to the printed circuit board and connectors.
- Avoid handling the printed circuit board whilst it is powered and only handle by the edges to minimize the risk of electrostatic discharge damage.

Warnings:

- This product should only be connected to an external power supply rated at 5V/3A DC minimum. Any external power supply used with DEBIX Model B shall comply with relevant regulations and standards applicable in the country of intended use.
- This product should be operated in a well-ventilated environment and, if used inside a case, the case should not be covered.
- This product should be placed on a stable, flat, non-conductive surface in use and should not be contacted by conductive items.
- The connection of incompatible devices to the GPIO connection may affect compliance and result in damage to the unit and invalidate the warranty.
- All peripherals used with this product should comply with relevant standards for the country of use and be marked accordingly to ensure that safety and performance requirements are met. These articles include but are not limited to keyboards, monitors and mice when used in conjunction with DEBIX.
- Where peripherals are connected that do not include the cable or connector, the cable or connector must offer adequate insulation and operation in order that the relevant performance and safety requirements are met.

Contact Us:

OKdo Technology Limited

Address: Fifth Floor, Two Pancras Square, Kings Cross, London N1C 4AG

Telephone: +44(0)203 109 0210

Email: sales@okdo.com; support@okdo.com

Website: www.OKdo.com