

03 WKV

Circular connectors with threaded joint M16 acc. to IEC 61076-2-106, IP40/IP68



Socket acc. to IEC 61076-2-106, IP40, angular version, with threaded joint, solder terminals and bend protection, for cable diameter up to 6 mm

03 WKV

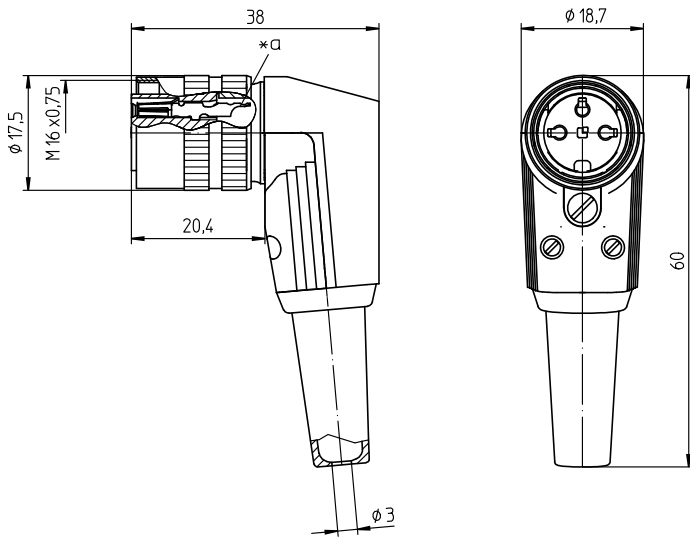

Environmental conditions

Temperature range -40 °C/+85 °C

Materials

Insulating body	PA GF, V-0 according to UL94
Contact bush	CuZn, silver-plated and flash gold-plated (3-8 poles) CuZn, pre-nickel and gold-plated (12 poles)
Ground contact spring	CuZn, pre-nickel and tin-plated
Sleeve	steel, zinc-plated
Strain relief	steel, nickel-plated
Housing	PC, HB according to UL94
Knurled nut	CuZn, nickel-plated
Bend protection sleeve	TPE
Screw	special steel/steel chromatiert

Pin configurations, solder side view

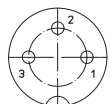

03-a
WKV 30

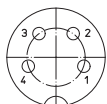

04-a
WKV 40

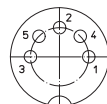

05-b
WKV 50



05-a
WKV 50/6



06-a
WKV 60

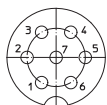

07-a
WKV 70

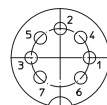

07-b
WKV 71

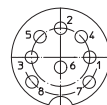

WKV 80



08-a
WKV 81



12-a
WKV 120

*a cup-shaped solder terminal

Mechanical data

Insertion force/contact	≤ 5.0 N ¹
Withdrawal force/contact	≥ 1.2 N (3-8 poles) ≥ 0.9 N (12 poles) ¹
Tightening torque connector	1–3 Nm
Protection class	IP40 ²

¹ measured with a polished steel pin, nominal thickness 1.5 mm (1.0 mm with 12 poles)
² according to IEC DIN EN 60529, only in locked condition with an appropriate counterpart

Connectable conductors for solder area

Section	≤ 0.75 mm ² (AWG 20) (3-8 poles) ≤ 0.25 mm ² (AWG 24) (12 poles)
Cable diameter	4–6 mm

Electrical data (at T_{amb} 20 °C)

Contact resistance	≤ 5 mΩ
Rated current	5 A (T _{amb} 40 °C, 3-8 poles) 3 A (T _{amb} 40 °C, 12 poles)
Rated voltage	with pollution degree 1: 300 V (versions 30, 40, 50/6, 60, 70) 100 V (versions 50, 71, 80, 81) 160 V (Polbild 120) with pollution degree 2: 250 V (versions 30, 40) 32 V (versions 50, 71, 80, 81) 160 V (versions 50/6, 60, 70, 120)
Rated impulse voltage	1500 V (versions 30, 40, 50/6, 60, 70, 120) 500 V (versions 50, 71, 80, 81)
Material group	II (IEC)/1 (UL) (400 = CTI < 600)
Overvoltage category	I
Insulation resistance	> 100 MΩ

Associated products

Counterparts

☞ SFV	☞ SFV ... C	☞ SGR
☞ SGV	☞ SGV ... C	☞ SV
☞ SV ... C	☞ SV ...-8	☞ SV ...-8 C
☞ WSV	☞ WSV ... C	

Accessories

☞ 0381	☞ 038199	☞ 038799
------------------------	--------------------------	--------------------------

03 WKV

Designation	Pole Number	PU (Pieces)	MDQ (Pieces)
WKV 30	3	50	100
WKV 40	4	50	100
WKV 50	5	50	100
WKV 50/6	5	50	100
WKV 60	6	50	100
WKV 70	7	50	100
WKV 71	7	50	100
WKV 80	8	50	100
WKV 81	8	50	100
WKV 120	12	50	100

Packaging:

pre-assembled, in a cardboard box