

03 0306

Circular connectors with threaded joint M16 acc. to IEC 61076-2-106, IP40/IP68



Chassis socket acc. to IEC 61076-2-106, IP68, with threaded joint, for printed circuit boards, for front mounting

03 0306

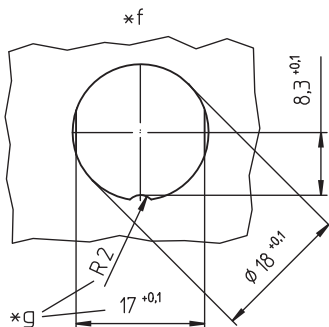
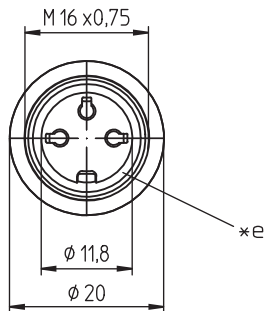
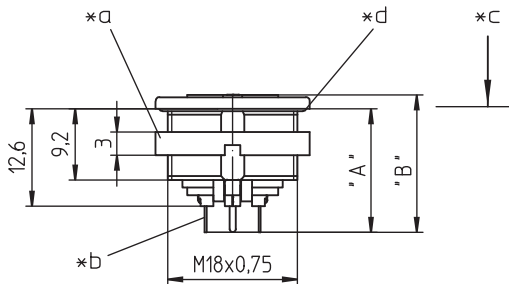
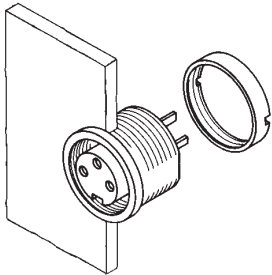

Environmental conditions

Temperature range -40 °C/+85 °C

Materials

Insulating body	PA GF, V-0 according to UL94
Contact bush	CuZn, silver-plated and flash gold-plated, tin-plated in solder area (3-8 poles) CuZn, pre-nickel and gold-plated, tin-plated in solder area (12-14 poles)
Housing	Zn diecast, pre-copper and nickel-plated
Ring screw	CuZn, nickel-plated
Seal	CR (flat), NBR (O-ring)

Mechanical data

Insertion force/contact	$\leq 5.0 \text{ N}^1$
Withdrawal force/contact	$\geq 1.2 \text{ N}$ (3-8 poles) $\geq 0.9 \text{ N}$ (12-14 poles) ¹
Tightening torque connector	1-3 Nm
Tightening torque nut	1-3 Nm
Protection class	IP68 ²

¹ measured with a polished steel pin, nominal thickness 1.5 mm (1.0 mm with 12-14 poles)

² according to IEC DIN EN 60529, only in locked condition with an appropriate counterpart; IPX8 requirements under agreement between manufacturer and user

Electrical data (at $T_{\text{amb}} 20 \text{ }^\circ\text{C}$)

Contact resistance	$\leq 5 \text{ m}\Omega$
Rated current	5 A ($T_{\text{amb}} 40 \text{ }^\circ\text{C}$, 3-8 poles) 3 A ($T_{\text{amb}} 40 \text{ }^\circ\text{C}$, 12-14 poles)
Rated voltage	with pollution degree 1: 300 V (versions 03, 04, 05-1, 06, 07) 100 V (versions 05, 07-1, 08, 08-1) 160 V (versions 12, 14) with pollution degree 2: 250 V (versions 03, 04) 32 V (versions 05, 07-1, 08, 08-1) 160 V (versions 05-1, 06, 07, 12, 14)
Rated impulse voltage	1500 V (versions 03, 04, 05-1, 06, 07, 12, 14) 500 V (versions 05, 07-1, 08, 08-1)
Material group	II (IEC)/I (UL) (400 \leq CTI < 600)
Overvoltage category	I
Insulation resistance	> 100 M Ω

03 0306

Pin configurations, solder side view

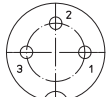

03-a
0306 03



04-a
0306 04

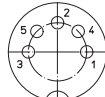

05-b
0306 05



05-a
0306 05-1

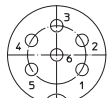

06-a
0306 06



07-a
0306 07

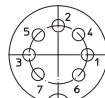

07-b
0306 07-1

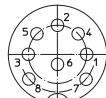

0306 08



08-a
0306 08-1









12-a
0306 12









14-a
0306 14

Associated products

Counterparts

- | | | |
|--|--|--|
|  0331 |  0332 |  0332-1 |
|  033200 |  0365 |  036500 |

Accessories

- | | | |
|---|--|--|
|  0322 C 16 |  0381 |  038199 |
|  0382 |  0384 |  0385 |
|  038799 | | |

03 0306

Printed circuit board layout, solder side view

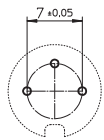

03-a
0306 03

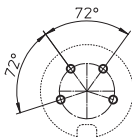

04-a
0306 04

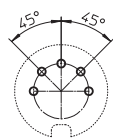

05-b
0306 05

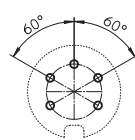

05-a
0306 05-1

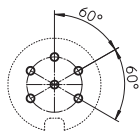

06-a
0306 06

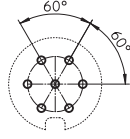

07-a
0306 07

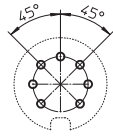

07-b
0306 07-1

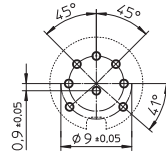

0306 08

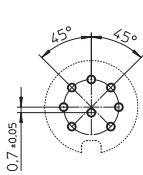

08-a
0306 08-1

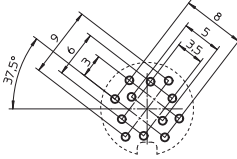

12-a
0306 12

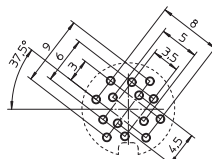

14-a
0306 14

- *a nut enclosed separately
- *b for bore hole of PCB
Ø 1,0 mm (0306 03–0306 08-1)
Ø 0,7 mm (0306 12–0306 14)
- *c mounting direction
- *d O-ring gasket
- *e flat gasket
- *f port in mounting plate
- *g anti-rotation, alternative execution

03 0306

Designation	Pole Number	PU (Pieces)	MDQ (Pieces)	Dimensions	
				A (mm)	B (mm)
0306 03	3	50	100	16.0	17.8
0306 04	4	50	100	16.0	17.8
0306 05	5	50	100	16.0	17.8
0306 05-1	5	50	100	16.0	17.8
0306 06	6	50	100	16.0	17.8
0306 07	7	50	100	16.0	17.8
0306 07-1	7	50	100	16.0	17.8
0306 08	8	50	100	16.0	17.8
0306 08-1	8	50	100	16.0	17.8
0306 12	12	50	100	15.6	17.1
0306 14	14	50	100	15.6	17.1

Packaging:
in a cardboard box