

**PLUG MATED TO R/A RECEPTACLE  
MATED PROFILE**

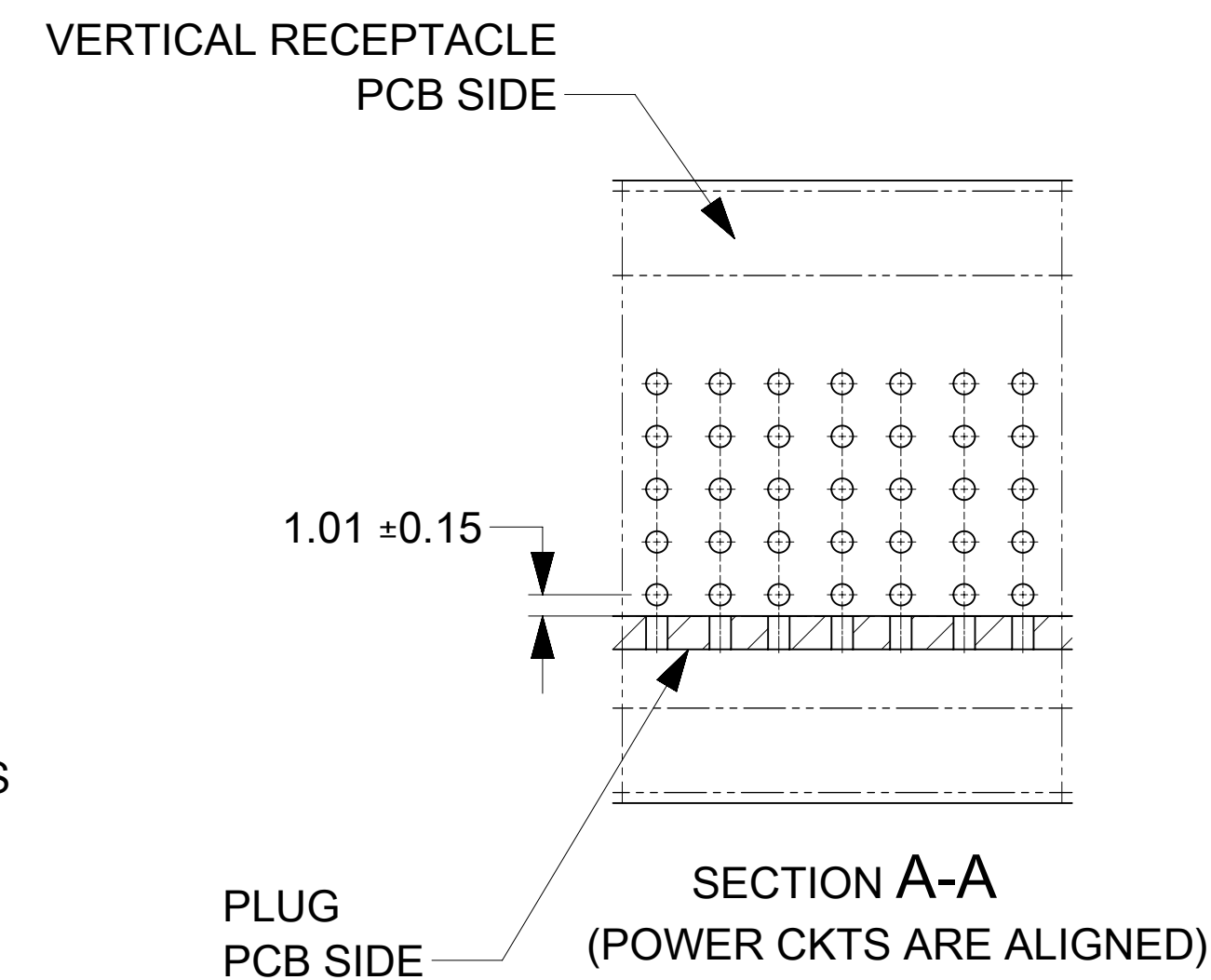

**PLUG MATED TO VERTICAL RECEPTACLE  
MATED PROFILE**

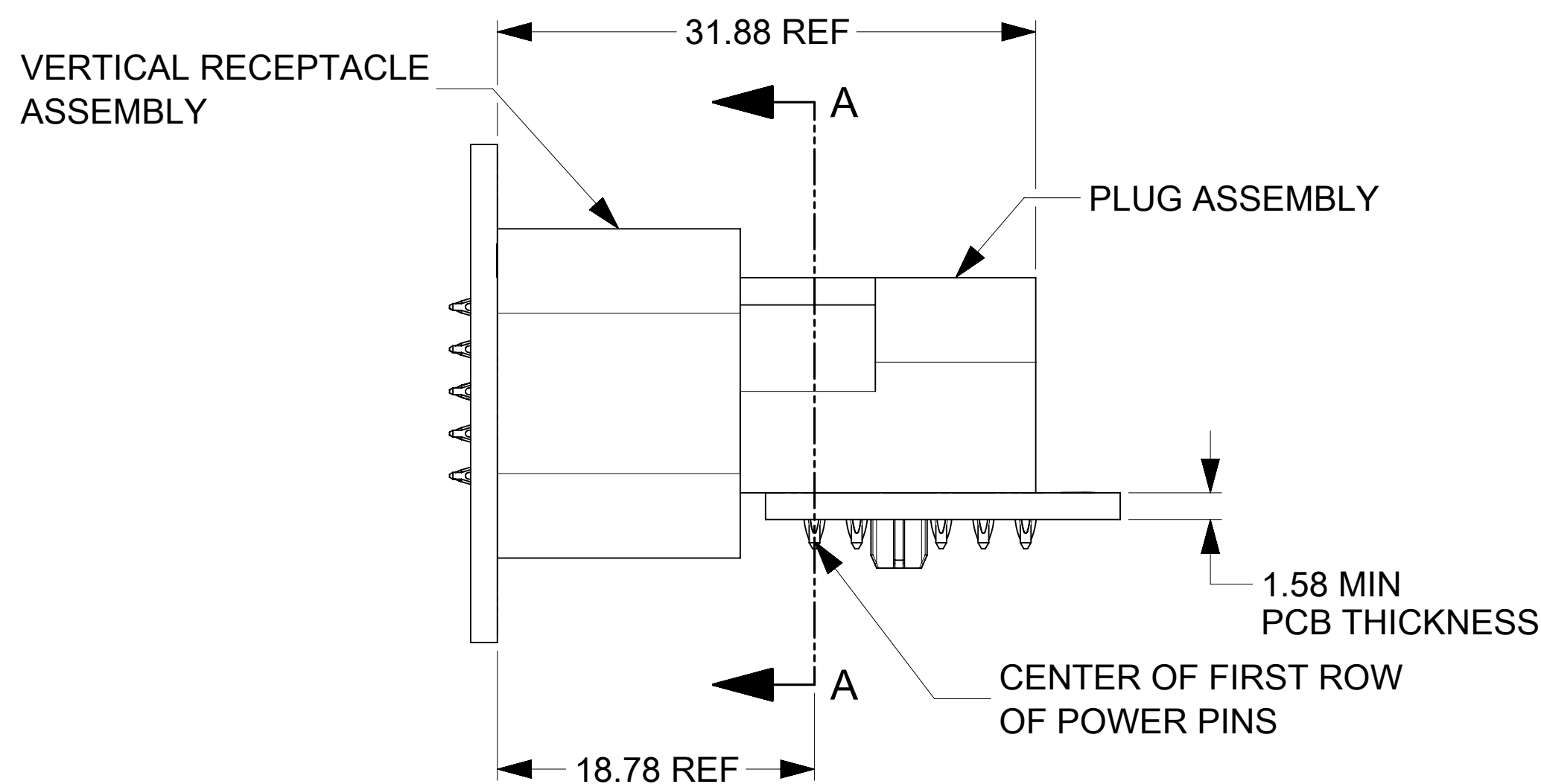
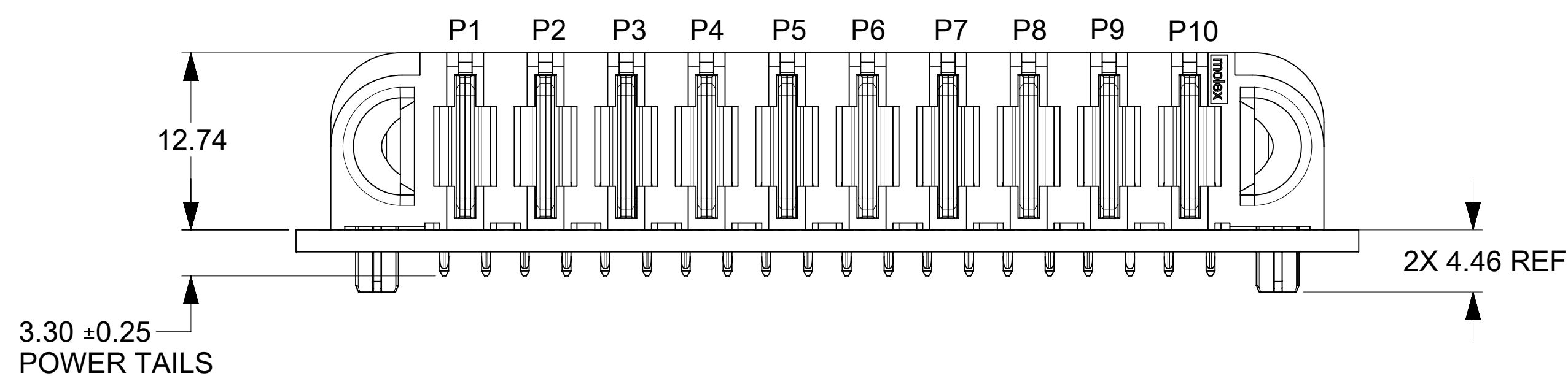
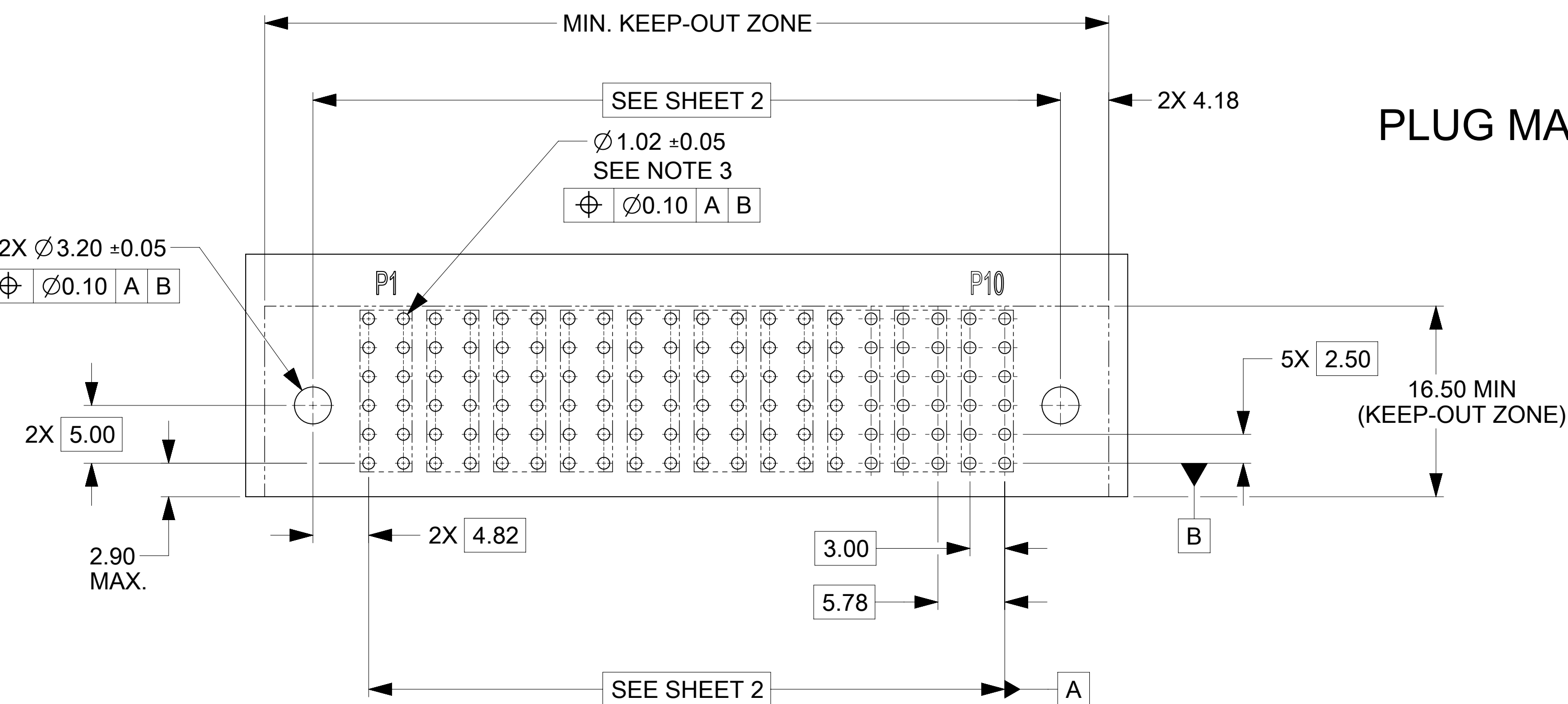

**NOTES:**

- MATERIAL:**  
 -HOUSINGS: LCP UL94, V-0, COLOR : BLACK  
 -TERMINALS: HIGH CONDUCTIVITY COPPER ALLOY  
 -PLATING: 1.27 µm (50 µin) NICKEL OVERALL WITH  
 2.54 µm (100 µin) SELECTIVE TIN ON TAILS AND  
 0.762 µm (30 µin) SELECTIVE GOLD ON CONTACT AREA
- PACKAGING:** ASSEMBLIES TO BE TRAY PACKED PER PACKAGING SPEC: 2141130010-PK.
- PLATED THRU HOLE SIZE,** REFER TO PRODUCT SPEC. FOR DETAILS.
- PRODUCT SPEC:** 2141130000-PS.
- PRODUCT TO MEET** RoHS REQUIREMENTS.
- PLUG ASSEMBLY MATES TO MOLEX RECEPTACLES** 219563XXXX-SD AND 219564XXXX-SD, SEE DRAWINGS FOR DETAILS.
- TAIL DESIGN:** COMPLIANT PIN.
- POWER TERMINALS ARE LUBRICATED.**
- APPLICATION SPECIFICATION:** 2141130000-AS (FOR COMPLIANT TAILS ONLY).

**RECOMMENDED PCB LAYOUT AND KEEP-OUT ZONE**

THIS DRAWING CONTAINS INFORMATION THAT IS PROPRIETARY TO MOLEX ELECTRONIC TECHNOLOGIES, LLC AND SHOULD NOT BE USED WITHOUT WRITTEN PERMISSION									
DIMENSION UNITS		SCALE		CURRENT REV DESC:					
mm		3:1							
GENERAL TOLERANCES (UNLESS SPECIFIED)									
ANGULAR TOL ± °									
4 PLACES		±		EC NO: 745288					
3 PLACES		±		DRWN: LZABJANOVSKI		2023/03/09			
2 PLACES		± 0.25		CHK'D: JAYK1		2023/04/10			
1 PLACE		± 0.3		APPR: JAYK1		2023/04/10			
0 PLACES		±		INITIAL REVISION:					
				DRWN: LZABJANOVSKI		2022/03/14			
				APPR: BPISZCZOR		2022/08/04			
DRAFT WHERE APPLICABLE MUST REMAIN WITHIN DIMENSIONS				THIRD ANGLE PROJECTION		DRAWING		SERIES	
				D-SIZE		219562		MATERIAL NUMBER	
						SEE CHART		CUSTOMER	
								SHEET NUMBER	
								1 OF 2	



GUARDIAN HD RA PLUG POWER ONLY PF

PRODUCT CUSTOMER DRAWING

DOCUMENT NUMBER	DOC TYPE	DOC PART	REVISION
2195629000-SD	PSD	000	A1

PART NUMBER	CONFIGURATION	QUANTITY PER CARTON (DU)
219562-0001	G+1P+G	195

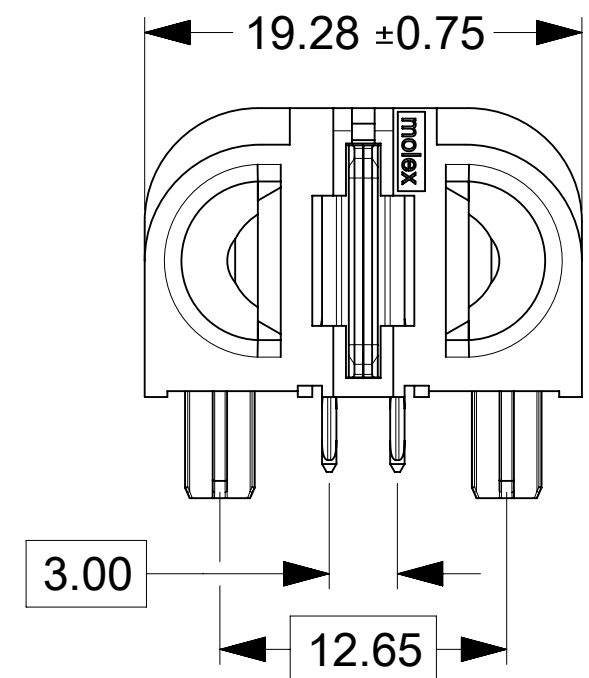

PART NUMBER	CONFIGURATION	QUANTITY PER CARTON (DU)
219562-0002	G+2P+G	150

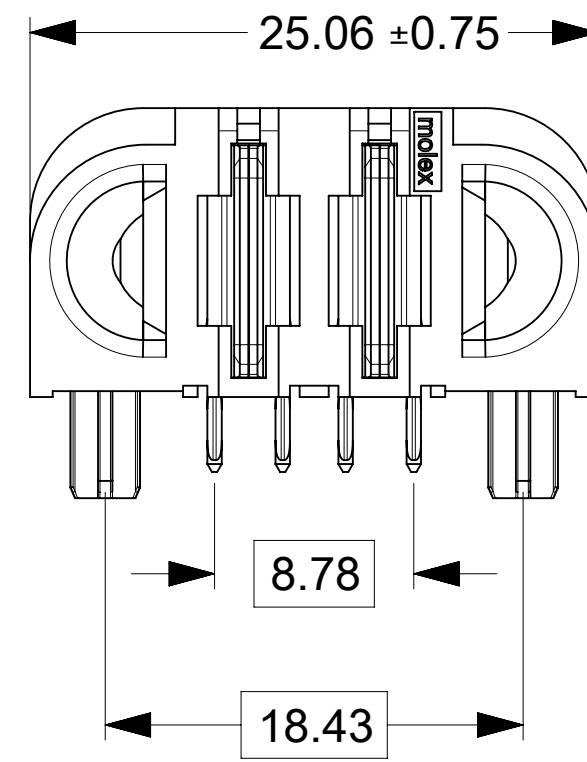

PART NUMBER	CONFIGURATION	QUANTITY PER CARTON (DU)
219562-0003	G+3P+G	120

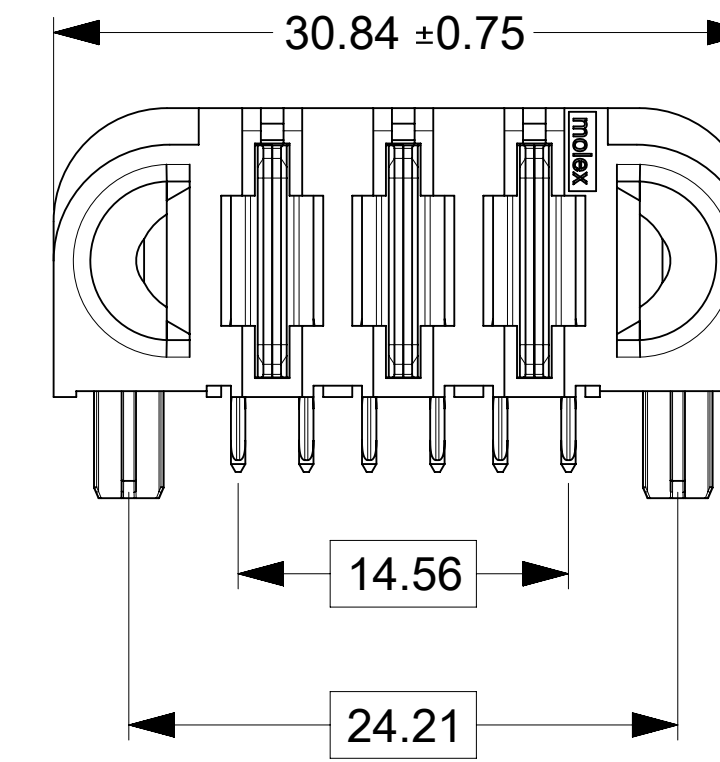

PART NUMBER	CONFIGURATION	QUANTITY PER CARTON (DU)
219562-0004	G+4P+G	105

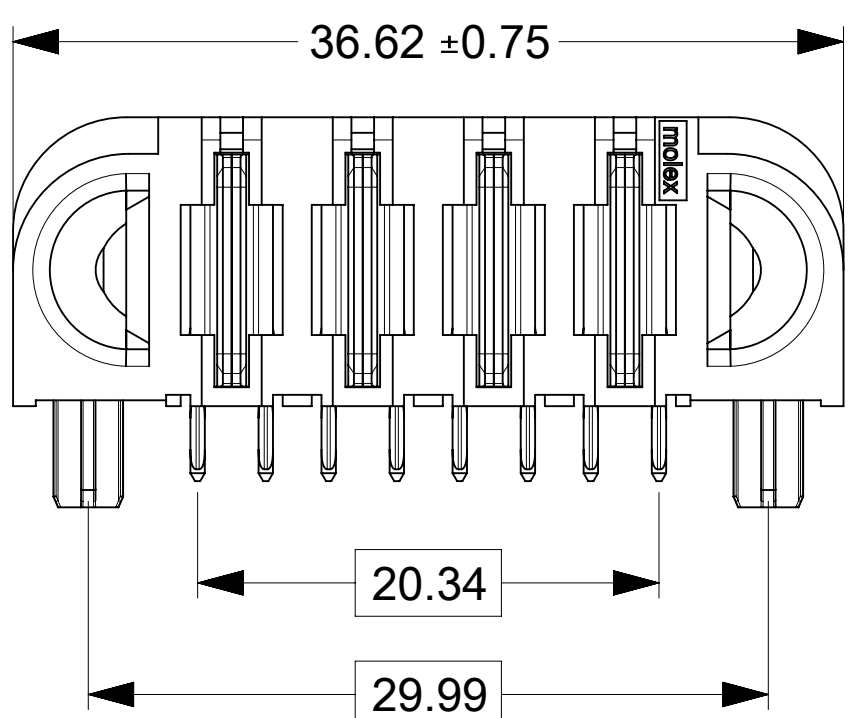

PART NUMBER	CONFIGURATION	QUANTITY PER CARTON (DU)
219562-0005	G+5P+G	90

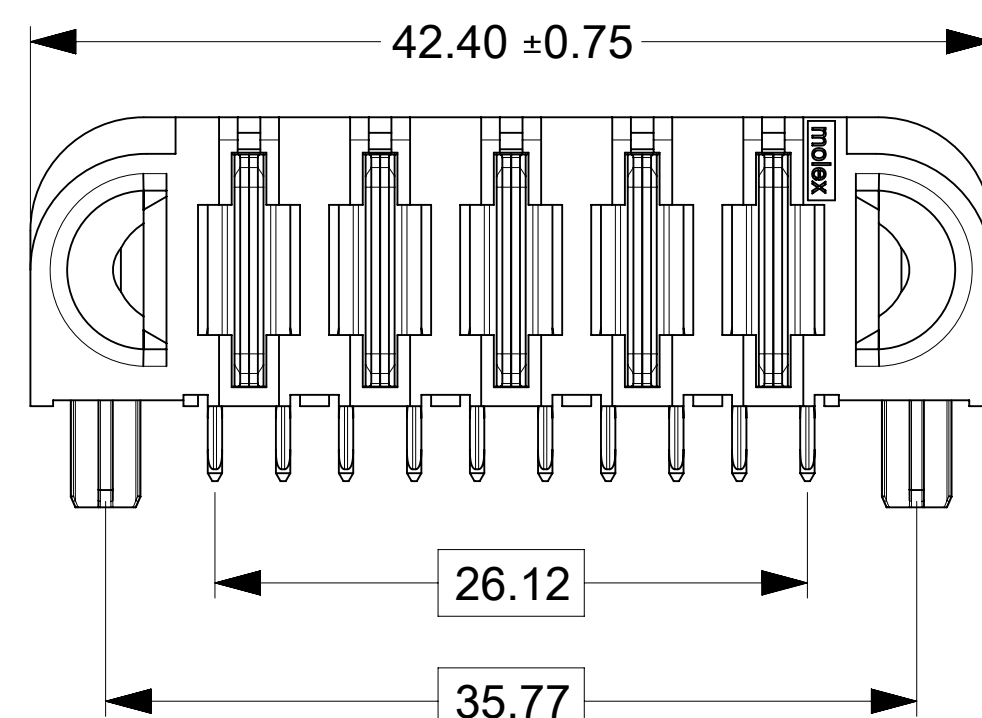

PART NUMBER	CONFIGURATION	QUANTITY PER CARTON (DU)
219562-0006	G+6P+G	75

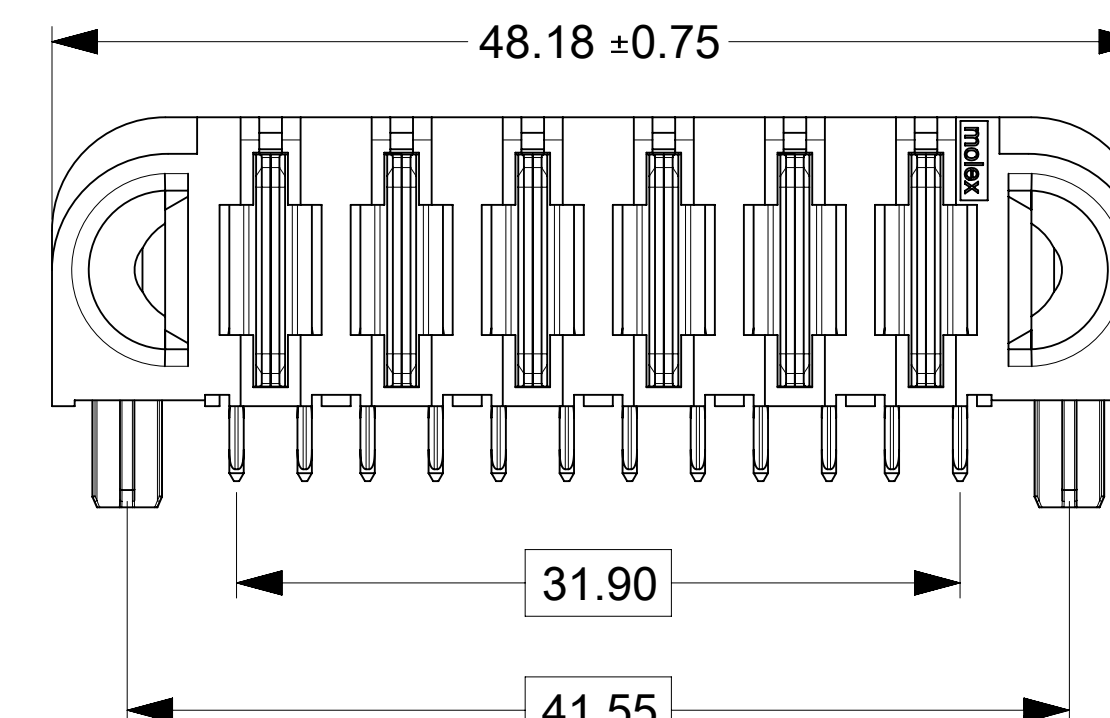

PART NUMBER	CONFIGURATION	QUANTITY PER CARTON (DU)
219562-0007	G+7P+G	60

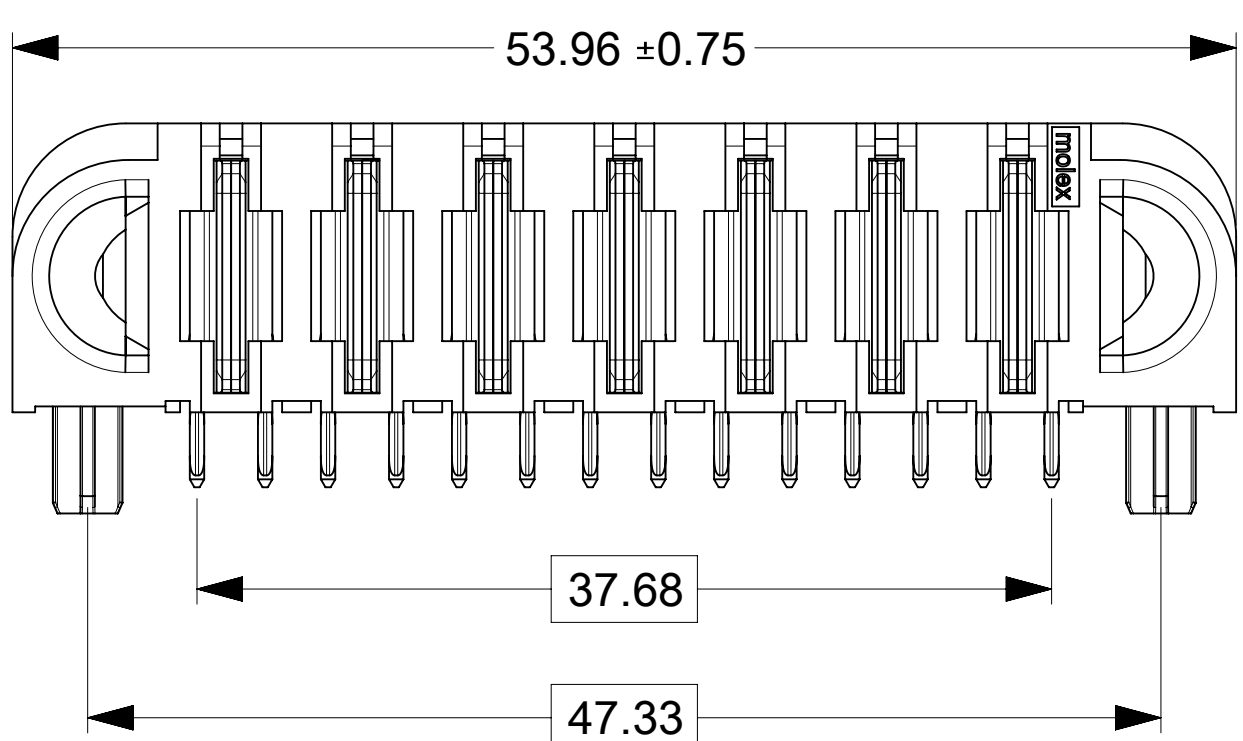

PART NUMBER	CONFIGURATION	QUANTITY PER CARTON (DU)
219562-0008	G+8P+G	60

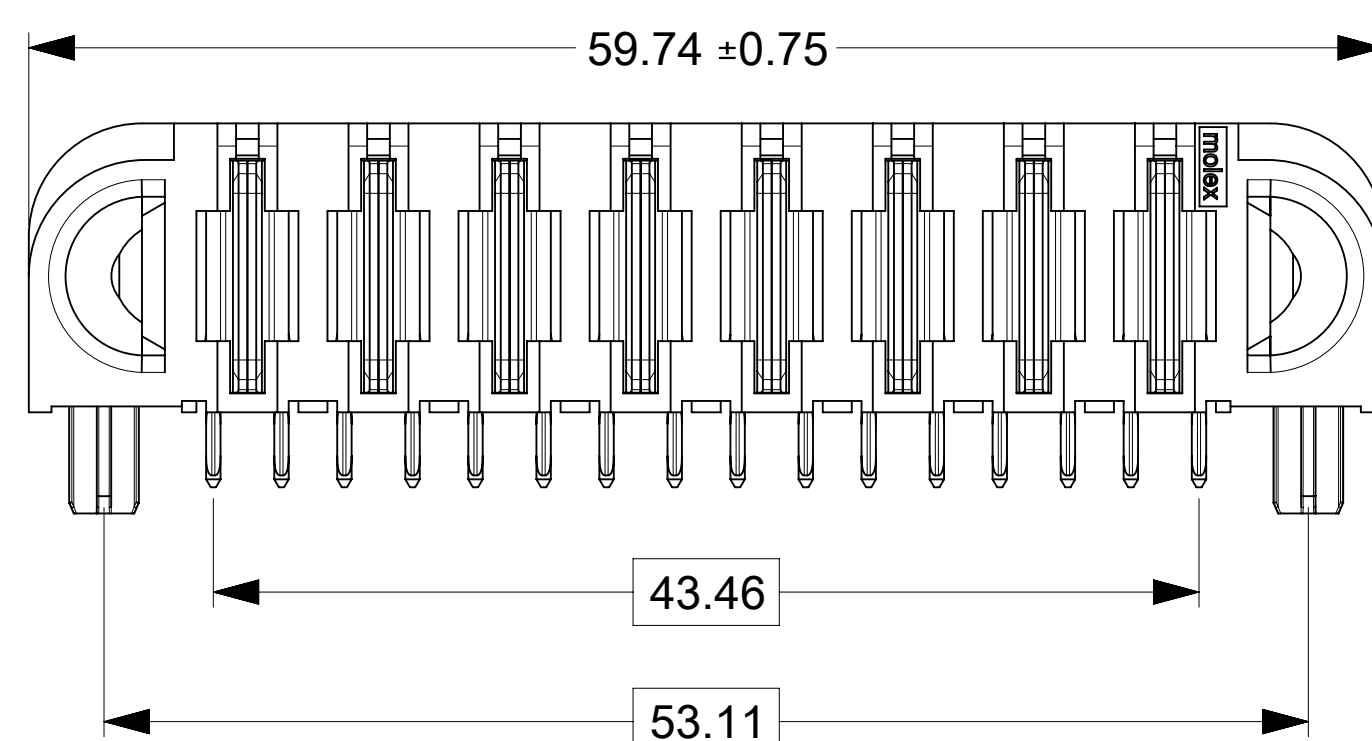

PART NUMBER	CONFIGURATION	QUANTITY PER CARTON (DU)
219562-0009	G+9P+G	45

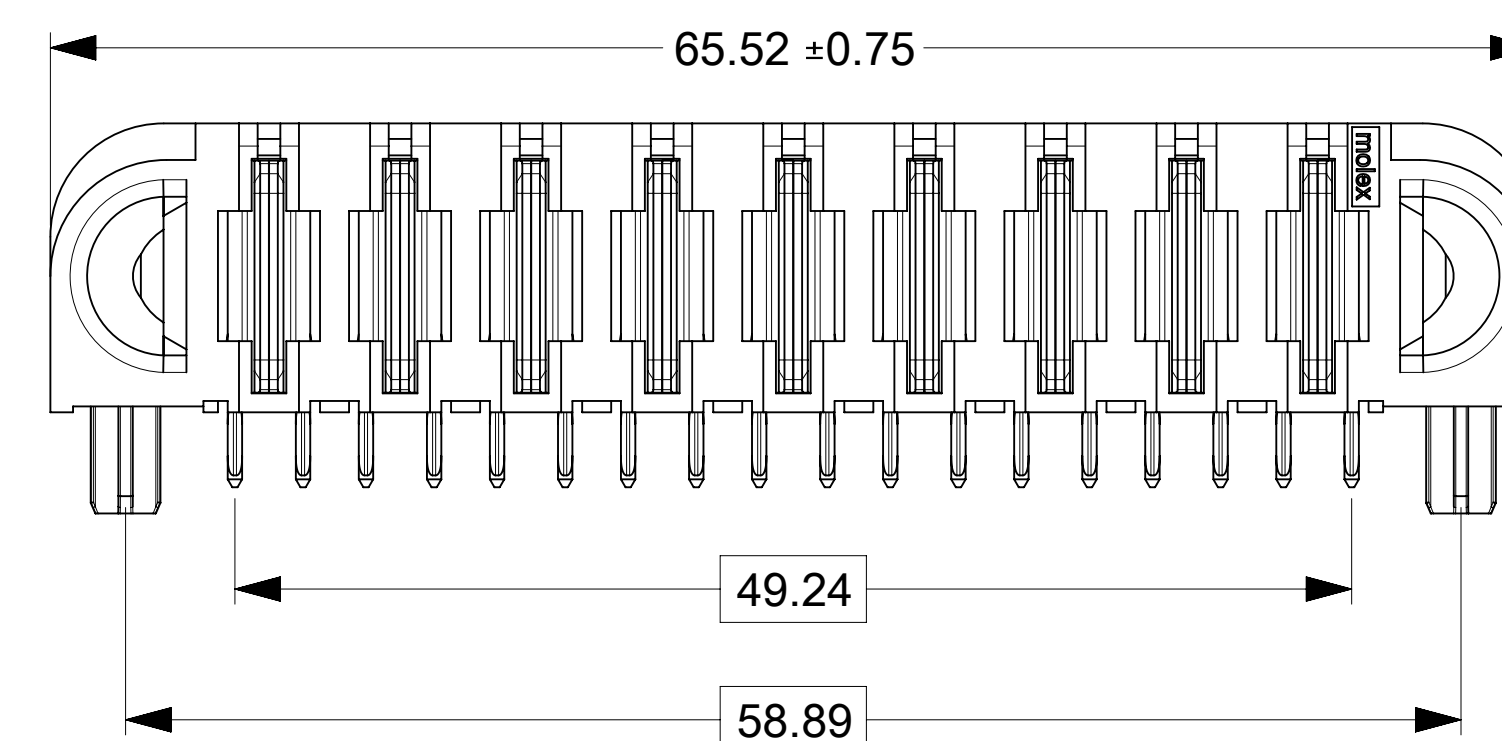

PART NUMBER	CONFIGURATION	QUANTITY PER CARTON (DU)
219562-0010	G+10P+G	45

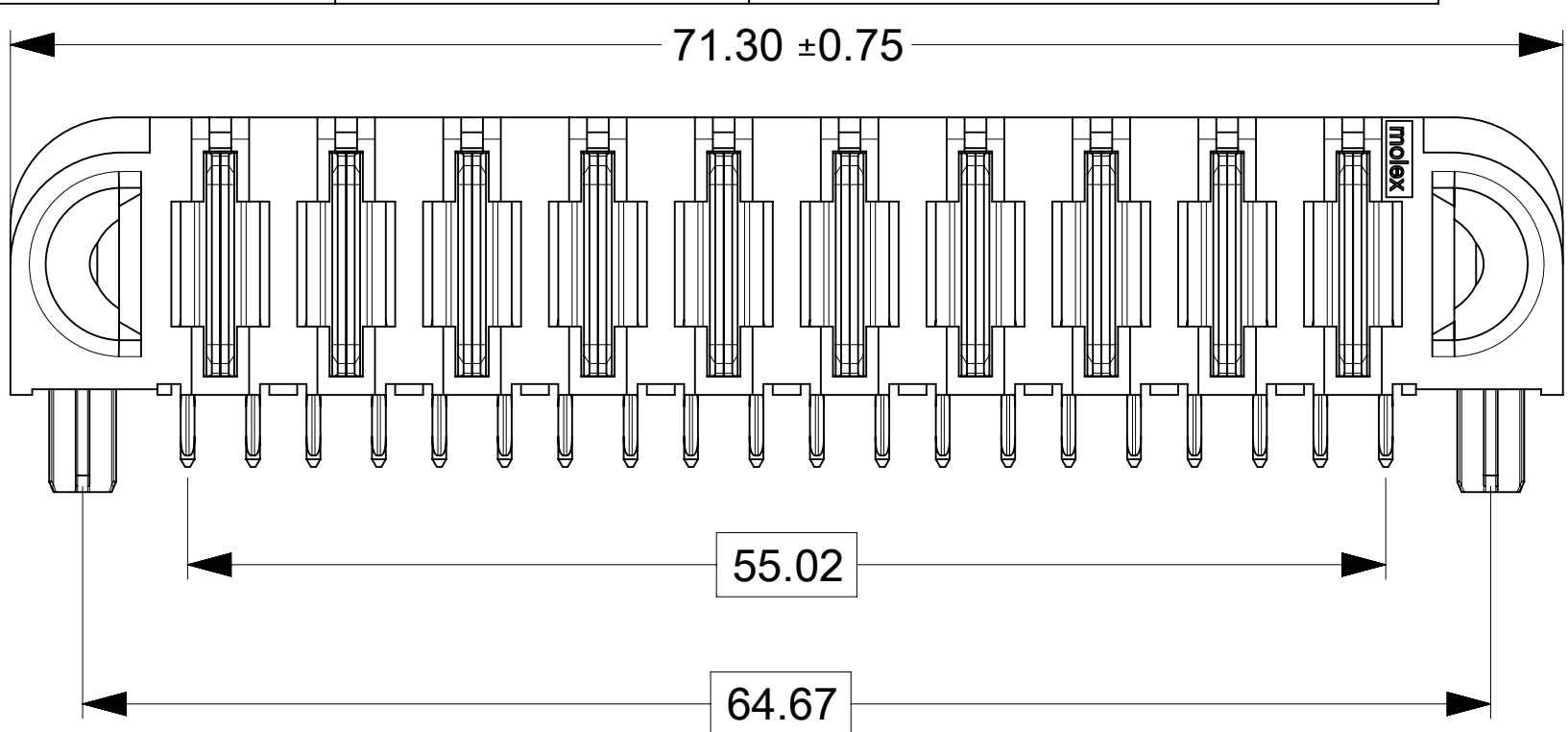

THIS DRAWING CONTAINS INFORMATION THAT IS PROPRIETARY TO MOLEX ELECTRONIC TECHNOLOGIES, LLC AND SHOULD NOT BE USED WITHOUT WRITTEN PERMISSION

DIMENSION UNITS	SCALE	CURRENT REV DESC:	
mm	3:1		
GENERAL TOLERANCES (UNLESS SPECIFIED)			
ANGULAR TOL	±	°	
4 PLACES	±		
3 PLACES	±		
2 PLACES	±	0.25	
1 PLACE	±	0.3	
0 PLACES	±		
DRAFT WHERE APPLICABLE MUST REMAIN WITHIN DIMENSIONS		THIRD ANGLE PROJECTION	DRAWING SERIES
			D-SIZE 219562

EC NO: 745288		2023/03/09	
DRWN: LZABJANOVSKI		2023/04/10	
CHK'D: JAYK1		2023/04/10	
APPR: JAYK1		2023/04/10	
INITIAL REVISION:			
DRWN: LZABJANOVSKI		2022/03/14	
APPR: BPISZCZOR		2022/08/04	

<b>molex</b>			
GUARDIAN HD RA PLUG POWER ONLY PF			
PRODUCT CUSTOMER DRAWING			
DOCUMENT NUMBER	DOC TYPE	DOC PART	REVISION
2195629000-SD	PSD	000	A1
MATERIAL NUMBER	CUSTOMER	SHEET NUMBER	
SEE CHART		2 OF 2	

DOCUMENT STATUS	P1	RELEASE DATE	2023/04/11	17:04:40
-----------------	----	--------------	------------	----------