

**PLUG MATED TO R/A RECEPTACLE  
MATED PROFILE**

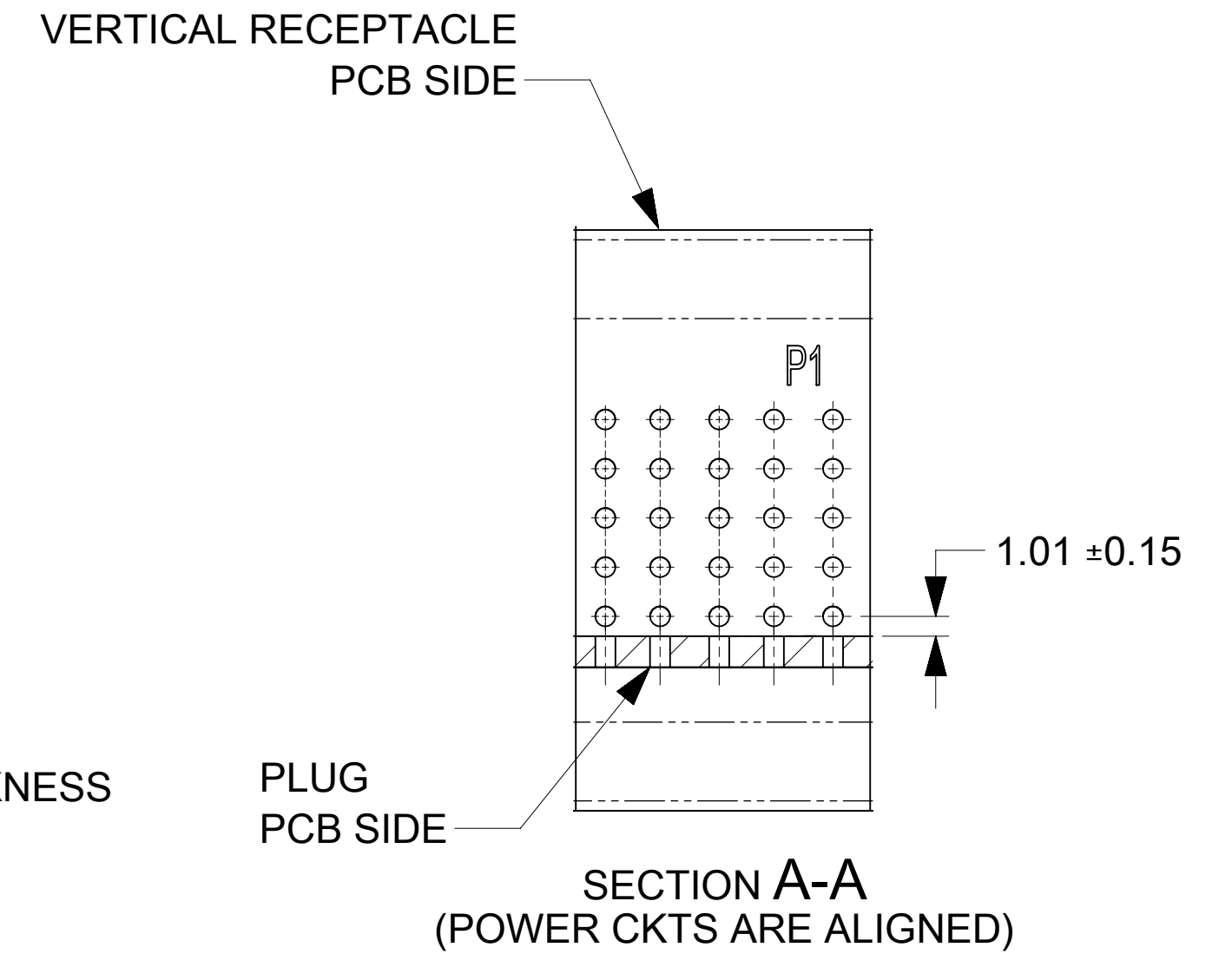

**PLUG MATED TO VERTICAL RECEPTACLE  
MATED PROFILE**

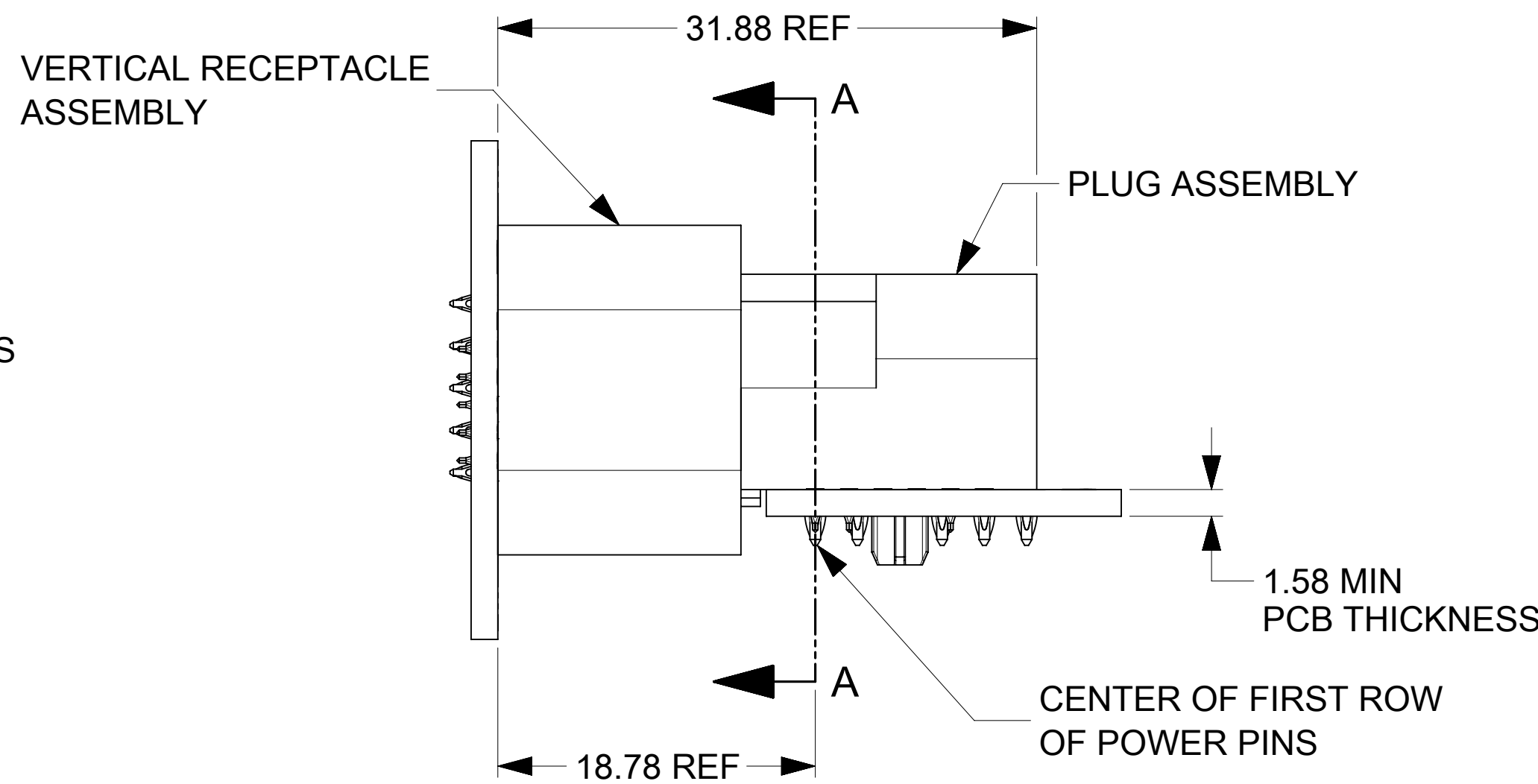
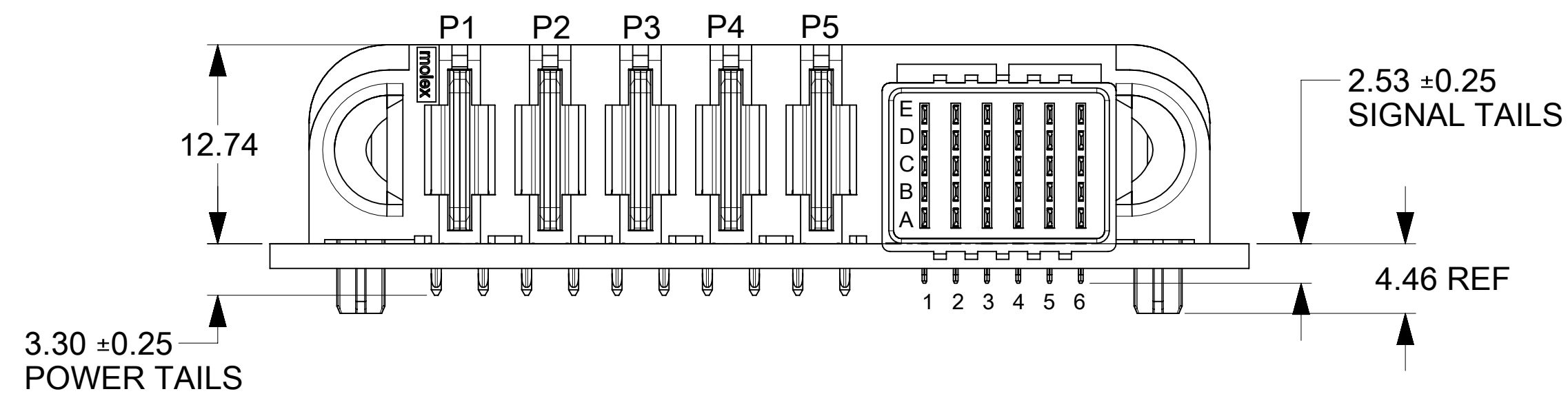
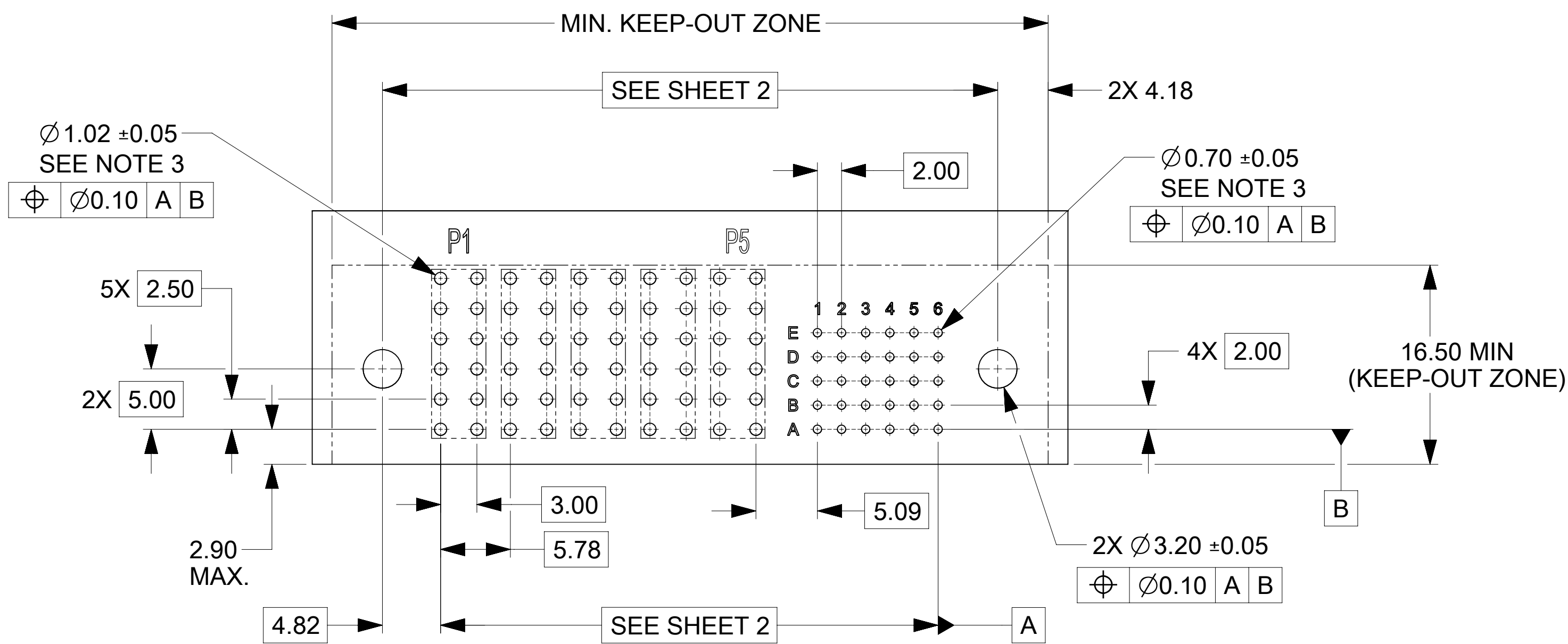

**NOTES:**

- MATERIAL:**  
 -HOUSINGS: LCP UL94, V-0, COLOR : BLACK  
 -TERMINALS: HIGH CONDUCTIVITY COPPER ALLOY  
 -PLATING: 1.27 μm (50 μin) NICKEL OVERALL WITH  
 2.54 μm (100 μin) SELECTIVE TIN ON TAILS AND  
 0.762 μm (30 μin) SELECTIVE GOLD ON CONTACT AREA
- PACKAGING:** ASSEMBLIES TO BE TRAY PACKED PER PACKAGING SPEC: 2141130010-PK.
- PLATED THRU HOLE SIZE,** REFER TO PRODUCT SPEC. FOR DETAILS.
- PRODUCT SPEC:** 2141130000-PS.
- PRODUCT TO MEET RoHS REQUIREMENTS.**
- PLUG ASSEMBLY MATES TO MOLEX RECEPTACLES** 219563XXXX-SD AND 219564XXXX-SD, SEE DRAWINGS FOR DETAILS.
- TAIL DESIGN:** COMPLIANT PIN.
- POWER TERMINALS AND SIGNALS ARE LUBRICATED.**
- APPLICATION SPECIFICATION:** 2141130000-AS (FOR COMPLIANT TAILS ONLY).

THIS DRAWING CONTAINS INFORMATION THAT IS PROPRIETARY TO MOLEX ELECTRONIC TECHNOLOGIES, LLC AND SHOULD NOT BE USED WITHOUT WRITTEN PERMISSION

DIMENSION UNITS	SCALE	CURRENT REV DESC:		<b>molex</b>			
mm	3:1						
GENERAL TOLERANCES (UNLESS SPECIFIED)		EC NO: 745288		GUARDIAN HD RA PLUG RIGHT SIGNAL WITH POWER PF			
ANGULAR TOL	± °	DRWN: LZABJANOVSKI	2023/03/09				
4 PLACES	±	CHK'D: JAYK1	2023/04/10	PRODUCT CUSTOMER DRAWING			
3 PLACES	±	APPR: JAYK1	2023/04/10				
2 PLACES	± 0.25	INITIAL REVISION:		DOCUMENT NUMBER			
1 PLACE	± 0.3	DRWN: LZABJANOVSKI	2022/03/14				2195629001-SD
0 PLACES	±	APPR: BPISZCZOR	2022/08/04	DOC TYPE	DOC PART	REVISION	
DRAFT WHERE APPLICABLE MUST REMAIN WITHIN DIMENSIONS		THIRD ANGLE PROJECTION	DRAWING	SERIES	MATERIAL NUMBER	CUSTOMER	SHEET NUMBER
			D-SIZE	219562	SEE CHART		1 OF 2

**RECOMMENDED PCB LAYOUT AND KEEP-OUT ZONE**

PART NUMBER	CONFIGURATION	QUANTITY PER CARTON (DU)
219562-0011	G+1P+15S+G	135

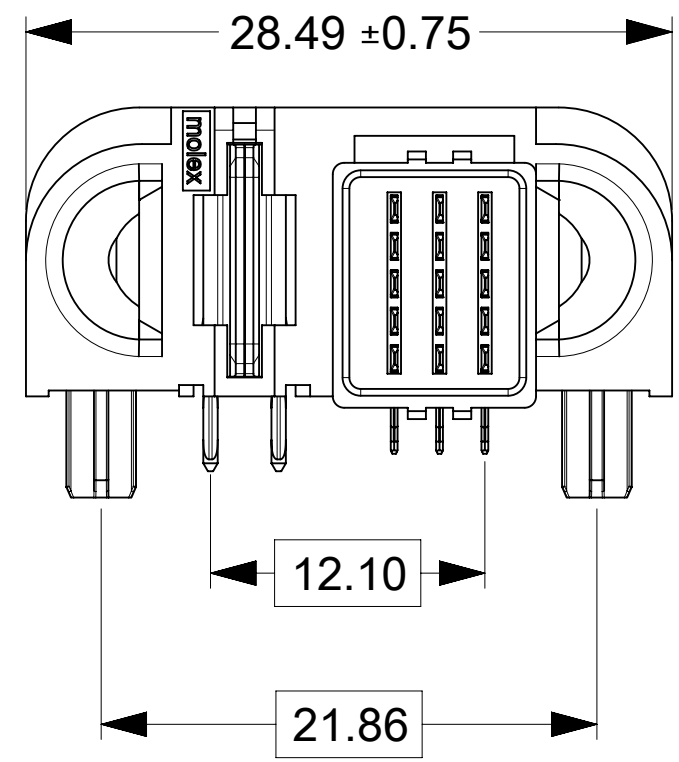

PART NUMBER	CONFIGURATION	QUANTITY PER CARTON (DU)
219562-0012	G+2P+15S+G	105

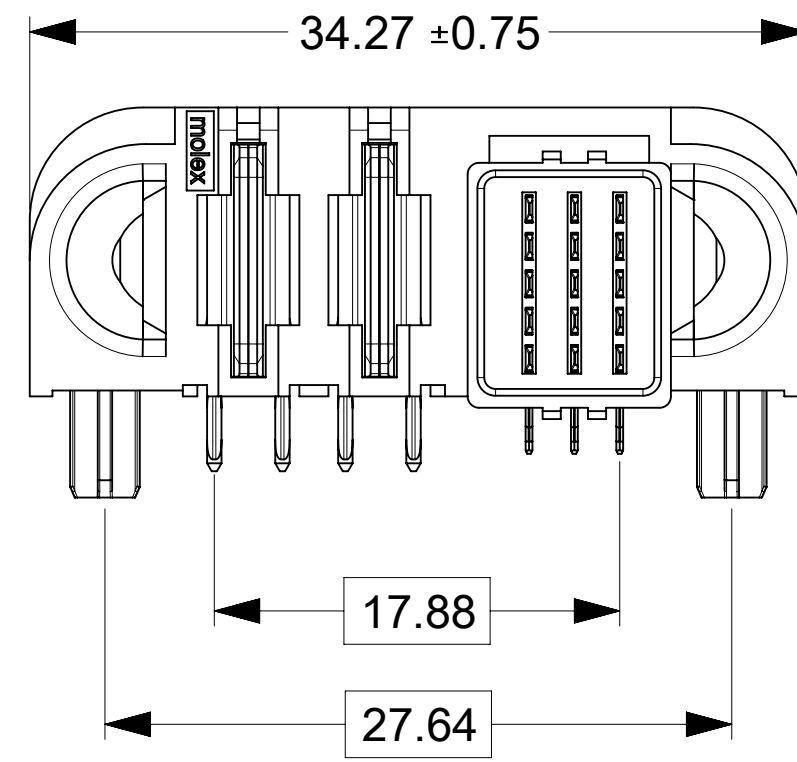

PART NUMBER	CONFIGURATION	QUANTITY PER CARTON (DU)
219562-0013	G+3P+15S+G	90

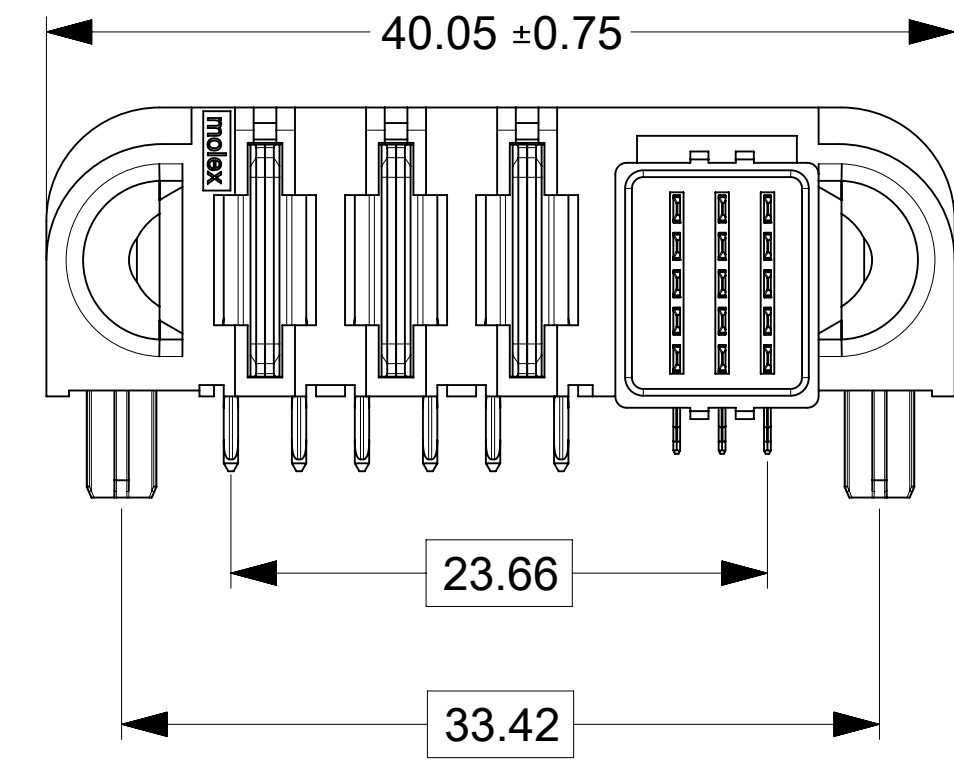

PART NUMBER	CONFIGURATION	QUANTITY PER CARTON (DU)
219562-0014	G+4P+15S+G	75

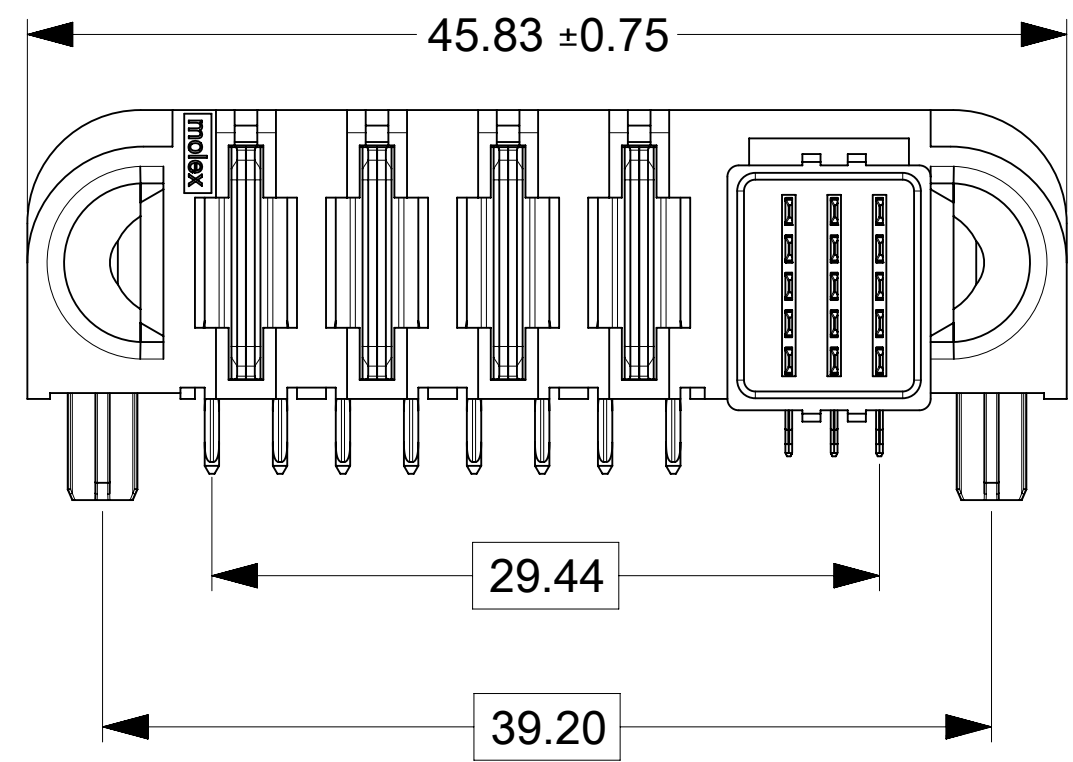

PART NUMBER	CONFIGURATION	QUANTITY PER CARTON (DU)
219562-0015	G+5P+15S+G	75

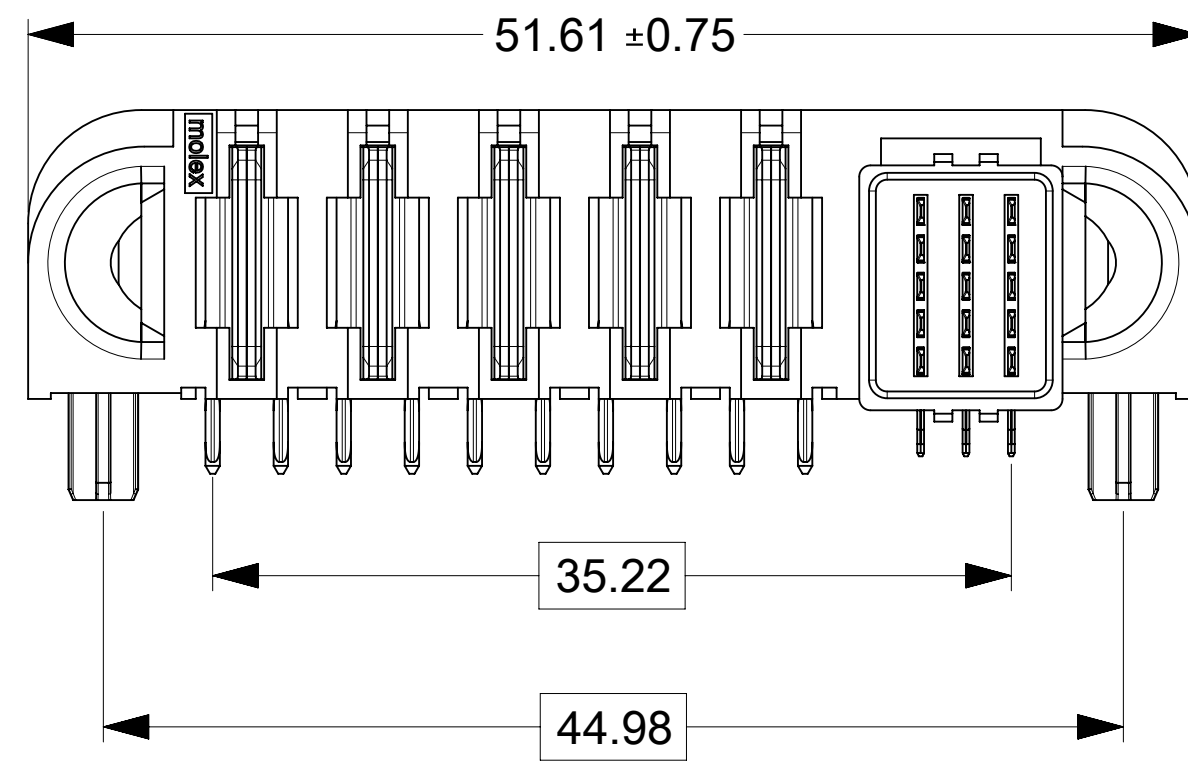

PART NUMBER	CONFIGURATION	QUANTITY PER CARTON (DU)
219562-0016	G+1P+30S+G	105

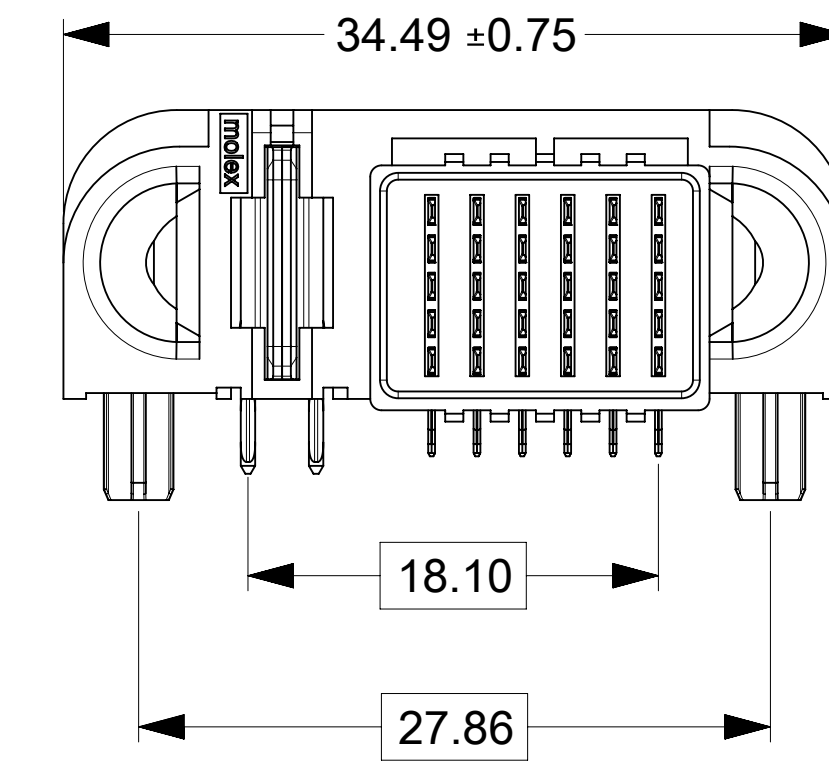

PART NUMBER	CONFIGURATION	QUANTITY PER CARTON (DU)
219562-0017	G+2P+30S+G	90

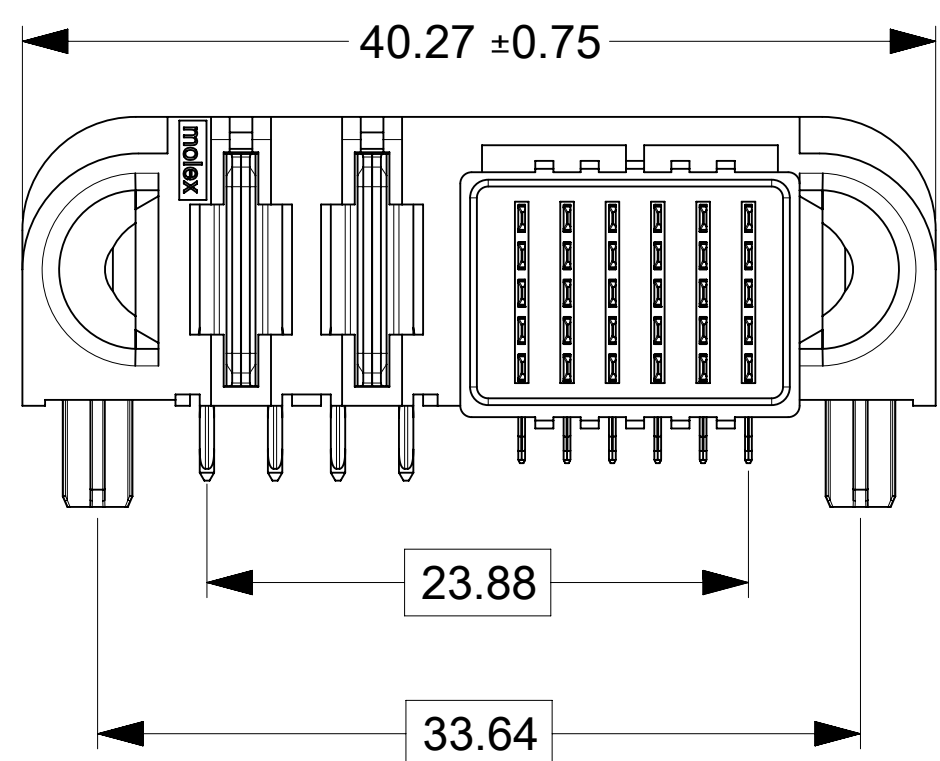

PART NUMBER	CONFIGURATION	QUANTITY PER CARTON (DU)
219562-0018	G+3P+30S+G	75

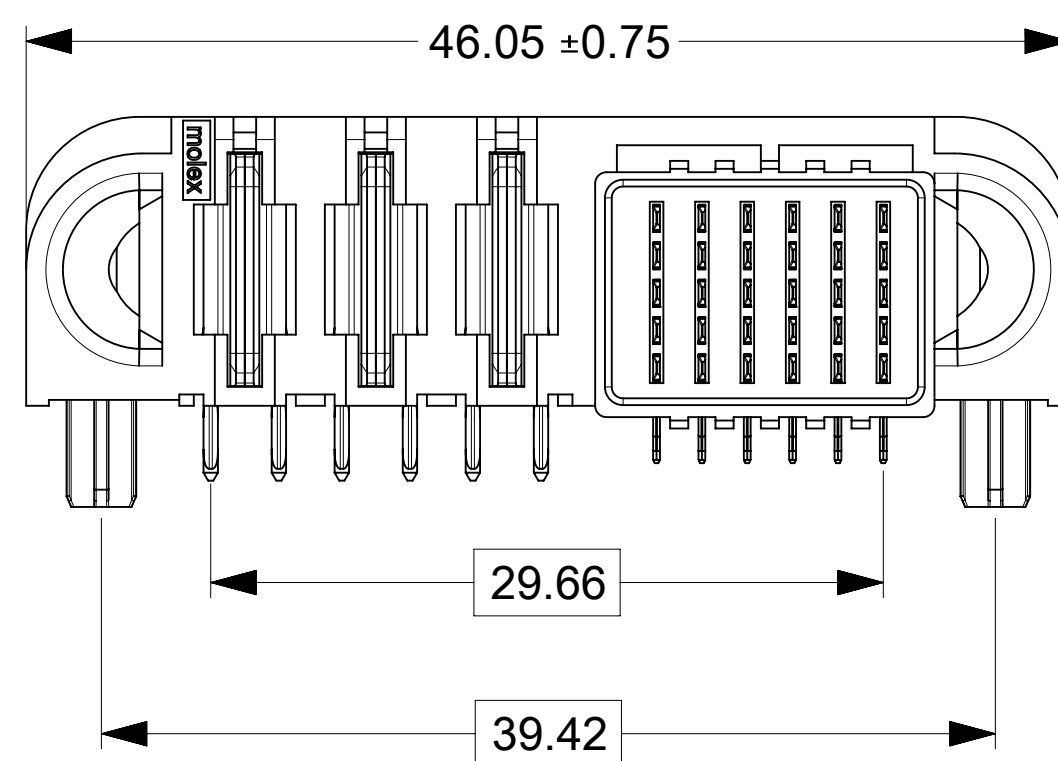

PART NUMBER	CONFIGURATION	QUANTITY PER CARTON (DU)
219562-0019	G+4P+30S+G	75

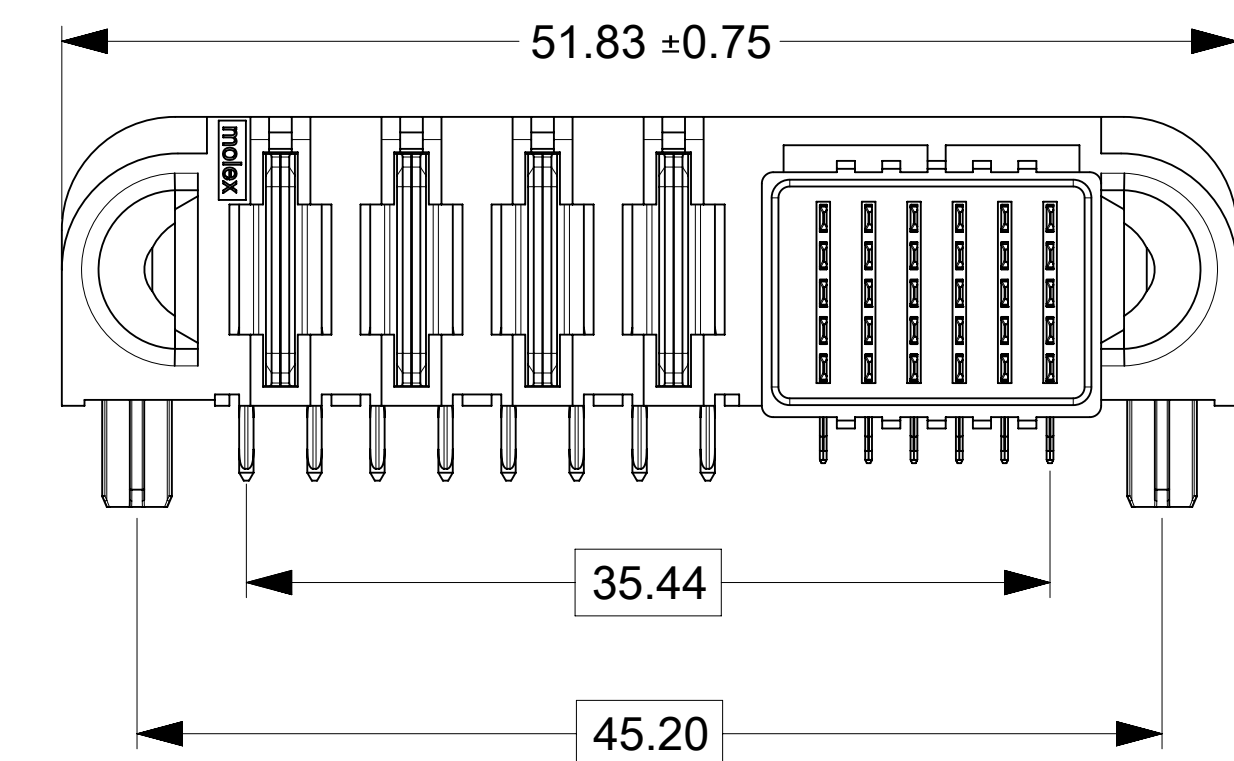

PART NUMBER	CONFIGURATION	QUANTITY PER CARTON (DU)
219562-0020	G+5P+30S+G	60

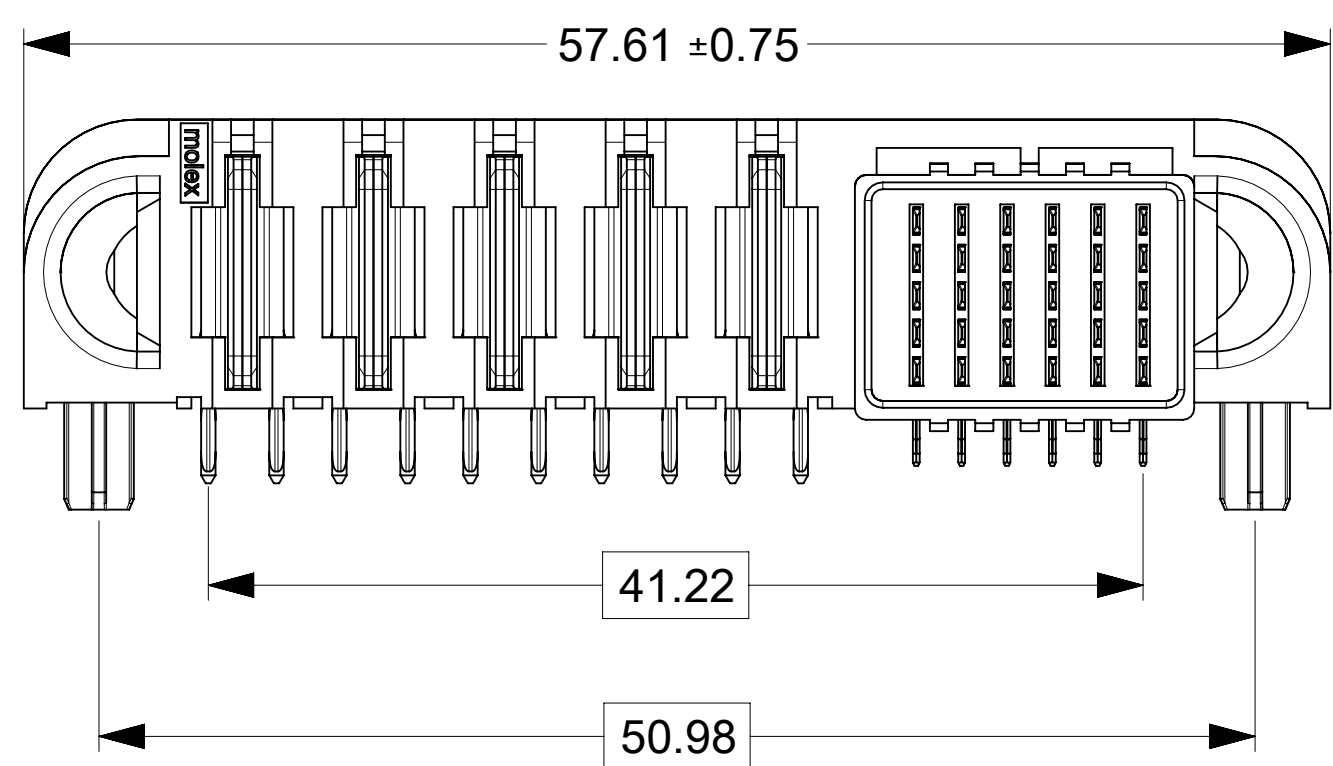

THIS DRAWING CONTAINS INFORMATION THAT IS PROPRIETARY TO MOLEX ELECTRONIC TECHNOLOGIES, LLC AND SHOULD NOT BE USED WITHOUT WRITTEN PERMISSION

DIMENSION UNITS	SCALE	CURRENT REV DESC:
mm	3:1	
GENERAL TOLERANCES (UNLESS SPECIFIED)		
ANGULAR TOL	±	°
4 PLACES	±	
3 PLACES	±	
2 PLACES	±	0.25
1 PLACE	±	0.3
0 PLACES	±	
DRAFT WHERE APPLICABLE MUST REMAIN WITHIN DIMENSIONS		
THIRD ANGLE PROJECTION	DRAWING	SERIES
	D-SIZE	219562
EC NO: 745288		DRWN: LZABJANOVSKI 2023/03/09
CHK'D: JAYK1 2023/04/10		APPR: JAYK1 2023/04/10
INITIAL REVISION:		
DRWN: LZABJANOVSKI 2022/03/14		APPR: BPISZCZOR 2022/08/04
DOCUMENT NUMBER	DOC TYPE	DOC PART
2195629001-SD	PSD	000
MATERIAL NUMBER	CUSTOMER	REVISION
SEE CHART		A1
SHEET NUMBER		
2 OF 2		

DOCUMENT STATUS	P1	RELEASE DATE	2023/04/11	17:04:40
-----------------	----	--------------	------------	----------

**molex**

GUARDIAN HD RA PLUG RIGHT SIGNAL WITH POWER PF

PRODUCT CUSTOMER DRAWING