

# AZ DISPLAYS

---

## SPECIFICATIONS FOR LIQUID CRYSTAL DISPLAY

CUSTOMER APPROVAL			
※ PART NO. : <u>ATM0231D2(AZ DISPLAYS) VER1.3</u>			
APPROVAL		COMPANY CHOP	
CUSTOMER COMMENTS			

AZ DISPLAYS ENGINEERING APPROVAL		
DESIGNED BY	CHECKED BY	APPROVED BY
XW	GZC	GZH

**REVISION RECORD**

REVISION	REVISION DATE	PAGE	CONTENTS
<b>PRELIMINARY</b>	<b>2020-05-25</b>	<b>--</b>	<b>FIRST ISSUE</b>
<b>V1.1</b>	<b>2020-05-27</b>	<b>3/15</b>	<b>REPLACE THE BACKLIGHT</b>
<b>V1.2</b>	<b>2020-06-05</b>	<b>3/8</b>	<b>UPDATE THE BRIGHTNESS</b>
<b>V1.3</b>	<b>2020-12-25</b>	<b>3/16</b>	<b>UPDATE PACKAGING AND WEIGHT INFORMATION</b>

※ **CONTENTS**

1. GENERAL SPECIFICATIONS
2. PIN ASSIGNMENT
3. OPERATING SPECIFICATIONS
4. OPTICAL SPECIFICATIONS
5. RELIABILITY TEST
6. PRECAUTION FOR USING LCM
7. MECHANICAL DRAWING
8. PACKAGE DRAWING
9. INSPECTION SPECIFICATION

## 1. GENERAL SPECIFICATIONS

Item	Specification	Remark
1. LCD size	2.31 inch(Diagonal)	
2. Driver element	a-Si TFT active matrix	
3. Resolution	320x(RGB)x240	
4. Display mode	Normally White	
5. Dot Pitch (W*H)	0.0487mm(W) x 0.1461mm(H)	
6. Pixel pitch(W*H)	0.1461mm(W) x 0.1461mm(H)	
7. Active Area(W*H)	46.752mm(W) x 35.064mm(H)	
8. Module size (W*H*D)	51mm x 45.8mm x 2.5mm	Note 1
9. Surface treatment	Anti glare	
10. Color arrangement	RGB-stripe	
11. Color	262K	
12. Viewing angle	U/L/D/R/ : 55/65/65/65	
13. Interface	18bit RGB	
14. LCD controller	ILI9342C	
15. LCM Brightness	350 cd/m2 Typ.	
16. Backlight driving condition	20mA @10.8V~13.2V	
17. Cover Lens	N.A	
18. Touch controller	N.A.	
19. Operation Temperature	-20~70 °C	
20. Weight	9.7g	
21. RoHS	RoHS compliant	

**Note 1:** Please refer to mechanical drawing.

## 2. PIN ASSIGNMENT

### TFT LCD Panel Driving Section

FPC Connector is used for the module electronics interface. The recommended model is "FH26-39S-0.3SHW" manufactured by Hirose or other compatible connectors.

Pin No.	Symbol	Function	Level	Note
1	RESET	Global reset pin	I	
2	CS	Chip select	I	
3	SCL	SPI clock	I	
4	SDA	SPI data	I	
5	GND	Ground	P	
6	DCLK	Dot clock signal for RGB interface operation.	I	
7	GND	Ground	P	
8	ENABLE	Data enable signal for RGB interface operation.	I	
9~14	DB0~DB5	Data bus	I	
15	GND	Ground	P	
16~27	DB6~DB17	Data bus	I	
28	GND	Ground	P	
29	HSYNC	Horizontal sync	I	
30	VSYNC	Vertical sync	I	
31	GND	Ground	P	
32	VCI	High voltage power supply (2.6V ~ 3.3 V)	P	
33	IOVCC	Low voltage power supply (1.65V ~ 3.3 V)	P	
34	NC	No connection	--	
35	LEDK	Backlight cathode	P	
36	NC	No connection	--	
37	LEDA	Backlight anode	P	
38	NC	No connection	--	
39	GND	Ground	P	

**I: input, O: output, P: Power**

### 3. Operating Specification

#### 3.1 ABSOLUTE MAXIMUM RATINGS

Item	Symbol	Values		Unit	Remark
		Min.	Max.		
Power Voltage	VCC/IOVCC	-0.3	4.6	V	
Operation Temperature	T <sub>OP</sub>	-20	70	°C	
Storage Temperature	T <sub>ST</sub>	-30	80	°C	
LED Reverse Voltage	V <sub>R</sub>	-	1.2	V	Each LED Note 2
LED Forward Current	I <sub>F</sub>		25	mA	Each LED

**Note 1:** The absolute maximum rating values of this product are not allowed to be exceeded at any times. Should a module be used with any of the absolute maximum ratings exceeded, the characteristics of the module may not be recovered, or in an extreme case, the module may be permanently destroyed.

**Note 2:** V<sub>R</sub> Conditions: Zener Diode 20mA

#### 3.2 Typical Operation Conditions

Item	Symbol	Values			Unit	Remark
		Min.	Typ.	Max.		
Operating voltage	VCC	2.4	2.8	3.3	V	
Input Logic High Voltage	V <sub>IH</sub>	0.7VCC	--	VCC	V	
Input Logic Low Voltage	V <sub>IL</sub>	V <sub>ss</sub>	--	0.3VCC	V	
Operating current	I <sub>Lcm</sub>	--	29.40	--	mA	VCC=2.8V I <sub>L</sub> =20mA

3.3 Backlight driving conditions

Item	Symbol	Values			Unit	Remark
		Min.	Typ.	Max.		
Voltage for LED Backlight	$V_L$	10.8	12.4	13.2	V	Note 1
Current for LED Backlight	$I_L$	--	20	--	mA	
LED life time	--	30000	--	--	Hr	Note 2

**Note 1:** The LED Supply Voltage is defined by the number of LED at  $T_a=25^{\circ}\text{C}$  and  $I_L=20\text{mA}$ .

**Note 2:** The "LED life time" is defined as the module brightness decrease to 50% original brightness at  $T_a=25^{\circ}\text{C}$  and  $I_L=20\text{mA}$ .

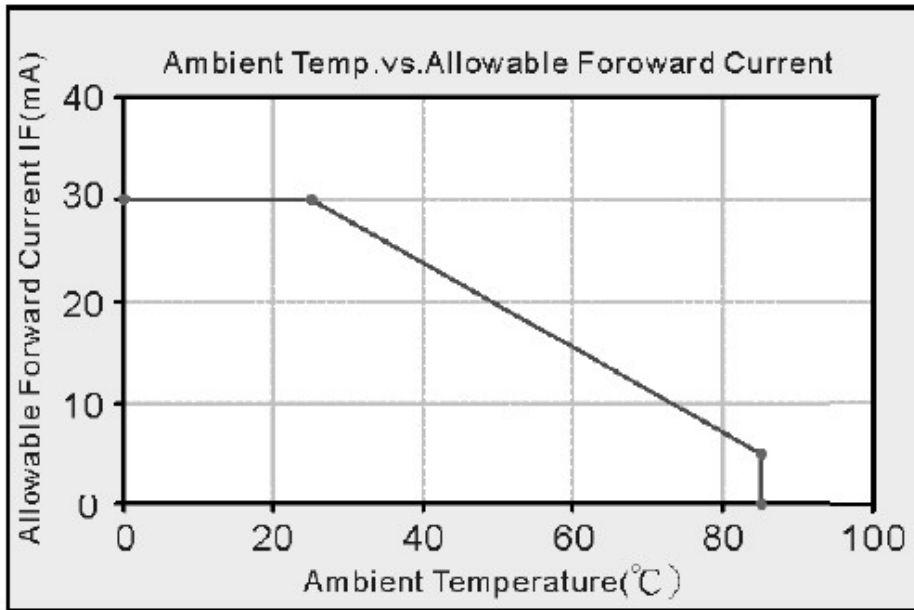

### 3.4 Timing Characteristics

Please refer to ILI9342C IC specification for detailed information.



4.0 OPTICAL SPECIFICATIONS

Item	Symbol	Condition	Values			Unit	Remark
			Min.	Typ.	Max.		
Viewing Angle (CR ≥ 10)	$\theta_L$	$\Phi=180^\circ$ (9 O'CLOCK)	--	65	--	degree	Note 1
	$\theta_R$	$\Phi=0^\circ$ (3 O'CLOCK)	--	65	--		
	$\theta_T$	$\Phi=90^\circ$ (12 O'CLOCK)	--	55	--		
	$\theta_B$	$\Phi=270^\circ$ (6 O'CLOCK)	--	65	--		
Response Time	$T_{ON} + T_{OFF}$	Normal $\Theta = \Phi = 0^\circ$	--	30	40	msec	Note 3
Contrast Ratio	CR		400	500	--	--	Note 4
Color Chromaticity	$W_X$		0.283	0.303	0.323	--	Note 2
	$W_Y$		0.304	0.324	0.344	--	Note 5 Note 6
Luminance	L		300	350	--	cd/m <sup>2</sup>	Note 6
Luminance Uniformity	YU		80	--	--	%	Note 7

Test Conditions:

1. IL=20mA (Backlight current), the ambient temperature is 25°C.
2. The test systems refer to Note 2.

Note 1: Definition of viewing angle range

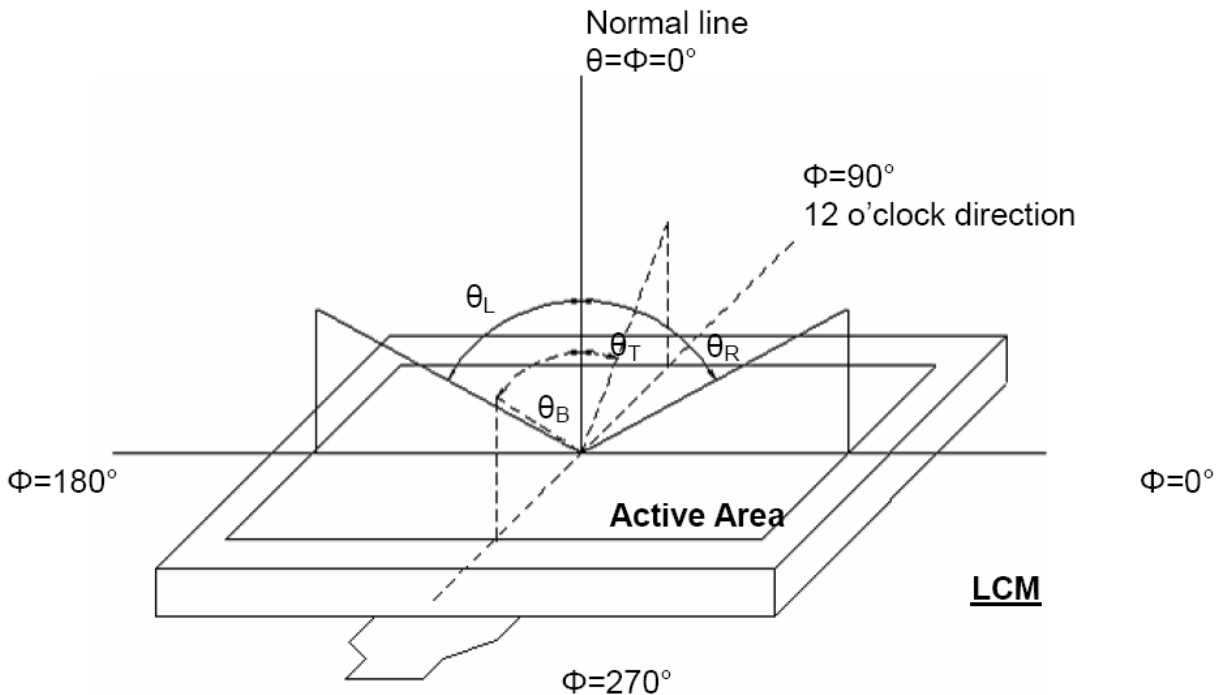

Figure 4.1 Definition of viewing angle.

**Note 2:** Definition of optical measurement system.

The optical characteristics should be measured in dark room. After 30 minutes operation, the optical properties are measured at the center point of the LCD screen. (Response time is measured by Photo detector TOPCON)

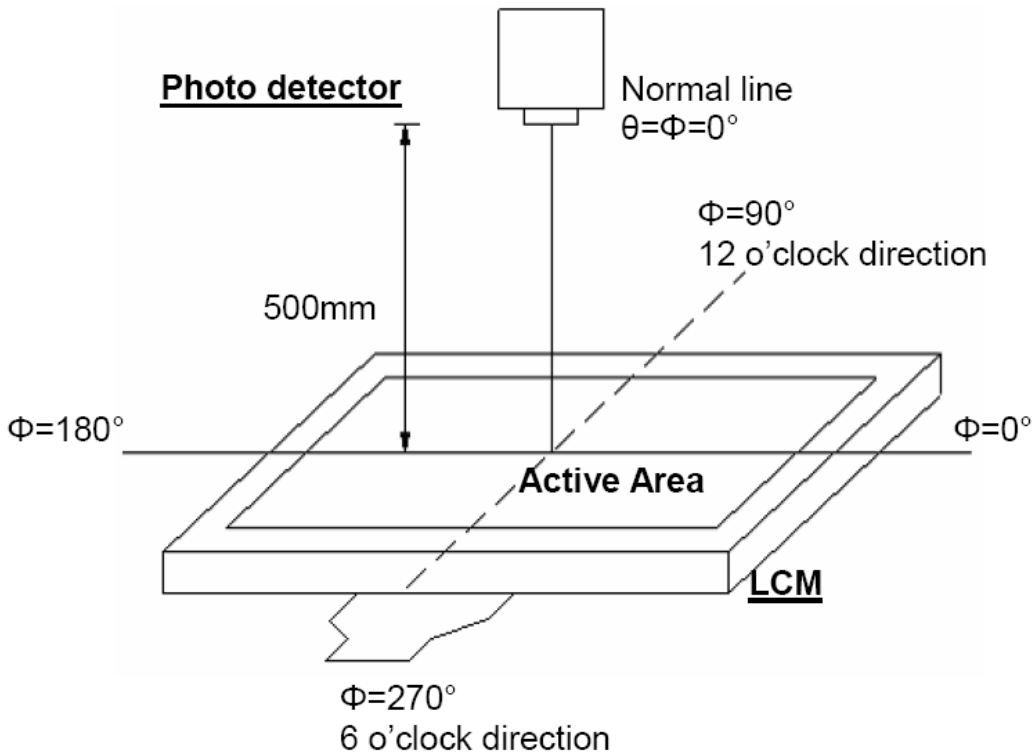

Figure 4.2 Optical measurement system setup

**Note 3:** Definition of Response time

The response time is defined as the LCD optical switching time interval between "White" state and "Black" state. Rise time ( $T_{ON}$ ) is the time between photo detector output intensity changed from 90% to 10%. And fall time ( $T_{OFF}$ ) is the time between photo detector output intensity changed from 10% to 90%.

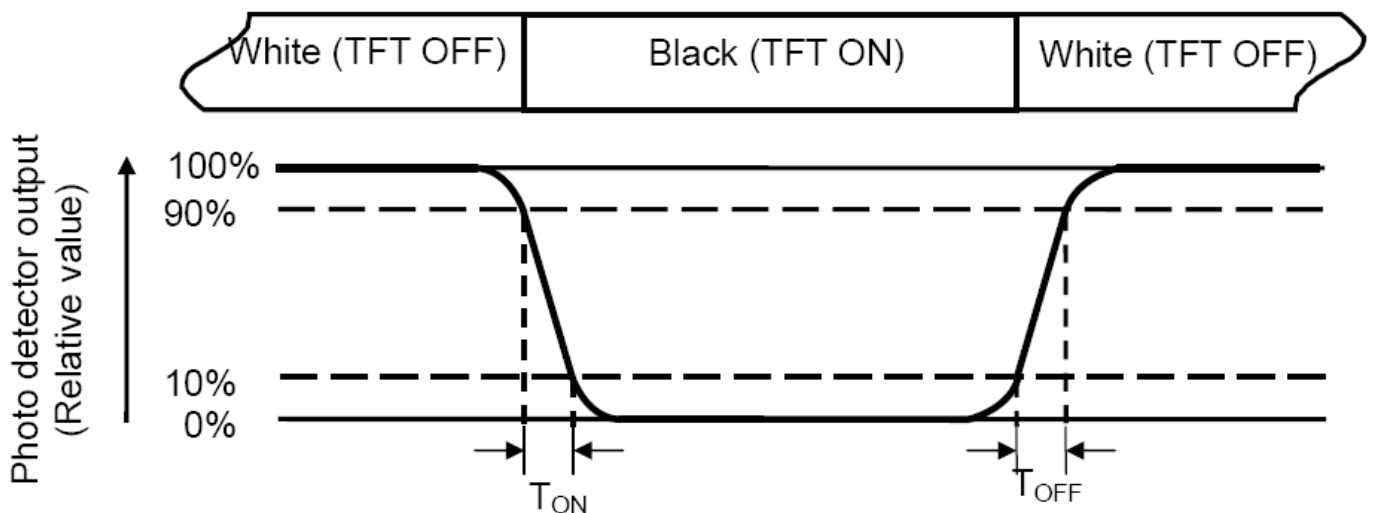

Figure 4.3 Definition of response.

**Note 4:** Definition of contrast ratio

$$\text{Contrast ratio(CR)} = \frac{\text{Luminance measured when LCD on the "white" state}}{\text{Luminance measured when LCD on the "black" state}}$$

**Note 5:** Definition of color chromaticity (CIE1931)

Color coordinates measured at center point of LCD.

**Note 6:** All input terminals LCD panel must be ground while measuring the center area of the panel. The LED driving condition is  $I_L=40\text{mA}$ .

**Note 7:** Definition of Luminance Uniformity

Active area is divided into 5 measuring areas (Refer to Fig. 4-4 ).Every measuring point is placed at the center of each measuring area.

$$\text{Luminance Uniformity (Yu)} = \frac{B_{min}}{B_{max}}$$

L-----Active area length      W----- Active area width

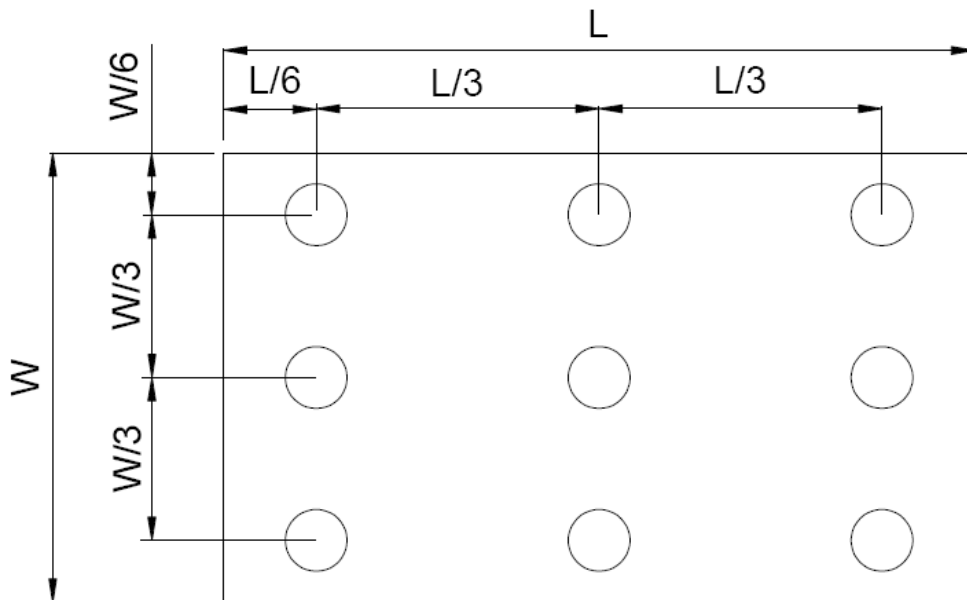

Figure 4.4 Definition of measuring points.

Bmax: The measured maximum luminance of all measurement position.

Bmin: The measured minimum luminance of all measurement position.

## 5. RELIABILITY TEST

NO..	Test Item	Description	Test Condition	Remark
1	High temperature storage	Endurance test applying the high storage temperature for a long time	80°C,96 H	Note 1 Note 4
2	Low temperature storage	Endurance test applying the low storage temperature for a long time	-30°C,96H	Note 1 Note 4
3	High temperature operation	Endurance test applying the electric stress under high temperature for a long time	75°C,72H	Note 2 Note 4
4	Low temperature operation	Endurance test applying the electric stress under low temperature for a long time	-30°C,72H	Note 1 Note 4
5	High temperature /humidity storage	Endurance test applying the high temperature and high humidity storage for a long time	85°C, 85% R.H 72H	Note 4
6	Temperature Cycle	Endurance test applying the low and high temperature cycle: -30°C/30min → 25°C/5min → 85°C/30min → 25°C/5min one cycle	-30°C~25°C~85°C~25°C, 50 cycles	Note 4
7	Thermal Shock	Endurance test applying the low and high temperature shock : -30°C/30min → 85°C/30min one cycle	-30°C~85°C, 100 cycles	Note 4
8	Vibration test	Endurance test applying the vibration during transportation and using	10Hz~500Hz ,30m/s2, XYZ each direction 2H	Note 3
9	Static electricity test	Endurance test applying static electric stress to terminal	Display surface discharge: Contact: ±2KV~8KV Air: ±2KV~15KV No display surface discharge: Contact: ±2KV~4KV Air: ±2KV~8KV	Note 3
10	Life test	Endurance test applying the the electric stress for a long time	25°C, 500H	Note 5
11	Endurance test	Endurance test applying electric stress under intermittent on-off cycle test	25°C, 1min ON~1min OFF , 10000 cycles	Note 3
12	FPC tension test	Endurance test applying during production operation	Angle between FPC and LCD: 90 ° , tensile speed: 50mm / min >700gf/cm	Note 3

ATM0231D2 (AZ DISPLAYS) TFT MODULE VER1.3

13	FPC bending strength test	Endurance test applying during production operation	<p>1. One side of FPC and LCD: bend the FPC 180 degrees to the direction of backlight module for 50 times continuously.</p> <p>2. One side of FPC and reinforcing plate: bend the FPC to 90 degrees, once for up and down bending, 25 times for continuous bending.</p>	Note 3
14	Bond strength test	Adhesion strength test of LCM and lens	Bond strength > 3N / cm	Note 3

**Note 1:** Ta is the ambient temperature of samples.

**Note 2:** Ts is the temperature of panel's surface.

**Note 3:** In the standard condition, there shall be no practical problem that may affect the display function. After the reliability test, the product only guarantees operation, but don't guarantee all of the cosmetic specification.

**Note 4:** Before cosmetic and function test, the product must have enough recovery time, at least 2 hours at room temperature.

**Note 5:** Luminance loss not more than 15%, color Chromaticity change not more than 0.02.

## 6. PRECAUTION FOR USING LCM

1. When design the product with this LCD Module, make sure the viewing angle matches to its purpose of usage.
2. As LCD panel is made of glass substrate, Dropping the LCD module or banging it against hard objects may cause cracking or fragmentation. Especially at corners and edges.
3. Although the polarizer of this LCD Module has the anti-glare coating, always be careful not to scratch its surface. Use of a plastic cover is recommended to protect the surface of polarizer.
4. If the LCD module is stored at below specified temperature, the LC material may freeze and be deteriorated. If it is stored at above specified temperature, the molecular orientation of the LC material may change to Liquid state and it may not revert to its original state. Excessive temperature and humidity could cause polarizer peel off or bubble. Therefore, the LCD module should always be stored within specified temperature range.
5. Saliva or water droplets must be wiped off immediately as those may leave stains or cause color changes if remained for a long time. Water vapor will cause corrosion of ITO electrodes.
6. If the surface of LCD panel needs to be cleaned, wipe it swiftly with cotton or other soft cloth. If it is not still clean enough, blow a breath on the surface and wipe again.
7. The module should be driven according to the specified ratings to avoid malfunction and permanent damage. Applying DC voltage cause a rapid deterioration of LC material. Make sure to apply alternating waveform by continuous application of the M signal. Especially the power ON/OFF sequence should be kept to avoid latch-up of driver LSIs and DC charge up to LCD panel.
8. Mechanical Considerations
  - a) LCM are assembled and adjusted with a high degree of precision. Avoid excessive shocks and do not make any alterations or modifications. The following should be noted.
  - b) Do not tamper in any way with the tabs on the metal frame.
  - c) Do not modify the PCB by drilling extra holes, changing its outline, moving its components or modifying its pattern.
  - d) Do not touch the elastomer connector; especially insert a backlight panel (for example, EL).
  - e) When mounting a LCM makes sure that the PCB is not under any stress such as bending or twisting. Elastomer contacts are very delicate and missing pixels could result from slight dislocation of any of the elements.
  - f) Avoid pressing on the metal bezel, otherwise the elastomer connector could be deformed and lose contact, resulting in missing pixels.
9. Static Electricity
  - a) Operator

Wear the electrostatics shielded clothes because human body may be statically charged if not ware shielded clothes. Never touch any of the conductive parts such as the LSI pads; the copper leads on the PCB and the interface terminals with any parts of the human body.
  - b) Equipment

There is a possibility that the static electricity is charged to the equipment, which has a function of peeling or friction action (ex: conveyer, soldering iron, working table). Earth the equipment through proper resistance (electrostatic earth:  $1 \times 10^8$  ohm).  
Only properly grounded soldering irons should be used.  
If an electric screwdriver is used, it should be well grounded and shielded from commutator sparks.  
The normal static prevention measures should be observed for work clothes and working benches; for the latter conductive (rubber) mat is recommended.
  - c) Floor

Floor is the important part to drain static electricity, which is generated by operators or equipment.  
There is a possibility that charged static electricity is not properly drained in case of insulating floor. Set the electrostatic earth (electrostatic earth:  $1 \times 10^8$  ohm).
  - d) Humidity

Proper humidity helps in reducing the chance of generating electrostatic charges. Humidity should be kept over 50%RH.
  - e) Transportation/storage

The storage materials also need to be anti-static treated because there is a possibility that the human body or storage materials such as containers may be statically charged by friction or peeling.  
The modules should be kept in antistatic bags or other containers resistant to static for storage.
  - f) Soldering

Solder only to the I/O terminals. Use only soldering irons with proper grounding and no leakage.  
Soldering temperature :  $280^{\circ} \text{C} \pm 10^{\circ} \text{C}$   
Soldering time: 3 to 4 sec.  
Use eutectic solder with resin flux fill.  
If flux is used, the LCD surface should be covered to avoid flux spatters. Flux residue should be removed afterwards.
  - g) Others

## ATM0231D2 (AZ DISPLAYS) TFT MODULE VER1.3

---

The laminator (protective film) is attached on the surface of LCD panel to prevent it from scratches or stains. It should be peeled off slowly using static eliminator.

Static eliminator should also be installed to the workbench to prevent LCD module from static charge.

### 10. Operation

- a) Driving voltage should be kept within specified range; excess voltage shortens display life.
  - b) Response time increases with decrease in temperature.
  - c) Display may turn black or dark blue at temperatures above its operational range; this is (however not pressing on the viewing area) may cause the segments to appear "fractured".
  - d) Mechanical disturbance during operation (such as pressing on the viewing area) may cause the segments to appear "fractured".
11. If any fluid leaks out of a damaged glass cell, wash off any human part that comes into contact with soap and water. The toxicity is extremely low but caution should be exercised at all the time.
  12. Disassembling the LCD module can cause permanent damage and it should be strictly avoided.
  13. LCD retains the display pattern when it is applied for long time (Image retention). To prevent image retention, do not apply the fixed pattern for a long time. Image retention is not a deterioration of LCD. It will be removed after display pattern is changed.
  14. Do not use any materials, which emit gas from epoxy resin (hardener for amine) and silicone adhesive agent (dealcohol or deoxym) to prevent discoloration of polarizer due to gas.
  15. Avoid the exposure of the module to the direct sunlight or strong ultraviolet light for a long time.

7. MECHANICAL DRAWING

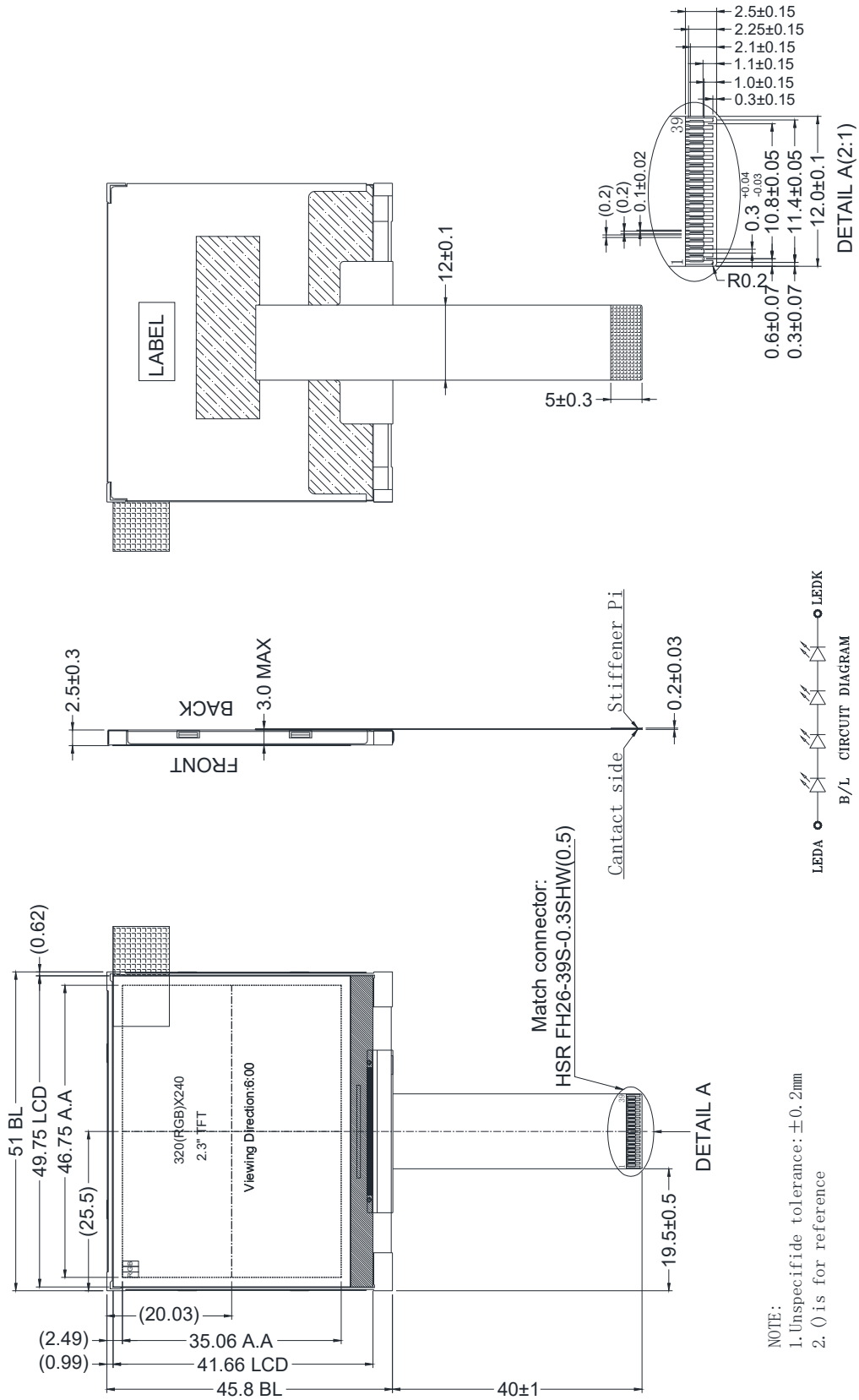



## 8. PACKAGE DRAWING

Packaging information: 512pcs/box

### Tray(ESD)

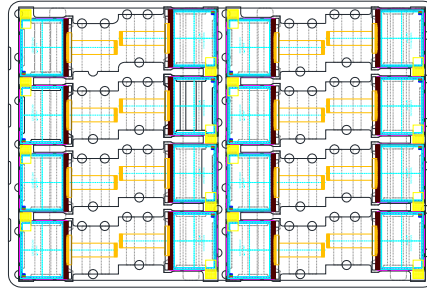

### Tray(ESD)

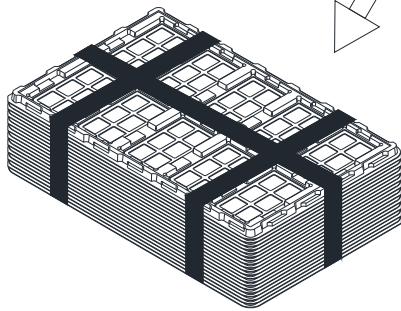

### Tray packing bag

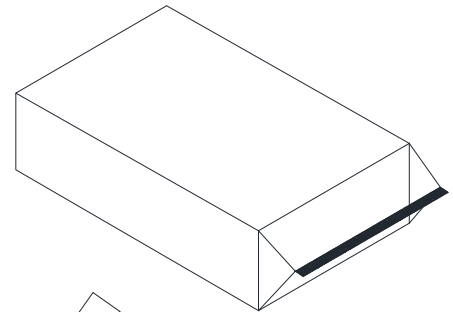

### Carton



## 9. INSPECTION SPECIFICATION

### 9.1.1 Inspection conditions

Inspection performed under the following conditions is recommended.

Temperature:  $25 \pm 5^\circ\text{C}$

Humidity:  $65\% \pm 10\% \text{RH}$

Viewing Angle: Normal viewing Angle ( $90^\circ \pm 45^\circ$ );

Illumination: Single fluorescent lamp (800~1200 LUX);

Viewing distance: 25-35cm, time: 5-10s;

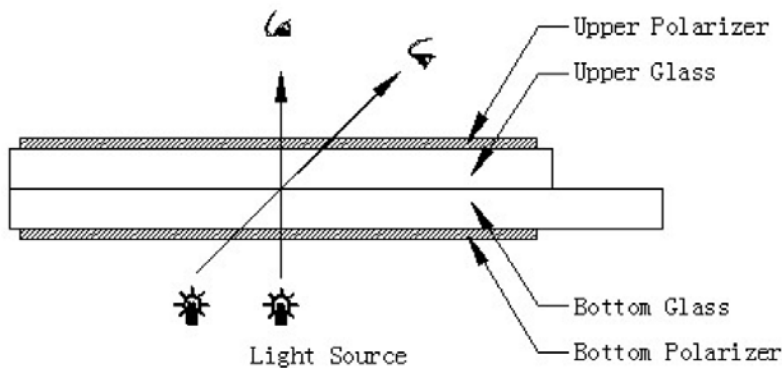

### 9.1.2 Definition

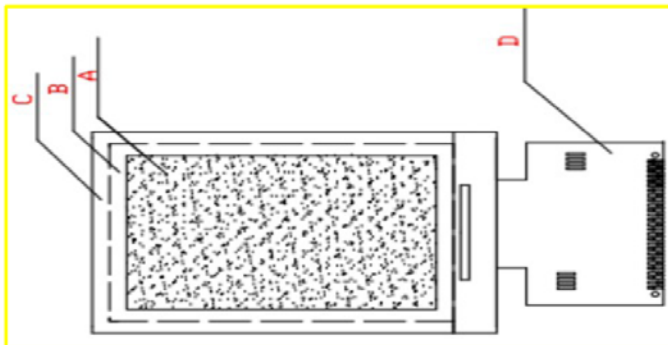

Zone A: LCD AA

Zone B: Viewing Area

Zone C: Outside of the Viewing Area

Note:

As a general rule, visual defects in Zone C can be ignored when it doesn't effect product function or appearance after assembly by customer.

### 9.1.3 Sampling Plan

According to GB/T 2828-2003; , normal inspection, Class II

AQL:

Major defect	Minor defect
0.65	1.5

LCD: Liquid Crystal Display, TP: Touch Panel, LCM: Liquid Crystal Module

**ATM0231D2 (AZ DISPLAYS) TFT MODULE VER1.3**

No	Items to be inspected	Criteria	Classification of defects
1	Functional defects	1) No display 2) Display abnormally 3) Missing vertical, horizontal segment 4) Short circuit 5) Back-light no lighting, flickering and abnormal lighting 6)Cross-Talk 7)Noise 8)Color contrast	Major
2	Missing	Missing component	Minor
3	Outline dimension	Overall outline dimension beyond the drawing is not allowed	
4	Color tone	Color unevenness, refer to limited sample	
5	Soldering appearance	Good soldering, Peeling off is not allowed.	Major
6	LCD/Polarizer	Black/White spot/line, scratch, crack, etc.	
7	mura	ND5%, 128 gray	Minor
8	Cross-talk	≤ 5%	Minor

**9.1.4 Criteria (Visual)**

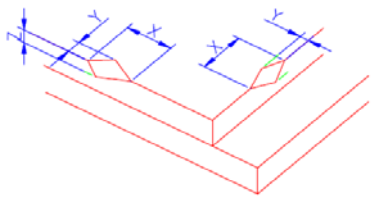
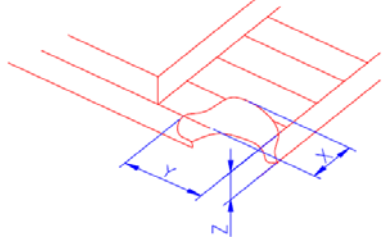
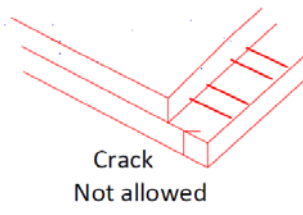
Number	Items	Criteria(mm)						
1.0 LCD Crack/Broken  NOTE: X: Length Y: Width Z: Height L: Length of ITO, T: Height of LCD	(1) The edge of LCD broken	 <table border="1" data-bbox="794 1187 1316 1339"> <thead> <tr> <th>X</th> <th>Y</th> <th>Z</th> </tr> </thead> <tbody> <tr> <td>≤1.5mm</td> <td>&lt;Inner border line of the seal</td> <td>≤T/2</td> </tr> </tbody> </table>	X	Y	Z	≤1.5mm	<Inner border line of the seal	≤T/2
	X	Y	Z					
	≤1.5mm	<Inner border line of the seal	≤T/2					
(2)LCD corner broken	 <table border="1" data-bbox="853 1612 1260 1684"> <thead> <tr> <th>X</th> <th>Y</th> <th>Z</th> </tr> </thead> <tbody> <tr> <td>≤3mm</td> <td>≤2mm</td> <td>≤T</td> </tr> </tbody> </table>	X	Y	Z	≤3mm	≤2mm	≤T	
X	Y	Z						
≤3mm	≤2mm	≤T						
(3) LCD crack	 <p align="center">Crack Not allowed</p>							

**ATM0231D2 (AZ DISPLAYS) TFT MODULE VER1.3**

Number	Items	Criteria (mm)																															
2.0	Spot defect	<p>① light dot (LCD/TP/Polarizer black/white spot, light dot, pinhole, dent, stain)</p> <table border="1"> <thead> <tr> <th rowspan="2">Zone Size (mm)</th> <th colspan="2">Acceptable Qty</th> </tr> <tr> <th>A</th> <th>B</th> </tr> </thead> <tbody> <tr> <td><math>\Phi \leq 0.10</math></td> <td colspan="2">Ignore</td> </tr> <tr> <td><math>0.10 &lt; \Phi \leq 0.15</math></td> <td colspan="2">1</td> </tr> <tr> <td><math>0.15 &lt; \Phi \leq 0.2</math></td> <td colspan="2">1</td> </tr> <tr> <td><math>0.2 &lt; \Phi</math></td> <td colspan="2">0</td> </tr> </tbody> </table> <p>② Dim spot (LCD/TP/Polarizer dim dot, light leakage, dark spot)</p> <table border="1"> <thead> <tr> <th rowspan="2">Zone Size (mm)</th> <th colspan="2">Acceptable Qty</th> </tr> <tr> <th>A</th> <th>B</th> </tr> </thead> <tbody> <tr> <td><math>\Phi \leq 0.1</math></td> <td colspan="2">Ignore</td> </tr> <tr> <td><math>0.1 &lt; \Phi \leq 0.2</math></td> <td colspan="2">1 (D &gt; 10mm)</td> </tr> <tr> <td><math>0.2 &lt; \Phi</math></td> <td colspan="2">0</td> </tr> </tbody> </table>	Zone Size (mm)	Acceptable Qty		A	B	$\Phi \leq 0.10$	Ignore		$0.10 < \Phi \leq 0.15$	1		$0.15 < \Phi \leq 0.2$	1		$0.2 < \Phi$	0		Zone Size (mm)	Acceptable Qty		A	B	$\Phi \leq 0.1$	Ignore		$0.1 < \Phi \leq 0.2$	1 (D > 10mm)		$0.2 < \Phi$	0	
	Zone Size (mm)	Acceptable Qty																															
A		B																															
$\Phi \leq 0.10$	Ignore																																
$0.10 < \Phi \leq 0.15$	1																																
$0.15 < \Phi \leq 0.2$	1																																
$0.2 < \Phi$	0																																
Zone Size (mm)	Acceptable Qty																																
	A	B																															
$\Phi \leq 0.1$	Ignore																																
$0.1 < \Phi \leq 0.2$	1 (D > 10mm)																																
$0.2 < \Phi$	0																																
	Line defect (LCD /Polarizer black/white line, scratch, stain)	<table border="1"> <thead> <tr> <th>Width(mm)</th> <th>Length(mm)</th> <th>Acceptable Qty</th> </tr> </thead> <tbody> <tr> <td><math>W \leq 0.03</math></td> <td>Ignore</td> <td>Ignore</td> </tr> <tr> <td><math>0.03 &lt; W \leq 0.05</math></td> <td><math>L \leq 3</math></td> <td>1</td> </tr> <tr> <td><math>0.05 &lt; W \leq 0.1</math></td> <td><math>L \leq 2</math></td> <td>1</td> </tr> </tbody> </table>	Width(mm)	Length(mm)	Acceptable Qty	$W \leq 0.03$	Ignore	Ignore	$0.03 < W \leq 0.05$	$L \leq 3$	1	$0.05 < W \leq 0.1$	$L \leq 2$	1																			
Width(mm)	Length(mm)	Acceptable Qty																															
$W \leq 0.03$	Ignore	Ignore																															
$0.03 < W \leq 0.05$	$L \leq 3$	1																															
$0.05 < W \leq 0.1$	$L \leq 2$	1																															
3.0	Polarizer scratch	<table border="1"> <thead> <tr> <th>Width(mm)</th> <th>Length(mm)</th> <th>Acceptable Qty</th> </tr> </thead> <tbody> <tr> <td><math>W \leq 0.03</math></td> <td><math>L \leq 5</math></td> <td>2</td> </tr> <tr> <td><math>0.03 &lt; W \leq 0.05</math></td> <td><math>L \leq 3</math></td> <td>1</td> </tr> <tr> <td><math>0.05 &lt; W</math></td> <td>0</td> <td>0</td> </tr> </tbody> </table>	Width(mm)	Length(mm)	Acceptable Qty	$W \leq 0.03$	$L \leq 5$	2	$0.03 < W \leq 0.05$	$L \leq 3$	1	$0.05 < W$	0	0																			
Width(mm)	Length(mm)	Acceptable Qty																															
$W \leq 0.03$	$L \leq 5$	2																															
$0.03 < W \leq 0.05$	$L \leq 3$	1																															
$0.05 < W$	0	0																															

## ATM0231D2 (AZ DISPLAYS) TFT MODULE VER1.3

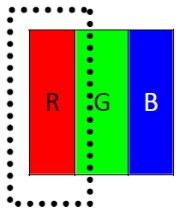
	Polarizer Bubble	<table border="1" style="margin: auto; border-collapse: collapse;"> <tr> <td style="width: 30%; text-align: center;">Zone Size (mm)</td> <td style="width: 70%; text-align: center;">Acceptable Qty</td> </tr> <tr> <td style="text-align: center;"><math>\Phi \leq 0.1</math></td> <td style="text-align: center;">3</td> </tr> <tr> <td style="text-align: center;"><math>0.1 &lt; \Phi \leq 0.2</math></td> <td style="text-align: center;">2 (<math>D \geq 15\text{mm}</math>)</td> </tr> <tr> <td style="text-align: center;"><math>0.2 &lt; \Phi</math></td> <td style="text-align: center;">0</td> </tr> </table>	Zone Size (mm)	Acceptable Qty	$\Phi \leq 0.1$	3	$0.1 < \Phi \leq 0.2$	2 ( $D \geq 15\text{mm}$ )	$0.2 < \Phi$	0						
Zone Size (mm)	Acceptable Qty															
$\Phi \leq 0.1$	3															
$0.1 < \Phi \leq 0.2$	2 ( $D \geq 15\text{mm}$ )															
$0.2 < \Phi$	0															
4.0	SMT	According to the <Acceptability of electronic assemblies> IPC-A-610C class 2 standard. Component missing or function defect are Major defect, the others are Minor defect.														
5.0	TFT	<table border="1" style="margin: auto; border-collapse: collapse;"> <thead> <tr> <th>distinguish</th> <th>type</th> <th>Acceptable Qty</th> </tr> </thead> <tbody> <tr> <td rowspan="2" style="text-align: center;">Bright dot</td> <td style="text-align: center;">Any color window</td> <td style="text-align: center;">0</td> </tr> <tr> <td style="text-align: center;">Adjacent Bright dot</td> <td style="text-align: center;">0</td> </tr> <tr> <td rowspan="2" style="text-align: center;">Dark dot</td> <td style="text-align: center;">Dark dot</td> <td style="text-align: center;">2</td> </tr> <tr> <td style="text-align: center;">Adjacent Dark dot</td> <td style="text-align: center;">0</td> </tr> </tbody> </table> <p>Note: the red (R), green, blue (G), (B) 3 points constitute a pixel</p> <p>Note :Visible under ND6%(6%的滤光片确认)</p>	distinguish	type	Acceptable Qty	Bright dot	Any color window	0	Adjacent Bright dot	0	Dark dot	Dark dot	2	Adjacent Dark dot	0	 <p style="text-align: center;">Dot</p>
distinguish	type	Acceptable Qty														
Bright dot	Any color window	0														
	Adjacent Bright dot	0														
Dark dot	Dark dot	2														
	Adjacent Dark dot	0														