

Sure Cross® QM30VT2 Vibration and Temperature Sensor

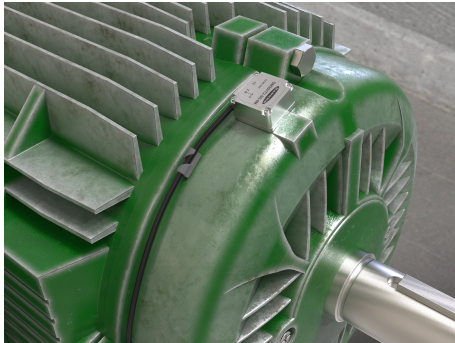

Datasheet

Continuously monitor machine health, run time, and detect unexpected machine failures such as early bearing failure, unbalance, misalignment, etc. with the Sure Cross Vibration and Temperature QM30VT2 Sensor. The QM30VT2 works in a variety of machines to identify and predict failures in rotating components. Paired with a Sure Cross wireless radio, the QM30VT2 becomes the ultimate predictive maintenance tool for wireless vibration and temperature monitoring.



- Detects dual-axis vibration up to 4 kHz bandwidth
- Output actionable data such as RMS Velocity, RMS High Frequency Acceleration, Peak Velocity, etc. which is pre-processed from the vibration waveforms in the sensor
- Provides high accuracy vibration and temperature measurements
- Industrial grade sensor with small form factor to fit in the tightest locations
- Manufactured with stainless steel or aluminum housing, depending on the model
- Connects to a MultiHop Modbus radio or any Modbus network for easy set up and installation, even in the hardest to reach and rugged locations
- Functions as a Modbus slave device via RS-485

For additional information, updated documentation, and a list of accessories, refer to Banner Engineering's website, www.bannerengineering.com.

Models

Model	Housing Type	Connections and Cable	I/O
QM30VT2-SS-9M	316L Stainless Steel	9.1 m (30 ft) Flying Leads	Vibration and temperature via RS-485 Modbus
QM30VT2-SS-QP		150 mm (6 in) cable with a 5-pin M12 male quick disconnect (QD)	
QM30VT2	Aluminum	2.09 m (6.85 ft) cable with a 5-pin M12 male quick disconnect (QD)	
QM30VT2-QP		150 mm (6 in) cable with a 5-pin M12 male quick disconnect (QD)	

The Sensor Configuration Software offers an easy way to manage sensor parameters, retrieve data, and visually show sensor data from a number of different sensors. The Sensor Configuration Software runs on any Windows machine and uses an adapter cable to connect the sensor to your computer. Download the most recent version of the software from Banner Engineering's website: www.bannerengineering.com and select **Software** from the **Products** drop-down list.

Configure this sensor using the [Sensor Configuration Software](#) (instruction manual p/n 170002) and USB to RS-485 adapter cable model **BWA-UCT-900** (datasheet p/n 140377). When updating the firmware, you must use one of the two USB to RS-485 adapter cables.

Holding Registers

Aliased register addresses are user configurable. Aliased addressed registers are sequenced to be read with one single Modbus read.

Modbus Register Alias Address	Modbus Register Address	Description	I/O Range		Holding Register Representation	
			Min	Max	Min (dec)	Max (dec)
45201	42401	Z-Axis RMS Velocity (in/sec) ^{1, 5}	0	6.5535	0	65535
45202	42403	Z-Axis RMS Velocity (mm/sec) ^{2, 5}	0	65.535	0	65535
45203	40049	Temperature (°F) ³	-327.68	327.67	-32768	32767
45204	40043	Temperature (°C) ³	-327.68	327.67	-32768	32767
45205	42451	X-Axis RMS Velocity (in/sec) ^{1, 5}	0	6.5535	0	65535
45206	42453	X-Axis RMS Velocity (mm/sec) ^{2, 5}	0	65.535	0	65535
45207	42407	Z-Axis Peak Acceleration (G) ^{2, 6}	0	65.535	0	65535
45208	42457	X-Axis Peak Acceleration (G) ^{2, 6}	0	65.535	0	65535
45209	42405	Z-Axis Peak Velocity Component Frequency (Hz) ^{4, 5}	0	6553.5	0	65535



Modbus Register Alias Address	Modbus Register Address	Description	I/O Range		Holding Register Representation	
			Min	Max	Min (dec)	Max (dec)
45210	42455	X-Axis Peak Velocity Component Frequency (Hz) ^{4, 5}	0	6553.5	0	65535
45211	42406	Z-Axis RMS Acceleration (G) ^{2, 5}	0	65.535	0	65535
45212	42456	X-Axis RMS Acceleration (G) ^{2, 5}	0	65.535	0	65535
45213	42409	Z-Axis Kurtosis ^{2, 6}	0	65.535	0	65535
45214	42459	X-Axis Kurtosis ^{2, 6}	0	65.535	0	65535
45215	42408	Z-Axis Crest Factor ^{2, 6}	0	65.535	0	65535
45216	42458	X-Axis Crest Factor ^{2, 6}	0	65.535	0	65535
45217	42402	Z-Axis Peak Velocity (in/sec) ^{1, 5}	0	6.5535	0	65535
45218	42404	Z-Axis Peak Velocity (mm/sec) ^{2, 5}	0	65.535	0	65535
45219	42452	X-Axis Peak Velocity (in/sec) ^{1, 5}	0	6.5535	0	65535
45220	42454	X-Axis Peak Velocity (mm/sec) ^{2, 5}	0	65.535	0	65535
45221	42410	Z-Axis High-Frequency RMS Acceleration (G) ^{2, 6}	0	65.535	0	65535
45222	42460	X-Axis High-Frequency RMS Acceleration (G) ^{2, 6}	0	65.535	0	65535
	46101	Baud	0=9.6k, 1=19.2k (default), 2=38.4k			
	46102	Parity	0=none (default), 1=odd, 2=even			
	46103	Modbus Slave Address	1 (default) through 247			
	42601	Rotational Speed (RPM) (default = 1725 RPM) -- Used in vibration spectral band measurements	0	65535	0	65535
	42602	Rotational Speed (Hz) (default = 29 Hz) -- Used in vibration spectral band measurements	0	65535	0	65535

- ¹ Value = Register value ÷ 10000
- ² Value = Register value ÷ 1000
- ³ Value = Register value ÷ 100

- ⁴ Value = Register value ÷ 10
- ⁵ Measurement bandwidth = 10 Hz to 1 kHz
- ⁶ Measurement bandwidth = 1 kHz to 4 kHz

By default, data is sampled every five seconds. The minimum recommended sample rate is three seconds. Use the Sensor Configuration Tool to adjust the sensor's sample rate if a different value is needed.

Temperature values outside of the operating range of the device are forced to the maximum or minimum values.

Installation Instructions

Connecting the Vibration/Temperature Sensor

To install the sensor to a device with a 5-pin M12 female connector:

1. Align the notch in the female connector with the key in the sensor's male connector.
2. Gently slide the sensor end into the connector.
3. Rotate the threaded nut to tighten the sensor down.

Wiring

This sensor is designed for use as a Modbus slave. This sensor can be plugged into any Modbus RS-485 network, including compatible MultiHop Data Radios. Flying lead models use the listed wire colors and sensor connections.

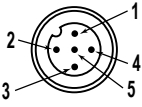
5-pin M12 Male Connector	Pin	Wire Color	Sensor Connection
	1	brown (bn)	Power IN (+): 10 to 30 V DC
	2	white (wh)	RS485 / D1 / B / +
	3	blue (bu)	Ground (-)
	4	black (bk)	RS485 / D0 / A / -
	5	gray (gy)	Not Used. When updating the firmware, you must ground pin 5 by connecting it to pin 3.

Installing the QM30VTx Sensor

The vibration sensors have an X and Z axis indication on the face of the sensor. Install the X axis (parallel to sensor) in line with the shaft of the motor or axially. Install the Z axis (plane of the sensor) to go into or through the motor or radial.

For the best results, install the sensor as close to the motor bearing as possible. If this is not possible, install the sensor on a surface that is in rigid connection with vibration characteristics of the motor. Using a cover shroud or other flexible mounting location may result in reduced accuracy or reduced ability to detect certain vibration characteristics. After determining the sensor direction and location, mount the sensor for the best possible vibration sensing accuracy.

Figure 1. Installation direction

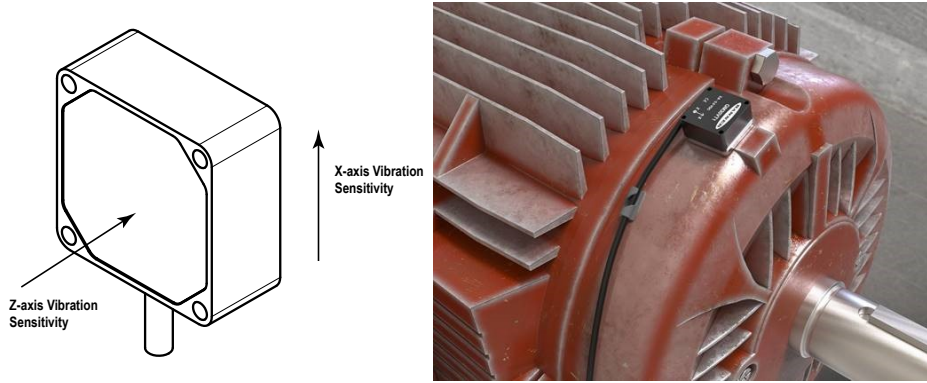

Mounting Options	QM30 Housing Type	Description
BWA-QM30-FTAL	Aluminum	When available, directly mounting the bracket to the motor using an 1/4-28 × 1/2-inch screw provides a rigid surface with the highest sensor accuracy and frequency response. This mounting option offers flexibility for future sensor and bracket movement.
BWA-QM30-FTSS	Stainless steel	Another mounting option is to use an epoxy to adhere the bracket to the motor. Banner recommends using an epoxy designed for accelerometer mounting, such as Loctite Depend 330 and 7388 activator. Epoxying a bracket to a motor provides a permanent installation of the bracket to which the sensor can be attached. This more rigid mounting solution ensures some of the best sensor accuracy and frequency response, but is not flexible for future adjustments. A third option is to use the included thermally conductive adhesive tape. This often provides a more than sufficient mounting type but does introduce some additional flex that reduces accuracy.
BWA-QM30-CEAL Curved bracket epoxied to the motor	Aluminum	This lightweight aluminum bracket provides a close connection to the motor with ridges to sit on curved surfaces and ensure a tight fit. The bracket is epoxied to the motor and the sensor is screwed into the bracket.
BWA-QM30-FMSS Flat magnet bracket	Aluminum and stainless steel	Gives a solid, strong, and adjustable mount to a motor, but with a motor's curved surface it may not provide the best connection if the motor is too small for the magnet to get a full connection with the motor housing. Magnet mounts are susceptible to accident rotation or a change in the sensor location if an outside force bumps or moves the sensor. This can lead to a change in sensor information that differs from the time-trended data from the previous location. The bracket is stainless steel and the magnet insert is neodymium.
BWA-QM30-CMAL Curved surface magnet bracket	Aluminum and stainless steel	Gives a solid, strong, and adjustable mount to a motor, intended for use when the flat magnetic bracket does not make a good connection with the motor's surface. Magnet mounts are susceptible to accidental rotation or change in the sensor location if an outside force bumps or moves the sensor. This can lead to a change in the sensor information that differs from the time-trended data from the previous location. The bracket is aluminum and the magnet insert is samarium-cobalt.
BWA-QM30-FSALR	Aluminum	This larger aluminum bracket mounts to the motor with a 1/4-28 × 1/2-inch screw to provide a rigid connection to the motor. On the right or left side, a set-screw is hand-tightened to secure the sensor to the bracket, allowing for rapid release and installation of a sensor compared to other mounting options.
BWA-QM30-FSSSR	Stainless steel	This larger stainless steel bracket mounts to the motor with a 1/4-28 × 1/2-inch screw to provide a rigid connection to the motor. A set-screw is hand-tightened to secure the sensor to the bracket, allowing for rapid release and installation of a sensor compared to other mounting options.

Specifications

Supply Voltage

10 V DC to 30 V DC

Current

Active comms: 9 mA at 30 V DC

Communication

Interface: RS-485 serial
 Baud rates: 9.6k, 19.2k (default), or 38.4k
 Data format: 8 data bits, no parity (default), 1 stop bit (even or odd parity available)
 Protocol: Modbus RTU

Mounting Options

The sensor can be mounted using a variety of methods, including M4 × 0.7 hex screw, epoxy, thermal tape, or magnetic mount.

Mechanical Shock

MIL-STD-202G, Method 213B, Condition I (100G 6x along X, Y, and Z axes, 18 shocks), with device operating

Certifications



Vibration Sensor

Measuring Range: 0 to 46 mm/sec or 0 to 1.8 in/sec RMS
 Frequency Range: 10 Hz to 4 kHz
 Accuracy: ±10% at 25 °C
 Sampling Frequency: 20 kHz (default)
 Record Length: 8192 points (default)
 Sample Duration: 0.4 s (default)

Temperature Sensor

Measuring Range: -40 °C to +105 °C (-40 °F to +221 °F)
 Resolution: 1 °C
 Accuracy: ± 3 °C
 Operating the sensor at higher voltages can induce internal heating that can reduce the accuracy.

Environmental Rating

Stainless steel model: IP69K per DIN 40050-9
 Aluminium model: IP67

Operating Temperature

-40 °C to +105 °C (-40 °F to +221 °F) [¶]



WARNING:

- **Do not use this device for personnel protection**
- Using this device for personnel protection could result in serious injury or death.
- This device does not include the self-checking redundant circuitry necessary to allow its use in personnel safety applications. A device failure or malfunction can cause either an energized (on) or de-energized (off) output condition.

Vibration Severity Per ISO 10816

ISO 10816 provides guidance for evaluating vibration velocity severity motors, pumps, fans, compressors, gear boxes, blowers, dryers, presses, and other machines that operate in the 10 to 1000 Hz frequency range.

Figure 2. Vibration Severity per ISO 10816

	Machine		Class I	Class II	Class III	Class IV
	in/s	mm/s	Small Machines	Medium Machines	Large Rigid Foundation	Large Soft Foundation
Vibration Velocity Vrms	0.01	0.28				
	0.02	0.45				
	0.03	0.71		good		
	0.04	1.12				
	0.07	1.80				
	0.11	2.80		satisfactory		
	0.18	4.50				
	0.28	7.10		unsatisfactory		
	0.44	11.2				
	0.70	18.0				
	1.10	28.0		unacceptable		
	1.77	45.9				

Vibration Spectral Band Measurements

To use vibration spectral band measurements, follow the instructions in the Vibration Spectral Band Measurement Start Guide (p/n [b_4510565](#)).

[¶] Operating the devices at the maximum operating conditions for extended periods can shorten the life of the device.

Dimensions

All measurements are listed in millimeters [inches], unless noted otherwise.

Figure 3. Aluminium model

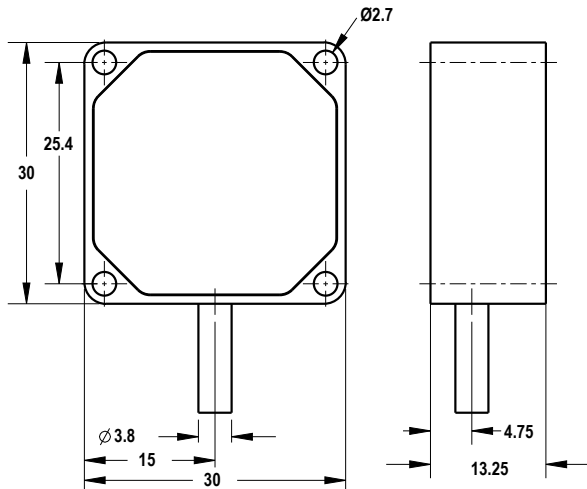
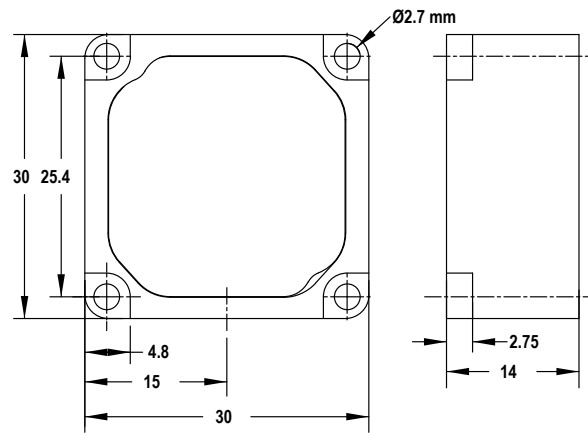

Figure 4. Stainless steel models



Accessories

Brackets

Bracket **BWA-QM30-FTAL** is included with the aluminium sensor models. Bracket **BWA-QM30-FTSS** is included with the stainless steel models. All other brackets are available for order, but are not included with the sensor.

BWA-QM30-FTSS

- Use when measuring high frequency vibrations or when mounting the sensor to curved surfaces
- Includes **SMBQM30** stainless steel bracket, four mounting screws, and one ¼-28 × 1/2 screw mount
- 30 mm × 30 mm
- **Refer to the Bracket Assembly Quick Start Guide for installation instructions (p/n 213323)**

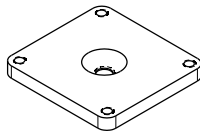

BWA-QM30-FMSS

- Includes magnetic mounting bracket **SMBQM30** and four mounting screws (two sets of mounting screws for both the aluminum and stainless steel models)
- 30 mm × 30 mm
- **Refer to the Bracket Assembly Quick Start Guide for installation instructions (p/n 213323)**

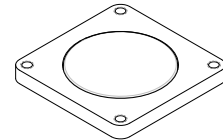

BWA-QM30-FTAL

- Use when measuring high frequency vibrations or when mounting the sensor to curved surfaces
- Includes **SMBQM30** aluminum bracket, four mounting screws, one ¼-28 × 1/2 screw mount, and one piece of 3M™ thermally conductive adhesive transfer tape
- 30 mm × 30 mm
- **Refer to the Bracket Assembly Quick Start Guide for installation instructions (p/n 213323)**

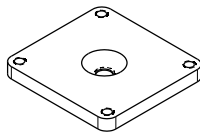

BWA-QM30-CMAL

- Magnet mount for curved surfaces
- 30 mm × 30 mm, 14.4 mm thick
- Includes four M2.5 × 16 mm socket head cap screws
- **Refer to the Bracket Assembly Quick Start Guide for installation instructions (p/n 213323)**

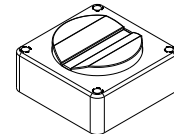

BWA-QM30-CEAL

- Glue-mount for curved surfaces
- Aluminum

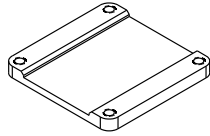

BWA-QM30-FSALR Flat Surface Rapid Release Bracket (Aluminum)

- Aluminum
- Circular bracket with center screw for mounting the bracket to the motor
- Side set-screw for quick release mounting of the sensor to the bracket

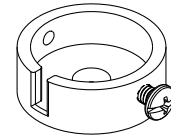

BWA-QM30-FSSSR Flat Surface Rapid Release Bracket (Stainless Steel)

- Stainless steel
- Circular bracket with center screw for mounting the bracket to the motor
- Side set-screw for quick release mounting of the sensor to the bracket

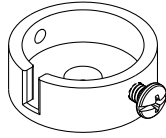

Cordsets

5-Pin Threaded M12 Cordsets—Single Ended				
Model	Length	Style	Dimensions	Pinout (Female)
MQDC1-501.5	0.5 m (1.5 ft)	Straight		<p>1 = Brown 2 = White 3 = Blue 4 = Black 5 = Gray</p>
MQDC1-503	0.9 m (2.9 ft)			
MQDC1-506	2 m (6.5 ft)			
MQDC1-515	5 m (16.4 ft)			
MQDC1-530	9 m (29.5 ft)			
MQDC1-560	18 m (59 ft)			
MQDC1-506RA	2 m (6.5 ft)	Right-Angle		<p>1 = Brown 2 = White 3 = Blue 4 = Black 5 = Gray</p>
MQDC1-515RA	5 m (16.4 ft)			
MQDC1-530RA	9 m (29.5 ft)			
MQDC1-560RA	19 m (62.3 ft)			

5-Pin Threaded M12 Cordsets—Double Ended					
Model	Length	Style	Dimensions	Pinout (Male)	Pinout (Female)
MQDEC-501SS	0.31 m (1.02 ft)	Male Straight/ Female Straight		<p>1 = Brown 2 = White 3 = Blue</p>	<p>4 = Black 5 = Gray</p>
MQDEC-503SS	0.91 m (2.99 ft)				
MQDEC-506SS	1.83 m (6 ft)				
MQDEC-512SS	3.66 m (12 ft)				
MQDEC-515SS	5 m (16.4 ft)				
MQDEC-530SS	9 m (29.5 ft)				
MQDEC-550SS	15 m (49.2 ft)				

5-Pin M12 Shielded Twisted Pair Cordsets—Single Ended				
Model	Length	Style	Dimensions	Pinout (Female)
MQDC-STP-501	0.31 m (1 ft)	Straight		<p>1 = Brown 2 = White 3 = Blue 4 = Black 5 = Shield</p>
MQDC-STP-503	0.92 m (3 ft)			
MQDC-STP-506	1.83 m (6 ft)			
MQDC-STP-515	4.57 m (15 ft)			
MQDC-STP-530	9.15 m (30 ft)			

5-Pin Threaded M12 Shielded Twisted Pair Cordsets—Double Ended					
Model	Length	Style	Dimensions	Pinout (Male)	Pinout (Female)
MQDEC-STP-501SS	0.31 m (1 ft)	Male Straight/ Female Straight			
MQDEC-STP-503SS	0.91 m (2.99 ft)				
MQDEC-STP-506SS	1.83 m (6 ft)				
MQDEC-STP-515SS	4.58 m (15 ft)			<p>1 = Brown 2 = White 3 = Blue</p>	<p>4 = Black 5 = Shield</p>
MQDEC-STP-530SS	10 m (32.8 ft)				
MQDEC-STP-550SS	15 m (49.2 ft)				

5-Pin Threaded M12 Stainless Steel Washdown Cordsets—Single Ended				
Model	Length	Style	Dimensions	Pinout (Female)
MQDC-WDSS-0506	2 m (6.56 ft)	Straight		<p>1 = Brown 2 = White 3 = Blue 4 = Black 5 = Gray</p>
MQDC-WDSS-0515	5 m (16.4 ft)			
MQDC-WDSS-0530	9 m (29.5 ft)			

5-Pin Threaded M12 Stainless Steel Washdown Cordsets—Double Ended					
Model	Length	Style	Dimensions	Pinout (Male)	Pinout (Female)
MQDEC-WDSS-505SS	1.52 m (4.99 ft)	Male Straight/ Female Straight			
MQDEC-WDSS-510SS	3.05 m (10 ft)				
MQDEC-WDSS-515SS	4.57 m (15 ft)				

5-Pin Threaded M12 Splitter Tee				
Model	Description		Pinout (Male)	Pinout (Female)
CSB-M1250M1250-T	Female trunk, 1 female branch, 1 male branch		<p>1 = Brown 2 = White 3 = Blue</p>	<p>4 = Black 5 = Green/Yellow</p>

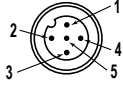
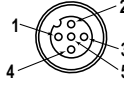
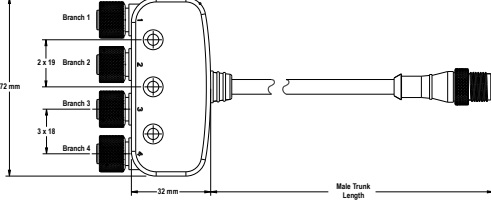
5-Pin Threaded M12 Splitter Cordset with Flat Junction—Double Ended				
Model	Trunk (Male)	Branches (Female)	Pinout (Male)	Pinout (Female)
CSB4-M1251M1250	0.3 m (0.98 ft)	Four (no cable)		
			1 = Brown 2 = White 3 = Blue	4 = Black 5 = Gray

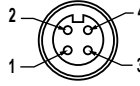
4-Pin Threaded M12 RS-485 to USB Adapter Cordset, with Wall Plug				
Model	Length	Style	Dimensions	Pinout (Female)
BWA-UCT-900	1 m (3.28 ft)	Straight		 1 = Brown 2 = White 3 = Blue 4 = Black

Banner Engineering Corp. Limited Warranty

Banner Engineering Corp. warrants its products to be free from defects in material and workmanship for one year following the date of shipment. Banner Engineering Corp. will repair or replace, free of charge, any product of its manufacture which, at the time it is returned to the factory, is found to have been defective during the warranty period. This warranty does not cover damage or liability for misuse, abuse, or the improper application or installation of the Banner product.

THIS LIMITED WARRANTY IS EXCLUSIVE AND IN LIEU OF ALL OTHER WARRANTIES WHETHER EXPRESS OR IMPLIED (INCLUDING, WITHOUT LIMITATION, ANY WARRANTY OF MERCHANTABILITY OR FITNESS FOR A PARTICULAR PURPOSE), AND WHETHER ARISING UNDER COURSE OF PERFORMANCE, COURSE OF DEALING OR TRADE USAGE.

This Warranty is exclusive and limited to repair or, at the discretion of Banner Engineering Corp., replacement. **IN NO EVENT SHALL BANNER ENGINEERING CORP. BE LIABLE TO BUYER OR ANY OTHER PERSON OR ENTITY FOR ANY EXTRA COSTS, EXPENSES, LOSSES, LOSS OF PROFITS, OR ANY INCIDENTAL, CONSEQUENTIAL OR SPECIAL DAMAGES RESULTING FROM ANY PRODUCT DEFECT OR FROM THE USE OR INABILITY TO USE THE PRODUCT, WHETHER ARISING IN CONTRACT OR WARRANTY, STATUTE, TORT, STRICT LIABILITY, NEGLIGENCE, OR OTHERWISE.**

Banner Engineering Corp. reserves the right to change, modify or improve the design of the product without assuming any obligations or liabilities relating to any product previously manufactured by Banner Engineering Corp. Any misuse, abuse, or improper application or installation of this product or use of the product for personal protection applications when the product is identified as not intended for such purposes will void the product warranty. Any modifications to this product without prior express approval by Banner Engineering Corp will void the product warranties. All specifications published in this document are subject to change; Banner reserves the right to modify product specifications or update documentation at any time. Specifications and product information in English supersede that which is provided in any other language. For the most recent version of any documentation, refer to:

www.bannerengineering.com.

For patent information, see www.bannerengineering.com/patents.

FCC Part 15

This device complies with Part 15 of the FCC Rules. This equipment generates, uses, and can radiate radio frequency energy and, if not installed and used in accordance with the instruction manual, may cause harmful interference to radio communications. Operation is subject to the following two conditions: 1) This device may not cause harmful interference; and 2) This device must accept any interference received, including interference that may cause undesired operation.

Industry Canada

This device complies with CAN ICES-3 (A)/NMB-3(A). Operation is subject to the following two conditions: 1) This device may not cause harmful interference; and 2) This device must accept any interference received, including interference that may cause undesired operation.

Cet appareil est conforme à la norme NMB-3(A). Le fonctionnement est soumis aux deux conditions suivantes : (1) ce dispositif ne peut pas occasionner d'interférences, et (2) il doit tolérer toute interférence, y compris celles susceptibles de provoquer un fonctionnement non souhaité du dispositif.