

Indicator



PSE M16 AE PI Indicator

See below:

[Approvals and Compliances](#)

Description

- The indicators are available with point illumination
- Can be combined with the available piezo switch variants
- Crimp terminal male

Unique Selling Proposition

- Variety of design options regarding size, colour, material and connections
- High reliability, long lifetime

Characteristics

- For use in harsh environments, both indoors and outdoors (see technical data)

References

- Alternative: Other diameter [PSE AE 30](#)
- Alternative: switch normal operation:

Weblinks

- [pdf data sheet](#), [html datasheet](#), [General Product Information](#), [CAD-Drawings](#), [Product News](#), [Detailed request for product](#)

Technical Data

Electrical Data

ESD-protection-class	8 kV Class 3B
Supply Voltage	Point Illumination without series resistor

Mechanical Data

Mounting screw torque	2.5 Nm
Shock Protection	IK08

Climatical Data

Operating Temperature	-40 to 85 °C
Storage Temperature	-40 to 85 °C
IP-Protection	IP67 acc. to IEC 60529, IP69K acc. to DIN 40050-9
Environmental Assessment	+55°C / 93% r.h. acc. to DIN EN 60068-2-30
Salt Spray Test (acc. to DIN 50021-SS)	24 h / 48 h / 96 h Residence Time

Material

Housing	Aluminium anodized
Seal Ring	NBR70
Nut	Steel galvanized



Approvals and Compliances

Detailed information on product approvals, code requirements, usage instructions and detailed test conditions can be looked up in [Details about Approvals](#)

SCHURTER products are designed for use in industrial environments. They have approvals from independent testing bodies according to national and international standards. Products with specific characteristics and requirements such as required in the automotive sector according to IATF 16949, medical technology according to ISO 13485 or in the aerospace industry can be offered exclusively with customer-specific, individual agreements by SCHURTER.



Application standards

Application standards where the product can be used

Organization	Design	Standard	Description
	Designed for applications acc.	MIL-STD:	202F Method 107G, 202F Method 204D, 202F Method 213B, 416D Method RS103, 810E Method 501.3, 810E Method 502.3, 810E Method 507.3
	Designed for applications acc.	VDE Certificate Number:	DIN EN 61000-4-2, DIN EN 61000-4-4, DIN EN 61000-4-5
	Designed for applications acc.	IEC/UL 62368-1	Audio/video, information and communication technology equipment - Part 1: Safety requirements

Compliances

The product complies with following Guide Lines

Identification	Details	Initiator	Description
	RoHS	SCHURTER AG	Directive RoHS 2011/65/EU, Amendment (EU) 2015/863
	REACH	SCHURTER AG	On 1 June 2007, Regulation (EC) No 1907/2006 on the Registration, Evaluation, Authorization and Restriction of Chemicals 1 (abbreviated as "REACH") entered into force.

Dimension [mm]

PSE AE M16 PI

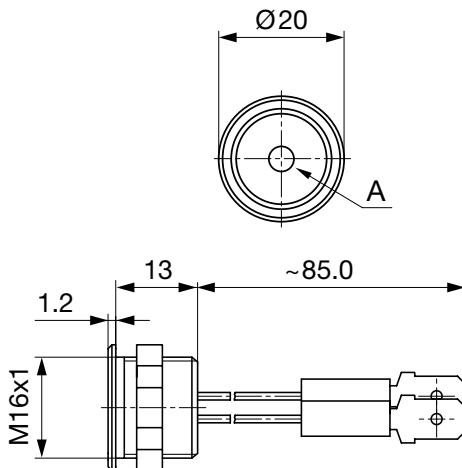

Dimension

PSE 16

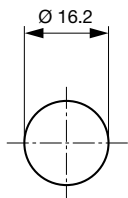

Drilling diagram

Diagrams

PSE AE PI

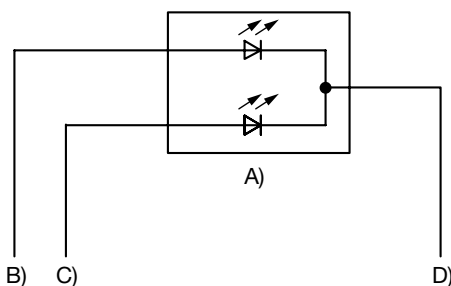

- A) Double-LED (2 colors, 3 pins) or simple LED (2 pins)
- B) Cable 1 (color 1 of the LED), Supply voltage
- C) Cable 2 (color 2 of the LED), Supply voltage
- D) Cable 3 (black), Mass

Point Illumination

Operating Data	Forward Current max.	Forward Voltage at 10 mA	Forward Voltage max.
LED red	25 mA	2.1 VDC	2.5 VDC
LED green	25 mA	2.05 VDC	2.5 VDC
LED yellow	30 mA	2.0 VDC	2.5 VDC

Attention: Point illuminated Indicators are delivered without series resistor.

All Variants

Mounting Diameter [mm]	Terminal	Housing Material, Torsion Protection	Colour of Housing	Surface Finish	Shock Protection	Illumination, LED	Config. Code	Order Number
16	Quick connect terminal	Aluminium anodized ,no	Alu natural	F	IK08	Point Illumination, red	PSE M 16 AE	1241.3033.M
16	Quick connect terminal	Aluminium anodized ,no	Alu natural	F	IK08	Point Illumination, green	PSE M 16 AE	1241.3034.M

Legende:
 Type: PSE
 AE = Indicator
 RU = Pl = Point Illumination
 RI = Ring Illumination
 AI = Area Illumination
 Alu = Aluminium
 ES = Stainless steel
 IF = Finger guidance
 E = without finger guidance

Nut with gasket are enclosed in the box.

Other mounting diameters, materials, colors, connections, supply voltages possible available on request.
 Special materials e.g. Marine grade stainless steel for use in salt and chlorinated environment on request.

Availability for all products can be searched real-time: <https://www.schurter.com/en/Stock-Check/Stock-Check-SCHURTER>

Packaging unit

10 Pcs



- Indicator elements in ESD safe packaging
- Screw nuts and sealing rings in a bag (enclosed in the box)