

Touchless Switch



See below:
[Approvals and Compliances](#)

Description

- Touchless momentary push button (MO¹) or as latching switch (LA)
- Protection against unintended switching
- Precise operating
- Potential free output contacts
- Laser lettering possible
- Vandal resistant

Unique Selling Proposition

- Variable supply voltage, RGB with integrated series resistor
- High reliability
- Wiping and cleaning the surface does not trigger a switching operation

Characteristics

- Housing made from stainless steel
- With ring illumination
- Wearless, no moving parts
- Attractive design
- Insensitive to water and rain

Weblinks

[pdf data sheet](#), [html datasheet](#), [General Product Information](#), [CAD-Drawings](#), [Product News](#), [Detailed request for product](#), [Landing Page](#)

Technical Data

Electrical Data

Switching Function	Momentary (MO ¹) or latching (LA)
Switching Voltage	max. 42 VAC / 60 VDC
Switching current	max. 100 mA
Electrical Rating	1 W
Switch Resistance OFF	> 10 MΩ
Switch Resistance ON	< 16 Ω
Supply Voltage LED	5 - 28 VDC
Current Consumption all LEDs off	6.0 mA (typ) / 13.0 mA (max) Peak: 29 mA (switch is closed) 8.0 mA (typ) / 15.0 mA (max) Peak: 34 mA (switch is open)
Current Consumption Illumination red, green or blue	10.0 mA (typ) / 17.0 mA (max) Peak: 34 mA (switch is closed) 11.0 mA (typ) / 19.0 mA (max) Peak: 38 mA (switch is open)
Current Consumption Illumination yellow, cyan or magenta	14.0 mA (typ) / 21.0 mA (max) Peak: 38 mA (switch is closed) 16.0 mA (typ) / 22.0 mA (max) Peak: 43 mA (switch is open)
Current Consumption Illumination white	19.0 mA (typ) / 25.0 mA (max) Peak: 43 mA (switch is closed)
Reverse Polarity Protection	yes
Output Type	OptoMOS Relay
Lifetime	>20 million actuations
connection type ²	TTS Bi-Color 4 Litzen, 26AWG, 0.128 mm ² TTS RGB 6 Litzen, 26AWG, 0.128 mm ²

Mechanical Data

Actuation Type	optical
Actuating Force	none
Shock Protection	IK06
Mounting Depth	16.5 mm
Tightening Torque Plastic Nut	2.5 Nm

Climatical Data

Operating Temperature	-30 to 85 °C
Storage Temperature	-40 to 85 °C
IP Protection Class Front Side	IP67 acc. to IEC 60529

Material

Housing	Stainless Steel
Illuminated Ring (Ring Illumination)	PMMA
Sensor Window	PC
Seal Ring	NBR70

¹ on request also available as NC / ² on request also available with cable or connector





Approvals and Compliances

Detailed information on product approvals, code requirements, usage instructions and detailed test conditions can be looked up in [Details about Approvals](#)

SCHURTER products are designed for use in industrial environments. They have approvals from independent testing bodies according to national and international standards. Products with specific characteristics and requirements such as required in the automotive sector according to IATF 16949, medical technology according to ISO 13485 or in the aerospace industry can be offered exclusively with customer-specific, individual agreements by SCHURTER.

Compliances

The product complies with following Guide Lines

Identification	Details	Initiator	Description
	CE declaration of conformity	SCHURTER AG	The CE marking declares that the product complies with the applicable requirements laid down in the harmonisation of Community legislation on its affixing in accordance with EU Regulation 765/2008.
	UKCA declaration of conformity	SCHURTER AG	The UKCA marking declares that the product complies with the applicable requirements laid down in the British Amendment of Regulation (EC) 765/2008.
	RoHS	SCHURTER AG	Directive RoHS 2011/65/EU, Amendment (EU) 2015/863
	REACH	SCHURTER AG	On 1 June 2007, Regulation (EC) No 1907/2006 on the Registration, Evaluation, Authorization and Restriction of Chemicals 1 (abbreviated as "REACH") entered into force.

Dimension [mm]

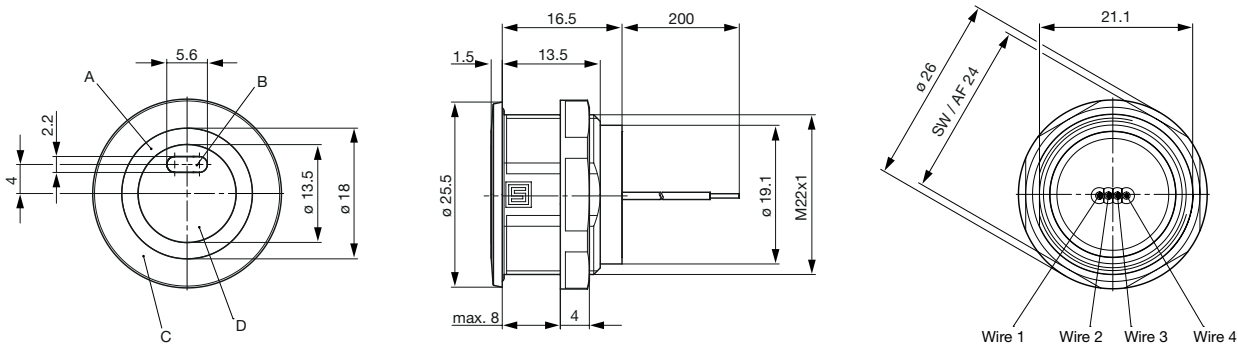

- A ring illumination
- B sensor window
- C housing
- D actuator

Dimension for RGB Variants

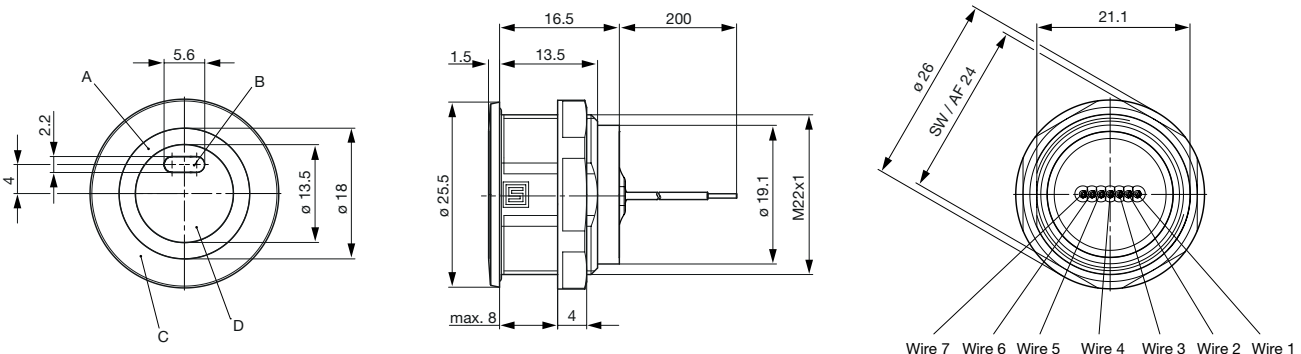

- A ring illumination
- B sensor window
- C housing
- D actuator

Dimension

Mounting hole

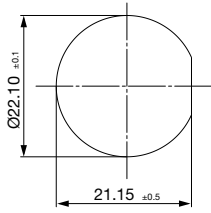

Diagrams

Connection diagram

TTS Bicolor Connection wire assignment		
Wire-number	Wire color	function
Wire 1	brown	Vin = 5 VDC...28 VDC
Wire 2	black	GND
Wire 3	white	OUT1
Wire 4	white	OUT2

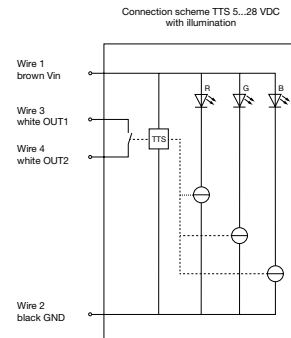



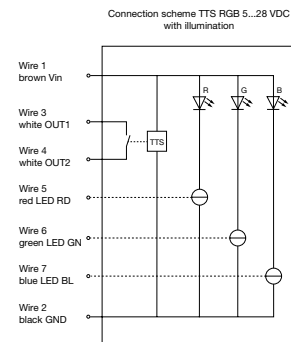

TTS RGB Connection wire assignment		
Wire-number	Wire color	function
Wire 1	brown	Vin = 5 VDC...28 VDC
Wire 2	black	GND
Wire 3	white	OUT1
Wire 4	white	OUT2
Wire 5	red	LED red
Wire 6	green	LED green
Wire 7	blue	LED blue



Lettering Colour of Laser Lettering

Material	Lettering Colour
Stainless Steel	black Filled letters

Order Index Lettering

Laser Marking			
001 =A	021 =U	041 =÷	061 =EIN
002 =B	022 =V	042 = *	062 =AUS
003 =C	023 =W	043 ==	063 =AUF
004 =D	024 =X	044 = #	064 =AB
005 =E	025 =Y	045 = ↔	065 =ON
006 =F	026 =Z	046 = †	066 =OFF
007 =G	027 =0	047 = →	067 =UP
008 =H	028 =1	048 = ←	068 =DOWN
009 =I	029 =2	049 = ↓	069 =HIGH
010 =J	030 =3	050 = ↑	070 =LOW
011 =K	031 =4	051 = %	071 =ON/OFF
012 =L	032 =5	052 = √	072 =START
013 =M	033 =6	053 =CTRL	073 =RESET
014 =N	034 =7	054 =RETURN	074 = 
015 =O	035 =8	055 =SHIFT	075 = 
016 =P	036 =9	056 =LOCK	076 = 
017 =Q	037 =+	057 =STOP	077 = 
018 =R	038 =-	058 =ENTER	
019 =S	039 =.	059 =BACK	
020 =T	040 =x	060 =LINE	

Please note that the font size depends on the number of characters

Order number key

T	T	S	-	22	-	LA	NO	A10	F0	-	RI	ORG	VAR	F0	-	SO	NC	-	B	-	06	-	SO	NC	NF	-	0	000	-	C
				1		2	3	4	5		6	7	8	9		10	11		12		13		14	15	16		17	18		19

Diameter  **1**
 22 mm = 22

Switch type  **2**
 Latching = LA
 Momentary = MO

Switch function  **3**
 Normally open = NO

Rated current  **4**
 100mA = A10

Terminal switch  **5**
 Flexible wires = F0

Illumination / appearance  **6**
 Ring illumination = RI

Illumination / appearance color  **7**
 Red-green = ORG
 RGB = RGB

Supply voltage illumination  **8**
 5-28V = VAR

Terminal illumination  **9**
 Flexible wires = F0

Housing material  **10**
 Stainless = S0

Housing color  **11**
 Natural = NC

Mounting  **12**
 Thread (M) W/ anti-rotation protection = B

Detection distance *  **13**
 6 cm = 06

Actuator material  **14**
 Stainless steel = S0

Actuator color  **15**
 Natural = NC

Actuator style  **16**
 No Finger guided = NF

Lettering type  **17**
 None = 0

Marking type  **18**
 None = 000

Accessories  **19**
 Hex nut plastic w / O-Ring = C

* Distance can be changed at the production site. MOQ > 100 pcs.

All Variants

Diameter [mm]	Illumination	Illumination Color inactive / active	Function	Accessories	Order Number
22	Ring Illumination	multicolor	latching (LA)	Hex nut plastic	3-135-364
22	Ring Illumination	multicolor	momentary (MO)	Hex nut plastic	3-135-363
22	Ring Illumination	bi-colored green / red	latching (LA)	Hex nut plastic	3-131-913
22	Ring Illumination	bi-colored green / red	momentary (MO)	Hex nut plastic	3-131-894

Latching and momentary NO switch are open after power-up (protection against unintended switching)

Availability for all products can be searched real-time: <https://www.schurter.com/en/Stock-Check/Stock-Check-SCHURTER>

Minimum order quantity for standard variants with or without laser marking is 10 pieces.

Packaging unit	10 Pcs
-----------------------	--------