









# DATASHEET

MG10

v1.2

# 1. Datasheet

## 1.1. MG10

General Properties		Minimum	Typical	Maximum	Unit
Payload *	No pads parallel to the ground 	0.001 0.002	- -	10 22.046	[kg] [lb]
	No pads perpendicular to the ground 	0.001 0.002		3.4 7.49	[kg] [lb]
	Protective pads 	0.001 0.002		2.8 6.17	[kg] [lb]
	Protective pads vertical 	0.001 0.002		2.65 5.84	[kg] [lb]
	Cylindrical workpieces parallel to the ground 	0.001 0.002		4.1 9.038	[kg] [lb]
	Cylindrical workpieces perpendicular to the ground x 	0.001 0.002		3 6.61	[kg] [lb]
	Cylindrical workpieces perpendicular to the ground y 	0.001 0.002		2.2 4.85	[kg] [lb]
Pulling force				300	[N]
Workpiece size required for full force [L,W] **		65.4 x 65.4 2.574 x 2.574	- -	- -	[mm] [inch]
Magnetism resolution		-	10	-	[steps]
Gripping time (including brake activation)		-	300 ***	-	[ms]
Hold workpiece if power is lost?		Yes			
Storage temperature		0 32	- -	55 131	[°C] [°F]
Motor		Integrated, electric BLDC			

General Properties	Minimum	Typical	Maximum	Unit
IP Classification	IP67			
Dimensions [Ø, L]	71 x 80.2 2.8 x 3.24			[mm] [inch]
Weight	0.8 1.763			[kg] [lb]

\* Values are applicable at 3G. Depending on the acceleration, the gripper might be able to lift and carry up to 15 kg.

\*\* To achieve the full force, all four fingers must be in contact with the workpiece.

\*\*\* When you use the UR CB3 tool connector, the gripping time can increase up to 500 ms.

Operating Conditions	Minimum	Typical	Maximum	Unit
Power Supply	20	24	25	[V]
Operating current consumption	600 *	-	2000 **	[mA]
Operating temperature	5 41	- -	50 122	[°C] [°F]
Relative humidity (non-condensing)	0	-	95	[%]
Calculated operation life	30 000	-	-	[Hours]

\* To perform a grip.

\*\* Automatically adapts to the current requirements when UR CB3 tool connector is used (600 mA).

### Magnet Strength

The following graph shows how much payload the gripper would be able to carry around by using the fingers without pads, considering an acceleration of 3g and a workpiece of pure steel without any surface treatment.

#### Strength vs payload graph

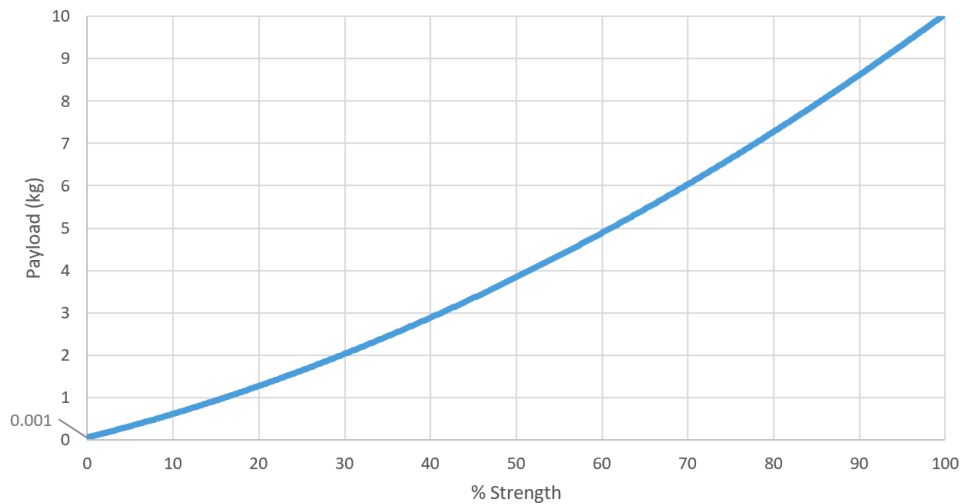

The strength that the gripper can pull with is impacted by the orientation and the different properties of the gripper's fingers and the workpiece such as material type, thickness, weight, geometry, surface finish, and so on.

In certain cases, the maximum payload values (shown on the [Strength vs payload](#) graph) might decrease down to the following values:

- Delivered Protective pads: 30% of the maximum
- Cylindrical workpieces: 41% of the maximum
- Gripping workpieces perpendicular to the ground: 28% of the maximum

For example, the suggested maximum payload of a pure steel workpiece picked with the fingers without pads is 10 kg and the same type of workpiece picked with the fingers with the delivered Protective pads will be 3 kg.

The following graph shows how the thickness of the workpiece might affect the maximum payload of the workpiece that the gripper can pick and hold if a maximum of 3G acceleration is used.

### Payload vs thickness graph

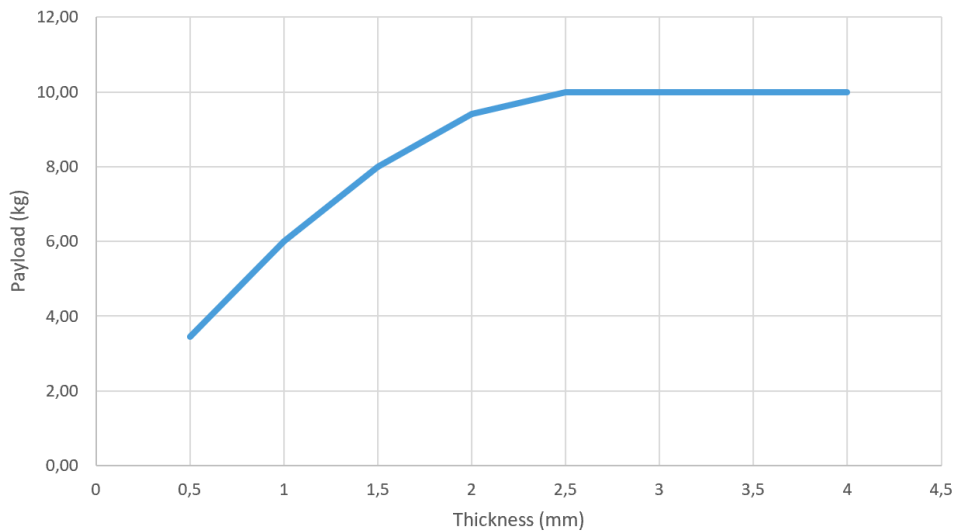

The following graph shows how the Air Gap distance affects the maximum payload of the workpiece that the gripper can pick and hold if a maximum of 3G acceleration is used.

### Payload vs Air Gap graph

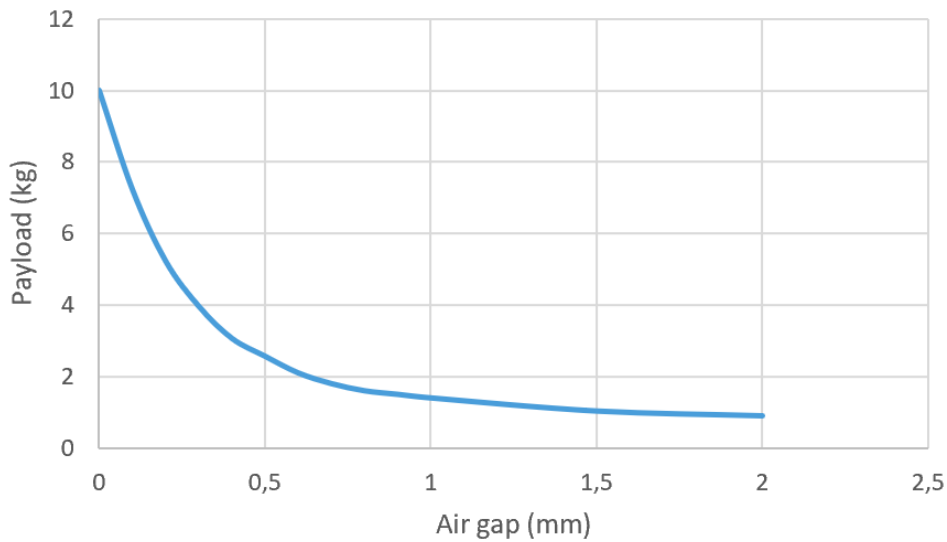

The material of the workpiece can affect the magnetism as follows:

- Iron, cobalt, and nickel are considered to be magnetic.
- Materials consisting of iron, cobalt, or nickel can still be magnetic. The magnetism of the material can be changed with the amount of the iron, cobalt, or nickel and subsequent treatments such as annealing (heat treatment).
- Surface treatments such as zinc or plastic wraps does not affect the magnetism. Any distance that the surface treatment adds between the part and the gripper will drastically decrease the force.

It is recommended to grip with 100% magnet strength when the robot will be moved at high speed and high acceleration.



#### NOTE:

Gripping with two of the four pads will result in a lower force.

### Proximity Sensor

The MG10 has a proximity sensor on the bottom part as shown in the following image.

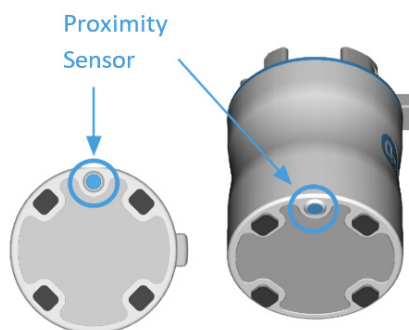

The sensor can locate workpieces within 2 mm distance.

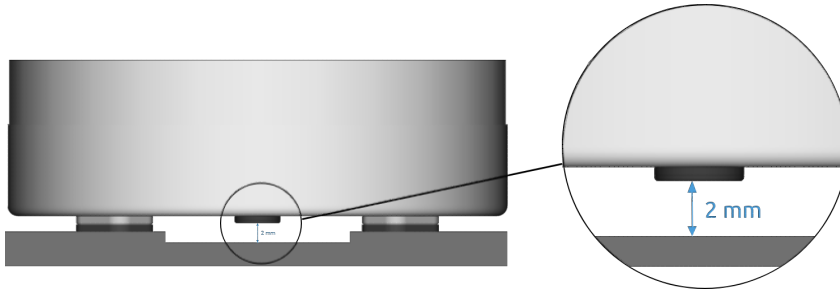

## Smart Grip and Grip Detection

Use the Smart Grip feature as follows:

- Use the gripper without fingers or with the delivered pads.
- Grip with four fingers.



### NOTE:

The Smart grip feature cannot be used together with the Eyes Location application.

The Grip detection feature works as long as you use the following finger for gripping.

Finger used for  
Grip detection

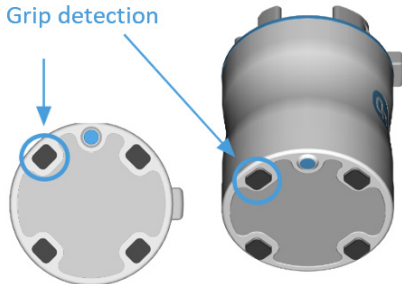

## Fingers

Pads and fingertips for cylindrical objects are delivered with the gripper to cover a wider range of applications.

### Pads

Use the protective pads when the gripper should not leave any mark on the workpiece. The protective pads are made of nylon.



### Fingertips for cylindrical objects

Use the fingertips for cylindrical objects to handle cylindrical and spherical workpieces with a diameter within 20–65 mm.



#### NOTE:

The proximity sensor will not be able to detect workpieces when the fingertips for cylindrical objects are used because the offset is higher than 2 mm in this case.

The Grip detection feature works as long as the magnet strength is set higher than 25% and you use the following finger for gripping.

Finger used for  
Grip detection

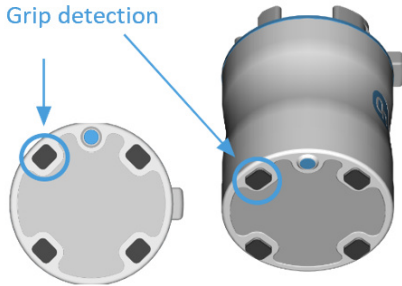

### Customized fingers

Customized fingers can be created based on the following dimensions:



#### NOTE:

Customized fingers affect the force achieved with the gripper. The force will probably be lower in this case. This pulling force decreases as shown in the [Strength vs payload](#) graph.

The proximity sensor will not be able to detect workpieces if the total offset is higher than 2 mm.

Do not create custom fingers that short-circuit two fingers that are next to each other since that will annulate the magnet strength.

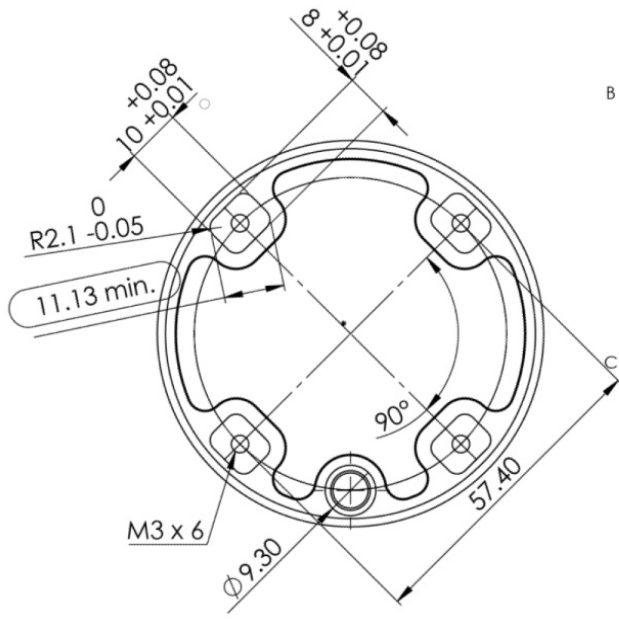

It might be beneficial to use materials that add friction such as tape, rubber, and other materials that add friction without increasing much the offset.



## 1.2. MG10

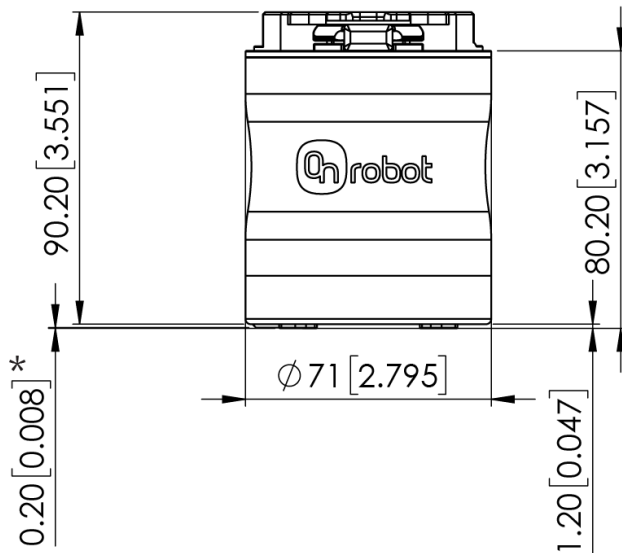
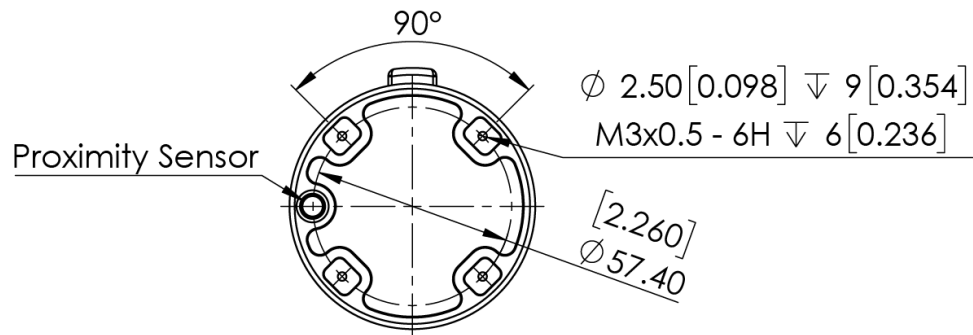

\* Distance from the proximity sensor to the fingers.

All dimensions are in mm and [inches].