

SLING Series

SLENDER WALLPACK

tradeSELECT®

FEATURES

- Two sizes for a variety of applications
- Ranges from 21W to 80W with up to 8000 lumens
- SG1 Series replaces from 100W-150W HID; SG2 Series replaces from 150W-250W HID
- Comfort lens available as an option or accessory provides glare control and enhanced uniformity
- Knuckle and trunnion accessory mounting kits available for flood applications
- IP65 and certified to UL 1598 for use in wet locations up to 40°C ambient



SPECIFICATIONS

HOUSING

- Rugged die-cast aluminum housing with corrosion resistant powder coat finish
- Heating dissipating fins provide superior thermal performance extending the life of the electronic components
- Impact resistant tempered glass offers zero uplight
- Comfort lens available as an option or accessory to reduce glare (7-10% lumen reduction) and provide better uniformity

OPTICS

- 3000K, 4000K and 5000K CCT nominal with 70 CRI
- Smaller SG1 housing has 2 LEDs, larger SG2 housing has 3 LEDs

INSTALLATION

- Side hinge allows for easy installation and wiring
- Side movement avoids damage to the lens and helps prevent injury common in drop down hinge designs
- Mounts to 4" junction box and includes a gasket to help seal electrical connections
- Four 1/2" threaded conduits hubs for surface conduit provided

ELECTRICAL

- 120-277V, 50/60Hz electronic drivers
- 347V and 480V available in large SG2 housing
- 10KA surge protection included

OPTIONS/CONTROLS

- Button photocontrol for dusk to dawn energy savings. Stock versions include 120V-277V PC with a cover which provides a choice to engage photocontrol or not. PC is installed in top hub
- Occupancy sensor available for on/off and dimming control in larger SG2 housing
- Battery backup options available in larger SG2 housing rated for either 0° C or -30° C. Performance exceeds NEC requirement providing 1 fc minimum over 10'x10' at 11' mounting height

CERTIFICATIONS

- Listed to UL1598 for use in wet location, listed for -40°C to 40°C applications
- Complies with IDA standards with zero uplight for 3000K and warmer CCT's
- IP65

WARRANTY

- 5 year warranty

KEY DATA	
Lumen Range	2263-8079
Wattage Range	21-80
Efficacy Range (LPW)	101-113
Weights lbs. (kg)	4.3-11 (2.0-5.0)

SLING SERIES

SLENDER WALLPACK

DATE:	LOCATION:
TYPE:	PROJECT:
CATALOG #:	

ORDERING GUIDE

Example: SG1-20-3K7-FT-UNV-DBT-PCU-CS

CATALOG #

ORDERING INFORMATION

Housing	CCT/CRI	Distribution	Voltage	Color/Finish	Control Options	Options
SG1-10 Size 1,10W	3K7 3000K, 70 CRI	FT Fwd Throw	UNV 120V-277V	BLT Black Matte Textured	PCU Universal Button Photocontrol (120-277V)	CS Comfort Lens
SG1-20 Size 1,20W	4K7 4000K, 70 CRI		120 120V	BLS Black Gloss Smooth	SCP ^{1,2,3} Occupancy Sensor Programmable (Dim)	E ^{1,2} Battery 0°C
SG1-30 Size 1,30W	5K7 5000K, 70 CRI		277 277V	DBT Dark Bronze Matte Textured	Specify MTG HT for OCC Sensor	EH ^{1,2} Battery w/ heater -20°
SG1-40 Size 1,40W			UHV 347V-480V	DBS Dark Brone Gloss Smooth	8F Up to 8'	
SG2-50 Size 2,50W				GTT Graphite Matte Textured	20F Up to 20'	
SG2-80 Size 2,80W				LGS Light Grey Gloss Smooth		
				PSS Platinum Silver Smooth		
				WHT White Matte Textured		
				WHS White Gloss Smooth		
				VGT Verde Green Textured		
				Color Option		
				CC Custom Color		

Notes:

- 1 Available in SG2 only, UHV available in SG2-50 only
- 2 Sensor controls & battery backup can not be used with flood accessory or kit or for inverted/up mounting, 120-227V only for SCO/SCP, 120 or 277 only for SWP, SWPM, E & EH
- 3 Must order minimum of one remote control to program dimming settings, 0-10V fully adjustable dimming with automatic daylight calibration and different time delay settings, 120-277V only

STOCK ORDERING INFORMATION

Catalog Number	CCT/CRI	Wattage	Mounting Height	Color	Color	Delivered Lumens	LPW	Weight lbs. (kg)
SG1-10-PCU	5000K/70	11W	8-12ft	120-277V	Dark Bronze	1349	122	4.3 (2.0)
SG1-10-4K-PCU	4000K/70	11W	8-12ft	120-277V	Dark Bronze	1424	129	4.3 (2.0)
SG1-20-PCU	5000K/70	21W	8-12ft	120-277V	Dark Bronze	2263	108	4.3 (2.0)
SG1-20-4K-PCU	4000K/70	21W	8-12ft	120-277V	Dark Bronze	2310	110	4.3 (2.0)
SG1-30-PCU	5000K/70	29W	10-15ft	120-277V	Dark Bronze	3270	113	4.3 (2.0)
SG1-30-4K-PCU	4000K/70	29W	10-15ft	120-277V	Dark Bronze	3060	105	4.3 (2.0)
SG1-40-PCU	5000K/70	38W	10-15ft	120-277V	Dark Bronze	4008	105	4.3 (2.0)
SG1-40-4K-PCU	4000K/70	38W	10-15ft	120-277V	Dark Bronze	4070	106	4.3 (2.0)
SG2-50-PCU	5000K/70	51W	12-18ft	120-277V	Dark Bronze	5548	110	11 (5.0)
SG2-50-4K-PCU	4000K/70	51W	12-18ft	120-277V	Dark Bronze	5526	109	11 (5.0)
SG2-80-PCU	5000K/70	80W	15-25ft	120-277V	Dark Bronze	8061	101	11 (5.0)
SG2-80-4K-PCU	4000K/70	80W	15-25ft	120-277V	Dark Bronze	8079	101	11 (5.0)

SLING SERIES

SLENDER WALLPACK

DATE:	LOCATION:
TYPE:	PROJECT:
CATALOG #:	

ORDERING GUIDE

OPTIONS AND ACCESSORIES

	Catalog Number	Description	Weight lbs. (kg)
<input type="checkbox"/>	SG1-YOKE	SG1 Series Yoke/Floodlight mount kit, includes visor	2.0 (1.0)
<input type="checkbox"/>	SG1-KNUCKLE	SG1 Series Knuckle/Floodlight mount kit, includes visor	2.0 (1.0)
<input type="checkbox"/>	SG2-YOKE	SG2 Series Yoke/Floodlight mount kit, includes visor	2.0 (1.0)
<input type="checkbox"/>	SG2-KNUCKLE	SG2 Series Knuckle/Floodlight mount kit, includes visor	2.0 (1.0)
<input type="checkbox"/>	SCP-REMOTE*	Remote control for SCP option. Order at least one per project to program and control fixtures	1 (.45)

SLING SERIES

SLENDER WALLPACK

DATE:	LOCATION:
TYPE:	PROJECT:
CATALOG #:	

PERFORMANCE DATA

Description	# of LEDs	Drive Current	System Watts	5K (5000K NOMINAL 70 CRI)					4K (4000K NOMINAL 70 CRI)					3K (3000K NOMINAL 80 CRI)				
				Lumens	LPW	B	U	G	Lumens	LPW	B	U	G	Lumens	LPW	B	U	G
SG1-10	2	140mA	11	1349	122	1	0	0	1424	129	1	0	0	1003	91	1	0	0
SG1-20	2	250mA	21	2449	115	1	0	0	2310	110	1	0	0	2054	95	1	0	0
SG1-30	2	350mA	29	3332	117	2	0	0	3060	106	1	0	0	2913	100	1	0	0
SG-40	2	450mA	38	4008	105	2	0	0	4070	106	2	0	0	3845	100	2	0	0
SG2-50-UHV	3	350mA	44	4633	106	2	0	0	4609	105	2	0	0	3895	90	2	0	0
SG2-50	3	415mA	51	5548	109	2	0	0	5526	107	2	0	0	4700	92	2	0	0
SG2-80	3	650mA	80	7851	98	2	0	1	8079	103	2	0	1	6721	86	2	0	1

*347 and 480 VAC input Lumen values are from photometric test performed in accordance with IESNA LM-79-08. Data is considered to be representative of the configurations shown. Actual performance may differ as a result of end-user environment application and inherent performance balances of the electrical components.

ELECTRICAL DATA

Catalog number	# of Drivers	Input Voltage	Current (AMPS)	System Power
SG1-10	1	120	0.09	11.0
	1	277	0.04	11.0
SG1-20	1	120	0.18	21.0
	1	277	0.08	21.0
SG1-30	1	120	0.24	28.9
	1	277	0.10	28.9
SG2-40	1	120	0.32	38.3
	1	277	0.14	38.3
SG-50-UHV	1	347	0.13	43.5
	1	480	0.18	43.5
SG2-50	1	120	0.42	50.6
	1	277	0.18	50.6
SG2-80	1	120	0.68	79.8
	1	277	0.29	79.8

PROJECTED LUMEN MAINTENANCE

Ambient Temperature	OPERATING HOURS					
	0	25,000	50,000	TM-21-11' L96 60,000	100,000	L70 (Hours)
25°C / 77°F	1.00	0.98	0.97	0.96	0.95	>791,000
40°C / 104°F	0.99	0.98	0.96	0.96	0.94	>635,000

1. Projected per IESNA TM-21-11 * (Nichia 219B, 700mA, 85°C Ts, 10,000hrs) Data references the extrapolated performance projections for the base model in a 40°C ambient, based on 10,000 hours of LED testing per IESNA LM-80-08

SLING SERIES

SLENDER WALLPACK

LUMINAIRE AMBIENT TEMPERATURE FACTOR (LATF)

Ambient Temperature		Lumen Multiplier
0° C	32° F	1.02
10° C	50° F	1.01
20° C	68° F	1.00
25° C	77° F	1.00
30° C	86° F	1.00
40° C	104° F	0.99
50° C	122° F	0.96

Use these factors to determine relative lumen output for average ambient temperatures from 0-40°C (32-104°F).

DIMENSIONS

SG1

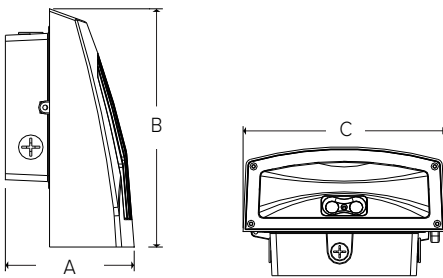

A	B	C	Weight
4.19" (107mm)	7.80" (198mm)	6.61" (168mm)	4.4lbs (2kg)

SG2

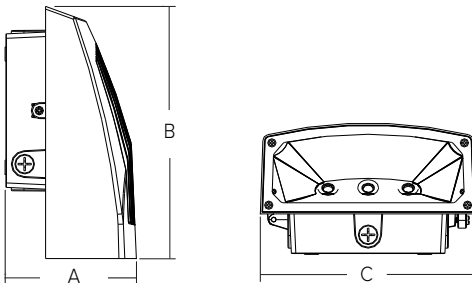

A	B	C	Weight
5.80" (147mm)	11.14" (283mm)	9.52" (242mm)	11lbs (5kg)

SG2 with occupancy sensor and battery options

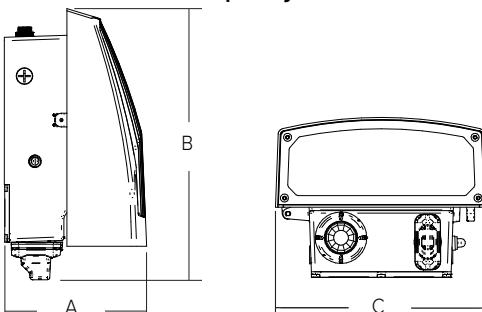

A	B	C	Weight
7.26" (184mm)	13.64" (342mm)	9.52" (242mm)	11lbs (5kg)

SLING SERIES
SLENDER WALLPACK

PHOTOMETRY

SG1-10-4K7

LUMINAIRE DATA

Description	4000 Kelvin, 70 CRI
Distribution Type	Forward Throw
Delivered Lumens	1424
Watts	11.4
Efficacy	125
Mounting	Wall

ZONAL LUMEN SUMMARY

Zone	Lumens	% Luminaire
Downward Street Side	996.6	70.0
Downward House Side	427.8	30.0
Downward Total	1424.4	100.0
Upward Street Side	0.0	0.0
Upward House Side	0.0	0.0
Upward Total	0.0	0.0
Total Flux	1424.4	100.0

ISOMETRIC FOOTCANDLE

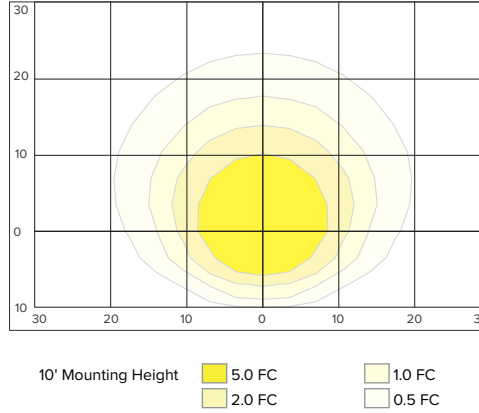

SG1-20-4K7

LUMINAIRE DATA

Description	4000 Kelvin, 70 CRI
Distribution Type	Forward Throw
Delivered Lumens	2310
Watts	20.9
Efficacy	111
Mounting	Wall

ZONAL LUMEN SUMMARY

Zone	Lumens	% Luminaire
Downward Street Side	1618	70.0
Downward House Side	692.1	30
Downward Total	2310	100.0
Upward Street Side	0.0	0.0
Upward House Side	0.0	0.0
Upward Total	0.0	0.0
Total Flux	2310.3	100.0

ISOMETRIC FOOTCANDLE

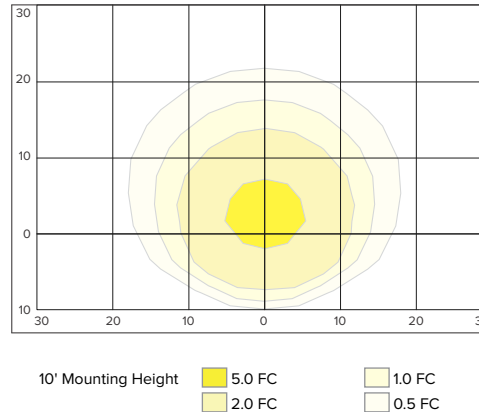

SG1-30

LUMINAIRE DATA

Description	4000 Kelvin, 70 CRI
Distribution Type	Forward Throw
Delivered Lumens	3060
Watts	29.1
Efficacy	105
Mounting	Wall

ZONAL LUMEN SUMMARY

Zone	Lumens	% Luminaire
Downward Street Side	2619.4	70.9
Downward House Side	890.4	29.1
Downward Total	3059.8	100.0
Upward Street Side	0.0	0.0
Upward House Side	0.0	0.0
Upward Total	0.0	0.0
Total Flux	3059.8	100.0

ISOMETRIC FOOTCANDLE

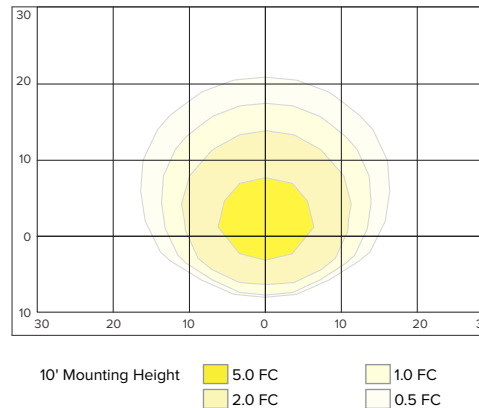

SLING SERIES

SLENDER WALLPACK

PHOTOMETRY

SG1-40-4K7

LUMINAIRE DATA

Description	4000 Kelvin, 70 CRI
Distribution Type	Forward Throw
Delivered Lumens	4070
Watts	38.1
Efficacy	107
Mounting	Wall

ZONAL LUMEN SUMMARY

Zone	Lumens	% Luminaire
Downward Street Side	2857.7	70.2
Downward House Side	1215.5	29.8
Downward Total	4070.2	100.0
Upward Street Side	0.0	0.0
Upward House Side	0.0	0.0
Upward Total	0.0	0.0
Total Flux	4070.2	100.0

ISOMETRIC FOOTCANDLE

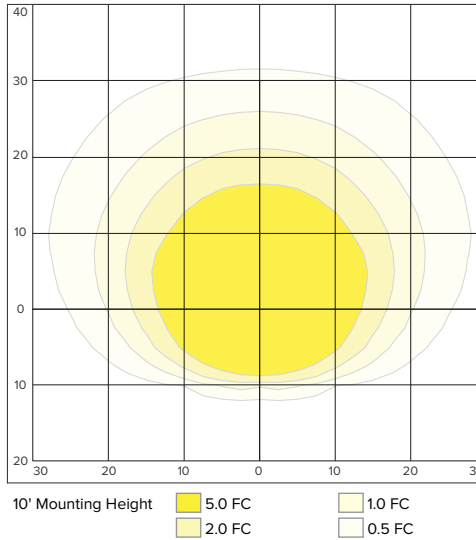

SG2-50-4K7

LUMINAIRE DATA

Description	4000 Kelvin, 70 CRI
Distribution Type	Forward Throw
Delivered Lumens	5525.7
Watts	51.7
Efficacy	107
Mounting	Wall

ZONAL LUMEN SUMMARY

Zone	Lumens	% Luminaire
Downward Street Side	4611.8	83.5
Downward House Side	913.9	16.5
Downward Total	5525.7	100.0
Upward Street Side	0.0	0.0
Upward House Side	0.0	0.0
Upward Total	0.0	0.0
Total Flux	5525.7	100.0

ISOMETRIC FOOTCANDLE

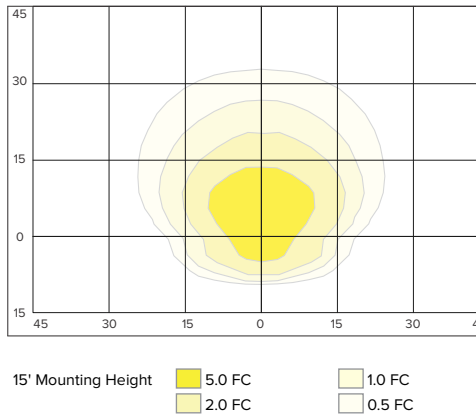

SG2-80-4K7

LUMINAIRE DATA

Description	4000 Kelvin, 70 CRI
Distribution Type	Forward Throw
Delivered Lumens	8453
Watts	78.5
Efficacy	108
Mounting	Wall

ZONAL LUMEN SUMMARY

Zone	Lumens	% Luminaire
Downward Street Side	6677.7	79.0
Downward House Side	1775.5	21.0
Downward Total	8453.2	100.0
Upward Street Side	0.0	0.0
Upward House Side	0.0	0.0
Upward Total	0.0	0.0
Total Flux	8453.2	100.0

ISOMETRIC FOOTCANDLE

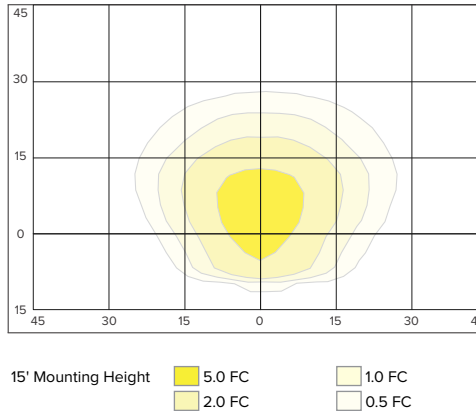

SLING SERIES
SLENDER WALLPACK

DATE: _____ LOCATION: _____

TYPE: _____ PROJECT: _____



CATALOG #: _____

ADDITIONAL INFORMATION

Shipping Information

Catalog Number	G.W(kg)/ CTN	Carton Dimensions			Carton Qty. per Master Pack	Pallet Qty.
		Length Inch (cm)	Width Inch (cm)	Height Inch (cm)		
SG1	4.35lbs (2kg)	9.5 (24)	8.25 (21)	5.25 (13)	6	98
SG2	11lbs (5kg)	14 (36)	11.5 (29)	8 (20)	2	64

Accessories and Services

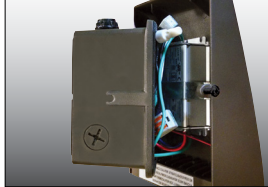
Visor	Mounting Options	Photocontrol	Hinged Housing Door
			
Visor accessory included with mounting accessory kits	Flood mounting accessories - 1/2" threaded knuckle or yoke (includes grommet and 3' SO cord)	Photocontrol option available for energy-saving dusk-to-dawn operation	Side hinged for easy installation and wiring access, single screw secures housing closure