

**M12 male 0° A-cod. with cable**

TPE 5x18AWG ye UL/CSA. ITC/PLTC 5m

Cable is approved for 600 V

Male straight

M12, 5-pole

USA

Cable is approved for 600 V

Plastic housings with good resistance against chemicals and oils.

The resistance to aggressive media should be individually tested for your application. Further details on request.

Further cable lengths on request.

**Link to Product**

**Illustration**

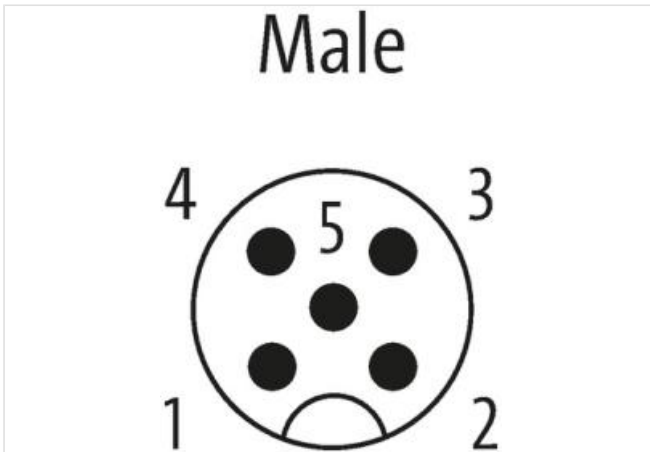
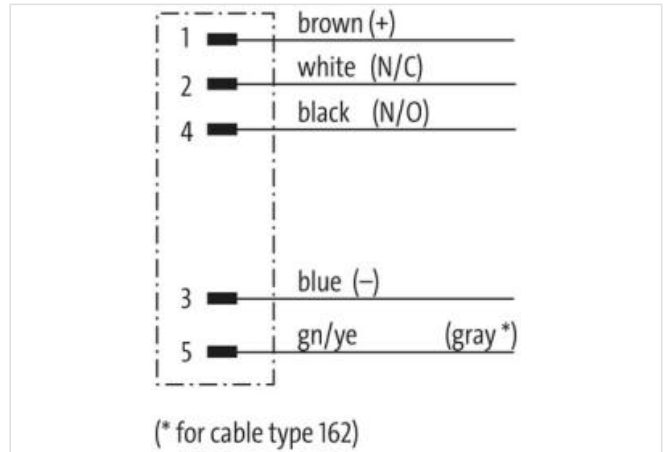

Product may differ from Image

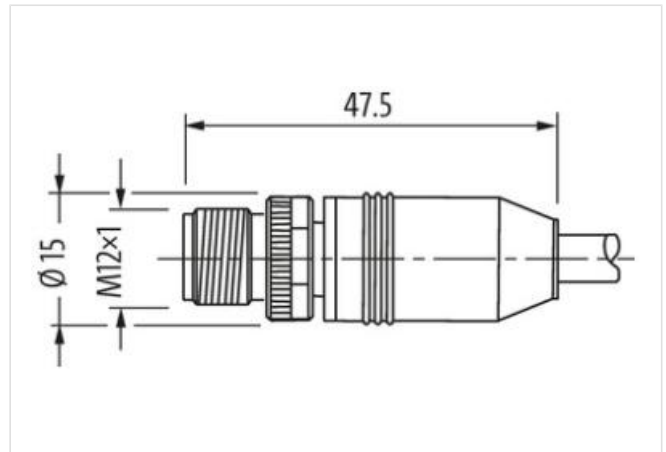

**Form**

Form

12041

Technical Data	
Operating voltage	max. 125 V AC/DC
Operating voltage (only UL listed)	30 V AC/DC
Rated surge voltage	1.5 kV
Operating current per contact	max. 4 A
Coding	A-coded
Locking of ports	Screw thread (M12×1 mm) recommended torque 0.6 Nm, self-securing
Protection	IP65, IP66K, IP67 inserted and tightened (EN 60529)
Material	PUR
Locking material	Zinc die casting, matte nickel plated
Compression gland	M12 (SW13)
General data	
Temperature range	-25...+85 °C, depending on cable quality
Cables	
Cable identification	161
Cable Type	TPE
Approval (cable)	UL (AWM-Style 20626/10708), CSA; CE conform
Cable weight [g/m]	92,49 g
Material (wire)	Cu wire, bare
Resistor (core)	max. 22.5 Ω/km (20 °C)
Single wire Ø (core)	0.234 mm
Construction (core)	19× 0.254 mm (multi-strand wire class 5)
Diameter (core)	5× AWG18/19
Material (wire isolation)	PVC
Wire-Ø incl. isolation	1.93 mm ±5%
Color/numbering of wires	br, bk, bl, wh, gnye longitudinally striped
Stranding combination	5 wires twisted around central filler
Shield	no
Material (jacket)	TPE
Outer-Ø (jacket)	7.7 mm ±5%
Color (jacket)	yellow
thermal resistance	flame retardant
Nominal voltage	600 V AC
Test voltage	4000 V
Current load capacity	to DIN VDE 0298-4
Temperature range (fixed)	-40...+105 °C
Temperature range (mobile)	-20...+90 °C
Bend radius (fixed)	10× outer Ø
Bend radius (moving)	15× outer Ø
No. of bending cycles (C-track)	max. 10 Mio. (25 °C)
Torsion stress	±180°/m
No. of torsion cycles	max. 3 Mio. (25 °C)
Product article number of manufacturer	7700-12041-1610500
Cable length	5 m