

DATE:	LOCATION:
TYPE:	PROJECT:
CATALOG #:	

LXEM

ENCLOSED AND GASKETED FIBERGLASS EXTREME ENVIRONMENT

FEATURES

- Available in 2', 4', or 8' lengths
- IP65, IP67 and IP66 all models with standard polyacetal (POM) latches
- NEMA 4X housing
- Fiberglass housing with F1 weatherability rating, standard
- IK10 rated when ordered with polycarbonate lens
- Impact modified acrylic lens equivalent to 100% DR
- UL Sanitation Certified per NSF Standards
- Includes stainless steel surface mounting brackets
- -20°C up to +50°C ambient operation; see table provided for details



RELATED PRODUCTS

- [LXEN](#)
- [LXEP](#)
- [LXEW](#)

SPECIFICATIONS

CONSTRUCTION

- Housing is formed from UL 5VA fiberglass
- F1 weatherability rating, suitable for indoor or outdoor use with respect to exposure to UV light
- Pour-in-place non-porous gasketing assures seal
- LED affixed to removable heat sinked gear tray
- 14 Latches per 8'; 8 per 4'; 6 per 2'
- Latches are provided tamper resistance ready, tamper resistant screws by others
- Latches are standard polyacetal (POM), optional in stainless steel
- Access openings are provided for electrical connection
- White painted parts are treated with a five-stage phosphate bonding process and finished with high reflectance baked enamel

OPTICS

- Lineal ribbed frosted acrylic lens impact modified equivalent to 100% DR; modification adds flexibility to reduce impact breakage compared to standard acrylic formulations
- Optional ribbed polycarbonate lens or deep acrylic
- All lenses available in clear or frost

ELECTRICAL

- Long life 60,000 hour LEDs at L80 for reduced maintenance
- Extra High Lumen packages (XL) rated L70 at 60,000 hours
- 80 CRI
- Driver options include fixed output for on/off function, step dimming (high/low/off) or continuous 0-10V dimming
- QR code label affixed to housing for easy traceability

CERTIFICATIONS

- All luminaires are built to UL 1598 and 2108 standards, and bear appropriate cCSAus labels
- CSA certified to UL 924 standards with battery pack or DTS (Dimming Bypass Module) options
- Wet Location label standard
- UL Sanitation certified to NSF standards
- Ingress protection IP65 and IP67 standard; IP66 on certain models

CERTIFICATIONS (CONTINUED)

- DLC® (DesignLights Consortium) Qualified, with some Premium Qualified configurations. Please refer to the DLC website for specific product qualifications at www.designlights.org
- The DTS, Dimming Bypass Module, is for emergency circuit control loads including sensors and wireless systems CSA certified to UL 924. See page 10 for wiring diagram. [Link to Dimming Bypass Module Specification sheet](#)
- This product qualifies as a “designated country construction material” per FAR 52.225-11 Buy American-Construction Materials under Trade Agreements effective 06/01/2020. [See Buy American Solutions](#)

WARRANTY

- 5 year warranty
- See [HLI Standard Warranty](#) for additional information

KEY DATA	
Lumen Range	2145–22,473
Wattage Range	20-183
Efficacy Range (LPW)	99-147
Reported Life (Hours)	L80/60,000

ORDERING GUIDE

Example: LXEM4-35HL-RFA-EDU

CATALOG # _____

LXEM		Color Temp			Nominal Lumens			Shielding		Driver		Voltage	
Model	Size												
LXEM	2 2' ^{1,2,3,4}	30	3000K	VW	2' (2,145-2,708)	HL	2' (4,254-5,416)	RFA	Ribbed Frosted Acrylic	E	Fixed Output	U	120-277V
LED Enclosed and Gasketed	4 4'	35	3500K		4' (2,802-3,433)		4' (5,449-6,763)	RA	Ribbed Clear Acrylic ⁵	ED	0-10V Dimming	347	347V
	8 8'	40	4000K	LW	2' (2,738-3,529)	VL	4' (7,086-8,415)	DFA	Deep Frosted Acrylic	ED1	0-10V 1% Dimming ⁷		
		50	5000K		4' (3,726-4,922)		8' (14,747-16,830)	DCA	Deep Clear Acrylic ⁵	ESD	Step Dimming ⁷		
				ML	2' (3,862-4,921)	XL	4' (9,059-11,237)	RFP	Ribbed Frosted Polycarbonate ⁶				
					4' (4,533-5,646)		8' (19,558-22,473)	RP	Ribbed Clear Polycarbonate ^{5,6}				
					8' (9,844-11,293)								

Options	
ELL14	Emergency Battery Pack Installed, 1400 Lumens ^{3,7,8}
GLR	Fast Blow Fuse
DTS	Dimming Bypass Module ^{3,8,9}
OCM	Microwave Occupancy Sensor ^{8,13}
SSL	Stainless Steel Tamper Resistance Ready Latches
TP	Tamper Proof Latches
F3C8W	3-Wire 8' Wet Cord
F3C15W	3-Wire 15' Wet Cord
F4C8W	4-Wire 8' Wet Cord
F4C15W	4-Wire 15' Wet Cord
F5C8W	5-Wire 8' Wet Cord
F5C15W	5-Wire 15' Wet Cord
F6C6W	6-Wire 6' Wet Cord
SWH	Single Wet Hub 1/2" NPT Hub
DWH	Dual Wet Hub 1/2" NPT Hub
ZRE	ControlScope® compatible ^{8,10}

Accessories	
<input type="checkbox"/> XEDPM	Dual Pendant Brackets (pendant by others) ¹¹
<input type="checkbox"/> XEHC	Chain Hanger Kit (Includes 14" Chain)
<input type="checkbox"/> XE45MB	45° Mounting Bracket ¹²
<input type="checkbox"/> XE45MBSS	45° Stainless Steel Mounting Bracket ¹²

Sensor kits (Order Separately)					
All sensor kits include On/Off Occupancy & Daylight.					
Daylight activation requires setting of dip-switches on site.					
	Catalog #	# Relays	Lens Type	Voltage	Wet Label
120V/277V	<input type="checkbox"/> OS1360WLK	1	360°	120/277	Yes
	<input type="checkbox"/> OS2360WLK	2	360°	120/277	Yes
	<input type="checkbox"/> OS1AWLK	1	Aisle	120/277	Yes
	<input type="checkbox"/> OS2AWLK	2	Aisle	120/277	Yes

- Notes:
- 1 VL and XL not available in 2' size
 - 2 Not available with battery pack or DTS
 - 3 Not available with XL lumen package
 - 4 Not available with VL lumen package
 - 5 Clear lenses (RA, DCA and RP) may cause noticeable light patterns on lit surfaces. See ies files for exact distribution
 - 6 2' and 4' only. 8' not available
 - 7 See table for availability
 - 8 Not available in 347V
 - 9 For emergency circuit control loads including sensors and wireless systems listed to UL924. Only available with 0-10V drivers. See page 10 for wiring diagram
 - 10 Registered trademark of Daintree Networks, used by permission
 - 11 Requires 3/8" OD threaded rod by others
 - 12 2 required for 8' fixture
 - 13 OCM option uses Wattstopper FM-105

PRODUCT EXCEPTIONS & DETAILS

Options listed below are available for the outputs as shown.

DRIVER AVAILABILITY TABLE							
Length	Output	Nominal Lumen Range	ESD Available	ED1 Available	347V Available	347V with ESD Available	347V with ED1 Available
2'	VW	2,145–2,708	Y	Y	Y	N/A	Y
	LW	2,738–3,529	Y	Y	Y	N/A	Y
	ML	3,862–4,921	Y	Y	Y	N/A	Y
	HL	4,254–5,416	Y	Y	Y	N/A	Y
4'	VW	2,802–3,433	Y	Y	Y	N/A	Y
	LW	3,726–4,922	Y	Y	Y	N/A	Y
	ML	4,533–5,646	Y	Y	Y	N/A	Y
	HL	5,449–6,763	Y	Y	Y	N/A	Y
	VL	7,086–8,415	Y	Y	Y	N/A	N/A
	XL	9,059–11,237	N/A	Y	Y	N/A	N/A
8'	VW	6,078–6,866	Y	Y	Y	N/A	Y
	LW	8,095–9,276	Y	Y	Y	N/A	Y
	ML	9,844–11,293	Y	Y	Y	N/A	Y
	HL	11,851–13,525	Y	Y	Y	N/A	Y
	VL	14,747–16,830	Y	Y	Y	N/A	N/A
	XL	19,558–22,473	N/A	Y	Y	N/A	N/A

MAX. AMBIENT OPERATING TEMP.							
Length	Output	Nominal Lumen Range	Watts	LPW	Max Ambient Operating Temperature (C°) (Universal Voltage)	ELL14 (with Universal Voltage)	347V
2'	VW	2,145–2,708	21	102–130	40	NA	35
	LW	2,738–3,529	26	105–135	40	NA	35
	ML	3,862–4,921	39	100–128	40	NA	35
	HL	4,254–5,416	44	97–123	35	NA	30
4'	VW	2,802–3,433	25	114–141	50	45	45
	LW	3,726–4,922	33	112–139	50	45	45
	ML	4,533–5,646	42	108–134	50	45	45
	HL	5,449–6,763	47	115–143	45	45	35
	VL	7,086–8,415	62	115–136	40	40	35
	XL	9,059–11,237	92	99–123	30	NA	25
8'	VW	6,078–6,866	49	124–141	50	45	45
	LW	8,095–9,276	67	122–139	50	45	45
	ML	9,844–11,293	84	117–134	50	45	45
	HL	11,851–13,525	95	125–143	45	45	35
	VL	14,747–16,830	123	120–136	40	40	35
	XL	19,558–22,473	183	107–123	30	NA	25

DELIVERED LUMENS

PRODUCT AVAILABILITY 80 CRI							
Lumen Package	Output	Color	Lens	Lumens	Watts	LPW	Max Ambient Operating Temp
LXEM2-30VW-RFP-EDU	Very Low Watt	30K	RFP	2,145	211	101.6	40°C
LXEM2-30VW-RA-EDU			RA	2,365	20.8	113.7	40°C
LXEM2-30VW-RP-EDU			RP	2,373	20.8	114.1	40°C
LXEM2-30VW-RFA-EDU			RFA	2,448	20.8	117.7	40°C
LXEM2-30VW-DFA-EDU			DFA	2,467	20.8	118.6	40°C
LXEM2-30VW-DCA-EDU			DCA	2,512	20.8	120.8	40°C
LXEM2-35VW-RFP-EDU		35K	RFP	2,217	211	105.1	40°C
LXEM2-35VW-RA-EDU			RA	2,446	20.8	117.6	40°C
LXEM2-35VW-RP-EDU			RP	2,454	20.8	118	40°C
LXEM2-35VW-RFA-EDU			RFA	2,531	20.8	121.7	40°C
LXEM2-35VW-DFA-EDU			DFA	2,551	20.8	122.6	40°C
LXEM2-35VW-DCA-EDU			DCA	2,598	20.8	124.9	40°C
LXEM2-40VW-RFP-EDU		40K	RFP	2,252	211	106.7	40°C
LXEM2-40VW-RA-EDU			RA	2,484	20.8	119.4	40°C
LXEM2-40VW-RP-EDU			RP	2,492	20.8	119.8	40°C
LXEM2-40VW-RFA-EDU			RFA	2,571	20.8	123.6	40°C
LXEM2-40VW-DFA-EDU			DFA	2,590	20.8	124.5	40°C
LXEM2-40VW-DCA-EDU			DCA	2,638	20.8	126.8	40°C
LXEM2-50VW-RFP-EDU		50K	RFP	2,312	211	109.6	40°C
LXEM2-50VW-RA-EDU			RA	2,550	20.8	122.6	40°C
LXEM2-50VW-RP-EDU			RP	2,558	20.8	123	40°C
LXEM2-50VW-RFA-EDU			RFA	2,639	20.8	126.9	40°C
LXEM2-50VW-DFA-EDU			DFA	2,659	20.8	127.8	40°C
LXEM2-50VW-DCA-EDU			DCA	2,708	20.8	130.2	40°C
LXEM2-30LW-RFP-EDU	Low Watt	30K	RFP	2,738	26	105.3	40°C
LXEM2-30LW-RP-EDU			RP	3,049	26.1	116.8	40°C
LXEM2-30LW-RA-EDU			RA	3,144	26	120.9	40°C
LXEM2-30LW-RFA-EDU			RFA	3,180	26.2	121.4	40°C
LXEM2-30LW-DFA-EDU			DFA	3,239	26.1	124.1	40°C
LXEM2-30LW-DCA-EDU			DCA	3,273	26.1	125.4	40°C
LXEM2-35LW-RFP-EDU		35K	RFP	2,831	26	108.9	40°C
LXEM2-35LW-RP-EDU			RP	3,153	26.1	120.8	40°C
LXEM2-35LW-RA-EDU			RA	3,251	26	125	40°C
LXEM2-35LW-RFA-EDU			RFA	3,289	26.2	125.5	40°C
LXEM2-35LW-DFA-EDU			DFA	3,349	26.1	128.3	40°C
LXEM2-35LW-DCA-EDU			DCA	3,385	26.1	129.7	40°C
LXEM2-40LW-RFP-EDU		40K	RFP	2,875	26	110.6	40°C
LXEM2-40LW-RP-EDU			RP	3,202	26.1	122.7	40°C
LXEM2-40LW-RA-EDU			RA	3,302	26	127	40°C
LXEM2-40LW-RFA-EDU			RFA	3,339	26.2	127.5	40°C
LXEM2-40LW-DFA-EDU			DFA	3,401	26.1	130.3	40°C
LXEM2-40LW-DCA-EDU			DCA	3,437	26.1	131.7	40°C
LXEM2-50LW-RFP-EDU		50K	RFP	2,951	26	113.5	40°C
LXEM2-50LW-RP-EDU			RP	3,287	26.1	125.9	40°C
LXEM2-50LW-RA-EDU			RA	3,390	26	130.4	40°C
LXEM2-50LW-RFA-EDU			RFA	3,428	26.2	130.9	40°C
LXEM2-50LW-DFA-EDU			DFA	3,492	26.1	133.8	40°C
LXEM2-50LW-DCA-EDU			DCA	3,529	26.1	135.2	40°C
LXEM2-30ML-RFP-EDU	Medium Lumen	30K	RFP	3,862	38.5	100.3	40°C
LXEM2-30ML-RP-EDU			RP	4,228	38.5	109.8	40°C
LXEM2-30ML-RFA-EDU			RFA	4,343	38.5	112.8	40°C
LXEM2-30ML-RA-EDU			RA	4,446	38.5	115.5	40°C
LXEM2-30ML-DFA-EDU			DFA	4,526	38.5	117.5	40°C
LXEM2-30ML-DCA-EDU			DCA	4,565	38.5	118.6	40°C
LXEM2-35ML-RFP-EDU		35K	RFP	3,993	38.5	103.7	40°C
LXEM2-35ML-RP-EDU			RP	4,371	38.5	113.5	40°C
LXEM2-35ML-RFA-EDU			RFA	4,490	38.5	116.6	40°C
LXEM2-35ML-RA-EDU			RA	4,597	38.5	119.4	40°C
LXEM2-35ML-DFA-EDU			DFA	4,680	38.5	121.5	40°C
LXEM2-35ML-DCA-EDU			DCA	4,720	38.5	122.6	40°C
LXEM2-40ML-RFP-EDU		40K	RFP	4,055	38.5	105.3	40°C
LXEM2-40ML-RP-EDU			RP	4,439	38.5	115.3	40°C
LXEM2-40ML-RFA-EDU			RFA	4,560	38.5	118.4	40°C
LXEM2-40ML-RA-EDU			RA	4,668	38.5	121.3	40°C
LXEM2-40ML-DFA-EDU			DFA	4,752	38.5	123.4	40°C
LXEM2-40ML-DCA-EDU			DCA	4,793	38.5	124.5	40°C
LXEM2-50ML-RFP-EDU		50K	RFP	4,163	38.5	108.1	40°C
LXEM2-50ML-RP-EDU			RP	4,558	38.5	118.4	40°C
LXEM2-50ML-RFA-EDU			RFA	4,682	38.5	121.6	40°C
LXEM2-50ML-RA-EDU			RA	4,793	38.5	124.5	40°C
LXEM2-50ML-DFA-EDU			DFA	4,879	38.5	126.7	40°C
LXEM2-50ML-DCA-EDU			DCA	4,921	38.5	127.8	40°C

DELIVERED LUMENS (CONTINUED)

PRODUCT AVAILABILITY 80 CRI								
Lumen Package	Output	Color	Lens	Lumens	Watts	LPW	Max Ambient Operating Temp	
LXEM2-30HL-RFP-EDU	High Lumen	30K	RFP	4,254	44.1	96.5	35°C	
LXEM2-30HL-RP-EDU			RP	4,700	44.1	106.6	35°C	
LXEM2-30HL-RA-EDU			RA	4,868	44.1	110.4	35°C	
LXEM2-30HL-RFA-EDU			RFA	4,874	44.1	110.5	35°C	
LXEM2-30HL-DFA-EDU			DFA	5,008	44.1	113.6	35°C	
LXEM2-30HL-DCA-EDU			DCA	5,024	44.1	113.9	35°C	
LXEM2-35HL-RFP-EDU		35K	RFP	4,399	44.1	99.7	35°C	
LXEM2-35HL-RP-EDU			RP	4,860	44.1	110.2	35°C	
LXEM2-35HL-RA-EDU			RA	5,033	44.1	114.1	35°C	
LXEM2-35HL-RFA-EDU			RFA	5,040	44.1	114.3	35°C	
LXEM2-35HL-DFA-EDU			DFA	5,179	44.1	117.4	35°C	
LXEM2-35HL-DCA-EDU			DCA	5,195	44.1	117.8	35°C	
LXEM2-40HL-RFP-EDU		40K	RFP	4,467	44.1	101.3	35°C	
LXEM2-40HL-RP-EDU			RP	4,935	44.1	111.9	35°C	
LXEM2-40HL-RA-EDU			RA	5,111	44.1	115.9	35°C	
LXEM2-40HL-RFA-EDU			RFA	5,117	44.1	116	35°C	
LXEM2-40HL-DFA-EDU			DFA	5,259	44.1	119.2	35°C	
LXEM2-40HL-DCA-EDU			DCA	5,275	44.1	119.6	35°C	
LXEM2-50HL-RFP-EDU		50K	RFP	4,586	44.1	104	35°C	
LXEM2-50HL-RP-EDU			RP	5,066	44.1	114.9	35°C	
LXEM2-50HL-RA-EDU			RA	5,248	44.1	119	35°C	
LXEM2-50HL-RFA-EDU			RFA	5,254	44.1	119.1	35°C	
LXEM2-50HL-DFA-EDU			DFA	5,399	44.1	122.4	35°C	
LXEM2-50HL-DCA-EDU			DCA	5,416	44.1	122.8	35°C	
LXEM4-30VW-RFP-EDU		Very Low Watt	30K	RFP	2,802	24.5	114.4	50°C
LXEM4-30VW-RP-EDU				RP	2,938	24.4	120.4	50°C
LXEM4-30VW-RA-EDU				RA	3,039	24.4	124.6	50°C
LXEM4-30VW-RFA-EDU				RFA	3,048	24.5	124.4	50°C
LXEM4-30VW-DCA-EDU				DCA	3,180	24.4	130.3	50°C
LXEM4-30VW-DFA-EDU				DFA	3,184	24.4	130.5	50°C
LXEM4-35VW-RFP-EDU	35K		RFP	2,897	24.5	118.2	50°C	
LXEM4-35VW-RP-EDU			RP	3,038	24.4	124.5	50°C	
LXEM4-35VW-RA-EDU			RA	3,143	24.4	128.8	50°C	
LXEM4-35VW-RFA-EDU			RFA	3,151	24.5	128.6	50°C	
LXEM4-35VW-DCA-EDU			DCA	3,288	24.4	134.8	50°C	
LXEM4-35VW-DFA-EDU			DFA	3,293	24.4	134.9	50°C	
LXEM4-40VW-RFP-EDU	40K		RFP	2,942	24.5	120.1	50°C	
LXEM4-40VW-RP-EDU			RP	3,085	24.4	126.4	50°C	
LXEM4-40VW-RA-EDU			RA	3,191	24.4	130.8	50°C	
LXEM4-40VW-RFA-EDU			RFA	3,200	24.5	130.6	50°C	
LXEM4-40VW-DCA-EDU			DCA	3,339	24.4	136.8	50°C	
LXEM4-40VW-DFA-EDU			DFA	3,344	24.4	137	50°C	
LXEM4-50VW-RFP-EDU	50K		RFP	3,020	24.5	123.3	50°C	
LXEM4-50VW-RP-EDU			RP	3,168	24.4	129.8	50°C	
LXEM4-50VW-RA-EDU			RA	3,276	24.4	134.3	50°C	
LXEM4-50VW-RFA-EDU			RFA	3,285	24.5	134.1	50°C	
LXEM4-50VW-DCA-EDU			DCA	3,428	24.4	140.5	50°C	
LXEM4-50VW-DFA-EDU			DFA	3,433	24.4	140.7	50°C	
LXEM4-30LW-RFP-EDU	Low Watt		30K	RFP	3,726	33.3	111.9	50°C
LXEM4-30LW-RP-EDU				RP	3,872	33.3	116.3	50°C
LXEM4-30LW-RFA-EDU				RFA	4,048	33.3	121.5	50°C
LXEM4-30LW-RA-EDU				RA	4,054	33.3	121.8	50°C
LXEM4-30LW-DFA-EDU				DFA	4,241	33.3	127.4	50°C
LXEM4-30LW-DCA-EDU				DCA	4,303	33.3	129.2	50°C
LXEM4-35LW-RFP-EDU		35K	RFP	3,853	33.3	115.7	50°C	
LXEM4-35LW-RP-EDU			RP	4,004	33.3	120.2	50°C	
LXEM4-35LW-RFA-EDU			RFA	4,185	33.3	125.7	50°C	
LXEM4-35LW-RA-EDU			RA	4,192	33.3	125.9	50°C	
LXEM4-35LW-DFA-EDU			DFA	4,385	33.3	131.7	50°C	
LXEM4-35LW-DCA-EDU			DCA	4,449	33.3	133.6	50°C	
LXEM4-40LW-RFP-EDU		40K	RFP	3,912	33.3	117.5	50°C	
LXEM4-40LW-RP-EDU			RP	4,066	33.3	122.1	50°C	
LXEM4-40LW-RFA-EDU			RFA	4,250	33.3	127.6	50°C	
LXEM4-40LW-RA-EDU			RA	4,257	33.3	127.8	50°C	
LXEM4-40LW-DFA-EDU			DFA	4,453	33.3	133.7	50°C	
LXEM4-40LW-DCA-EDU			DCA	4,518	33.3	135.7	50°C	
LXEM4-50LW-RFP-EDU		50K	RFP	4,017	33.3	120.6	50°C	
LXEM4-50LW-RP-EDU			RP	4,174	33.3	125.3	50°C	
LXEM4-50LW-RFA-EDU			RFA	4,363	33.3	131	50°C	
LXEM4-50LW-RA-EDU			RA	4,371	33.3	131.3	50°C	
LXEM4-50LW-DFA-EDU			DFA	4,572	33.3	137.3	50°C	
LXEM4-50LW-DCA-EDU			DCA	4,638	33.3	139.3	50°C	

DELIVERED LUMENS (CONTINUED)

PRODUCT AVAILABILITY 80 CRI								
Lumen Package	Output	Color	Lens	Lumens	Watts	LPW	Max Ambient Operating Temp	
LXEM4-30ML-RFP-EDU	Medium Lumen	30K	RFP	4,533	41.9	108.2	50°C	
LXEM4-30ML-RP-EDU			RP	4,714	41.9	112.5	50°C	
LXEM4-30ML-RFA-EDU			RFA	4,922	42	117.2	50°C	
LXEM4-30ML-RA-EDU			RA	4,924	42	117.2	50°C	
LXEM4-30ML-DFA-EDU			DFA	5,160	42	122.9	50°C	
LXEM4-30ML-DCA-EDU			DCA	5,238	42	124.7	50°C	
LXEM4-35ML-RFP-EDU		35K	RFP	4,688	41.9	111.9	50°C	
LXEM4-35ML-RP-EDU			RP	4,875	41.9	116.3	50°C	
LXEM4-35ML-RFA-EDU			RFA	5,089	42	121.2	50°C	
LXEM4-35ML-RA-EDU			RA	5,091	42	121.2	50°C	
LXEM4-35ML-DFA-EDU			DFA	5,336	42	127	50°C	
LXEM4-35ML-DCA-EDU			DCA	5,416	42	128.9	50°C	
LXEM4-40ML-RFP-EDU		40K	RFP	4,760	41.9	113.6	50°C	
LXEM4-40ML-RP-EDU			RP	4,950	41.9	118.1	50°C	
LXEM4-40ML-RFA-EDU			RFA	5,168	42	123.1	50°C	
LXEM4-40ML-RA-EDU			RA	5,170	42	123.1	50°C	
LXEM4-40ML-DFA-EDU			DFA	5,418	42	129	50°C	
LXEM4-40ML-DCA-EDU			DCA	5,500	42	130.9	50°C	
LXEM4-50ML-RFP-EDU		50K	RFP	4,887	41.9	116.6	50°C	
LXEM4-50ML-RP-EDU			RP	5,082	41.9	121.3	50°C	
LXEM4-50ML-RFA-EDU			RFA	5,306	42	126.3	50°C	
LXEM4-50ML-RA-EDU			RA	5,308	42	126.4	50°C	
LXEM4-50ML-DFA-EDU			DFA	5,563	42	132.4	50°C	
LXEM4-50ML-DCA-EDU			DCA	5,646	42	134.4	50°C	
LXEM4-30HL-RFP-EDU		High Lumen	30K	RFP	5,449	47.4	115	45°C
LXEM4-30HL-RP-EDU				RP	5,648	47.2	119.7	45°C
LXEM4-30HL-RFA-EDU				RFA	5,926	47.4	125	45°C
LXEM4-30HL-RA-EDU				RA	5,932	47.3	125.4	45°C
LXEM4-30HL-DFA-EDU				DFA	6,214	47.3	131.4	45°C
LXEM4-30HL-DCA-EDU				DCA	6,273	47.4	132.4	45°C
LXEM4-35HL-RFP-EDU	35K		RFP	5,634	47.4	118.9	45°C	
LXEM4-35HL-RP-EDU			RP	5,840	47.2	123.7	45°C	
LXEM4-35HL-RFA-EDU			RFA	6,127	47.4	129.3	45°C	
LXEM4-35HL-RA-EDU			RA	6,133	47.3	129.7	45°C	
LXEM4-35HL-DFA-EDU			DFA	6,425	47.3	135.8	45°C	
LXEM4-35HL-DCA-EDU			DCA	6,487	47.4	136.9	45°C	
LXEM4-40HL-RFP-EDU	40K		RFP	5,721	47.4	120.7	45°C	
LXEM4-40HL-RP-EDU			RP	5,931	47.2	125.7	45°C	
LXEM4-40HL-RFA-EDU			RFA	6,222	47.4	131.3	45°C	
LXEM4-40HL-RA-EDU			RA	6,228	47.3	131.7	45°C	
LXEM4-40HL-DFA-EDU			DFA	6,525	47.3	137.9	45°C	
LXEM4-40HL-DCA-EDU			DCA	6,587	47.4	139	45°C	
LXEM4-50HL-RFP-EDU	50K		RFP	5,874	47.4	123.9	45°C	
LXEM4-50HL-RP-EDU			RP	6,089	47.2	129	45°C	
LXEM4-50HL-RFA-EDU			RFA	6,388	47.4	134.8	45°C	
LXEM4-50HL-RA-EDU			RA	6,394	47.3	135.2	45°C	
LXEM4-50HL-DFA-EDU			DFA	6,699	47.3	141.6	45°C	
LXEM4-50HL-DCA-EDU			DCA	6,763	47.4	142.7	45°C	
LXEM4-30VL-RP-EDU	Very High Lumen		30K	RP	7,086	61.6	115	40°C
LXEM4-30VL-RA-EDU				RA	7,373	61.7	119.5	40°C
LXEM4-30VL-RFP-EDU				RFP	7,388	61.6	119.9	40°C
LXEM4-30VL-RFA-EDU				RFA	7,395	61.6	120	40°C
LXEM4-30VL-DFA-EDU				DFA	7,756	61.7	125.7	40°C
LXEM4-30VL-DCA-EDU				DCA	7,806	61.7	126.5	40°C
LXEM4-35VL-RP-EDU		35K	RP	7,327	61.6	118.9	40°C	
LXEM4-35VL-RA-EDU			RA	7,624	61.7	123.6	40°C	
LXEM4-35VL-RFP-EDU			RFP	7,639	61.6	124	40°C	
LXEM4-35VL-RFA-EDU			RFA	7,646	61.6	124.1	40°C	
LXEM4-35VL-DFA-EDU			DFA	8,020	61.7	130	40°C	
LXEM4-35VL-DCA-EDU			DCA	8,072	61.7	130.8	40°C	
LXEM4-40VL-RP-EDU		40K	RP	7,440	61.6	120.8	40°C	
LXEM4-40VL-RA-EDU			RA	7,742	61.7	125.5	40°C	
LXEM4-40VL-RFP-EDU			RFP	7,757	61.6	125.9	40°C	
LXEM4-40VL-RFA-EDU			RFA	7,764	61.6	126	40°C	
LXEM4-40VL-DFA-EDU			DFA	8,144	61.7	132	40°C	
LXEM4-40VL-DCA-EDU			DCA	8,197	61.7	132.8	40°C	
LXEM4-50VL-RP-EDU		50K	RP	7,639	61.6	124	40°C	
LXEM4-50VL-RA-EDU			RA	7,948	61.7	128.8	40°C	
LXEM4-50VL-RFP-EDU			RFP	7,964	61.6	129.3	40°C	
LXEM4-50VL-RFA-EDU			RFA	7,971	61.6	129.4	40°C	
LXEM4-50VL-DFA-EDU			DFA	8,361	61.7	135.5	40°C	
LXEM4-50VL-DCA-EDU			DCA	8,415	61.7	136.4	40°C	

DELIVERED LUMENS (CONTINUED)

PRODUCT AVAILABILITY 80 CRI									
Lumen Package	Output	Color	Lens	Lumens	Watts	LPW	Max Ambient Operating Temp		
LXEM4-30XL-RFP-EDU	Xtra High Lumen	30K	RFP	9,059	91.3	99.2	30°C		
LXEM4-30XL-RP-EDU			RP	9,448	91.2	103.6	30°C		
LXEM4-30XL-RFA-EDU			RFA	9,779	91.2	107.2	30°C		
LXEM4-30XL-RA-EDU			RA	9,839	91.4	107.7	30°C		
LXEM4-30XL-DFA-EDU			DFA	10,358	91.4	113.3	30°C		
LXEM4-30XL-DCA-EDU			DCA	10,424	91.5	113.9	30°C		
LXEM4-35XL-RFP-EDU		35K	RFP	9,367	91.3	102.6	30°C		
LXEM4-35XL-RP-EDU			RP	9,769	91.2	107.1	30°C		
LXEM4-35XL-RFA-EDU			RFA	10,111	91.2	110.9	30°C		
LXEM4-35XL-RA-EDU			RA	10,174	91.4	111.3	30°C		
LXEM4-35XL-DFA-EDU			DFA	10,710	91.4	117.2	30°C		
LXEM4-35XL-DCA-EDU			DCA	10,778	91.5	117.8	30°C		
LXEM4-40XL-RFP-EDU		40K	RFP	9,512	91.3	104.2	30°C		
LXEM4-40XL-RP-EDU			RP	9,920	91.2	108.8	30°C		
LXEM4-40XL-RFA-EDU			RFA	10,268	91.2	112.6	30°C		
LXEM4-40XL-RA-EDU			RA	10,331	91.4	113	30°C		
LXEM4-40XL-DFA-EDU			DFA	10,876	91.4	119	30°C		
LXEM4-40XL-DCA-EDU			DCA	10,945	91.5	119.6	30°C		
LXEM4-50XL-RFP-EDU		50K	RFP	9,765	91.3	107	30°C		
LXEM4-50XL-RP-EDU			RP	10,184	91.2	111.7	30°C		
LXEM4-50XL-RFA-EDU			RFA	10,542	91.2	115.6	30°C		
LXEM4-50XL-RA-EDU			RA	10,607	91.4	116	30°C		
LXEM4-50XL-DFA-EDU			DFA	11,166	91.4	122.2	30°C		
LXEM4-50XL-DCA-EDU			DCA	11,237	91.5	122.8	30°C		
LXEM8-30VW-RA-EDU		Very Low Watt	30K	RA	6,078	48.8	124.6	50°C	
LXEM8-30VW-RFA-EDU				RFA	6,096	49	124.4	50°C	
LXEM8-30VW-DCA-EDU				DCA	6,360	48.8	130.3	50°C	
LXEM8-30VW-DFA-EDU				DFA	6,369	48.8	130.5	50°C	
LXEM8-35VW-RA-EDU				35K	RA	6,285	48.8	128.8	50°C
LXEM8-35VW-RFA-EDU					RFA	6,303	49	128.6	50°C
LXEM8-35VW-DCA-EDU	DCA		6,576		48.8	134.8	50°C		
LXEM8-35VW-DFA-EDU	DFA		6,585		48.8	134.9	50°C		
LXEM8-40VW-RA-EDU	40K		RA		6,382	48.8	130.8	50°C	
LXEM8-40VW-RFA-EDU			RFA		6,400	49	130.6	50°C	
LXEM8-40VW-DCA-EDU			DCA	6,678	48.8	136.8	50°C		
LXEM8-40VW-DFA-EDU			DFA	6,687	48.8	137	50°C		
LXEM8-50VW-RA-EDU			50K	RA	6,553	48.8	134.3	50°C	
LXEM8-50VW-RFA-EDU				RFA	6,571	49	134.1	50°C	
LXEM8-50VW-DCA-EDU	DCA			6,856	48.8	140.5	50°C		
LXEM8-50VW-DFA-EDU	DFA			6,866	48.8	140.7	50°C		
LXEM8-30LW-RFA-EDU	Low Watt			30K	RFA	8,095	66.6	121.5	50°C
LXEM8-30LW-RA-EDU					RA	8,109	66.6	121.8	50°C
LXEM8-30LW-DFA-EDU			DFA		8,482	66.6	127.4	50°C	
LXEM8-30LW-DCA-EDU			DCA		8,605	66.6	129.2	50°C	
LXEM8-35LW-RFA-EDU			35K		RFA	8,370	66.6	125.7	50°C
LXEM8-35LW-RA-EDU					RA	8,385	66.6	125.9	50°C
LXEM8-35LW-DFA-EDU				DFA	8,770	66.6	131.7	50°C	
LXEM8-35LW-DCA-EDU				DCA	8,898	66.6	133.6	50°C	
LXEM8-40LW-RFA-EDU				40K	RFA	8,500	66.6	127.6	50°C
LXEM8-40LW-RA-EDU					RA	8,514	66.6	127.8	50°C
LXEM8-40LW-DFA-EDU			DFA		8,906	66.6	133.7	50°C	
LXEM8-40LW-DCA-EDU			DCA		9,035	66.6	135.7	50°C	
LXEM8-50LW-RFA-EDU			50K		RFA	8,727	66.6	131	50°C
LXEM8-50LW-RA-EDU					RA	8,741	66.6	131.3	50°C
LXEM8-50LW-DFA-EDU		DFA		9,143	66.6	137.3	50°C		
LXEM8-50LW-DCA-EDU		DCA		9,276	66.6	139.3	50°C		
LXEM8-30ML-RFA-EDU		Medium Lumen		30K	RFA	9,844	84	117.2	50°C
LXEM8-30ML-RA-EDU					RA	9,847	84	117.2	50°C
LXEM8-30ML-DFA-EDU			DFA		10,320	84	122.9	50°C	
LXEM8-30ML-DCA-EDU			DCA		10,476	84	124.7	50°C	
LXEM8-35ML-RFA-EDU			35K		RFA	10,179	84	121.2	50°C
LXEM8-35ML-RA-EDU					RA	10,182	84	121.2	50°C
LXEM8-35ML-DFA-EDU				DFA	10,671	84	127	50°C	
LXEM8-35ML-DCA-EDU				DCA	10,832	84	128.9	50°C	
LXEM8-40ML-RFA-EDU				40K	RFA	10,336	84	123.1	50°C
LXEM8-40ML-RA-EDU					RA	10,340	84	123.1	50°C
LXEM8-40ML-DFA-EDU			DFA		10,836	84	129	50°C	
LXEM8-40ML-DCA-EDU			DCA		10,999	84	130.9	50°C	
LXEM8-50ML-RFA-EDU			50K		RFA	10,612	84	126.3	50°C
LXEM8-50ML-RA-EDU					RA	10,616	84	126.4	50°C
LXEM8-50ML-DFA-EDU	DFA			11,125	84	132.4	50°C		
LXEM8-50ML-DCA-EDU	DCA			11,293	84	134.4	50°C		

DELIVERED LUMENS (CONTINUED)

PRODUCT AVAILABILITY 80 CRI								
Lumen Package	Output	Color	Lens	Lumens	Watts	LPW	Max Ambient Operating Temp	
LXEM8-30HL-RFA-EDU	High Lumen	30K	RFA	11,851	94.8	125	45°C	
LXEM8-30HL-RA-EDU			RA	11,863	94.6	125.4	45°C	
LXEM8-30HL-DFA-EDU			DFA	12,428	94.6	131.4	45°C	
LXEM8-30HL-DCA-EDU			DCA	12,547	94.8	132.4	45°C	
LXEM8-35HL-RFA-EDU		35K	RFA	12,254	94.8	129.3	45°C	
LXEM8-35HL-RA-EDU			RA	12,267	94.6	129.7	45°C	
LXEM8-35HL-DFA-EDU			DFA	12,851	94.6	135.8	45°C	
LXEM8-35HL-DCA-EDU			DCA	12,973	94.8	136.9	45°C	
LXEM8-40HL-RFA-EDU		40K	RFA	12,444	94.8	131.3	45°C	
LXEM8-40HL-RA-EDU			RA	12,456	94.6	131.7	45°C	
LXEM8-40HL-DFA-EDU			DFA	13,049	94.6	137.9	45°C	
LXEM8-40HL-DCA-EDU			DCA	13,174	94.8	139	45°C	
LXEM8-50HL-RFA-EDU		50K	RFA	12,776	94.8	134.8	45°C	
LXEM8-50HL-RA-EDU			RA	12,789	94.6	135.2	45°C	
LXEM8-50HL-DFA-EDU			DFA	13,397	94.6	141.6	45°C	
LXEM8-50HL-DCA-EDU			DCA	13,525	94.8	142.7	45°C	
LXEM8-30VL-RA-EDU		Very High Lumen	30K	RA	14,747	123.4	119.5	40°C
LXEM8-30VL-RFA-EDU				RFA	14,789	123.2	120	40°C
LXEM8-30VL-DFA-EDU				DFA	15,512	123.4	125.7	40°C
LXEM8-30VL-DCA-EDU				DCA	15,613	123.4	126.5	40°C
LXEM8-35VL-RA-EDU	35K		RA	15,248	123.4	123.6	40°C	
LXEM8-35VL-RFA-EDU			RFA	15,292	123.2	124.1	40°C	
LXEM8-35VL-DFA-EDU			DFA	16,040	123.4	130	40°C	
LXEM8-35VL-DCA-EDU			DCA	16,143	123.4	130.8	40°C	
LXEM8-40VL-RA-EDU	40K		RA	15,484	123.4	125.5	40°C	
LXEM8-40VL-RFA-EDU			RFA	15,529	123.2	126	40°C	
LXEM8-40VL-DFA-EDU			DFA	16,288	123.4	132	40°C	
LXEM8-40VL-DCA-EDU			DCA	16,393	123.4	132.8	40°C	
LXEM8-50VL-RA-EDU	50K		RA	15,897	123.4	128.8	40°C	
LXEM8-50VL-RFA-EDU			RFA	15,943	123.2	129.4	40°C	
LXEM8-50VL-DFA-EDU			DFA	16,722	123.4	135.5	40°C	
LXEM8-50VL-DCA-EDU			DCA	16,830	123.4	136.4	40°C	
LXEM8-30XL-RFA-EDU	Xtra High Lumen		30K	RFA	19,558	182.4	107.2	30°C
LXEM8-30XL-RA-EDU				RA	19,678	182.8	107.7	30°C
LXEM8-30XL-DFA-EDU				DFA	20,716	182.8	113.3	30°C
LXEM8-30XL-DCA-EDU				DCA	20,847	183	113.9	30°C
LXEM8-35XL-RFA-EDU		35K	RFA	20,223	182.4	110.9	30°C	
LXEM8-35XL-RA-EDU			RA	20,348	182.8	111.3	30°C	
LXEM8-35XL-DFA-EDU			DFA	21,420	182.8	117.2	30°C	
LXEM8-35XL-DCA-EDU			DCA	21,556	183	117.8	30°C	
LXEM8-40XL-RFA-EDU		40K	RFA	20,536	182.4	112.6	30°C	
LXEM8-40XL-RA-EDU			RA	20,662	182.8	113	30°C	
LXEM8-40XL-DFA-EDU			DFA	21,752	182.8	119	30°C	
LXEM8-40XL-DCA-EDU			DCA	21,889	183	119.6	30°C	
LXEM8-50XL-RFA-EDU		50K	RFA	21,083	182.4	115.6	30°C	
LXEM8-50XL-RA-EDU			RA	21,213	182.8	116	30°C	
LXEM8-50XL-DFA-EDU			DFA	22,332	182.8	122.2	30°C	
LXEM8-50XL-DCA-EDU			DCA	22,473	183	122.8	30°C	

DIMENSIONS

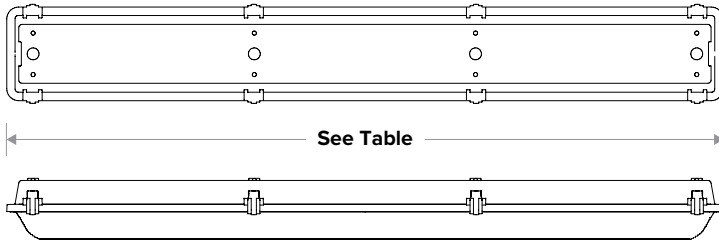

LXEM LENGTH DIMENSIONS								
Size	Lens	Length	Size	Lens	Length	Size	Lens	Length
2'	RFA	27 ² / ₃ "	4'	RFA	51 ¹ / ₂ "	8'	RFA	100"
	RA	27 ² / ₃ "		RA	51 ¹ / ₂ "		RA	N/A
	DFA	27 ² / ₃ "		DFA	51 ¹ / ₂ "		DFA	100"
	DCA	27 ² / ₃ "		DCA	51 ¹ / ₂ "		DCA	100"
	RFP	27 ² / ₃ "		RFP	51 ¹ / ₂ "		RFP	N/A
	RP	27 ² / ₃ "		RP	51 ¹ / ₂ "		RP	N/A

RFA Lens: 2', 4', 8', RFP Lens: 2', 4'

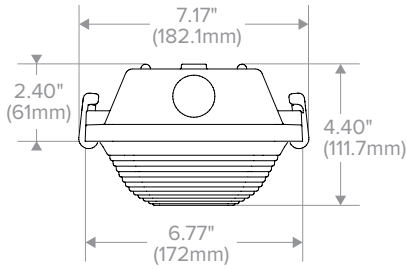

DFA or DCA Lens: 2', 4', 8'

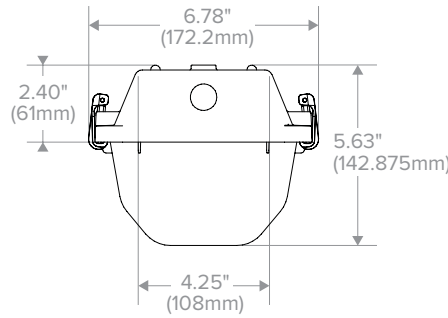

NOTE: All dimensions are in inches; dimensions and specifications are subject to change without notice. Please consult factory or check sample for verification.

PHOTOMETRY

LXEM4-50ML-RFA-EDU

LUMINAIRE DATA

Test No.	17905
Description	LXEM LED Enclosed and Gasketed, Extreme Environment 7" x 51" LED with frosted ribbed acrylic lens
Delivered Lumens	5306
Watts	42.00
Efficacy	126
Mounting	Surface
Spacing Criterion	0° = 1.24 90° = 1.40

ZONAL LUMEN SUMMARY

Zone	Lumens	% Luminaire
0-30	1268	23.9
0-40	2105	39.7
0-60	3766	71.0
0-90	5025	94.7
0-180	5306	100.0

POLAR GRAPH

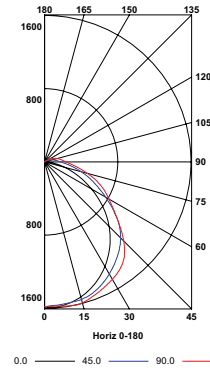

LXEM4-40HL-DFA-EDU

LUMINAIRE DATA

Test No.	17989
Description	LXEM LED Enclosed and Gasketed, Extreme Environment 7" x 51" LED with deep frosted acrylic lens
Delivered Lumens	6525
Watts	47.30
Efficacy	138
Mounting	Surface
Spacing Criterion	0° = 1.25 90° = 1.28

ZONAL LUMEN SUMMARY

Zone	Lumens	% Luminaire
0-30	1583	24.3
0-40	2594	39.8
0-60	4661	71.4
0-90	6235	95.6
0-180	6525	100.0

POLAR GRAPH

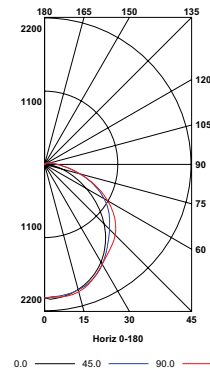

LXEM4-50XL-RA-EDU

LUMINAIRE DATA

Test No.	18012
Description	LXEM LED Enclosed and Gasketed, Extreme Environment 7" x 51" LED with ribbed clear acrylic lens
Delivered Lumens	10607
Watts	91.40
Efficacy	116
Mounting	Surface
Spacing Criterion	0° = 1.21 90° = 1.38

ZONAL LUMEN SUMMARY

Zone	Lumens	% Luminaire
0-30	2547	24
0-40	4252	40.1
0-60	7643	72.1
0-90	10073	95
0-180	10607	100.0

POLAR GRAPH

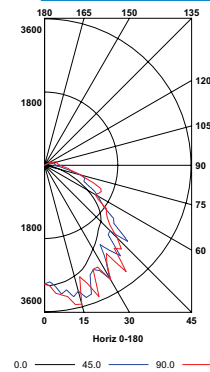

ADDITIONAL INFORMATION

DTS WIRING DIAGRAM (0-10V DIMMING DRIVER SHOWN)

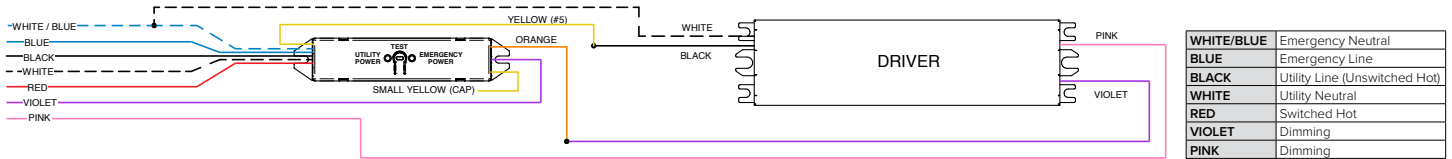

All product and company names, logos and product identifiers are trademarks™ or registered trademarks® of Hubbell Lighting, Inc. or their respective owners. Use of them does not necessarily imply any affiliation with or endorsement by such respective owners.