

Miniature Industrial relay 8 - 16 A



Automation for blinds, grilles and shutters



Elevators and lifts



Shipyards



Road / tunnel lighting



Hoists and cranes



Bottling plant



Control panels



Panels for electrical distribution

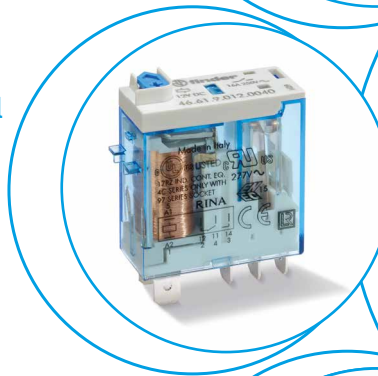
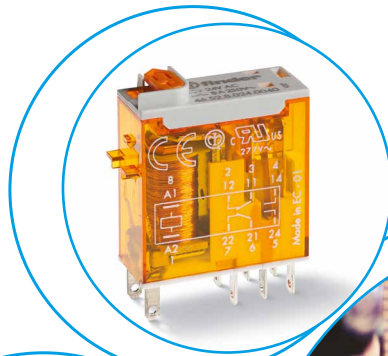

1 & 2 CO industrial style power relays
For socket mount or direct connection via
Faston connectors

Type 46.52

- 2 CO 8 A

Type 46.61

- 1 CO 16 A

- AC coils & DC coils
- Available with: lockable test button, mechanical indicator & LED indicator
- 8 mm, 6 kV (1.2/50 μs) isolation, coil-contacts
- Cadmium free contacts
- 97 series 35 mm rail (EN 60715) Screw, Screwless or Push-in terminals, and PCB mount sockets
- Coil Indication and EMC suppression modules 99 series and Timer module 86.30 options
- Optional alternative mounting adaptors
- European Patent

46.52



- 2 CO 8 A
- Plug-in/Solder terminals

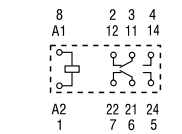

46.61



- 1 CO 16 A
- Plug-in/Faston 187

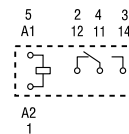

FOR UL RATINGS SEE:

"General technical information" page V

For outline drawing see page 6

Contact specification

Contact configuration		2 CO (DPDT)	1 CO (SPDT)
Rated current/Maximum peak current	A	8/15	16/25*
Rated voltage/Maximum switching voltage	V AC	250/440	250/440
Rated load AC1	VA	2000	4000
Rated load AC15 (230 V AC)	VA	350	750
Single phase motor rating (230 V AC)	kW	0.37	0.55
Breaking capacity DC1: 24/110/220 V	A	6/0.5/0.15	12/0.5/0.15
Minimum switching load	mW (V/mA)	300 (5/5)	300 (5/5)
Standard contact material		AgNi	AgNi

* With the AgSnO₂ material the maximum peak current is 80 A - 5 ms on normally open contact.

Coil specification

Nominal voltage (U _N)	V AC (50/60 Hz)	12 - 24 - 48 - 110 - 120 - 230 - 240	
	V DC	12 - 24 - 48 - 110 - 125	
Rated power	VA/W	1.2/0.5	1.2/0.5
Operating range	AC	(0.8...1.1)U _N	(0.8...1.1)U _N
	DC	(0.73...1.1)U _N	(0.73...1.1)U _N
Holding voltage	AC/DC	0.8 U _N / 0.4 U _N	0.8 U _N / 0.4 U _N
Must drop-out voltage	AC/DC	0.2 U _N / 0.1 U _N	0.2 U _N / 0.1 U _N

Technical data

Mechanical life AC/DC	cycles	10 · 10 ⁶	10 · 10 ⁶
Electrical life at rated load AC1	cycles	100 · 10 ³	100 · 10 ³
Operate/release time	ms	10/3	15/5
Insulation between coil and contacts (1.2/50 μs)	kV	6 (8 mm)	6 (8 mm)
Dielectric strength between open contacts	V AC	1000	1000
Ambient temperature range	°C	-40...+70	-40...+70
Environmental protection		RT II	RT II

Approvals (according to type)

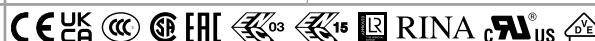

Ordering information

Example: 46 series Miniature industrial relay, 1 CO, 24 V DC coil, lockable test button and mechanical indicator.

A

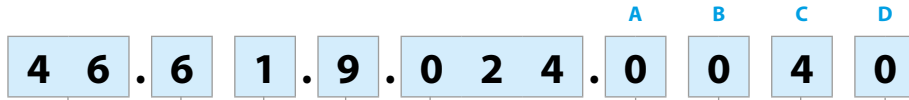

- Series** —————
- Type** —————
5 = Spade/blade solder terminal (2.5 x 0.5)mm
6 = Spade/blade terminal Faston 187 (4.8 x 0.5)mm
- No. of poles** —————
1 = 1 pole, 16 A
2 = 2 poles, 8 A
- Coil version** —————
9 = DC
8 = AC (50/60 Hz)
- Coil voltage** —————
See coil specifications

- A: Contact material**
0 = AgNi
4 = AgSnO₂ (46.61 only)
5 = AgNi + Au
- B: Contact circuit**
0 = CO (nPDT)

- D: Special versions**
0 = Standard
- C: Options**
2 = Mechanical indicator
4 = Lockable test button + mechanical indicator
54 = Lockable test button + LED (AC) + mechanical indicator
74 = Lockable test button + double LED (DC non-polarized) + mechanical indicator

Selecting features and options: only combinations in the same row are possible.
Preferred selections for best availability are shown in **bold**.

Type	Coil version	A	B	C	D
46.52	AC - DC	0 - 5	0	2 - 4	0
	AC	0 - 5	0	54	/
	DC	0 - 5	0	74	/
46.61	AC - DC	0 - 4 - 5	0	2 - 4	0
	AC	0 - 4 - 5	0	54	/
	DC	0 - 4 - 5	0	74	/

Special versions for Rail Applications on request

Descriptions: Options

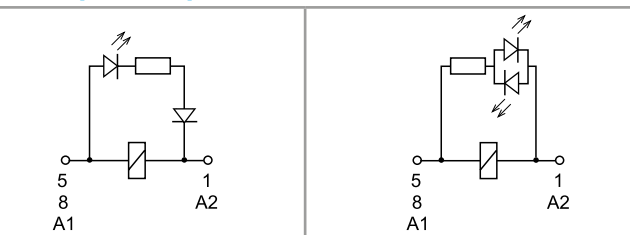

C: Option 54
LED (AC)

C: Option 74
LED (DC, non-polarized)

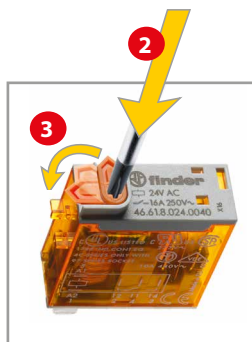

Lockable test button and mechanical flag indicator (0040, 0054, 0074)

The dual-purpose Finder test button can be used in two ways:

Case 1) The plastic pip (located directly below the test button) remains intact. In this case, when the test button is pushed, the contacts operate. When the test button is released the contacts return to their former state.

Case 2) The plastic pip is broken-off (using an appropriate cutting tool). In this case, (in addition to the above function), when the test button is pushed and rotated, the contacts are latched in the operating state, and remain so until the test button is rotated back to its former position.

In both cases ensure that the test button actuation is swift and decisive.



Technical data

Insulation according to EN 61810-1		1 pole		2 pole	
Nominal voltage of supply system	V AC	230/400		230/400	
Rated insulation voltage	V AC	250	400	250	400
Pollution degree		3	2	3	2
Insulation between coil and contact set					
Type of Insulation		Reinforced (8 mm)		Reinforced (8 mm)	
Overvoltage category		III		III	
Rated impulse voltage	kV (1.2/50 μ s)	6		6	
Dielectric strength	V AC	4000		4000	
Insulation between adjacent contacts					
Type of insulation		—		Basic	
Overvoltage category		—		III	
Rated impulse voltage	kV (1.2/50 μ s)	—		4	
Dielectric strength	V AC	—		2000	
Insulation between open contacts					
Type of disconnection		Micro-disconnection		Micro-disconnection	
Dielectric strength	V AC/kV (1.2/50 μ s)	1000/1.5		1000/1.5	
Insulation between coil terminals					
Rated impulse voltage (surge) differential mode (according to EN 61000-4-5)	kV (1.2/50 μ s)	2			
Other data		46.61		46.52	
Bounce time: NO/NC	ms	2/6		1/4	
Vibration resistance (10...150)Hz: NO/NC	g	20/12		20/15	
Shock resistance	g	20		20	
Power lost to the environment	without contact current	W	0.6		0.6
	with rated current	W	1.6		2
Recommended distance between relays mounted on PCB	mm	≥ 5			

Contact specification

F 46 - Electrical life (AC) v contact current

Type 46.52

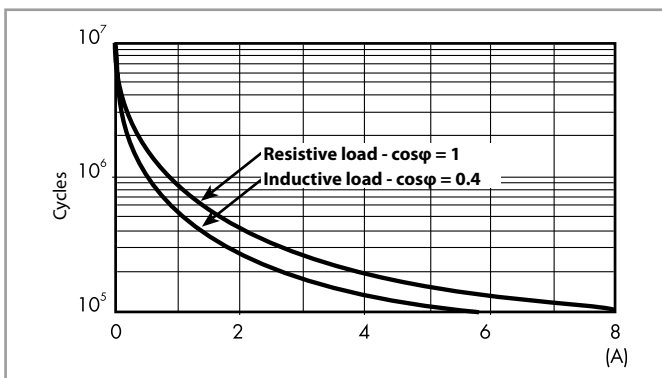

F 46 - Electrical life (AC) v contact current

Type 46.61

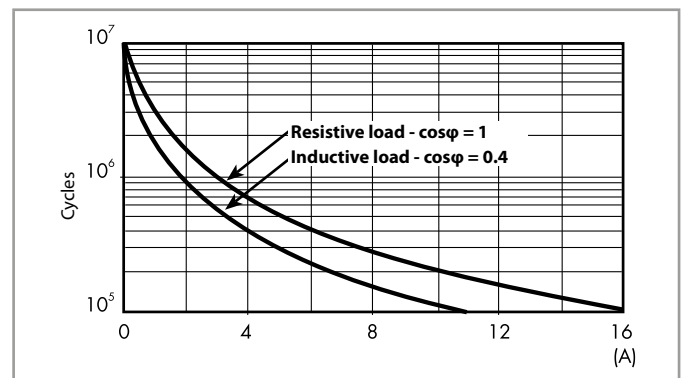

H 46 - Maximum DC1 breaking capacity

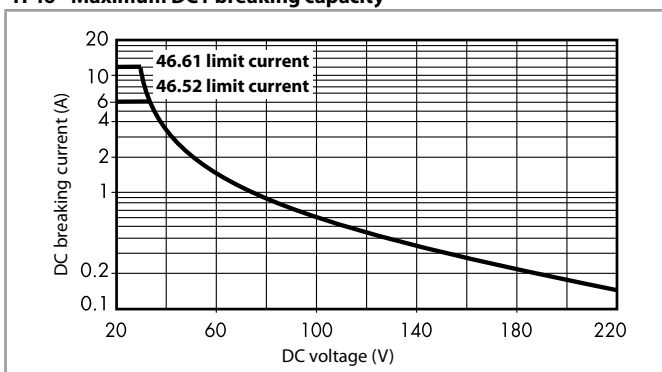

- When switching a resistive load (DC1) having voltage and current values under the curve, an electrical life of $\geq 100 \cdot 10^3$ can be expected.
 - In the case of DC13 loads, the connection of a diode in parallel with the load will permit a similar electrical life as for a DC1 load.
- Note: the release time for the load will be increased.

Coil specifications

DC coil data

Nominal voltage U_N V	Coil code	Operating range		Resistance R Ω	Rated coil consumption I at U_N mA
		U_{min} V	U_{max} V		
12	9.012	8.8	13.2	300	40
24	9.024	17.5	26.4	1200	20
48	9.048	35	52.8	4800	10
110	9.110	80	121	23500	4.7
125	9.125	91.2	138	32000	3.9

AC coil data

Nominal voltage U_N V	Coil code	Operating range		Resistance R Ω	Rated coil consumption I at U_N mA
		U_{min} V	U_{max} V		
12	8.012	9.6	13.2	80	90
24	8.024	19.2	26.4	320	45
48	8.048	38.4	52.8	1350	21
110	8.110	88	121	6900	9.4
120	8.120	96	132	9000	8.4
230	8.230	184	253	28000	5
240	8.240	192	264	31500	4.1

R 46 - DC coil operating range v ambient temperature

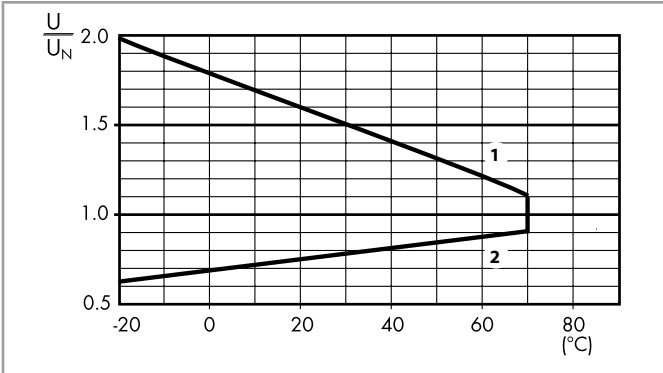

- 1 - Max. permitted coil voltage.
2 - Min. pick-up voltage with coil at ambient temperature.

R 46 - AC coil operating range v ambient temperature

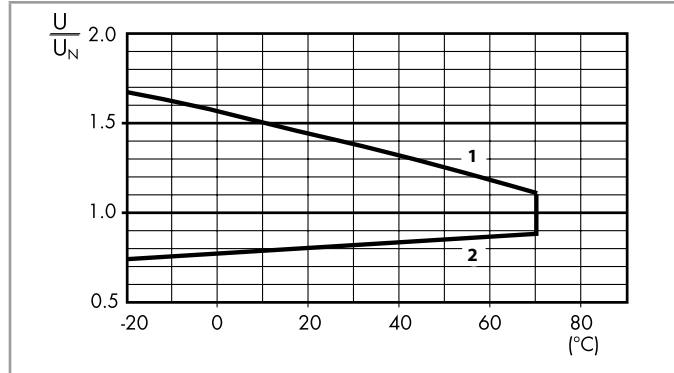

- 1 - Max. permitted coil voltage.
2 - Min. pick-up voltage with coil at ambient temperature.

Outline drawings

Type 46.52

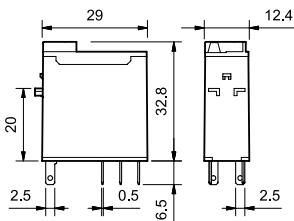

Type 46.61

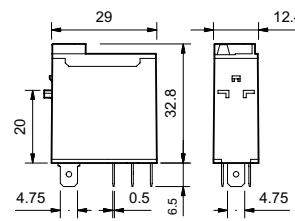

Accessories



046.05

Flange mount adaptor for relays types 46.52 and 46.61

046.05

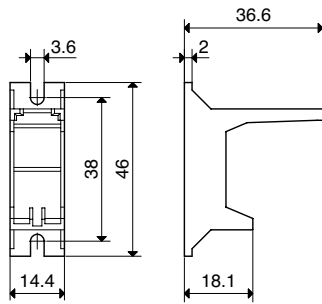

046.05

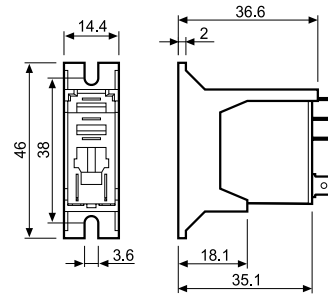

046.05 with relay

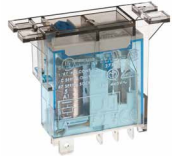

046.05 with relay



046.07

35 mm rail adaptor for relays types 46.52 and 46.61

046.07

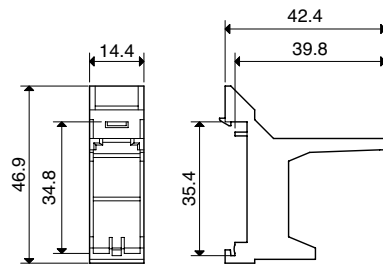

046.07

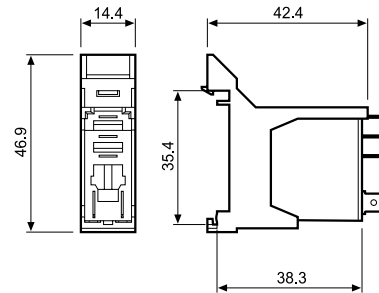

046.07 with relay



046.07 with relay

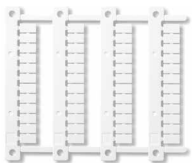

060.48

Sheet of marker tags (CEMBRE Thermal transfer printers) for relays types 46.52 and 46.61, (48 tags) 6 x 12 mm

060.48

A

A

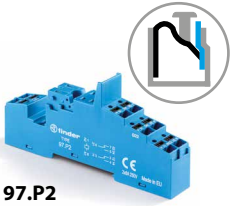

97.P2

Approvals
(according to type):



097.01

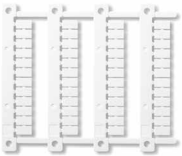

060.48

Push-in terminal socket panel or 35 mm rail (EN 60715) mount	97.P1	97.P2
For relay type	46.61	46.52
Accessories		
Plastic retaining and release clip (supplied with socket - packaging code SPA)		097.01
Metal retaining clip		097.71
Identification tag		095.00.4
8-way jumper link		097.58
2-way jumper link		097.52
2-way jumper link		097.42
Marker tag holder		097.00
Modules (see table below)		99.02
Timer modules (see table below)		86.30
Sheet of marker tags for marker tag holder 097.00, 48 tags, 6 x 12 mm, for CEMBRE thermal transfer printers		060.48
Technical data		
Rated values	10 A-250 V AC	8 A-250 V AC
Dielectric strength	6 kV (1.2/50 μs) between coil and contacts	
Protection category	IP 20	
Ambient temperature	°C -40...+70	
Wire strip length	mm 10	
Min. wire size for 97.P1 and 97.P2 socket	solid wire	stranded wire
	mm ² 0.5	0.5
	AWG 21	21
Max. wire size for 97.P1 and 97.P2 socket	solid wire	stranded wire
	mm ² 2 x 1.5 / 1 x 2.5	2 x 1.5 / 1 x 2.5
	AWG 2 x 16 / 1 x 14	2 x 16 / 1 x 14

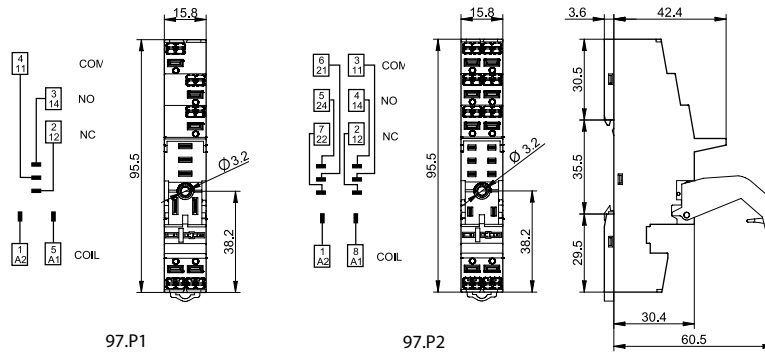

097.58

8-way jumper link for 97.P1 and 97.P2 sockets	097.58
Rated values	10 A - 250 V

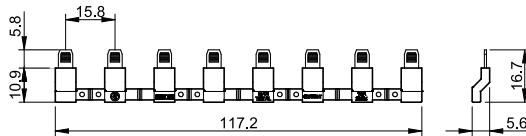

097.52

2-way jumper link for 97.P1 and 97.P2 sockets	097.52
Rated values	10 A - 250 V

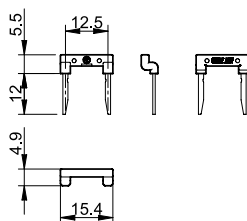



097.42

2-way jumper link for 97.P1 and 97.P2 sockets	097.42
Rated values	10 A - 250 V

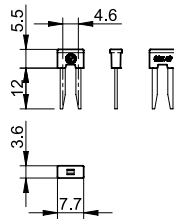

097.00

Marker tag holder for 97.P1 and 97.P2 sockets	097.00
--	--------

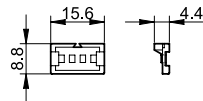

86.30

86 series timer modules	
(12...24)V AC/DC; Bi-function: AI, DI; (0.05 s...100 h)	86.30.0.024.0000
(110...125)V AC; Bi-function: AI, DI; (0.05 s...100 h)	86.30.8.120.0000
(230...240)V AC; Bi-function: AI, DI; (0.05 s...100 h)	86.30.8.240.0000

Approvals (according to type):



99.02

99.02 coil indication and EMC suppression modules for 97.P1 and 97.P2 sockets		
Diode (+A1, standard polarity)	(6...220)V DC	99.02.3.000.00
LED	(6...24)V DC/AC	99.02.0.024.59
LED	(28...60)V DC/AC	99.02.0.060.59
LED	(110...240)V DC/AC	99.02.0.230.59
LED + Diode (+A1, standard polarity)	(6...24)V DC	99.02.9.024.99
LED + Diode (+A1, standard polarity)	(28...60)V DC	99.02.9.060.99
LED + Diode (+A1, standard polarity)	(110...220)V DC	99.02.9.220.99
LED + Varistor	(6...24)V DC/AC	99.02.0.024.98
LED + Varistor	(28...60)V DC/AC	99.02.0.060.98
LED + Varistor	(110...240)V DC/AC	99.02.0.230.98
RC circuit	(6...24)V DC/AC	99.02.0.024.09
RC circuit	(28...60)V DC/AC	99.02.0.060.09
RC circuit	(110...240)V DC/AC	99.02.0.230.09
Residual current by-pass*	(110...240)V AC	99.02.8.230.07

* Additional 0.9 W power dissipation

Approvals (according to type):



DC Modules with non-standard polarity (+A2) on request.



97.11

Approvals
(according to type):



97.12

Approvals
(according to type):



PCB socket	97.11 (blue)	97.12 (blue)
For relay type	46.61	46.52
Technical data		
Rated values	12 A - 250 V (see diagram L97)	8 A - 250 V
Dielectric strength	6 kV (1.2/50 µs) between coil and contacts	
Protection category	IP 20	
Ambient temperature	°C -40...+70	

L 97 - Rated current v ambient temperature
(for 46.61 relay/97.11 socket combination)

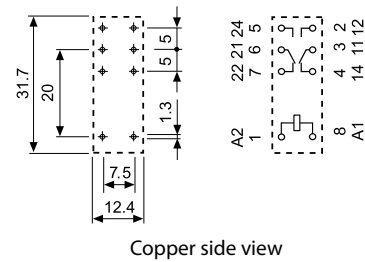
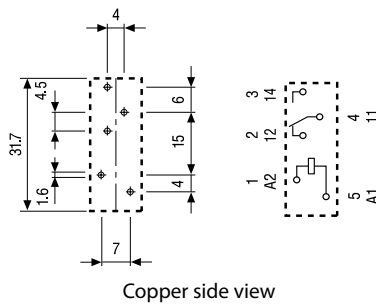
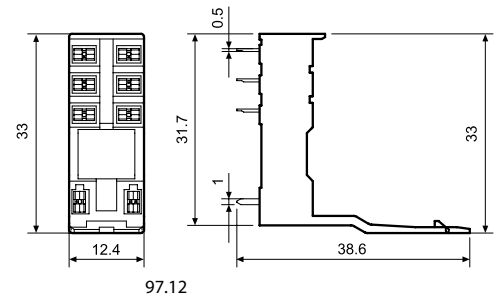
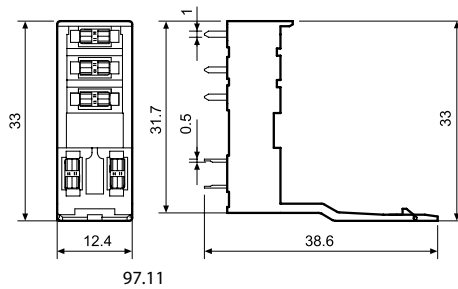
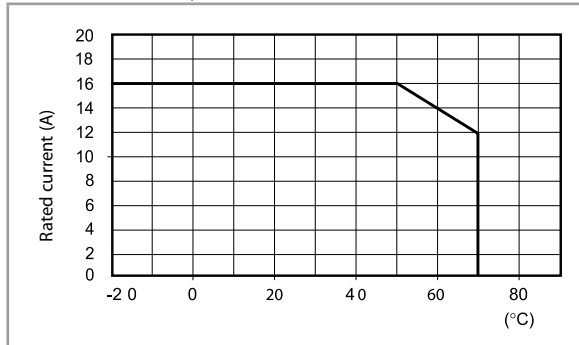

Packaging codes

How to code and identify retaining clip and packaging options for sockets.

Example:



A Standard packaging

SM Metal retaining clip
SP Plastic retaining clip

