

# Miniature plug-in timers 7 - 10 A



Timers and  
lighting controls



Medical and  
dentistry



Drying kilns



Elevators  
and lifts



Panels for  
electrical  
distribution



Control panels



85  
SERIES



**Plug-in timer**

- 85.02 - 2 Pole 10 A**
- 85.03 - 3 Pole 10 A**
- 85.04 - 4 Pole 7 A**

- Multifunctions
- Seven time scales, from 0.05 s to 100 h
- 94 series sockets for 35 mm rail (EN 60715) mount with push-in and screw terminal

**85.02**

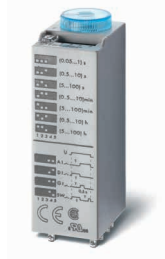

- 2 pole, 10 A
- AC/DC supply non polarized
- Plug-in for use with 94 series sockets

- AI:** On-delay
- DI:** Interval
- SW:** Symmetrical flasher (starting pulse on)
- GI:** Pulse delayed

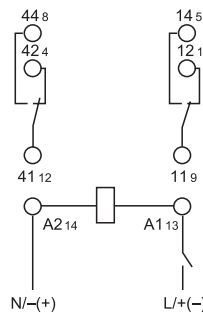

Wiring diagram (without control signal)

**85.03**



- 3 pole, 10 A
- AC/DC supply non polarized
- Plug-in for use with 94 series sockets

- AI:** On-delay
- DI:** Interval
- SW:** Symmetrical flasher (starting pulse on)
- GI:** Pulse delayed

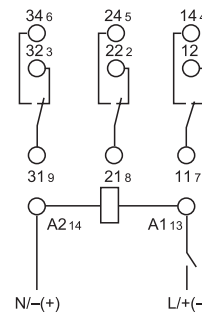

Wiring diagram (without control signal)

**85.04**

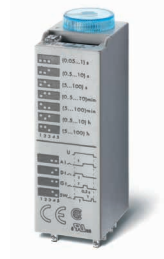

- 4 pole, 7 A
- AC/DC supply non polarized
- Plug-in for use with 94 series sockets

- AI:** On-delay
- DI:** Interval
- SW:** Symmetrical flasher (starting pulse on)
- GI:** Pulse delayed

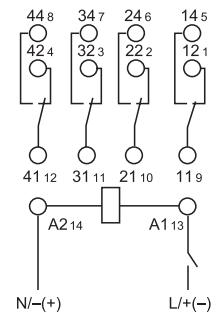

Wiring diagram (without control signal)

FOR UL RATINGS SEE:  
"General technical information" page V

For outline drawing see page 4

**Contact specification**

Contact configuration		2 CO (DPDT)	3 CO (3PDT)	4 CO (4PDT)
Rated current/Maximum peak current	A	10/20	10/20	7/15
Rated voltage/Maximum switching voltage	V AC	250/400	250/400	250/250
Rated load AC1	VA	2500	2500	1750
Rated load AC15 (230 V AC)	VA	500	500	350
Single phase motor rating (230 V AC)	kW	0.37	0.37	0.125
Breaking capacity DC1: 24/110/220 V	A	10/0.25/0.12	10/0.25/0.12	7/0.25/0.12
Minimum switching load	mW (V/mA)	300 (5/5)	300 (5/5)	300 (5/5)
Standard contact material		AgNi	AgNi	AgNi

**Supply specification**

Nominal voltage (U <sub>N</sub> )	V AC (50/60 Hz)	230...240	230...240	230...240
	V AC/DC	12 - 24 - 48 - 110...125 (non polarized)		
Rated power AC/DC	VA (50 Hz)/W	2/2	2/2	2/2
Operating range	AC	(0.85...1.1)U <sub>N</sub>	(0.85...1.1)U <sub>N</sub>	(0.85...1.1)U <sub>N</sub>
	DC	(0.85...1.1)U <sub>N</sub>	(0.85...1.1)U <sub>N</sub>	(0.85...1.1)U <sub>N</sub>

**Technical data**

Specified time range		(0.05...1)s, (0.5...10)s, (5...100)s, (0.5...10)min, (5...100)min, (0.5...10)h, (5...100)h		
Repeatability	%	± 2	± 2	± 2
Recovery time	ms	≤ 20	≤ 20	≤ 20
Minimum control impulse	ms	—	—	—
Setting accuracy-full range	%	± 5	± 5	± 5
Electrical life at rated load in AC1	cycles	200 · 10 <sup>3</sup>	200 · 10 <sup>3</sup>	150 · 10 <sup>3</sup>
Ambient temperature range	°C	-20...+60	-20...+60	-20...+60
Protection category		IP 40	IP 40	IP 40

**Approvals (according to type)**



### Ordering information

Example: 85 series timer, 4 CO (4PDT), 24 V AC/DC supply voltage, AI, DI, GI, SW functions.

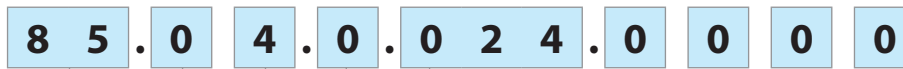

**Series** ————  
**Type** ————  
 0 = Multifunction (AI, DI, GI, SW)\*  
 \* AI = On-delay  
 DI = Interval  
 GI = Pulse delayed  
 SW = Symmetrical flasher  
 (starting pulse on)

**Supply voltage**  
 012 = 12 V AC/DC  
 024 = 24 V AC/DC  
 048 = 48 V AC/DC  
 125 = (110...125)V AC/DC  
 240 = (230...240)V AC  
**Supply version**  
 0 = AC (50/60 Hz)/DC  
 8 = AC (50/60 Hz) for 240V only

**No. of poles** ————  
 2 = 2 pole - 10 A  
 3 = 3 pole - 10 A  
 4 = 4 pole - 7 A

### Technical data

Insulation				
Dielectric strength			<b>85.02, 85.03</b>	<b>85.04</b>
	between input and output circuit	V AC	2000	2000
	between open contacts	V AC	1000	1000
	between adjacent contacts	V AC	2000	1550
Insulation (1.2/50 μs) between input and output		kV	6	4
EMC specifications				
<b>Type of test</b>			<b>Reference standard</b>	
Electrostatic discharge	contact discharge		EN 61000-4-2	n.a.
	air discharge		EN 61000-4-2	8 kV
Radio-frequency electromagnetic field (80 ÷ 1000 MHz)			EN 61000-4-3	15 V/m
Fast transients (burst) (5-50 ns, 5 kHz) on Supply terminals			EN 61000-4-4	4 kV
Surges (1.2/50 μs) on Supply terminals	common mode		EN 61000-4-5	4 kV
	differential mode		EN 61000-4-5	2 kV
Radio-frequency common mode (0.15 ÷ 80 MHz) on Supply terminals			EN 61000-4-6	10 V
Power-frequency (50 Hz)			EN 61000-4-8	30 A/m
Radiated and conducted emission			EN 55022	class B
Other data				
Power lost to the environment	without contact current	W	1.6	
	with rated current	W	3.7 (85.02)	4.7 (85.03) 3.6 (85.04)

### Outline drawings

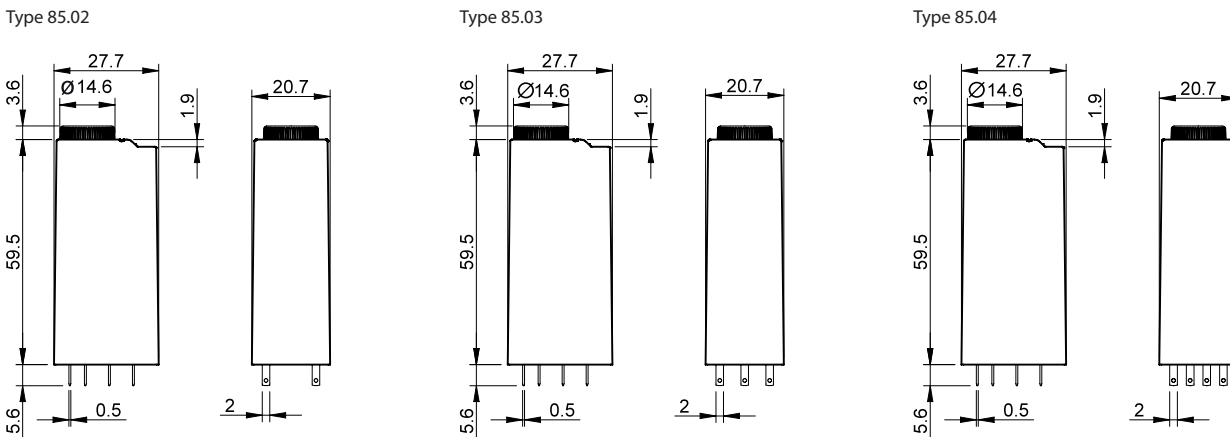

### Times scales

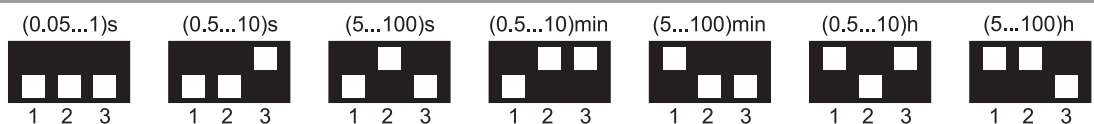

NOTE: time scales and functions must be set before energising the timer.

**Functions**

**U** = Supply voltage  
 = Output contact

LED	Supply voltage	NO (SPDT-NO) output contact	Contacts	
			Open	Closed
	OFF	Open	x1 - x4	x1 - x2
	ON	Open	x1 - x4	x1 - x2
	ON	Open (Timing in Progress)	x1 - x4	x1 - x2
	ON	Closed	x1 - x2	x1 - x4

**Wiring diagram**

Type: 85.02, 85.03, 85.04

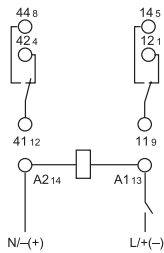

85.02

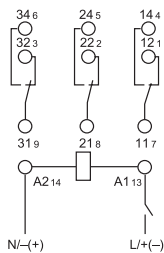

85.03

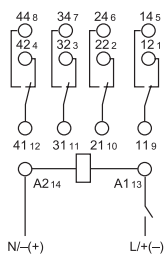

85.04

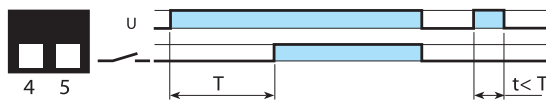

**(AI) On-delay.**

Apply power to timer. Output contacts transfer after preset time has elapsed. Reset occurs when power is removed.

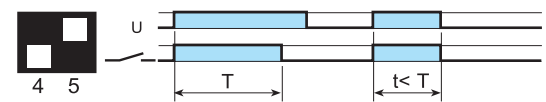

**(DI) Interval.**

Apply power to timer. Output contacts transfer immediately. After the preset time has elapsed, contacts reset.



**(GI) Pulse delayed.**

Apply power to timer. Output contacts transfer after preset time has elapsed. Reset occurs after a fixed time of 0.5 s.

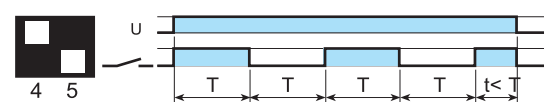

**(SW) Symmetrical flasher (starting pulse on).**

Apply power to timer. Output contacts transfer immediately and cycle between ON and OFF for as long as power is applied. The ratio is 1:1 (time on = time off).

**U** = Supply voltage  
**S** = Signal switch  
**U<sub>c</sub>** = Supply voltage to the timer  
**11-14** = Self-holding contact  
 = Output contact

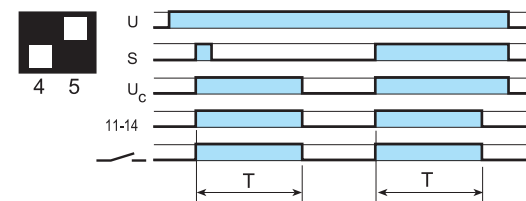

**Signal ON Pulse**

On momentary closure of Signal Switch (S) > 50 ms, the output contacts transfer and remain so (with self-holding on contact 11-14) for the duration of the preset delay, after which they reset.

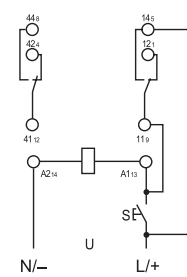

85.02

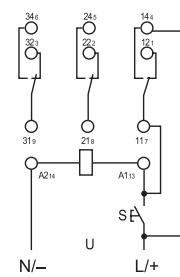

85.03

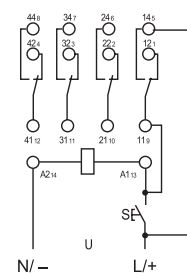

85.04



94.P4

Approvals  
(according to type):

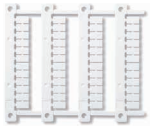

060.48

<b>Push-in terminal socket</b> panel or 35 mm (EN 60715) rail mount	<b>94.P3 Blue</b>	<b>94.P4 Blue</b>
For timer type	85.03	85.02, 85.04
<b>Accessories</b>		
Metal retaining clip		094.81
6-way jumper link		094.56
Identification tag		094.00.4
2-way jumper link		094.52.1
2-way jumper link		097.52
Marker tag holder		097.00
Sheet of marker tags for marker tag holder 097.00, 48 tags, 6 x 12 mm for CEMBRE thermal transfer printers		060.48
<b>Technical data</b>		
Rated values	10 A - 250 V	
Dielectric strength	2 kV AC	
Protection category	IP 20	
Ambient temperature	°C -40...+70	
Wire strip length	mm 8	
Min. wire size for 94.P3 and 94.P4 sockets	solid wire	stranded wire
	mm <sup>2</sup> 0.5	0.5
	AWG 21	21
Max. wire size for 94.P3 and 94.P4 sockets	solid wire	stranded wire
	mm <sup>2</sup> 2 x 1.5 / 1 x 2.5	2 x 1.5 / 1 x 2.5
	AWG 2 x 18 / 1 x 14	2 x 18 / 1 x 14

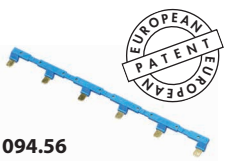
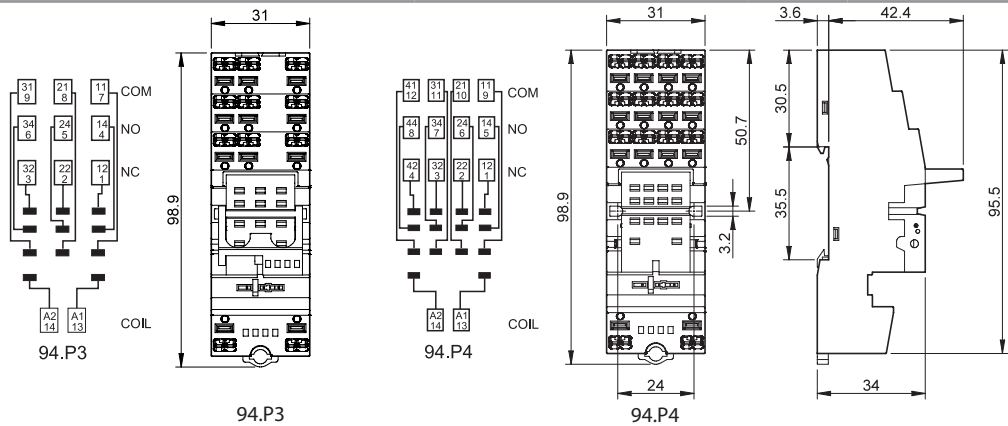

094.56



<b>6-way jumper link</b> for 94.P3 and 94.P4 sockets	094.56 (blue)
Rated values	10 A - 250 V

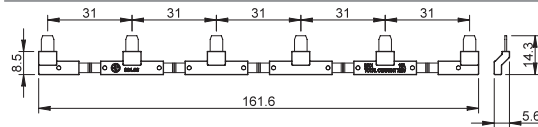

094.52.1

<b>2-way jumper link</b> for 94.P3 and 94.P4 sockets	094.52.1
Rated values	10 A - 250 V

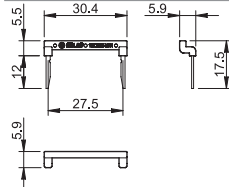

097.52

<b>2-way jumper link</b> for 94.P3 and 94.P4 sockets	097.52
Rated values	10 A - 250 V

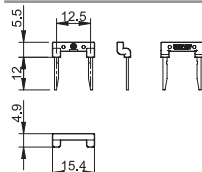

097.00

<b>Marker tag holder</b> for 94.P3 and 94.P4 sockets	097.00
--	--------

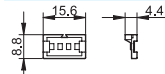



94.04

Approvals  
(according to type):

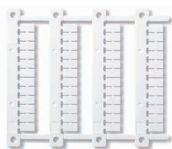

060.48

Screw terminal (Box clamp) socket panel or 35 mm (EN 60715) rail mount	94.02 Blue	94.02.0 Black	94.03 Blue	94.03.0 Black	94.04 Blue	94.04.0 Black
For timer type	85.02		85.03		85.04	
<b>Accessories</b>						
Metal retaining clip	094.81					
6-way jumper link	094.06	094.06.0	094.06	094.06.0	094.06	094.06.0
Identification tag	094.00.4					
Marker tag holder	097.00					
Sheet of marker tags marker tag holder 097.00, 48 tags, 6 x 12 mm for CEMBRE thermal transfer printers	060.48					
<b>Technical data</b>						
Rated values	10 A - 250 V					
Dielectric strength	2 kV AC					
Protection category	IP 20					
Ambient temperature	°C -40...+70					
Screw torque	Nm 0.5					
Wire strip length	mm 8					
Max. wire size for 94.02/03/04 sockets	solid wire			stranded wire		
	mm <sup>2</sup> 1 x 6 / 2 x 2.5			1 x 4 / 2 x 2.5		
	AWG 1 x 10 / 2 x 14			1 x 12 / 2 x 14		

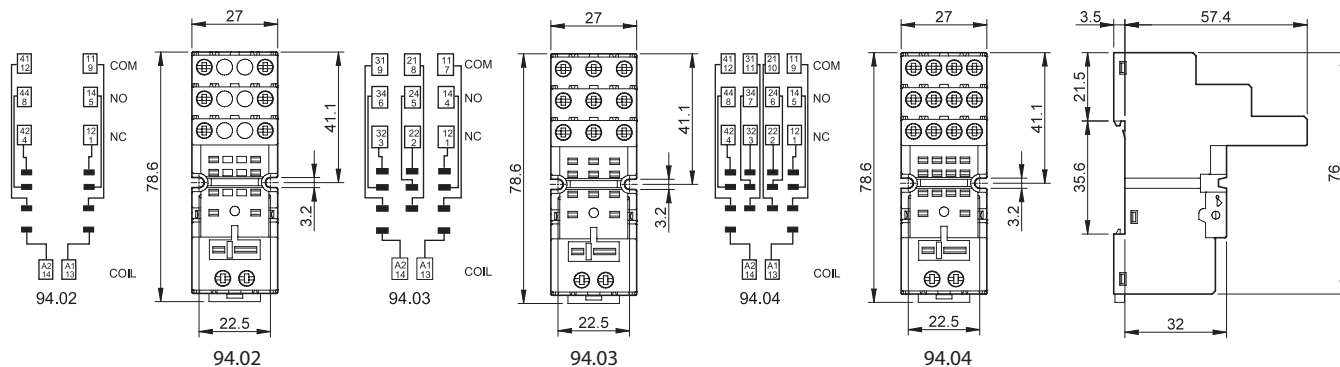

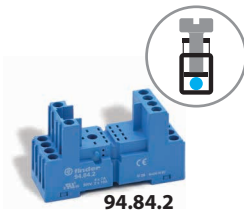

94.84.2

Approvals  
(according to type):



<b>Screw terminal (Box clamp) socket panel or 35 mm (EN 60715) rail mount</b>	<b>94.84.2</b>	<b>94.84.20</b>
For timer type	Blue	Black
	85.02, 85.04	
<b>Accessories</b>		
Metal retaining clip (supplied with socket - packaging code SMA)		094.81
6-way jumper link	094.06	094.06.0
Identification tag		094.80.3
<b>Technical data</b>		
Rated values	10 A - 250 V	
Dielectric strength	2 kV AC	
Protection category	IP 20	
Ambient temperature	°C -40...+70	
Screw torque	Nm	0.5
Wire strip length	mm	7
Max. wire size for 94.84.2 socket		
	mm <sup>2</sup>	solid wire      stranded wire
	AWG	1 x 6 / 2 x 2.5      1 x 4 / 2 x 2.5
	1 x 10 / 2 x 14	1 x 12 / 2 x 14

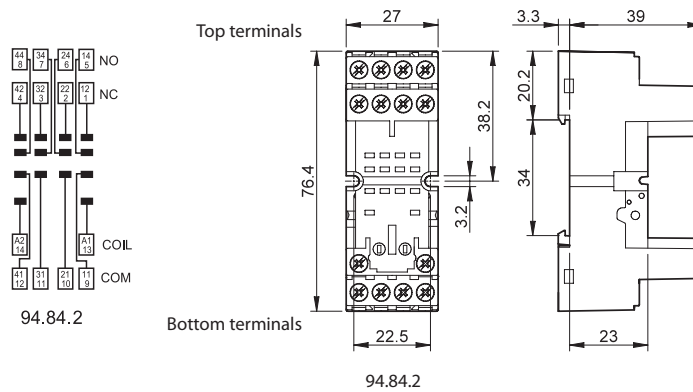

094.06



<b>6-way jumper link for 94.84.2 socket</b>	094.06 (blue)	094.06.0 (black)
Rated values	10 A - 250 V	

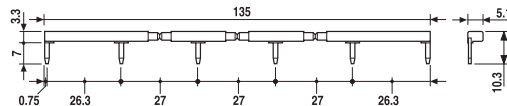





94.94.3

Approvals  
(according to type):



<b>Screw terminal (Box clamp) socket</b> panel or 35 mm rail mount	<b>94.92.3 (blue)</b>	<b>94.92.30 (black)</b>	<b>94.94.3 (blue)</b>	<b>94.94.30 (black)</b>
For timer type	85.02		85.04	
<b>Accessories</b>				
Metal retaining clip	094.81			
6-way jumper link	094.06	094.06.0	094.06	094.06.0
Identification tag	094.80.3			
<b>Technical data</b>				
Rated values	10 A - 250 V			
Dielectric strength	2 kV AC			
Protection category	IP 20			
Ambient temperature	°C	-25...+70		
Screw torque	Nm	0.5		
Wire strip length	mm	8		
Max. wire size for 94.92.3 and 94.94.3 sockets		solid wire		stranded wire
	mm <sup>2</sup>	1 x 6 / 2 x 2.5		1 x 4 / 2 x 2.5
	AWG	1 x 10 / 2 x 14		1 x 12 / 2 x 14

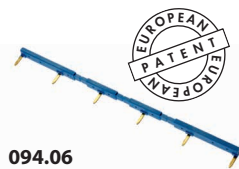
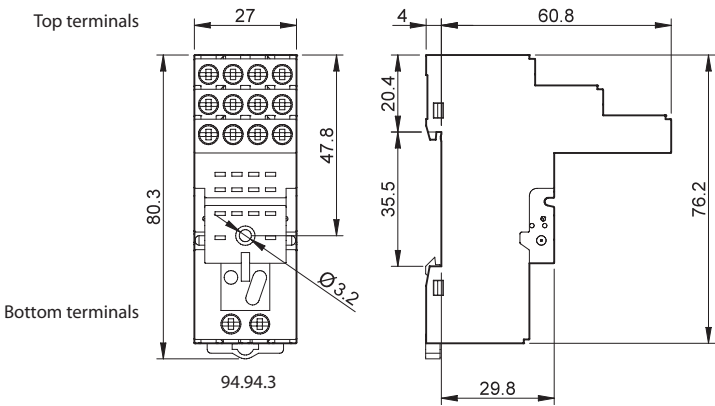
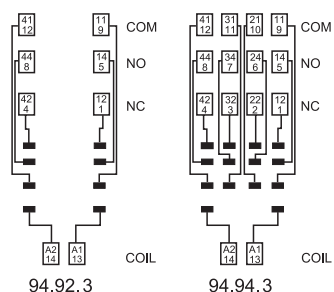

094.06



<b>6-way jumper link</b> for 94.92.3 and 94.94.3 sockets	094.06 (blue)	094.06.0 (black)
Rated values	10 A - 250 V	

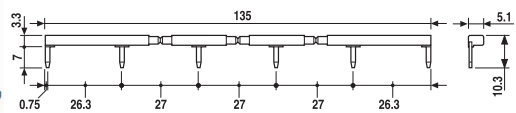



94.74

Approvals  
(according to type):



<b>Screw terminal (Plate clamp) socket</b> panel or 35 mm rail (EN 60715) mount	<b>94.72</b> <b>Blue</b>	<b>94.72.0</b> <b>Black</b>	<b>94.73</b> <b>Blue</b>	<b>94.73.0</b> <b>Black</b>	<b>94.74</b> <b>Blue</b>	<b>94.74.0</b> <b>Black</b>
For timer type	85.02		85.03		85.02, 85.04	

<b>Accessories</b>	
Metal retaining clip (supplied with timer)	094.81

<b>Screw terminal socket</b> panel or 35 mm rail (EN 60715) mount	<b>94.82</b> <b>Blue</b>	<b>94.82.0</b> <b>Black</b>
For timer type	85.02	

<b>Accessories</b>	
Metal retaining clip (supplied with timer)	094.81

**Technical data**

Rated values	10 A - 250 V	
Dielectric strength	2 kV AC	
Protection category	IP 20	
Ambient temperature	°C -40...+70	
Screw torque	Nm	0.5
Wire strip length	mm 8 (94.72, 94.73, 94.74)	9 (94.82)
Max. wire size for 94.72, 94.73, 94.74 and 94.82 sockets	solid wire	
	mm <sup>2</sup>	1 x 2.5 / 2 x 1.5
	AWG	1 x 14 / 2 x 16



94.82

Approvals  
(according to type):

